

YOUR  
OWN  
STYLE

**INDA**

## ACCESSORI

LISTINO PREZZI  
PRICE LIST  
TARIF  
TARIFA DE PRECIOS

**22F/€**



 **inda**<sup>®</sup>  
bathroom interiors





Gentile Cliente,

con passione progettiamo mobili, specchi, accessori e cabine doccia per sale da bagno, dove estetica e funzionalità si sposano per creare una sintesi vincente.

Come nella presente collezione Accessori, pensata per soddisfare una crescente domanda di qualità, eleganza e facilità d'inserimento in qualunque contesto di stile e configurazione del bagno.

Ti ringraziamo per aver scelto Inدا, una marca che dal 1944 propone il design italiano nel mondo.

Presidente  
Denis Venturato

Dear Customer,

our passion is to design furniture, mirrors, accessories and shower boxes for bathrooms, where aesthetics and functionality create a winning combination.

This is evident in Accessories, the current collection, designed to satisfy a growing demand for quality, elegance and ease of integration in any bathroom, regardless of the style and configuration.

We thank you for choosing Inدا, a brand that has been promoting Italian design in the world since 1944.

The President  
Denis Venturato

Cher client,

Nous concevons avec passion des meubles, miroirs, accessoires et cabines de douche pour salles de bain, où l'esthétique se conjugue à la fonctionnalité pour créer une composition réussie.

Cette collection d'Accessoires, conçue pour répondre à une demande croissante de qualité, d'élégance et de facilité d'insertion, quelle que soit le style et la configuration de la salle de bain, en est un parfait exemple.

Nous vous remercions d'avoir choisi Inدا, une marque qui depuis 1944 porte le design italien dans le monde entier.

Le Président  
Denis Venturato

Estimado Cliente:

Con verdadera pasión, proyectamos muebles, espejos, accesorios y cabinas de ducha, para baños en los que la estética y la funcionalidad se combinan para crear una síntesis exitosa.

Un ejemplo es la colección de Accesorios, concebida para satisfacer una creciente demanda de calidad, elegancia y facilidad de integración en cualquier estilo y configuración del baño.

Le agradecemos que haya elegido a Inدا, una marca que desde 1944 propone el diseño italiano en el mundo.





Presidente  
Denis Venturato



**INTRODUZIONE / INTRODUCTION  
INTRODUCTION / INTRODUCCIÓN**

<b>History</b>	pag.	VI
<b>Total living</b>	pag.	VIII
<b>Come comporre il codice How to create a code Comment composer le code Como componer los códigos</b>	pag.	X
<b>Finiture Finishes Finitions Acabados</b>	pag.	XI

**ACCESSORI / ACCESSORIES  
ACCESSOIRES / ACCESORIOS**

<b>MY ART</b>		pag.	XVIII
<b>MY LOVE</b>		pag.	10
<b>MY WAY</b>		pag.	16
<b>MY LIKE</b>		pag.	20
<b>MY SECRET_8000</b>		pag.	24
<b>CLAIRE_7100</b>	 	pag.	40
<b>INDISSIMA_8800</b>	 	pag.	48
<b>INDISSIMA CHROME_8800</b>	 	pag.	62
<b>GEALUNA_1000</b>	  	pag.	74
<b>MITO_2000</b>	 	pag.	88
<b>DIVO_1500</b>		pag.	102
<b>LEA_1800</b>	 	pag.	112
<b>ONE_2400</b>		pag.	130
<b>TOUCH_4600</b>		pag.	142
<b>RAFFAELLA_3200</b>		pag.	156
<b>FORUM QUADRA_3000</b>		pag.	164
<b>FORUM_3600</b>	 	pag.	174
<b>COLORELLA_2300</b>		pag.	186
<b>HOTELLERIE</b>		pag.	200
<b>MY MIRROR</b>		pag.	242
<b>COMFORT_H900</b>		pag.	252

**ACCESSORI / ACCESSORIES  
ACCESSOIRES / ACCESSORIOS**

<b>Maniglioni</b> <b>Grab-bars</b> <b>Barres d'appui</b> <b>Manillones</b>		pag. 260
<b>Sgabelli</b> <b>Stools</b> <b>Tabourets</b> <b>Taburetes</b>		pag. 270
<b>Cestini</b> <b>Basket</b> <b>Paniers porte-savon</b> <b>Jaboneras</b>	 	pag. 274
<b>Piantane</b> <b>Stands</b> <b>Accessoire sur pieds</b> <b>Toalleros de pie</b>		pag. 290
<b>Complementi doccia</b> <b>Complements</b> <b>Compléments</b> <b>Complementos</b>		pag. 298
<b>Serie da appoggio</b> <b>Tabletop series</b> <b>Séries à poser</b> <b>Series de apoyo</b>		pag. 306
<b>Ricambi</b> <b>Spare parts</b> <b>Pièces de rechange</b> <b>Repuestos</b>		pag. 314

**INFO & SERVICE**

<b>Qualità certificata</b> <b>Certified quality</b> <b>Qualité certifiée</b> <b>Calidad certificada</b>	pag. 344
<b>Legenda simboli</b> <b>Symbol key</b> <b>Légende symboles</b> <b>Leyenda símbolos</b>	pag. 345
<b>Istruzioni di montaggio</b> <b>Assembly instructions</b> <b>Instructions de montage</b> <b>Instrucciones de montaje</b>	pag. 348
<b>Condizioni generali di vendita</b> <b>General sales and delivery terms</b> <b>Conditions générales de vente</b> <b>Condiciones generales de venta</b>	pag. 350
<b>Indice progressivo</b> <b>Progressive index</b> <b>Index par ordre croissant</b> <b>Índice de códigos</b>	pag. 358

## ROUND

<b>MY ART</b>	pag. XVIII
<b>MY LOVE</b>	pag. 10
<b>CLAIRE_7100</b>	pag. 40
<b>GEALUNA_1000</b>	pag. 74
<b>ONE_2400</b>	pag. 130
<b>TOUCH_4600</b>	pag. 142
<b>MY MIRROR</b>	pag. 242
<b>COMFORT_H900</b>	pag. 252
<b>Maniglioni Grab-bars Barres d'appui Manillones</b>	pag. 260
<b>Cestini Basket Paniers porte-savon Jaboneras</b>	pag. 274
<b>Piantane Stands Accessoire sur pieds Toalleros de pie</b>	pag. 290
<b>Serie da appoggio Tabletop series Séries à poser Series de apoyo</b>	pag. 306

## SQUARE

<b>MY WAY</b>	pag. 16
<b>LEA_1800</b>	pag. 112
<b>MY MIRROR</b>	pag. 242
<b>Maniglioni Grab-bars Barres d'appui Manillones</b>	pag. 260
<b>Cestini Basket Paniers porte-savon Jaboneras</b>	pag. 274
<b>Piantane Stands Accessoire sur pieds Toalleros de pie</b>	pag. 290
<b>Serie da appoggio Tabletop series Séries à poser Series de apoyo</b>	pag. 306

**MINIMAL**

<b>MY SECRET_8000</b>	pag.	24
<b>INDISSIMA_8800</b>	pag.	48
<b>INDISSIMA CHROME_8800</b>	pag.	62
<b>MITO_2000</b>	pag.	88
<b>DIVO_1500</b>	pag.	102

**CLASSIC**

<b>RAFFAELLA_3200</b>	pag.	156
-----------------------	------	-----

**BASIC**

<b>MY LIKE</b>	pag.	20
<b>FORUM QUADRA_3000</b>	pag.	164
<b>FORUM_3600</b>	pag.	174
<b>COLORELLA_2300</b>	pag.	186
<b>HOTELLERIE</b>	pag.	200
<b>Sgabelli</b>	pag.	270
<b>Stools</b>		
<b>Tabourets</b>		
<b>Taburetes</b>		
<b>Complementi doccia</b>	pag.	298
<b>Complements</b>		
<b>Compléments</b>		
<b>Complementos</b>		

# HISTORY

## A new way for conceiving the bathroom.

Inda, Gruppo Industriale italiano del settore arredobagno, con i suoi 75 anni d'esperienza è, dal 1944, al servizio di chi desidera arredare il proprio ambiente bagno con stile e funzionalità. La capacità del Gruppo di cogliere le esigenze ed i gusti di un pubblico eterogeneo in continuo cambiamento e di anticipare le tendenze dell'abitare, gli ha permesso di consolidare la leadership nei mercati internazionali. Sono tre le divisioni di prodotto del Gruppo: mobili, pareti doccia ed accessori, le cui creazioni formano in realtà un pensiero unico, ideale per infinite soluzioni d'arredamento della sala da bagno. Creatività, originalità, distintiva eleganza sono elementi caratterizzanti che si esprimono nel design Inda attraverso tutte le sue forme, dal classico, al moderno alle soluzioni più all'avanguardia, che rispondono armoniosamente all'evoluzione dell'abitare. Un progetto globale che si declina in ogni situazione architettonica, grazie all'eccezionale versatilità e dedizione delle proprie risorse creative e produttive.

Since 1944, with over 75 years of experience, Inda - Italian producer of bathroom furniture, accessories and shower enclosures - has been helping its customer to stylish and ergonomically furnish their bathrooms. The Group's ability to capture the needs and tastes of a diverse, constantly-changing public and anticipate current trends has helped it consolidate its leading place in international markets. The Group has three product ranges: furniture, shower enclosures and accessories. Its creations shape a unifying design, ideal for endless bathroom-furnishing solutions. Inda's design arises from creativity, originality and distinctive elegance expressing on all styles from classic to modern, to the most avant-garde solutions, that respond harmoniously to the way living evolves. It is a global project that comes through in every architectural situation thanks to the exceptional versatility and dedication of its creative and productive resources.

Inda est un groupe industriel italien spécialisé dans l'aménagement des salles de bains avec 75 années d'expérience au service de tous ceux qui souhaitent meubler leur salle de bains avec style et fonctionnalité. La capacité du groupe à satisfaire les besoins et les goûts d'un public hétérogène en constante évolution et à anticiper les tendances de la décoration d'intérieur lui ont permis de consolider le leadership sur les marchés internationaux. Ce groupe est divisé en trois catégories de produits: meubles, parois de douches et accessoires. Ses créations uniques offrent des solutions de décoration pour salles de bains infinies. La créativité, l'originalité, l'élégance qui le distingue sont des caractéristiques qui se reflètent dans la conception d'Inda sous toutes les formes: du classique au moderne, aux solutions d'avant-garde qui s'adaptent harmonieusement à l'évolution des foyers. Un projet global qui se décline dans toutes les solutions architectoniques grâce à la versatilité exceptionnelle et au dévouement des propres ressources créatives et productives.

Inda, Grupo Industrial italiano del sector de los muebles de baño, con 75 años de experiencia está, desde 1944, al servicio de quien desea decorar su ambiente del baño con estilo y funcionalidad. La capacidad del Grupo de captar las exigencias y los gustos de un público heterogéneo en continuo cambio y de anticipar las tendencias del vivir, les ha permitido consolidar el liderazgo en los mercados internacionales. Hay tres divisiones de producto del Grupo: muebles, paredes de ducha y accesorios, cuya recreación forman en realidad un pensamiento único, ideal para infinitas soluciones de decoración del cuarto de baño. Creatividad, originalidad, distintiva elegancia son elementos caracterizadores que se expresan en el diseño Inda a través de todas sus formas, desde el clásico, al moderno con las soluciones más de vanguardia, que responden armoniosamente a la evolución del habitáculo. Un proyecto global que se declina en cada situación arquitectónica, gracias a la excepcional versatilidad y dedicación de los propios recursos creativos y productivos.





# TOTAL LIVING

## A bathroom with a coordinated aesthetics.

Il bagno, oggi più che mai, è diventato uno spazio imprescindibile del nostro ambiente domestico, passando da un luogo di servizio a una vera e propria esperienza totalizzante. Per questo motivo, Inda propone diverse soluzioni di abbinamento estetico riguardante diverse categorie di prodotto, per arredare il tuo bagno con un'estetica coordinata. Pareti doccia, mobili, accessori: tutto è perfettamente abbinato.

Today more than ever, bathrooms have become an essential space in our home environment, going from being somewhere to freshen up to a real all-encompassing experience. This is why Inda offers different matching aesthetic solutions for different product categories to furnish your bathroom with a coordinated look. Shower enclosures, furniture, accessories: everything fits perfectly together.

La salle de bains est désormais un espace indispensable dans nos foyers. C'est bien plus qu'une simple pièce de service, c'est une véritable expérience complète de notre quotidien. C'est pour cette raison qu'Inda propose diverses combinaisons d'ordre esthétique dans plusieurs catégories de produits pour meubler votre salle de bains de manière esthétique et coordonnée. Les parois de douche, le meubles et les accessoires sont parfaitement coordonnés.

El baño, hoy más que nunca, se ha convertido en un espacio imprescindible de nuestro ambiente doméstico, pasando de un lugar de servicio a una verdadera experiencia totalizante. Por este motivo, Inda propone diversas soluciones de combinación estética relacionadas con varias categorías de productos, para decorar tu baño con una estética coordinada. Paredes de ducha, muebles, accesorios: todo encaja perfectamente.



Come comporre il codice / How to create a code  
 Comment composer le code / Como componer los código

cod.	L	X	pz.	Prezzo unitario Unit price Prix unitaire Precios unitario	
				€	€
<b>A1818A ...</b>	<b>360</b>	<b>300</b>	<b>1</b>	68,60	79,70
<b>A1818B ...</b>	<b>510</b>	450	1	83,00	96,10
<b>A1818C ...</b>	<b>660</b>	600	1	92,90	107,20
<b>A1818D ...</b>	<b>860</b>	800	1	<b>117,70</b>	<b>129,30</b>

Interasse, le dimensioni sono in mm  
 Centre distance, sizes in mm  
 Entraxe, les dimensions sont indiquées en mm  
 Distancia entre soportes, las medidas son en mm

Larghezza, le dimensioni sono in mm  
 Width, sizes in mm  
 Largeur, les dimensions sont indiquées en mm  
 Ancho, las medidas son en mm

Finitura  
 Finish  
 Finition  
 Acabado

CR

NE  
 WM

Spedizione entro 1 settimana  
 Shipping within 1 week  
 Le délai départ usine est de 1 semaine  
 Expedición en 1 semana al máximo

Serie, modello e misura del prodotto  
 Series, model and size of the product  
 Série, modèle et dimensions du produit  
 Serie, modelo y medida del producto

Prezzo unitario  
 Unit price  
 Prix unitaire  
 Precios unitario

**A 18 18 D CR**















Accessori  
 Accessoires  
 Accesorios

Serie  
 Series  
 Série  
 Serie

Modello  
 Model  
 Modèle  
 Modelo

Finitura  
 Finish  
 Finition  
 Acabado

Misura del prodotto  
 Size of the product  
 Dimensions du produit  
 Medida del producto

		MY ART *	MY LOVE	MY WAY	MY LIKE	CLAIRE	INDISSIMA	INDISSIMA CHROME	GEALUNA	MITO	DIVO	LEA	ONE	TOUCH	RAFFAELLA	FORUM QUADRA	FORUM	COLORELLA	COMFORT
<b>CR</b> Cromato Chrome-plated Chromé Cromado		•	•	•		•		•	•	•	•	•	•	•	•	•	•	•	•
<b>AC</b> Nickel spazzolato Brushed nickel Nickel brossé Níquel cepillado			•			•				•		•	•						
<b>CG</b> Cromo nero spazzolato Brushed black chrome Black chrome brossé Cromado negro cepillado			•									•	•						
<b>OR</b> Oro rosato lucido Glossy rose-coloured gilded Doré rosé brillant Cromado rosado brillante			•									•	•						
<b>DR</b> Dorato 24 carati Gilded 24 carats Doré 24 carats Dorado 24 quilates			•									•	•		•				
<b>BZ</b> Bronzo Bronzed Bronze Bronce			•									•	•		•				
<b>AL</b> Acciaio inox AISI 304 Stainless steel AISI 304 Acier inoxydable AISI 304 Acero inoxidable AISI 304					•														
<b>NE</b> Nero opaco Matt black Noir mat Negro mate		•	•	•	•	•	•			•	•	•	•						
<b>WM</b> Bianco opaco Matt white Blanc mat Blanco mate		•	•	•			•			•		•	•						
<b>NS</b> Acciaio inox spazzolato AISI 304 Brushed stainless steel AISI 304 Acier inoxydable brossé AISI 304 Acero inoxidable cepillado AISI 304					•		•		•										
<b>AS</b> Acciaio inox satinato AISI 304 Satin stainless steel AISI 304 Acier inoxydable satiné AISI 304 Acero inoxidable satinado AISI 304			•	•															
<b>CU</b> Cromato/nero soft touch me-plated/black soft touch noir soft touch Cromado/negro soft touch																			•
<b>01 - 03</b> Vetro trasparente Transparent glass Verre transparent Vidrio transparente									•		•		•						•
<b>21 - 26</b> Vetro satinato Satinated glass Verre satiné Vidrio satinado						•	•	•		•	•	•		•	•	•	•	•	•
<b>04</b> Vetro Fumé Fumé glass Verre Fumé Vidrio Fumé						•													
<b>07</b> Ceramica bianca White ceramic Céramique blanche Cerámica blanca															•				



**CR** Cromato/Chrome-plated/Chromé/Cromado

**AC** Nickel spazzolato/Brushed nickel/Nickel brossé/Níquel cepillado

**WM** Bianco opaco/Matt white/Blanc mat/Blanco mate

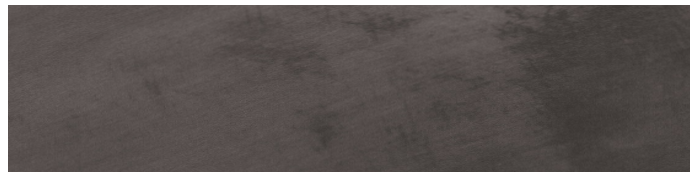
**NE** Nero opaco/Matt black/Noir mat/Negro mate

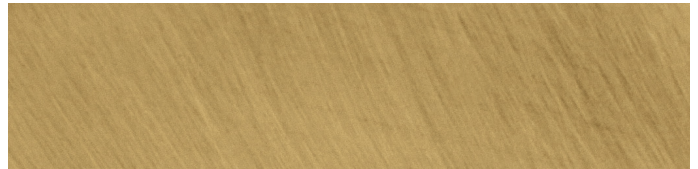
**OR** Oro rosato lucido/Glossy rose-coloured gilded  
Doré rosé brillant/Cromado rosado brillante

**CG** Cromo nero spazzolato/Brushed black chrome  
Black chrome brossé/Cromado negro cepillado

**DR** Dorato 24 carati/Gilded 24 carats/Doré 24 carats/Dorado 24 quilates

**BZ** Bronzo/Bronzed/Bronze/Bronce

**AL** Acciaio Inox AISI 304/Stainless steel AISI 304  
Acier inoxydable AISI 304/Acero inoxidable AISI 304

**AP** Alluminio lucido/Polished aluminium/Aluminium brillant/Alumínio brilhante

**NS** Acciaio inox spazzolato AISI 304/Brushed stainless steel AISI 304  
Acier inoxydable brossé AISI 304/Acero inoxidable cepillado AISI 304

**AS** Acciaio inox satinato AISI 304/Satin stainless steel AISI 304  
Acier inoxydable satiné AISI 304/Acero inoxidable satinado AISI 304



**WZ** Bianco lucido/Glossy white  
**WW** Blanc brillant/Blanco brillante



**SL** Silver/Silver/Silver/Plata



**NC** Nero opaco-cromato/Matt black-chrome-plated  
 Noir mat-chromé/Mat negro-cromado



**NW** Nero/Black/Noir/Negro

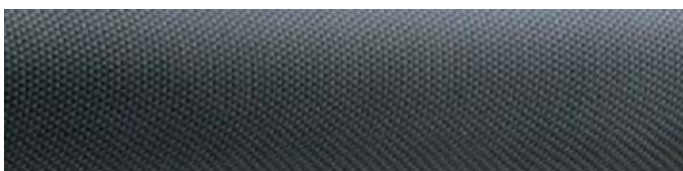

**CO** Carbonio

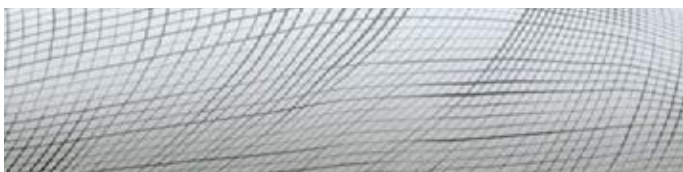

**GE** Geometric



**WY** Bianco opaco-cromato/Matt white-chrome-plated  
 Blanc mat-chromé/Blanco mate-cromado



**SN** Silver-nero/Silver-black/Silver-noir/Plata-negro



**CU** Cromato-nero soft touch/Chrome-plated-black soft touch  
 Chromé-noir soft touch/Chromado-negro soft touch



**RM** Rame



**ML** Militare

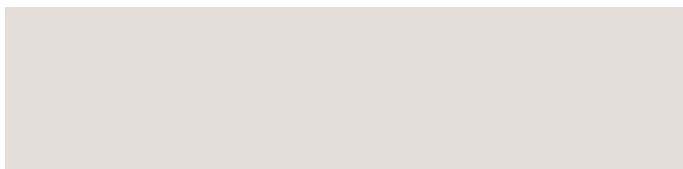
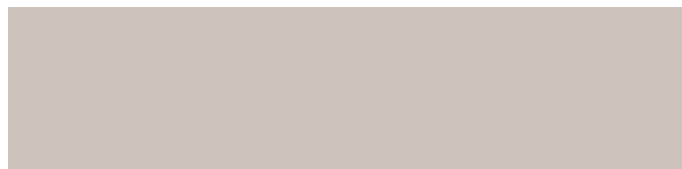
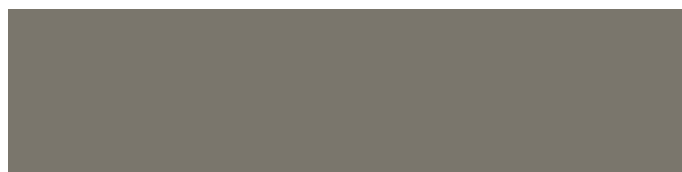

**CS** Classic

**BX** Bianco**MP** Perla**TL** Terra di Luna**BN** Bruno**GD** Giada**CE** Cemento**AX** Avorio**CX** Creta**NX** Nero**AQ** Acquamarina



**Finiture HPL mensole accessori / HPL finishes accessories shelves**  
**HPL finitions accessoires étagères / Acabado HPL estante accesorios**



Textil ice



Textil grey



Textil brown

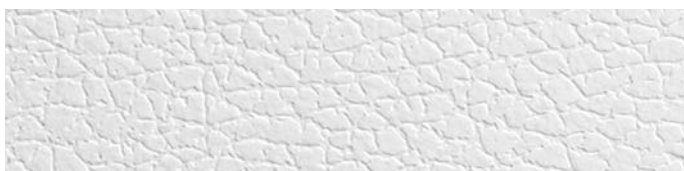

Fiore bianco



Calacatta



Porfido



Pietra scura



Yard



Larice panna



Larice sand



Larice brown

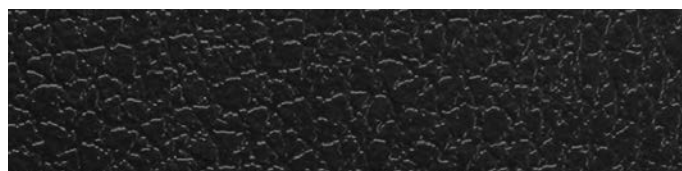

Fiore nero



Malta



Pietra chiara

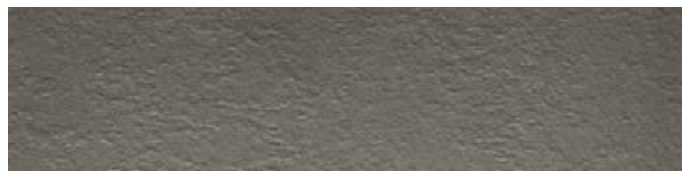

Cemento scuro

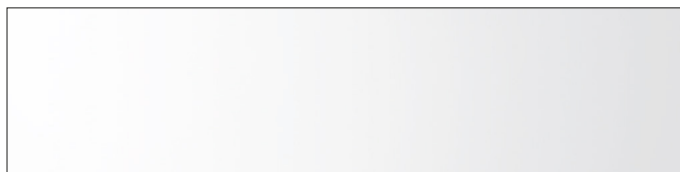
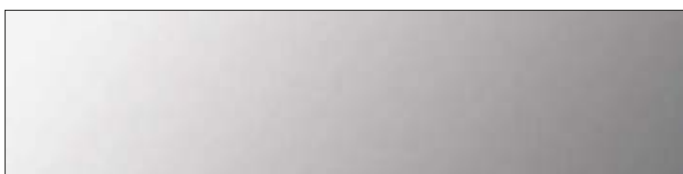
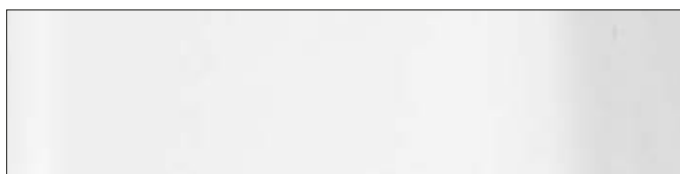

Lava

**01** Vetro trasparente/Transparent glass/Verre transparent/Vidrio transparente**03** Vetro extrachiaro trasparente/Extra clear transparent glass  
Verre transparent extra clair/Vidrio extraclaro transparente**02** Polimetilmetacrilato/Polymethyl methacrylate  
Polyméthacrylate de méthyle/Polimetilmetacrilado**21 - 26** Vetro satinato/Satined glass/Verre satiné/Vidrio satinado**04** Vetro Fumé/Fumé glass/Verre Fumé/Vidrio Fumé**07** Ceramica bianca/White ceramic/Céramique blanche/Ceramica blanca



# MY ART LOVE WAY LIKE

IT Il design universale si adatta ad ogni contesto. Corpo esterno, manico e coperchio in ottone cromato, base in plastica prolipilene per non danneggiare le superfici, imbuto di autocentraggio in plastica ABS con trattamento antibatterico. Fondello estraibile e scovolo di ricambio compreso in ogni confezione singola.

EN The universal design is suitable to any ambience. Outer part, handle and cover in chrome plated brass, basement in polypropylene plastic to avoid the surfaces' damaging, conical self-centering cover in ABS plastic with antibacterial treatment. Removable inner part and spare part brush inside every single pack.

FR La conception universelle s'adapte à tous les contextes. Corps extérieur, poignée et couvercle en laiton chromé, base en plastique prolipylène pour ne pas endommager les surfaces, entonnoir autocentrant en plastique ABS avec traitement antibactérien. Fond amovible et brosse de rechange inclus dans chaque pack.

ES El diseño universal se adapta a cualquier contexto. Cuerpo externo, mango y tapa en latón cromado, base en plástico polipropileno por evitar que se dañe la superficie, embudo de centrado en plástico ABS con tratamiento antibacteriano. Fondo extraíble y cepillo de recambio incluido en cada confección.



# MY ART LOVE WAY LIKE







# MY ART #collection 22





AV014BNE11Y



AV014AWM05Y



AV014ACR03Y

Originalità, ricercatezza del dettaglio e funzionalità fuse in un progetto nuovo e di tendenza come My Art, la nuova collezione scopini. My Art, my own style!

Originality, attention to details and functionality combined in the latest and updated project known as My Art, the new collection of toilet brush holders. My Art, my own style!

Originalité, raffinement des détails et fonctionnalité fusionnés dans un nouveau projet tendance tel que My Art, la nouvelle collection de balayette WC. My Art, my own style!

Originalidad, refinamiento de los detalles y funcionalidad se fusionan en un proyecto nuevo y de moda como es My Art, la nueva colección de escobillas de baño. ¡My Art, my own style!



AV014AWM07Y



AV014AWM09Y



AV014AWM08Y

# MY ART

New hygenical innovation 



Imbuto di autocentraggio in plastica ABS con trattamento antibatterico

Conical self-centering cover in ABS plastic with antibacterial treatment  
 Embout d'auto-centrage en plastique ABS antibactérien  
 Embudo de centrado en plástico ABS con tratamiento antibacteriano

Corpo esterno rivestito in carta vinilica resistente all'acqua  
 Outer part covered by water-resistant vinyl paper

Corps extérieur recouvert de papier vinyle résistant à l'eau  
 Cuerpo externo cubierto con papel vinílico resistente al agua

Base in plastica polipropilene: evita il danneggiamento delle superfici e garantisce una maggiore silenziosità durante l'appoggio

Basement in polypropylene pastic: avoid the damaging of surface areas and guarantees a quiet set down  
 Socle en plastique polypropylène: respect des surfaces et silence

Base en plástico polipropileno: evita se dañe la superficie y garantiza un mayor silencio durante el apoyo

Scovolo  
 Brush  
 Balayette  
 Cepillo

AV014BNE10Y

Fondello estraibile in plastica polipropilene con trattamento antibatterico: trattiene l'acqua di scolo dello scovolo e ne facilita la pulizia

Removable inner part in polypropylene plastic with antibacterial treatment: it collects water from the brush and simplifies cleaning

Coupelle intérieure amovible en plastique polypropylène antibactérien

Fondo extraible en plástico polipropileno con tratamiento antibacteriano: mantiene el agua del drenaje y facilita la limpieza





**CARTA DA PARATI**

Rivestimento in carta vinilica resistente all'acqua, lavabile, con texture effetto tessuto. Una soluzione unica ed esclusiva che segue costantemente le tendenze dell'arredobagno.

**WALL PAPER**

Coating made of water-resistant vinyl paper, washable, with a fabric effect. A one-of-a-kind solution that keeps following the bathroom decor trends.

**COUVERTURE EN PAPIER**

Couverture en papier vinyle résistant à l'eau et lavable avec une texture effet tissu. Une solution unique et exclusive qui suit constamment les tendances en matière d'ameublement de salle de bain.

**FUNDA DE PAPEL**

Funda de papel vinílico lavable y resistente al agua con textura efecto tela. Una solución única y exclusiva que sigue constantemente las tendencias en mobiliario de baño.



**Reazione al fuoco Classe B-e2,d0**  
Class B-s2, d0 of reaction to fire  
**Réaction au feu classe B-s2, d0**  
Reacción al fuego clase B-s2, d0



**Senza cloruro di vinile monomero, metalli pesanti, piombo, cadmio, plastificanti facilmente volatili e cfc**  
Without monomer vinyl chloride, heavy metals, lead, cadmium, easily volatile plasticisers and cfc  
**Sans chlorure de monomère de vinyle, métaux lourds, plomb, cadmium, plastifiants facilement volatils et cfc**  
Sin cloruro de vinilo monomero, metales pesados, plomo, cadmio, plásticos fácilmente volátiles y cfc

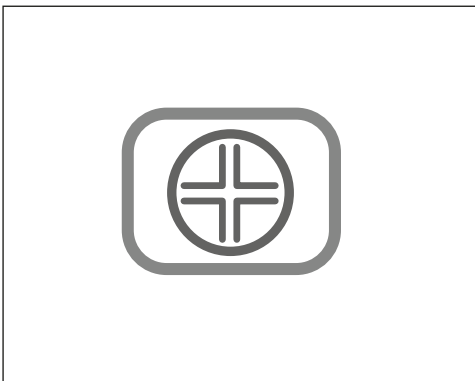

**A+ voc emission certified**

**TRATTAMENTO ANTIBATTERICO**

100% di igiene grazie al nuovo trattamento antibatterico delle parti in polipropilene. La sostanza igienizzante viene inserita direttamente nella materia prima garantendo l'eterna durata del trattamento.

**ANTIBACTERIAL TREATMENT**

100% hygienical thanks to the new antibacterial treatments of the polypropylene parts. The substance is placed directly into the basic material ensuring the eternal duration of treatment.

**TRAITEMENT ANTIBACTÉRIEN**

100% hygiénique grâce au traitement antibactérien des parties en polypropylène. La substance désinfectante est injectée directement dans la matière garantissant une durée éternelle du traitement.

**TRATAMIENTO ANTIBACTERIANO**

100% higiénico gracias al nuevo tratamiento antibacteriano de las partes en polipropileno. La sustancia higienizante se aplica directamente a la materia prima, garantizando la duración eterna del tratamiento.

**FUNZIONALITÀ**

Innovativo sistema autocentrante: la forma conica del coperchio facilita l'inserimento dello scovolo e assicura la corretta chiusura dello scopinolo.

**FUNCTIONALITY**

Innovative self-centering-system: the conical shape of the cover simplifies the insertion of the brush and ensures proper closing of the toilet brush.

**FONCTIONNEL**

Système d'auto-centrage innovant: la forme conique du couvercle facilite l'emboîtement de la balayette et assure ainsi une fermeture parfaite du porte-balai.

**FUNCIONALIDAD**

Innovativo sistema autocentrante: la forma cónica de la tapa facilita el inserción del cepillo y asegura el cierre correcto del escobillero.

**RICARICABILE**

Sostituisci lo scovolo senza toccare le parti non igieniche: impugna il coperchio e ruota il manico. La parte intercambiabile si sgancia automaticamente consentendone la sostituzione.

**RECHARGEABLE**

Replace the brush without touching any unsanitary part: holding the cover and turning the handle. The interchangeable part will be released automatically allowing the substitution.

**INTERCHANGEABLE**

Remplacez la balayette facilement: tenez le couvercle et faite tourner le manche.

**RECARGABLE**

Sustituye el cepillo sin tocar las partes no higiénicas: empuña la tapa y gira el mango. La parte intercambiabile se desengancha automáticamente consintiendo la sustitución.

## MY ART

## AURORA

NEW

Portascopino da appoggio.  
Free-standing toilet brush holder.  
Porte-balai à poser.  
Escobillero de suelo.

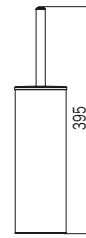

01Y

cod.	pz.	€
AV014ACR ...	1	154,00



## CUBIK

NEW

Portascopino da appoggio.  
Free-standing toilet brush holder.  
Porte-balai à poser.  
Escobillero de suelo.

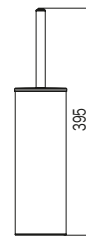

02Y

cod.	pz.	€
AV014ACR ...	1	154,00



## GAME OVER

NEW

Portascopino da appoggio.  
Free-standing toilet brush holder.  
Porte-balai à poser.  
Escobillero de suelo.

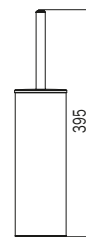
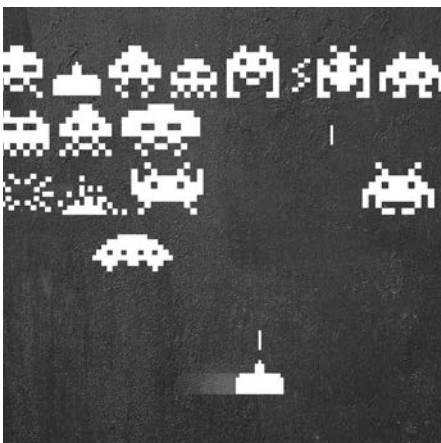

03Y

cod.	pz.	€
AV014ACR ...	1	154,00



**SKULL****NEW**

Portascopino da appoggio.  
Free-standing toilet brush holder.  
Porte-balai à poser.  
Escobillero de suelo.

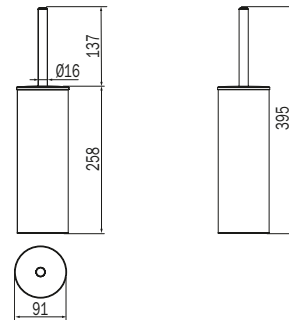

cod.	pz.	€
AV014BCR ...	1	154,00

04Y

**CARTOON****NEW**

Portascopino da appoggio.  
Free-standing toilet brush holder.  
Porte-balai à poser.  
Escobillero de suelo.

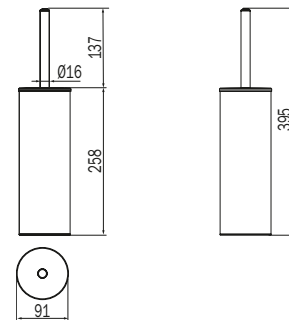

cod.	pz.	€
AV014AWM ...	1	154,00

05Y

**CALVARIAM****NEW**

Portascopino da appoggio.  
Free-standing toilet brush holder.  
Porte-balai à poser.  
Escobillero de suelo.

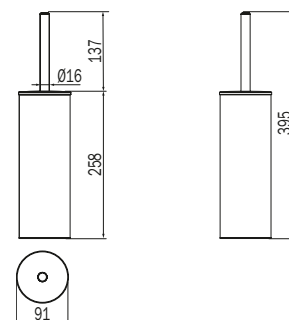

cod.	pz.	€
AV014AWM ...	1	154,00

06Y

## MY ART

## CUBA

NEW

Portascopino da appoggio.  
Free-standing toilet brush holder.  
Porte-balai à poser.  
Escobillero de suelo.

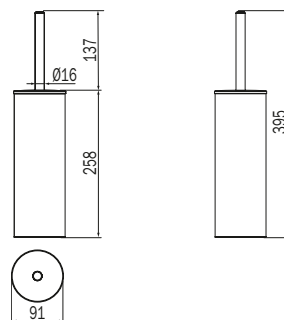

cod.	pz.	€
AV014AWM ...	1	154,00

07Y

## URSS

NEW

Portascopino da appoggio.  
Free-standing toilet brush holder.  
Porte-balai à poser.  
Escobillero de suelo.

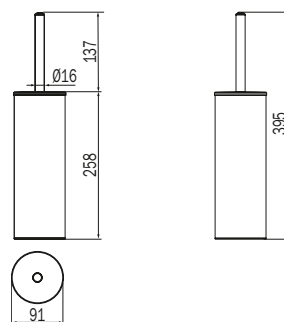

cod.	pz.	€
AV014AWM ...	1	154,00

08Y

## USA

NEW

Portascopino da appoggio.  
Free-standing toilet brush holder.  
Porte-balai à poser.  
Escobillero de suelo.

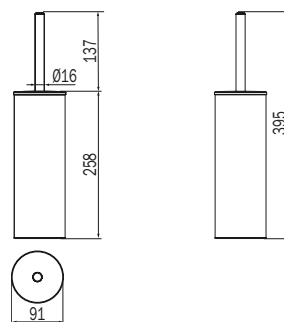

cod.	pz.	€
AV014AWM ...	1	154,00

09Y

**TYP0**

NEW

Portascopino da appoggio.  
Free-standing toilet brush holder.  
Porte-balai à poser.  
Escobillero de suelo.

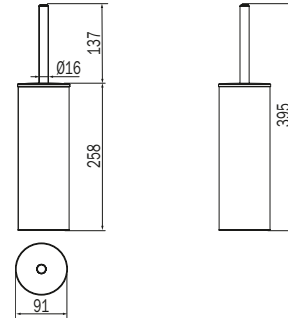

cod.	pz.	€
AV014BNE ...	1	154,00

10Y

**GRAFFITI**

NEW

Portascopino da appoggio.  
Free-standing toilet brush holder.  
Porte-balai à poser.  
Escobillero de suelo.

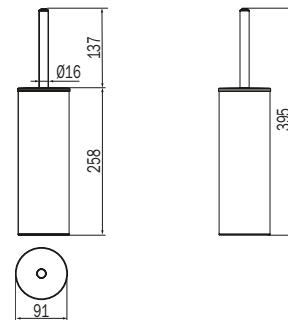

cod.	pz.	€
AV014BNE ...	1	154,00

11Y

**LA SANTA**

NEW

Portascopino da appoggio.  
Free-standing toilet brush holder.  
Porte-balai à poser.  
Escobillero de suelo.

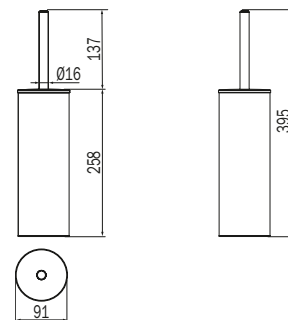

cod.	pz.	€
AV014BNE ...	1	154,00

12Y



# MY LOVE





**AV014BCR**



**AV014BAC**



**AV014BNE**



**AV014BNC**



**AV014BCG**



**AV014BCO**



**AV014ACS**



**AV014BML**



**AV014BRM**

# MY LOVE

New hygienical innovation 

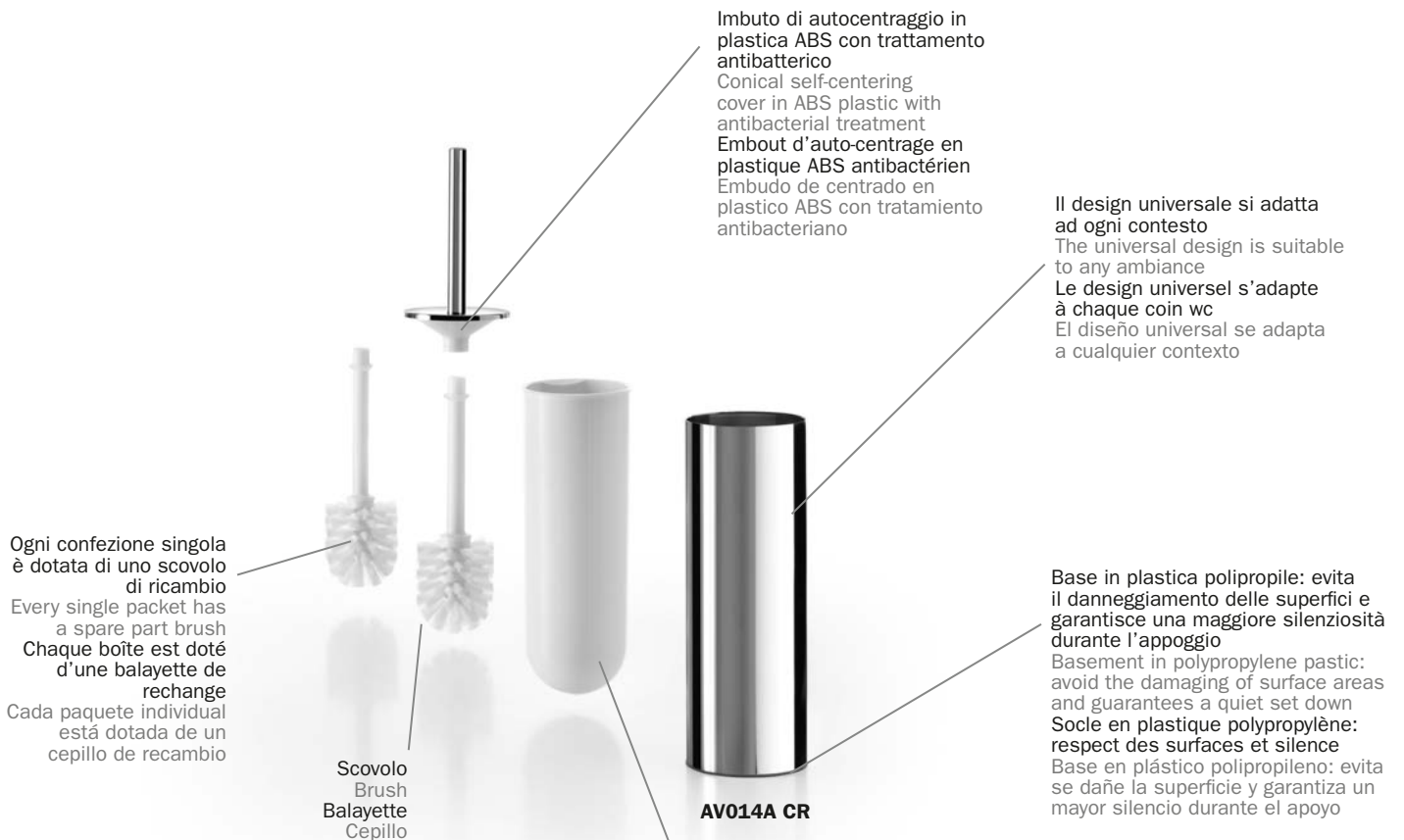

Ogni confezione singola è dotata di uno scovolo di ricambio  
Every single packet has a spare part brush  
Chaque boîte est dotée d'une balayette de rechange  
Cada paquete individual está dotada de un cepillo de recambio

Scovolo  
Brush  
Balayette  
Cepillo

Imbuto di autocentraggio in plastica ABS con trattamento antibatterico  
Conical self-centering cover in ABS plastic with antibacterial treatment  
Embout d'auto-centrage en plastique ABS antibactérien  
Embudo de centrado en plástico ABS con tratamiento antibacteriano

Il design universale si adatta ad ogni contesto  
The universal design is suitable to any ambience  
Le design universel s'adapte à chaque coin wc  
El diseño universal se adapta a cualquier contexto

Base in plastica polipropilene: evita il danneggiamento delle superfici e garantisce una maggiore silenziosità durante l'appoggio  
Basement in polypropylene pastic: avoid the damaging of surface areas and guarantees a quiet set down  
Socle en plastique polypropylène: respect des surfaces et silence  
Base en plástico polipropileno: evita se dañe la superficie y garantiza un mayor silencio durante el apoyo

AV014A CR

Fondello estraibile in plastica polipropilene con trattamento antibatterico: trattiene l'acqua di scolo dello scovolo e ne facilita la pulizia

Removable inner part in polypropylene plastic with antibacterial treatment: it collects water from the brush and simplifies cleaning

Coupelle intérieure amovible en plastique polypropylène antibactérien

Fondo extraíble en plástico polipropileno con tratamiento antibacteriano: mantiene el agua del drenaje y facilita la limpieza



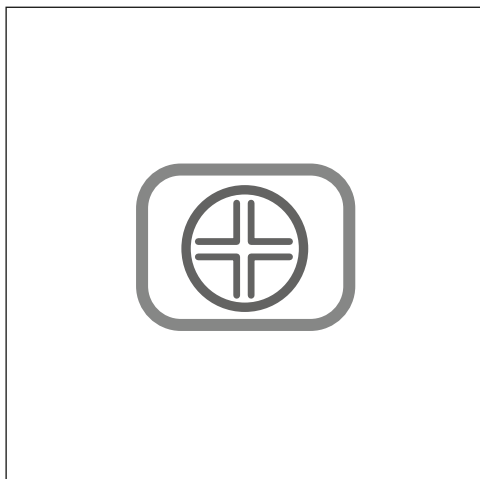

**TRATTAMENTO ANTIBATTERICO**

100% di igiene grazie al nuovo trattamento antibatterico delle parti in polipropilene. La sostanza igienizzante viene inserita direttamente nella materia prima garantendo l'eterna durata del trattamento.

**ANTIBACTERIAL TREATMENT**

100% hygienical thanks to the new antibacterial treatments of the polypropylene parts. The substance is placed directly into the basic material ensuring the eternal duration of treatment.

**TRAITEMENT ANTIBACTÉRIEN**

100% hygiénique grâce au traitement antibactérien des parties en polypropylène. La substance désinfectante est injectée directement dans la matière garantissant une durée éternelle du traitement.

**TRATAMIENTO ANTIBACTERIANO**

100% higiénico gracias al nuevo tratamiento antibacteriano de las partes en polipropileno. La sustancia higienizante se aplica directamente a la materia prima, garantizando la duración eterna del tratamiento.

**FUNZIONALITÀ**

Innovativo sistema autocentrante: la forma conica del coperchio facilita l'inserimento dello scovolo e assicura la corretta chiusura dello scovino.

**FUNCTIONALITY**

Innovative self-centering-system: the conical shape of the cover simplifies the insertion of the brush and ensures proper closing of the toilet brush.

**FONCTIONNEL**

Système d'auto-centrage innovant: la forme conique du couvercle facilite l'emboîtement de la balayette et assure ainsi une fermeture parfaite du porte-balai.

**FUNCIONALIDAD**

Innovativo sistema autocentrante: la forma cónica de la tapa facilita el inserción del cepillo y asegura el cierre correcto del escobillero.

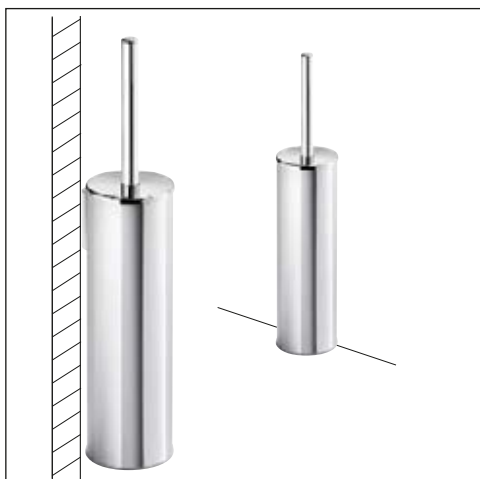
**VERSATILITÀ**

Lo stesso prodotto può essere utilizzato in appoggio o installato a parete poiché la placca per il fissaggio è sempre compresa nella confezione.

**VERSATILITY**

The same product is suitable for free-standing or wall mounted because the wall mounting plate is always included in the package.

**POLYVALENT**

Le même produit peut être aussi bien posé au sol que fixé au mur grâce à la pate de fixation incluse dans l'emballage.

**VERSATILIDAD**

El mismo producto puede ser utilizado de apoyo o instalado a la pared puesto que la placa de fijación viene incluida en la confección.

**RICARICABILE**

Sostituisci lo scovolo senza toccare le parti non igieniche: impugnare il coperchio e ruota il manico. La parte intercambiabile si sgancia automaticamente consentendone la sostituzione.

**RECHARGEABLE**

Replace the brush without touching any unsanitary part: holding the cover and turning the handle. The interchangeable part will be released automatically allowing the substitution.

**INTERCHANGEABLE**

Remplacez la balayette facilement: tenez le couvercle et faites tourner le manche.

**RECARGABLE**

Sustituye el cepillo sin tocar las partes no higiénicas: empuña la tapa y gira el mango. La parte intercambiable se desengancha automáticamente consintiendo la sustitución.



**AV014A**

Portascopino da parete/da appoggio. Scovolo di ricambio bianco incluso  
 Wall mounted/free-standing toilet brush holder. White spare brush included  
 Porte-balai mural/à poser. Balayette de rechange blanche incluse  
 Escobillero de pared/de suelo. Escobilla de repuesto blanca incluida

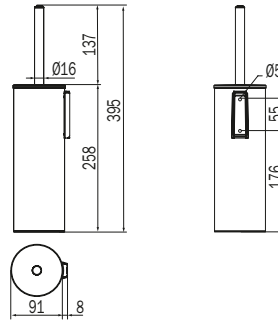

cod.	pz.	CR	AS	OR	DR	GE
		WM	WZ	BZ	CS	CS
AV014A ...	1	100,80	116,90	161,90	196,20	181,10

**AV014B**

Portascopino da parete/da appoggio. Scovolo di ricambio grigio incluso  
 Wall mounted/free-standing toilet brush holder. Grey spare brush included  
 Porte-balai mural/à poser. Balayette de rechange grise incluse  
 Escobillero de pared/de suelo. Escobilla de repuesto gris incluida

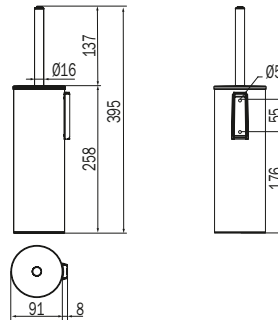

cod.	pz.	CR	CG	ML
		NE	AC	RM
AV014B ...	1	100,80	116,90	181,10



CR  
Cromato  
Chrome-plated  
Chromé  
Cromado



AC  
Nickel spazzolato  
Brushed nickel  
Nickel brossé  
Niquel cepillado



CG  
Cromo nero spazzolato  
Brushed black chrome  
Black chrome brossé  
Cromado negro cepillado



OR  
Oro rosato lucido  
Glossy rose-coloured gilded  
Doré rosé brillant  
Cromado rosado brillante



DR  
Dorato 24 carati  
Gilded 24 carats  
Doré 24 carats  
Dorado 24 quilates



BZ  
Bronzo  
Bronzed  
Bronze  
Bronce



NE  
Nero opaco  
Matt black  
Noir mat  
Negro mate



NC  
Nero opaco/cromato  
Matt black/chrome-plated  
Noir mat/chromé  
Negro mate/cromado



WM  
Bianco opaco  
Matt white  
Blanc mat  
Blanco mate



WZ  
Bianco lucido  
Glossy white  
Blanc brillant  
Blanco brillante



WY  
Bianco opaco/cromato  
Matt white/chrome-plated  
Blanc mat/chromé  
Blanco mate/cromado



AS  
Acciaio inox satinato AISI 304  
Satin stainless steel AISI 304  
Acier inoxydable satiné AISI 304  
Acero inoxidable satinado AISI 304



CO  
Carbonio



RM  
Rame



CS  
Classic



ML  
Militare



GE  
Geometric



# MY WAY





# MY WAY

New hygenical innovation 

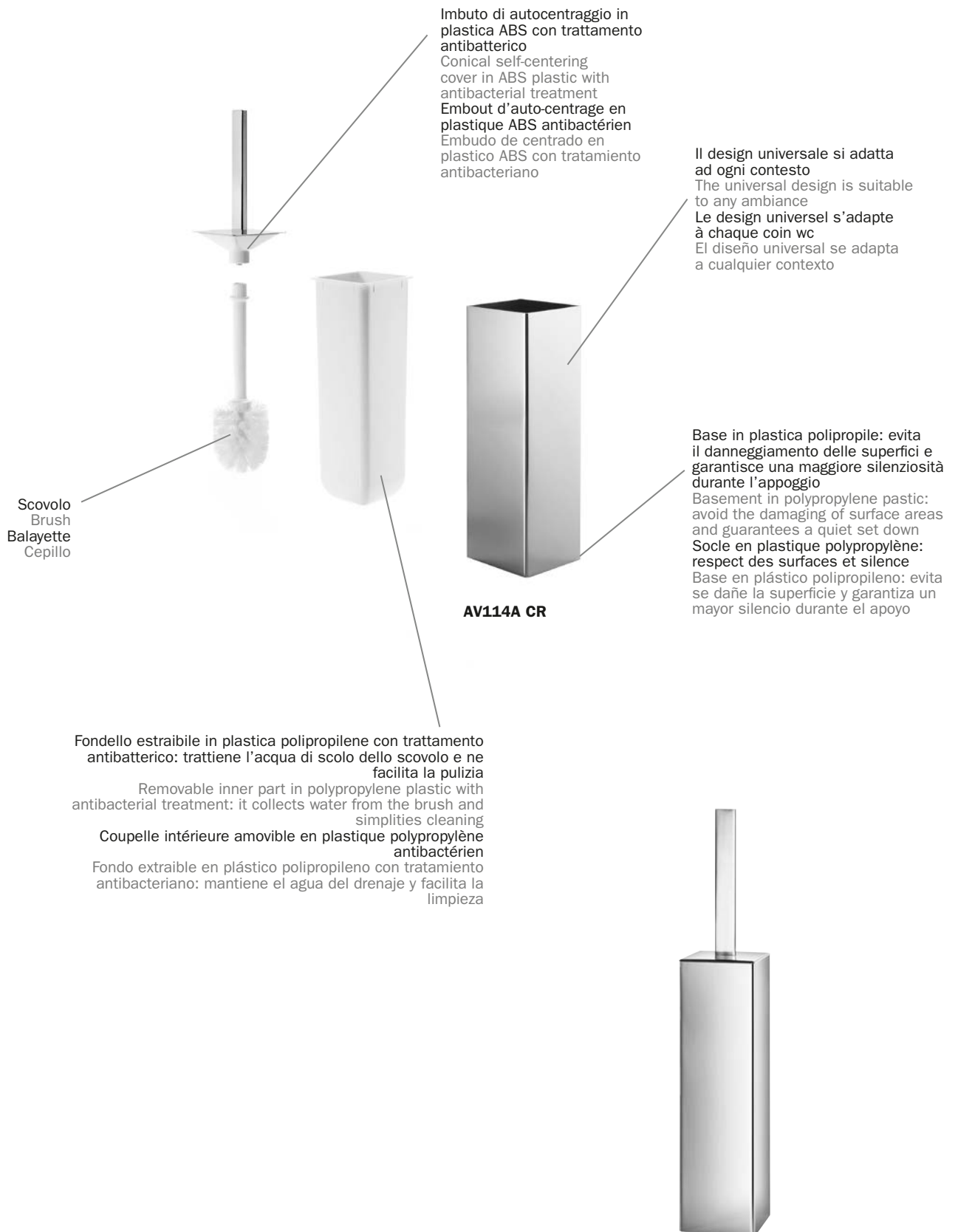

**Imbuto di autocentraggio in plastica ABS con trattamento antibatterico**

Conical self-centering cover in ABS plastic with antibacterial treatment

**Embout d'auto-centrage en plastique ABS antibactérien**  
Embudo de centrado en plástico ABS con tratamiento antibacteriano

**Il design universale si adatta ad ogni contesto**

The universal design is suitable to any ambience

**Le design universel s'adapte à chaque coin wc**

El diseño universal se adapta a cualquier contexto

**Scovolo**  
Brush  
Balayette  
Cepillo

**Base in plastica polipropilene: evita il danneggiamento delle superfici e garantisce una maggiore silenziosità durante l'appoggio**

Basement in polypropylene pastic: avoid the damaging of surface areas and guarantees a quiet set down

**Socle en plastique polypropylène: respect des surfaces et silence**

Base en plástico polipropileno: evita se dañe la superficie y garantiza un mayor silencio durante el apoyo

**AV114A CR**

**Fondello estraibile in plastica polipropilene con trattamento antibatterico: trattiene l'acqua di scolo dello scovolo e ne facilita la pulizia**

Removable inner part in polypropylene plastic with antibacterial treatment: it collects water from the brush and simplifies cleaning

**Coupelle intérieure amovible en plastique polypropylène antibactérien**

Fondo extraible en plástico polipropileno con tratamiento antibacteriano: mantiene el agua del drenaje y facilita la limpieza

**AV114A**

NEW

Portascopino da parete/da appoggio  
Wall mounted/free-standing toilet brush holder  
Porte-balai mural/à poser  
Escobillero de pared/de suelo

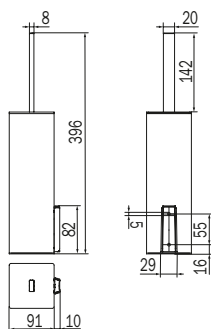

cod.	pz.	€		
		CR	AS	WM
AV114A ...	1	177,90	211,10	211,10

**AV114B**

NEW

Portascopino da parete/da appoggio  
Wall mounted/free-standing toilet brush holder  
Porte-balai mural/à poser  
Escobillero de pared/de suelo

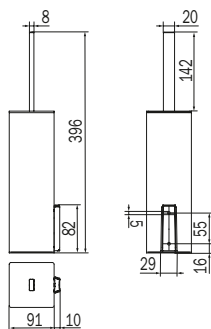

cod.	pz.	€	
		CR	NE
AV114B ...	1	177,90	211,10

CR

Cromato  
Chrome-plated  
Chromé  
Cromado

AS

Acciaio inox satinato AISI 304  
Satin stainless steel AISI 304  
Acier inoxydable satiné AISI 304  
Acero inoxidable satinado AISI 304

WM

Bianco opaco  
Matt white  
Blanc mat  
Blanco mate

NE

Nero opaco  
Matt black  
Noir mat  
Negro mate

# MY LIKE







# MY LIKE

New hygenical innovation

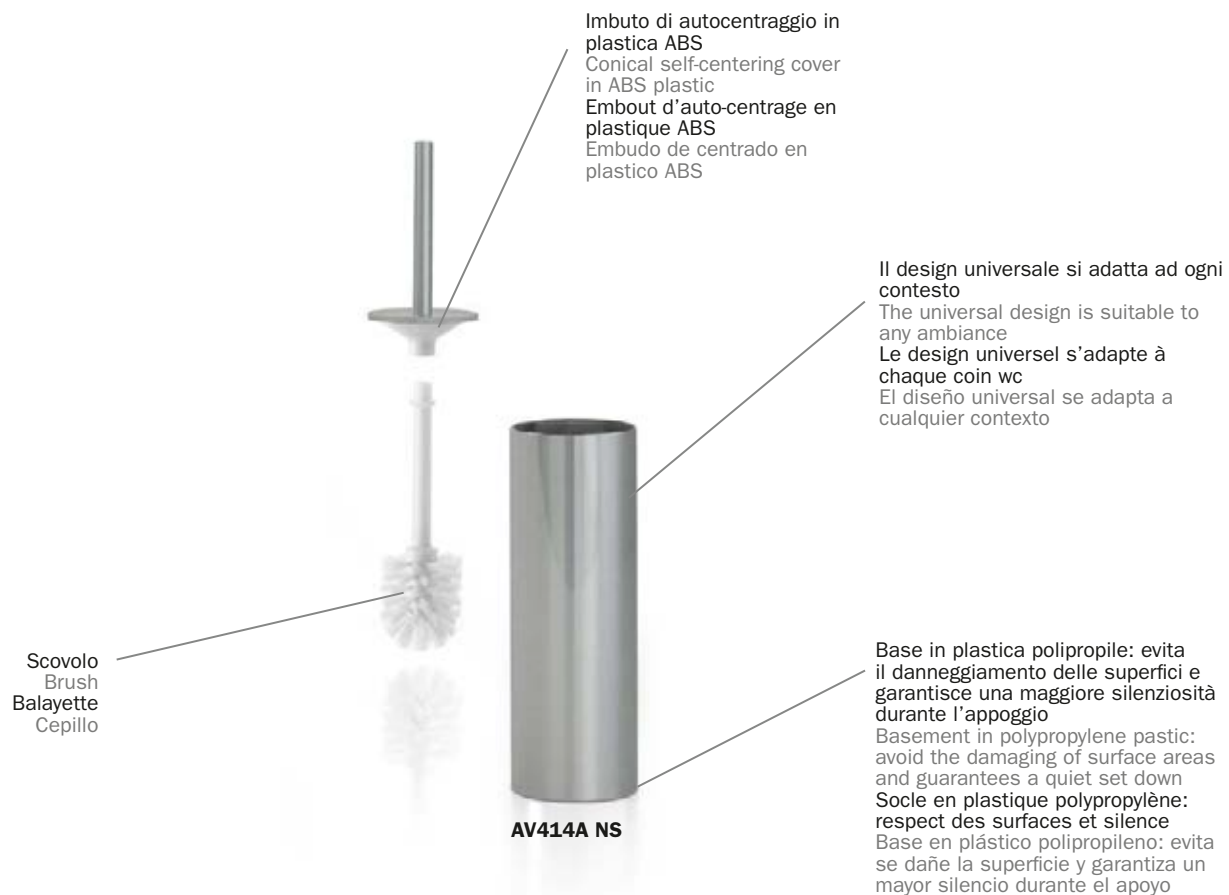

**AV414A**

NEW

Portascopino da parete/da appoggio  
Wall mounted/free-standing toilet brush holder  
Porte-balai mural/à poser  
Escobillero de pared/de suelo

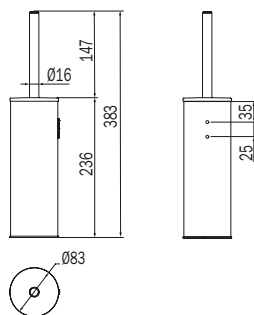

cod.	pz.	AL	NS
AV414A ...	1	81,40	87,30

**AV414B**

NEW

Portascopino da parete/da appoggio  
Wall mounted/free-standing toilet brush holder  
Porte-balai mural/à poser  
Escobillero de pared/de suelo

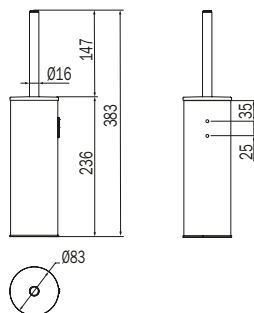

cod.	pz.	NE
AV414B ...	1	87,30



AL

Acciaio inox AISI 304  
Stainless steel AISI 304  
Acier inoxydable AISI 304  
Acero inoxidable AISI 304

NS

Acciaio inox spazzolato AISI 304  
Brushed stainless steel AISI 304  
Acier inoxydable brossé AISI 304  
Acero inoxidable cepillado AISI 304





NE

Nero opaco  
Matt black  
Noir mat  
Negro mate

# MY SECRET

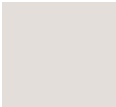
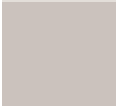
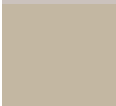
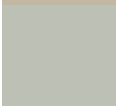
## MY SECRET\_8000

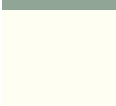
- IT** My secret: un nuovo concetto di spazio dove l'accessorio da bagno scompare! Un design versatile, un innovativo sistema di incasso a muro - totale o a semincasso o esterno - e una gamma di 10 colori, rendono My secret un componente trasversale che si adatta ad ogni tipo di soluzione, offrendo minimo ingombro e massima funzionalità.
- EN** My secret: a new concept of space where the accessory can be tucked away! A versatile design, an innovative wall cabinet system - that can be fully, semi or non-recessed - and a range of 10 colors, make My Secret a transversal element which can fit any bathroom solution, occupying minimum space for maximum practical appeal.
- FR** My secret : une nouvelle idée d'espace où l'accessoire disparaît! Un dessin versatile, un système d'encastrement mural - totale, semi-encaissé ou externe - et une gamme de 10 couleurs, transforment My Secret en composant transversale qui s'adapte à toutes solutions, en offrant un encombrement minimale et la plus totale fonctionnalité.
- ES** My secret: un nuevo concepto de espacio donde el accesorio de baño desaparece! Un diseño versátil, un innovador sistema de encastro total a pared total, semi-empotrado o externo, y una gama de 10 colores, hacen de My Secret un componente transversal que se adapta a cualquier tipo de solución, ofreciendo el mínimo espacio y la máxima funcionalidad.

	<b>MP</b> Laccato opaco Perla Matt lacquered Perla Laqué mat Perla Lacado mate Perla
	<b>AX</b> Laccato opaco Avorio Matt lacquered Avorio Laqué mat Avorio Lacado mate Avorio
	<b>TL</b> Laccato opaco Terra di Luna Matt lacquered Terra di Luna Laqué mat Terra di Luna Lacado mate Terra di Luna
	<b>CE</b> Laccato opaco Cemento Matt lacquered Cemento Laqué mat Cemento Lacado mate Cemento
	<b>CX</b> Laccato opaco Creta Matt lacquered Creta Laqué mat Creta Lacado mate Creta
	<b>BN</b> Laccato opaco Bruno Matt lacquered Bruno Laqué mat Bruno Lacado mate Bruno
	<b>AQ</b> Laccato opaco Acquamarina Matt lacquered Acquamarina Laqué mat Acquamarina Lacado mate Acquamarina
	<b>GD</b> Laccato opaco Giada Matt lacquered Giada Laqué mat Giada Lacado mate Giada
	<b>BX</b> Laccato opaco Bianco Matt lacquered Bianco Laqué mat Bianco Lacado mate Bianco
	<b>NX</b> Laccato opaco Nero Matt lacquered Nero Laqué mat Nero Lacado mate Nero





MY SECRET  
8000





MY SECRET  
8000



# Installazione\_muro grezzo / Installation\_gross wall Installation\_mur brut / Instalación\_pared sin baldosas

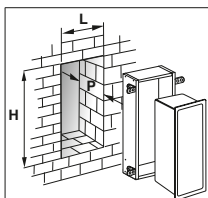

Moduli da incasso  
Recessed modul  
Module à encastrer  
Módulo encastrado

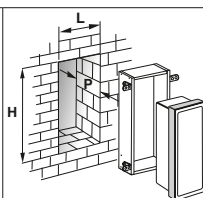

Moduli da semincasso  
Half built-in modul  
Module semi-encastré  
Módulo semiempotrado

## A807

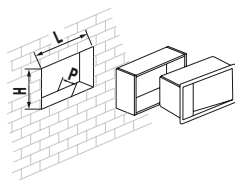

Moduli da incasso  
Recessed modul  
Module à encastrer  
Módulo encastrado

Moduli da semincasso  
Half built-in modul  
Module semi-encastré  
Módulo semiempotrado

cod.	L	H	P	cod.	L	H	P
<b>A80750+VT00304000</b>	371	277	160	<b>A80760+VT00308000</b>	371	277	90

## A808

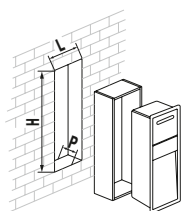

Moduli da incasso  
Recessed modul  
Module à encastrer  
Módulo encastrado

Moduli da semincasso  
Half built-in modul  
Module semi-encastré  
Módulo semiempotrado

cod.	L	H	P	cod.	L	H	P
<b>A8085A+VT00301000</b>	211	677	160	<b>A8086A+VT00305000</b>	211	677	90
<b>A8085B+VT00301000</b>	211	677	160				

## A808

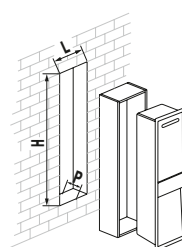

Moduli da incasso  
Recessed modul  
Module à encastrer  
Módulo encastrado

Moduli da semincasso  
Half built-in modul  
Module semi-encastré  
Módulo semiempotrado

cod.	L	H	P	cod.	L	H	P
<b>A8085C+VT00302000</b>	211	877	160	<b>A8086C+VT00306000</b>	211	877	90
<b>A8085D+VT00302000</b>	211	877	160				

## A803

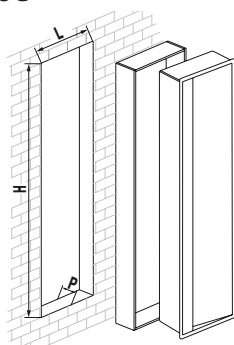

Moduli da incasso  
Recessed modul  
Module à encastrer  
Módulo encastrado

Moduli da semincasso  
Half built-in modul  
Module semi-encastré  
Módulo semiempotrado

cod.	L	H	P	cod.	L	H	P
<b>A8035A+VT00303000</b>	371	1617	160	<b>A8036A+VT00307000</b>	371	1617	90
<b>A8035B+VT00303000</b>	371	1617	160	<b>A8036B+VT00307000</b>	371	1617	90
<b>A8035C+VT00303000</b>	371	1617	160	<b>A8036C+VT00307000</b>	371	1617	90



# Installazione\_muro finito / Installation\_finished wall Installation\_mur fini / Instalación\_pared con baldosas

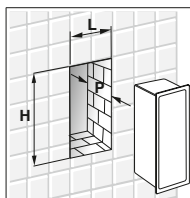

Moduli da incasso  
Recessed modul  
Module à encastrer  
Módulo encastrado

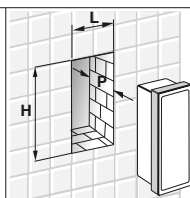

Moduli da semincasso  
Half built-in modul  
Module semi-encastré  
Módulo semiempotrado

## A807

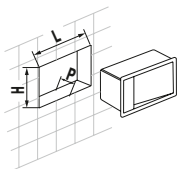

Moduli da incasso  
Recessed modul  
Module à encastrer  
Módulo encastrado

Moduli da semincasso  
Half built-in modul  
Module semi-encastré  
Módulo semiempotrado

cod.	L	H	P	cod.	L	H	P
<b>A80750</b>	335	240	160	<b>A80760</b>	335	240	90

## A808

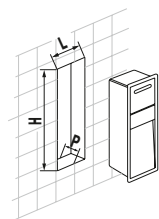

Moduli da incasso  
Recessed modul  
Module à encastrer  
Módulo encastrado

Moduli da semincasso  
Half built-in modul  
Module semi-encastré  
Módulo semiempotrado

cod.	L	H	P	cod.	L	H	P
<b>A8085A</b>	176	640	160	<b>A8086A</b>	176	640	90
<b>A8085B</b>	176	640	160	<b>A8086B</b>	176	640	90

## A808

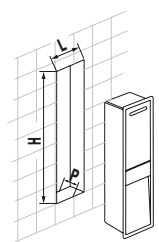

Moduli da incasso  
Recessed modul  
Module à encastrer  
Módulo encastrado

Moduli da semincasso  
Half built-in modul  
Module semi-encastré  
Módulo semiempotrado

cod.	L	H	P	cod.	L	H	P
<b>A8085C</b>	176	840	160	<b>A8086C</b>	176	840	90
<b>A8085D</b>	176	840	160	<b>A8086D</b>	176	840	90

## A803

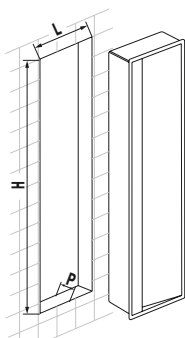

Moduli da incasso  
Recessed modul  
Module à encastrer  
Módulo encastrado

Moduli da semincasso  
Half built-in modul  
Module semi-encastré  
Módulo semiempotrado

cod.	L	H	P	cod.	L	H	P
<b>A8035A</b>	335	1580	160	<b>A8036A</b>	335	1580	90
<b>A8035B</b>	335	1580	160	<b>A8036B</b>	335	1580	90
<b>A8035C</b>	335	1580	160	<b>A8036C</b>	335	1580	90

## MY SECRET\_8000

### A80750

Modulo da incasso con portabicchiere e spandisapone  
 Recessed modul with tumbler holder and soap dispenser  
 Module à encastrer avec porte-verre, distributeur de savon liquide  
 Módulo encastrado con portavasos, dosificador de jabón

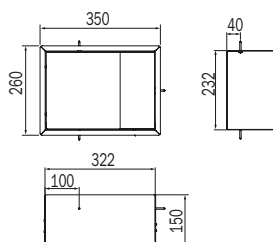

AQ AX BN BX CE CX GD MP NX TL

cod.	pz.	€
A80750 ...	1	482,10

### VT00304000

Controtelaio per art. A80750. Controtelaio obbligatorio per installazioni in nicchie di cartongesso  
 Subframe for art. A80750. Compulsory subframe for installation in drywall niches  
 Cadre d'installation pour art. A80750. Contre-châssis obligatoire pour l'installation en niche de plâtre  
 Contra estructura para art. A80750. Marco obligatorio para instalaciones en nichos de placas de cartón yeso

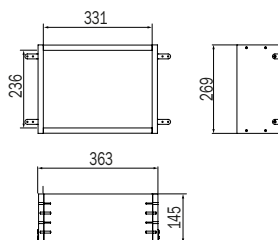
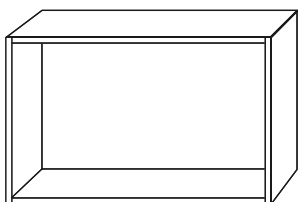

cod.	pz.	€
VT00304000	1	59,00

### A8085A

Modulo da incasso con portarotolo e portascopino My Love  
 Recessed modul with paper holder and My love toilet brush holder  
 Module à encastrer avec porte-rouleau, porte-balai My love  
 Módulo encastrado con portarollos, escobillero My love

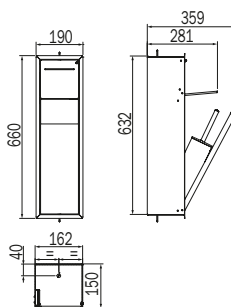

AQ AX BN BX CE CX GD MP NX TL

cod.	pz.	€
A8085A ...	1	557,10





Finitura BX My Love WM. Finitura NX My Love NE. Le altre finiture My Love CR  
 Finish BX My Love WM. Finish NX My Love NE. The other finishings My Love CR  
 Finition BX My Love WM. Finition NX My Love NE. Autres finitions My Love CR  
 Abacado BX My Love WM. Abacado NX My Love NE. Otros abacados My Love CR

**A8085B**

Modulo da incasso con portarotolo e idroscopino  
 Recessed modul with paper holder and hydrobrush  
 Module à encastrer avec porte-rouleau et douchette hygiénique WC  
 Módulo encastrado con portarollos y ducha higiénica

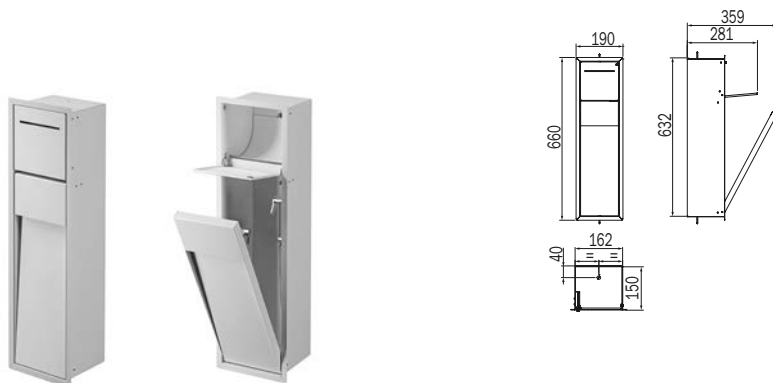

AQ  
AX  
BN  
BX  
CE  
CX  
GD  
MP  
NX  
TL

cod.	pz.	€
A8085B ...	1	589,20

**VT00301000**

Controtelaio per art. A8085A e A8085B. Controtelaio obbligatorio per installazioni in nicchie di cartongesso  
 Subframe for art. A8085A and A8085B. Compulsory subframe for installation in drywall niches  
 Cadre d'installation pour art. A8085A et A8085B. Contre-châssis obligatoire pour l'installation en niche de plâtre  
 Contra estructura para art. A8085A y A8085B. Marco obligatorio para instalaciones en nichos de placas de cartón yeso

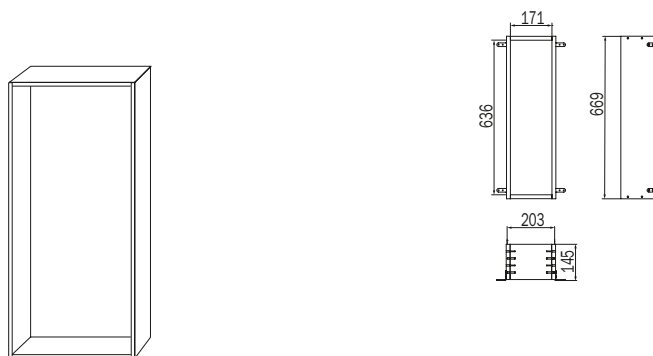

cod.	pz.	€
VT00301000	1	64,30

**A8085C**

Modulo da incasso con portarotolo, portarotolo di scorta e portascopino My Love  
 Recessed modul with paper holder, spare roll holder and My love toilet brush holder  
 Module à encastrer avec porte-rouleau, porte-rouleau réserve et porte-balai My love  
 Módulo encastrado con portarollos, portarollos de repuesto y escobillero My love

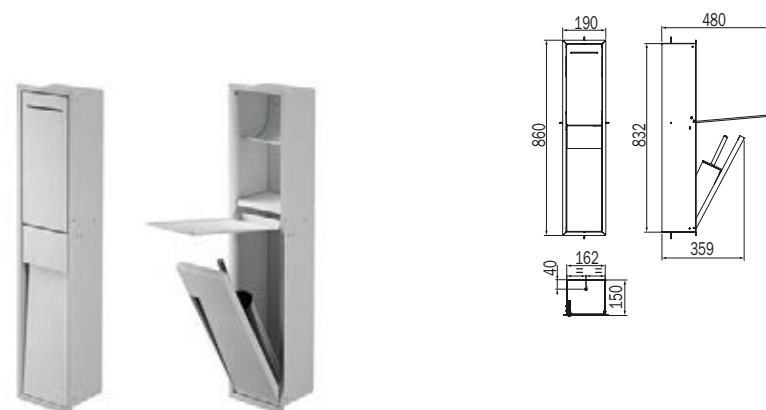

AQ  
AX  
BN  
BX  
CE  
CX  
GD  
MP  
NX  
TL

cod.	pz.	€
A8085C ...	1	632,10



## MY SECRET\_8000

### A8085D

Modulo da incasso con portarotolo, portarotolo di scorta e idroscopino  
 Recessed modul with paper holder, spare roll holder and hydrobrush  
 Module à encastrer avec porte-rouleau, porte-rouleau réserve et douchette hygiénique WC  
 Módulo encastrado con portarollos, portarollos de repuesto y ducha higiénica

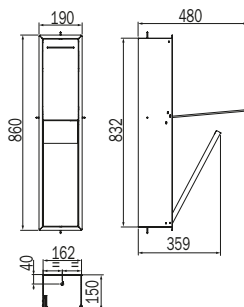

AQ  
AX  
BN  
BX  
CE  
CX  
GD  
MP  
NX  
TL

cod.	pz.	€
A8085D ...	1	664,20

### VT00302000

Controtelaio per art. A8085C e A8085D. Controtelaio obbligatorio per installazioni in nicchie di cartongesso  
 Subframe for art. A8085C and A8085D. Compulsory subframe for installation in drywall niches  
 Cadre d'installation pour art. A8085C et A8085D. Contre-châssis obligatoire pour l'installation en niche de plâtre  
 Contra estructura para art. A8085C y A8085D. Marco obligatorio para instalaciones en nichos de placas de cartón yeso

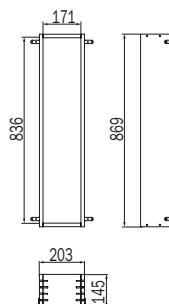
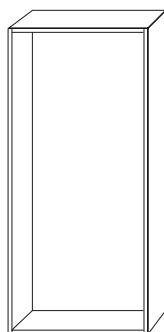

cod.	pz.	€
VT00302000	1	64,30

### A8035A

Modulo da incasso con mensole in vetro, anta battente con specchio interno  
 Recessed modul with glass shelves, pivot door with internal mirror  
 Module à encastrer avec tablettes en verre, porte battante avec miroir intérieur  
 Módulo encastrado con estantes de vidrio, puerta con espejo interior

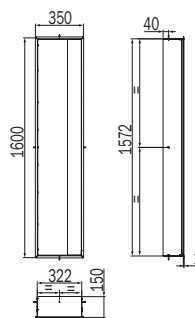

AQ  
AX  
BN  
BX  
CE  
CX  
GD  
MP  
NX  
TL

cod.	pz.	€
A8035A ...	1	878,40

 Finitura BX My Love WM. Finitura NX My Love NE. Le altre finiture My Love CR  
 Finish BX My Love WM. Finish NX My Love NE. The other finishings My Love CR  
 Finition BX My Love WM. Finition NX My Love NE. Autres finitions My Love CR  
 Abacado BX My Love WM. Abacado NX My Love NE. Otros abacados My Love CR

## A8035B

Modulo da incasso con mensole in vetro, portasciugacapelli, anta battente con specchio interno  
 Recessed modul with glass shelves, hairdryer holder, pivot door with internal mirror  
 Module à encastrer avec tablettes en verre, porte sèche-cheveux, porte battante avec miroir intérieur  
 Módulo encastrado con estantes de vidrio, secador de pelo, puerta con espejo interior

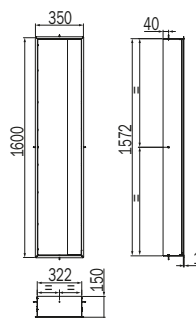

AQ AX BN BX CE CX GD MP NX TL

cod.	pz.	€
A8035B ...	1	996,30



MY SECRET  
8000

## A8035C

Modulo da incasso con mensole in vetro  
 Recessed modul with glass shelves  
 Module à encastrer avec tablettes en verre  
 Módulo encastrado con estantes de vidrio

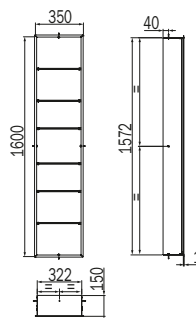

AQ AX BN BX CE CX GD MP NX TL

cod.	pz.	€
A8035C ...	1	589,20

## VT00303000

Controtelaio per art. A8035A, A8035B e A8035C. Controtelaio obbligatorio per installazioni in nicchie di cartongesso  
 Subframe for art. A8035A, A8035B and A8035C. Compulsory subframe for installation in drywall niches  
 Cadre d'installation pour art. A8035A, A8035B et A8035C. Contre-châssis obligatoire pour l'installation en niche de plâtre  
 Contra estructura para art. A8035A, A8035B y A8035C. Marco obligatorio para instalaciones en nichos de placas de cartón yeso

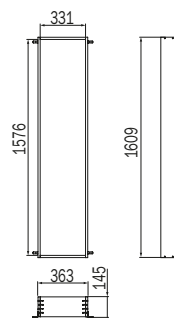
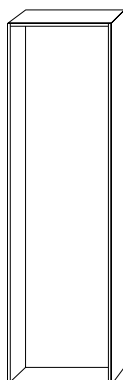

cod.	pz.	€
VT00303000	1	80,40

## MY SECRET\_8000

### A80760

Modulo da semincasso con portabicchiere e spandisapone  
 Half built-in modul with tumbler holder and soap dispenser  
 Module semi-encastré avec porte-verre et distributeur de savon liquide  
 Módulo semiempotrado con portavasos y dosificador de jabón

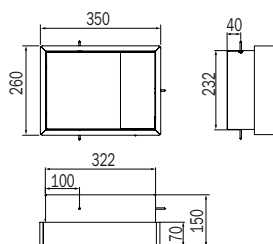

AQ AX BN BX CE CX GD MP NX TL

cod.	pz.	€
A80760 ...	1	602,10

### VT00308000

Controtelaio per art. A80760. Controtelaio obbligatorio per installazioni in nicchie di cartongesso  
 Subframe for art. A80760. Compulsory subframe for installation in drywall niches  
 Cadre d'installation pour art. A80760. Contre-châssis obligatoire pour l'installation en niche de plâtre  
 Contra estructura para art. A80760. Marco obligatorio para instalaciones en nichos de placas de cartón yeso

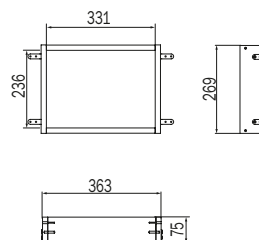
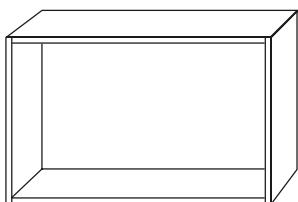

cod.	pz.	€
VT00308000	1	53,60

### A8086A

Modulo da semincasso con portarotolo e portascopino My love  
 Half built-in modul with paper holder and My love toilet brush holder  
 Module semi-encastré avec porte-rouleau et porte-balai My love  
 Módulo semiempotrado con portarollos y escobillero My love

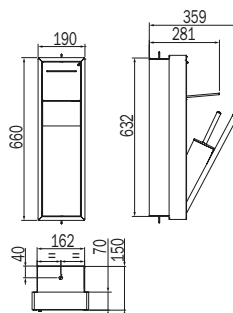

AQ AX BN BX CE CX GD MP NX TL

cod.	pz.	€
A8086A ...	1	696,30





Finitura BX My Love WM. Finitura NX My Love NE. Le altre finiture My Love CR  
 Finish BX My Love WM. Finish NX My Love NE. The other finishings My Love CR  
 Finition BX My Love WM. Finition NX My Love NE. Autres finitions My Love CR  
 Abacado BX My Love WM. Abacado NX My Love NE. Otros abacados My Love CR

**VT00305000**

Controtelaio per art. A8086A. Controtelaio obbligatorio per installazioni in nicchie di cartongesso  
 Subframe for art. A8086A. Compulsory subframe for installation in drywall niches  
 Cadre d'installation pour art. A8086A. Contre-châssis obligatoire pour l'installation en niche de plâtre  
 Contra estructura para art. A8086A. Marco obligatorio para instalaciones en nichos de placas de cartón yeso

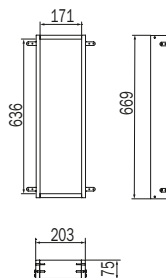
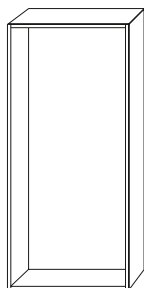

cod.	pz.	€
<b>VT00305000</b>	1	59,00

**A8086C**

Modulo da semincasso con portarotolo, portarotolo di scorta e portascopino My love  
 Half built-in modul with paper holder, spare roll holder and My love toilet brush holder  
 Module semi-encasté avec porte-rouleau, porte-rouleau réserve et porte-balai My love  
 Módulo semiempotrado con portarollos, portarollos de repuesto y escobillero My love

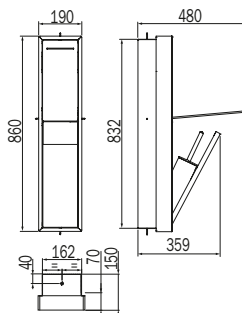

AQ  
AX  
BN  
BX  
CE  
CX  
GD  
MP  
NX  
TL

cod.	pz.	€
<b>A8086C ...</b>	1	789,50

**VT00306000**

Controtelaio per art. A8086C. Controtelaio obbligatorio per installazioni in nicchie di cartongesso  
 Subframe for art. A8086C. Compulsory subframe for installation in drywall niches  
 Cadre d'installation pour art. A8086C. Contre-châssis obligatoire pour l'installation en niche de plâtre  
 Contra estructura para art. A8086C. Marco obligatorio para instalaciones en nichos de placas de cartón yeso

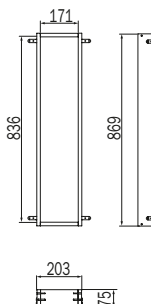
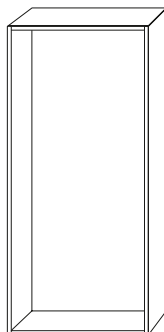

cod.	pz.	€
<b>VT00306000</b>	1	59,00

## MY SECRET\_8000

## A8036A

Modulo da semincasso con mensole in vetro, anta battente con specchio interno

Half built-in modul with glass shelves, pivot door with internal mirror

Module semi-encasté avec tablettes en verre, porte battante avec miroir intérieur

Módulo semiempotrado con estantes de vidrio, puerta con espejo interior

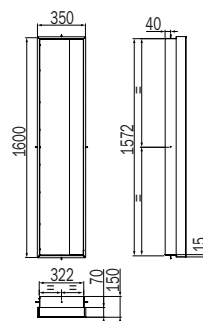

AQ  
AX  
BN  
BX  
CE  
CX  
GD  
MP  
NX  
TL

cod.	pz.	€
A8036A ...	1	1.098,00



## A8036B

Modulo da semincasso con mensole in vetro, portasciugacapelli, anta battente con specchio interno

Half built-in modul with glass shelves, hairdryer holder, pivot door with internal mirror

Module semi-encasté avec tablettes en verre, porte sèche-cheveux, porte battante avec miroir intérieur

Módulo semiempotrado con estantes de vidrio, secador de pelo, puerta con espejo interior

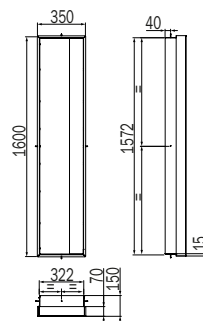

AQ  
AX  
BN  
BX  
CE  
CX  
GD  
MP  
NX  
TL

cod.	pz.	€
A8036B ...	1	1.244,80



## A8036C

Modulo da semincasso con mensole in vetro

Half built-in modul with glass shelves

Module semi-encasté avec tablettes en verre

Módulo semiempotrado con estantes de vidrio

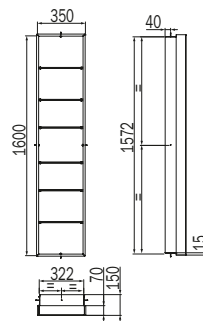

AQ  
AX  
BN  
BX  
CE  
CX  
GD  
MP  
NX  
TL

cod.	pz.	€
A8036C ...	1	736,00





Finitura BX My Love WM. Finitura NX My Love NE. Le altre finiture My Love CR  
 Finish BX My Love WM. Finish NX My Love NE. The other finishings My Love CR  
 Finition BX My Love WM. Finition NX My Love NE. Autres finitions My Love CR  
 Abacado BX My Love WM. Abacado NX My Love NE. Otros abacados My Love CR

**VT00307000**

Controtelaio per art. A8036A, A8036B e A8036C. Controtelaio obbligatorio per installazioni in nicchie di cartongesso  
 Subframe for art. A8036A, A8036B and A8036C. Compulsory subframe for installation in drywall niches  
 Cadre d'installation pour art. A8036A, A8036B et A8036C. Contre-châssis obligatoire pour l'installation en niche de plâtre  
 Contra estructura para art. A8036A, A8036B y A8036C. Marco obligatorio para instalaciones en nichos de placas de cartón yeso

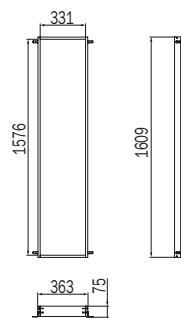
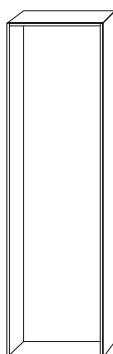

cod.	pz.	€
<b>VT00307000</b>	1	75,00

**A8037A**

Modulo esterno con mensole in vetro, anta battente con specchio interno  
 External modul with glass shelves, pivot door with internal mirror  
 Module externe avec tablettes en verre, porte battante avec miroir intérieur  
 Módulo externo con estantes de vidrio, puerta con espejo interior

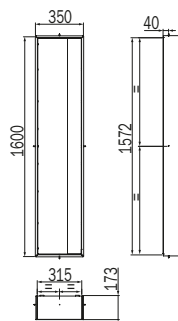

AQ  
AX  
BN  
BX  
CE  
CX  
GD  
MP  
NX  
TL

cod.	pz.	€
<b>A8037A ...</b>	1	1.156,90

**A8037B**

Modulo esterno con mensole in vetro, portasciugacapelli, anta battente con specchio interno  
 External modul with glass shelves, hairdryer holder, pivot door with internal mirror  
 Module externe avec tablettes en verre, porte sèche-cheveux, porte battante avec miroir intérieur  
 Módulo externo con estantes de vidrio, secador de pelo, puerta con espejo interior

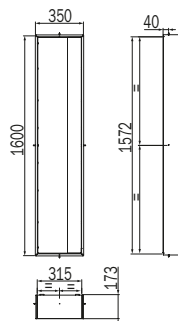

AQ  
AX  
BN  
BX  
CE  
CX  
GD  
MP  
NX  
TL

cod.	pz.	€
<b>A8037B ...</b>	1	1.312,30



# MY SECRET\_8000

## A8037C

Modulo esterno con mensole in vetro  
 External modul with glass shelves  
 Module externe avec tablettes en verre  
 Módulo externo con estantes de vidrio

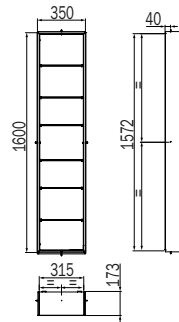

AQ  
AX  
BN  
BX  
CE  
CX  
GD  
MP  
NX  
TL

cod.	pz.	€
A8037C ...	1	773,50

## A8038A

Modulo esterno con mensole in vetro, anta battente con specchio interno  
 External modul with glass shelves, pivot door with internal mirror  
 Module externe avec tablettes en verre, porte battante avec miroir intérieur  
 Módulo externo con estantes de vidrio, puerta con espejo interior

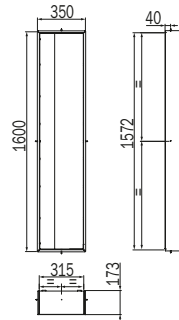

AQ  
AX  
BN  
BX  
CE  
CX  
GD  
MP  
NX  
TL

cod.	pz.	€
A8038A ...	1	1.156,90



## A8038B

Modulo esterno con mensole in vetro, portasciugacapelli, anta battente con specchio interno  
 External modul with glass shelves, hairdryer holder, pivot door with internal mirror  
 Module externe avec tablettes en verre, porte sèche-cheveux, porte battante avec miroir intérieur  
 Módulo externo con estantes de vidrio, secador de pelo, puerta con espejo interior

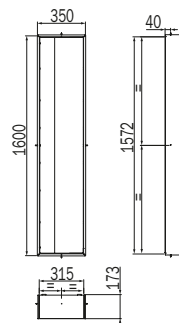

AQ  
AX  
BN  
BX  
CE  
CX  
GD  
MP  
NX  
TL

cod.	pz.	€
A8038B ...	1	1.312,30





MY SECRET  
8000

## CLAIRE\_7100

IT Forme sinuose e moderne coniugano solidità ed eleganza in un'estetica originale. Le finiture e gli elementi più innovativi si uniscono a quelli più tradizionali per offrire una serie completa dal carattere europeo.

EN Windy and modern shapes combine solidity and elegance in a unique aesthetics. The most innovative finishes and elements integrate the more traditional ones to present a complete series with a European character.

FR Les formes sinueuses et modernes allient solidité et élégance dans une esthétique originale. Les finitions et les éléments les plus innovants se combinent avec les plus traditionnels pour offrir une série complète au caractère européen.

ES Las formas sinuosas y modernas combinan solidez y elegancia en una estética original. Los acabados y elementos más innovadores se combinan con los más tradicionales para ofrecer una serie completa con carácter europeo.

	<b>CR</b> Cromato Chrome-plated Chromé Cromado
	<b>AC</b> Nickel spazzolato Brushed nickel Nickel brossé Níquel cepillado
	<b>NE</b> Nero opaco Matt black Noir mat Negro mate

# COMING SOON



Per tutti gli aggiornamenti sulla Serie, consultare il codice QR.

For all updates on the series, check out the QR code.

Pour toutes les mises à jour sur la série, consultez le code QR.

Para conocer todas las actualizaciones de la serie, consulte el código QR.



# CLAIRE

design Daniel Debiasi & Federico Sandri



CLATRE  
7100

## CLAIRE\_7100

**A7118**

NEW

Portasalviette  
Towel holder  
Porte-serviettes  
Toallero

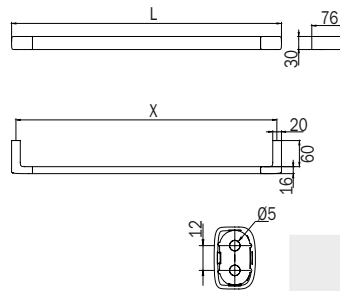

				CR	NE	AC
<b>cod.</b>	<b>L</b>	<b>X</b>	<b>pz.</b>			€
<b>A7118A ...</b>	<b>32</b>	<b>30</b>	<b>1</b>			-
<b>A7118B ...</b>	<b>47</b>	<b>45</b>	<b>1</b>			-
<b>A7118C ...</b>	<b>62</b>	<b>60</b>	<b>1</b>			-
<b>A7118D ...</b>	<b>82</b>	<b>80</b>	<b>1</b>			-

**A71150**

NEW

Portasalviette fisso a bandiera  
Fixed towel holder  
Porte-serviettes fixe à drapeau  
Toallero fijo a bandera

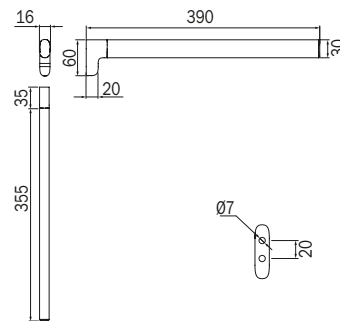

			CR	NE	AC
<b>cod.</b>		<b>pz.</b>			€
<b>A71150 ...</b>		<b>1</b>			-

**A7115A**

NEW

Portasalviette doppio fisso a bandiera  
Flag fixed double towel holder  
Porte-serviettes double fixe  
Portarrollos doble fijo a bandera

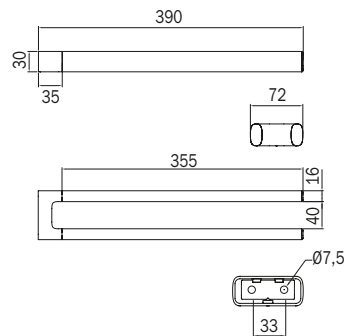

			CR	NE	AC
<b>cod.</b>		<b>pz.</b>			€
<b>A7115A ...</b>		<b>1</b>			-

**A71180**

NEW

Portasalviette doppio  
Double towel holder  
Porte-serviettes double  
Toallero doble

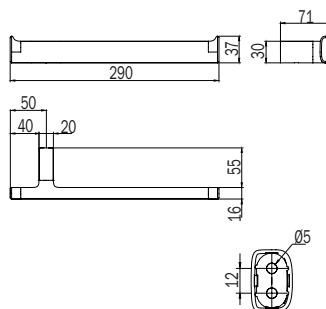

		CR	NE	AC
<b>cod.</b>	<b>pz.</b>			€
<b>A71180 ...</b>	1			-

**A7120A**

NEW

Appendiabiti  
Clothes hanger  
Patère  
Percha

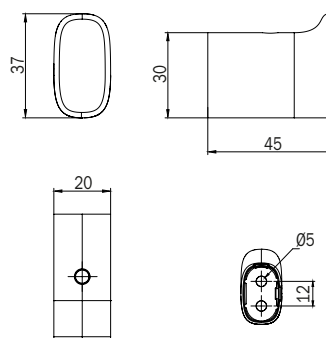

		CR	NE	AC
<b>cod.</b>	<b>pz.</b>			€
<b>A7120A ...</b>	1			-

**A7120B**

NEW

Appendiabiti doppio  
Double clothes hanger  
Patère double  
Percha doble

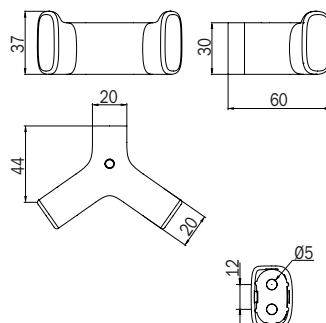

		CR	NE	AC
<b>cod.</b>	<b>pz.</b>			€
<b>A7120B ...</b>	1			-

## CLAIRE\_7100

## A7178A

NEW

Portabicchiere con portasapone/portaoggetti a parete destro/sinistro  
 Wall-mounted tumbler holder with right/left soap holder/objects holder  
 Porte-verre mural avec porte-savon/porte objets droit / gauche  
 Porta vaso a pared con jabonera porta objetos derecho/izquierdo

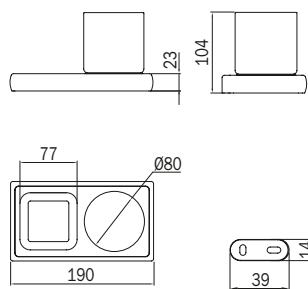

cod.	pz.	CR 04		NE 04		AC 04	
		CR 21	CR 21	NE 21	NE 21	AC 21	AC 21
A7178A ...	1	-	-	-	-	-	-
A7178B ...	1	-	-	-	-	-	-

## A7178C

NEW

Spandisapone a leva con portaoggetti a parete destro/sinistro. Leva in finitura  
 Wall-mounted lever soap dispenser with right/left objects holder. Lever in finish  
 Distributeur de savon mural à levier avec porte objets droite/gauche. Levier en finition  
 Dosificador a palanca p/pared, c/porta objetos der/izq. Palanca en acabado

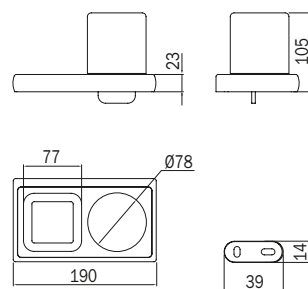

cod.	pz.	CR 04		NE 04		AC 04	
		CR 21	CR 21	NE 21	NE 21	AC 21	AC 21
A7178C ...	1	-	-	-	-	-	-
A7178D ...	1	-	-	-	-	-	-

## A7110F

NEW

Portabicchiere a parete con due bicchieri  
 Wall-mounted tumbler holder with two tumblers  
 Porte-verre mural avec deux verres  
 Portavasos a pared con dos vasos

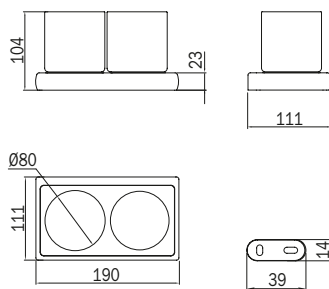

cod.	pz.	CR 04		NE 04		AC 04	
		CR 21	CR 21	NE 21	NE 21	AC 21	AC 21
A7110F ...	1	-	-	-	-	-	-



**A7110D**

NEW

Portabicchiere con spandisapone a leva a parete. Leva in finitura  
 Wall-mounted tumbler holder with lever soap dispenser. Lever in finish  
 Porte-verre avec distributeur de savon à levier mural. Levier en finition  
 Porta vaso con dosificador a palanca. Palanca en acabado

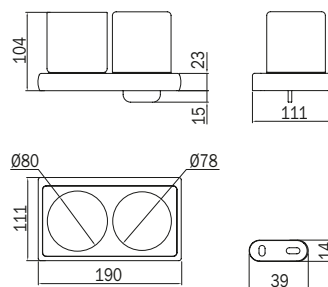

		CR 04 CR 21	NE 04 NE 21	AC 04 AC 21
<b>cod.</b>	<b>pz.</b>			€
<b>A7110D ...</b>	1			-

**A7110Z**

NEW

Portabicchiere con portasapone/portaoggetti da appoggio  
 Tabletop tumbler holder with soap holder/objects holder  
 Porte-verre à poser avec porte-savon/porte objets  
 Porta vaso con jabonera/porta objetos de apoyo

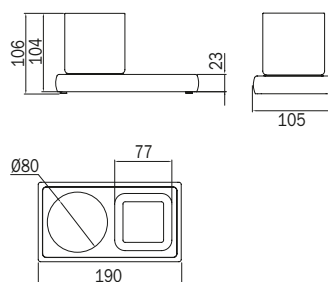

		CR 04 CR 21	NE 04 NE 21	AC 04 AC 21
<b>cod.</b>	<b>pz.</b>			€
<b>A7110Z ...</b>	1			-

**A7110W**

NEW

Portabicchiere doppio da appoggio  
 Tabletop double tumbler holder  
 Porte-verre double à poser  
 Porta vaso doble de apoyo

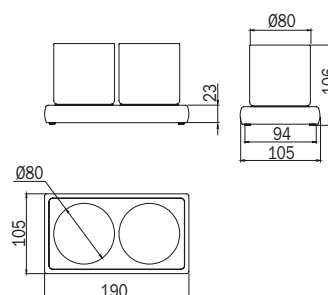

		CR 04 CR 21	NE 04 NE 21	AC 04 AC 21
<b>cod.</b>	<b>pz.</b>			€
<b>A7110W ...</b>	1			-

## CLAIRE\_7100

## A71250

NEW

Portarotolo reversibile  
Reversible paper holder  
Porte-rouleau réversible  
Porta rollo reversibile

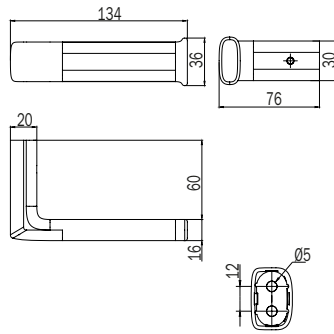

		CR	NE	AC
<b>cod.</b>	<b>pz.</b>			€
A71250 ...	1			-

## A71260

NEW

Portarotolo con coperchio basculante richiudibile  
Paper holder with tilting closeable cover  
Porte-rouleau avec couvercle rabattable  
Porta rollo con tapadera basculante con cierre

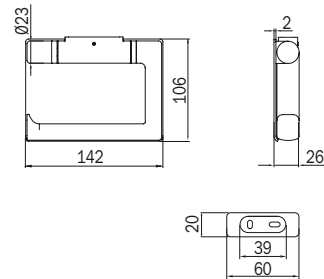

		CR	NE	AC
<b>cod.</b>	<b>pz.</b>			€
A71260 ...	1			-

## A7125B

NEW

Portarotolo basculante  
Tilting roll holder  
Porte-rouleau basculant  
Portarrollos basculante

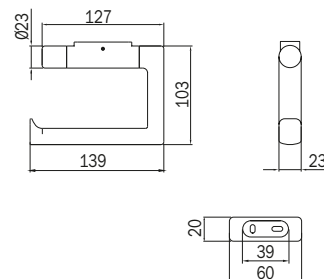

		CR	NE	AC
<b>cod.</b>	<b>pz.</b>			€
A7125B ...	1			-

**A71280****NEW**

Portarotolo di scorta doppio  
 Spare double paper holder  
 Double porte-rouleau de rechange  
 Portarollos de repuesto doble

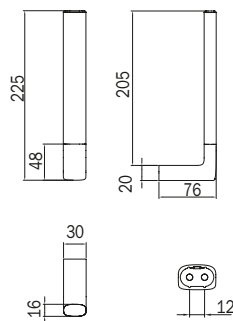

		CR	NE	AC
<b>cod.</b>	<b>pz.</b>			⌀
<b>A71280 ...</b>	1			

**A71950****NEW**

Maniglione di sicurezza  
 Safety grip  
 Barre d'appui de sécurité  
 Manillón de seguridad

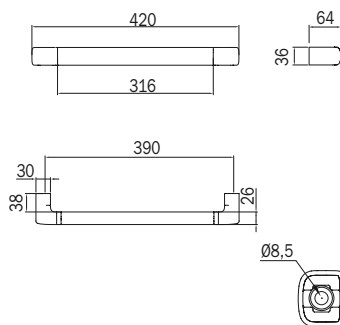

		CR	NE	AC
<b>cod.</b>	<b>pz.</b>			⌀
<b>A71950 ...</b>	1			

## INDISSIMA\_8800

**IT** Una serie versatile e pratica ma allo stesso tempo sofisticata e di grande personalità, pensata per caratterizzare l'ambiente bagno in ogni sua declinazione, grazie alle diverse finiture e all'unione di materiali differenti.

**EN** A versatile and practical series but at the same time sophisticated and of great personality, designed to characterize the bathroom environment in all its forms, thanks to the different finishes and the combination of different materials.

**FR** Une série polyvalente et pratique, à la fois sophistiquée et de grande personnalité, conçue pour caractériser l'environnement de la salle de bain sous toutes ses formes, grâce aux différentes finitions et à la combinaison de différents matériaux.

**ES** Una serie versátil y práctica pero a la vez sofisticada y de gran personalidad, diseñada para caracterizar el ambiente del baño en cada una de sus formas, gracias a la diversidad de acabados y a la combinación de diferentes materiales.

# INDISSIMA

	<b>NS</b> Acciaio inox spazzolato AISI 304 Brushed stainless steel AISI 304 Acier inoxydable brossé AISI 304 Acero inoxidable cepillado AISI 304
	<b>NE</b> Nero opaco Matt black Noir mat Negro mate
	<b>WM</b> Bianco opaco Matt white Blanc mat Blanco mate
	HPL - Laminato alta pressione HPL - High pressure laminate HPL - Stratifié haute pression HPL - Laminado alta presión





INDISSIMA  
8800





INDISSIMA  
8800



## INDISSIMA\_8800

### A8883

Barra modulare  
Modular bar  
Barre modulaire  
Barra modular

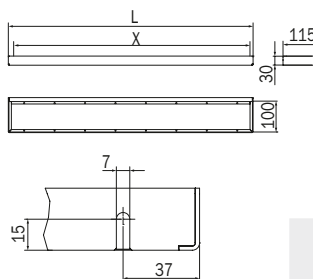

NS  
NE  
WM

cod.	L	X	pz.	€	€
A8883A ...	204	130	1	48,30	53,60
A8883B ...	304	230	1	59,00	65,50
A8883C ...	404	330	1	69,70	77,20
A8883D ...	604	530	1	85,70	94,40
A8883E ...	804	730	1	107,20	117,90
A8883F ...	1004	930	1	128,60	141,50

### A8883

Barra modulare con luce led (adatta per posizionamento sottospeschio)  
Modular bar with led light (suitable for positioning under the mirror)  
Barre modulaire avec lumière LED (convient pour le positionnement sous le miroir)  
Barra modular con luz LED (adecuada para posicionamiento bajo espejo)

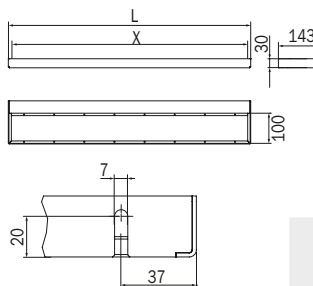
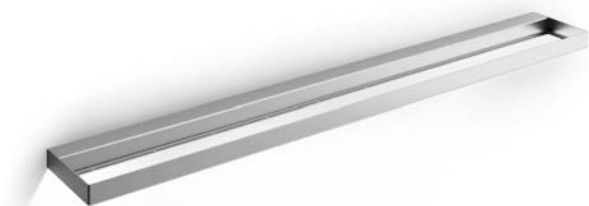

NS  
NE  
WM

cod.	L	X	pz.	€	€
A8883G ...	604	530	1	203,60	224,00
A8883H ...	804	730	1	235,70	259,30
A8883I ...	1004	930	1	267,80	294,60
A8883J ...	1204	1130	1	300,00	330,10
A8883K ...	1404	1330	1	332,10	365,40
A8883L ...	1604	1530	1	364,30	400,70



lumen 1712 lm/m 12 watt/m

### A8883

NEW

Barra modulare adatta per posizionamento sottospeschio  
Modular bar suitable for positioning under the mirror  
Barre modulable pouvant être placée sous le miroir  
Barra modular para posicionar bajo espejo

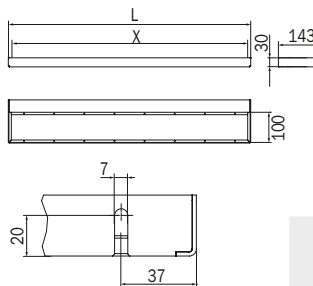

NS  
NE  
WM

cod.	L	X	pz.	€	€
A8883M ...	604	530	1	107,20	123,20
A8883N ...	804	730	1	128,60	144,70
A8883O ...	1004	930	1	150,00	171,40
A8883P ...	1204	1130	1	171,40	203,60
A8883Q ...	1404	1330	1	192,90	225,00
A8883R ...	1604	1530	1	225,00	262,50



**A8818**

Modulo portasalviette  
Towel holder module  
Module porte serviette  
Mòdulo toallero

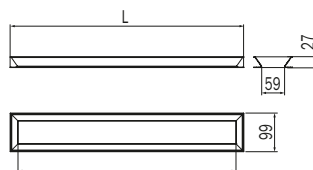
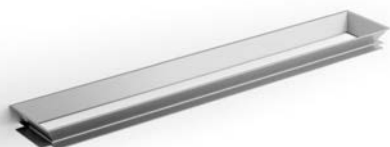

cod.	L	pz.	€	NS	NE WM
A8818M ...	299	1	48,30	53,10	
A8818N ...	399	1	59,00	65,50	
A8818R ...	599	1	75,00	82,60	
A8818S ...	799	1	91,10	100,80	

**A8812M**

Modulo spandisapone  
Soap spreading module  
Module d'épandage de savon  
Mòdulo dosificador de Jabon liquido

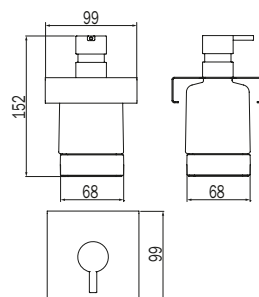

cod.	L	pz.	€	NS 21	NE 21 WM 21
A8812M ...	100	1	91,10	100,80	

0,25 Lt.

**A8867M**

Modulo spandisapone a leva  
Soap dispenser module with lever  
Module d'épandage de savon avec lever  
Mòdulo dosificador de Jabon liquido con leva

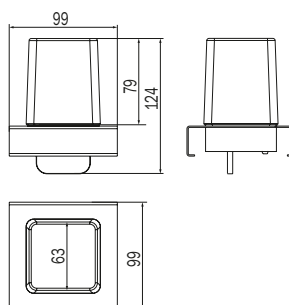

cod.	L	pz.	€	NS 21	NE 21 WM 21
A8867M ...	100	1	96,50	106,10	

0,18 Lt.

## INDISSIMA\_8800

### A8810M

Modulo bicchiere  
Glass module  
Module de verre  
Módulo vaso

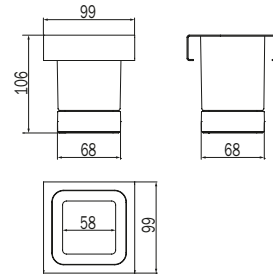

cod.	L	pz.	NS 21		NE 21 WM 21	
			€	€	€	€
A8810M ...	100	1	73,00	80,40		

### A8810N

NEW

Modulo bicchiere  
Glass module  
Module de verre  
Módulo vaso

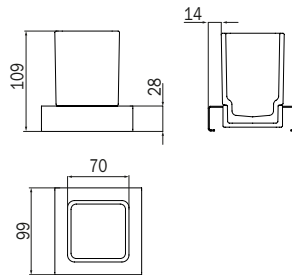

cod.	L	pz.	NS 21		NE 21 WM 21	
			€	€	€	€
A8810N ...	100	1	67,00	73,00		

### A8826M

SX

Modulo portarotolo destro o sinistro con coperchio  
Right or left roll holder module with lid  
Module porte-rouleau droit ou gauche avec couvercle  
Módulo porta rollos derecho o izquierdo con tapa

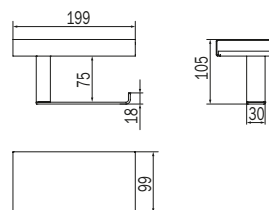

### A8826N

DX



cod.	L	pz.	NS		NE WM		*NS+HPL		*NE+HPL *WM+HPL	
			€	€	€	€	€	€		
A8826M ...	200	1	75,00	82,60	107,20	117,90				
A8826N ...	200	1	75,00	82,60	107,20	117,90				

**A8851M**

Modulo cestino  
Basket module  
Module de corbeille  
Mòdulo cesta

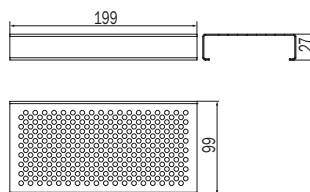

cod.	L	pz.	NS		NE WM	
			€	€	€	€
A8851M ...	200	1	42,90	47,20		

**A8851N**

Modulo cestino basso  
Low basket module  
Module panier bas  
Mòdulo cesta bajo

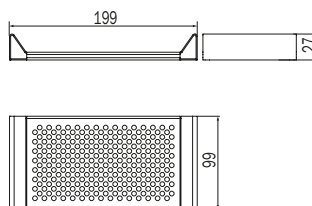

cod.	L	pz.	NS		NE WM	
			€	€	€	€
A8851N ...	200	1	42,90	47,20		

**A8809**

Modulo mensola bassa  
Low shelf module  
Module d'étagère basse  
Mòdulo estante bajo

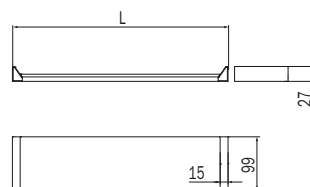

cod.	L	pz.	NS		NE WM		*NS+HPL		*NE+HPL *WM+HPL	
			€	€	€	€	€	€		
A8809N ...	200	1	42,90	47,20	75,00	82,60				
A8809S ...	400	1	64,30	70,80	101,80	112,50				

## INDISSIMA\_8800

### A8809

Modulo mensola  
Shelf module  
Module d'étagère  
Módulo estante

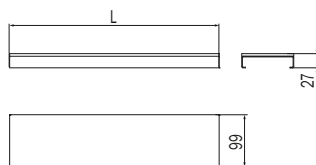

cod.	L	pz.				
			NS	NE WM	*NS+HPL	*NE+HPL *WM+HPL
			€	€	€	€
A8809M ...	200	1	42,90	47,20	78,30	
A8809R ...	400	1	64,30	70,80	96,50	

### A8842M

Modulo porta sacchetti igienici  
Hygienic bag holder module  
Module porte-sac hygiénique  
Módulo porta bolsas higienicasuierdo

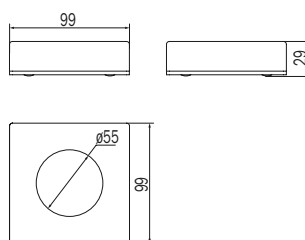

cod.	L	pz.		
			NS	NE WM
			€	€
A8842M ...	100	1	37,50	41,40

### A8801M

Modulo gettacarta  
Paper basket module  
Module poubelle  
Módulo papelera

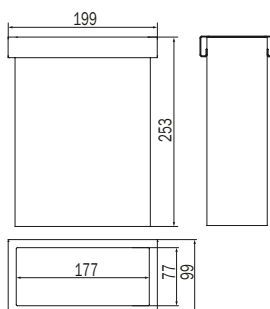

cod.	L	pz.		
			NS	NE WM
			€	€
A8801M ...	200	1	128,60	141,50

Per la versione NE+HPL e WM+HPL prendere il codice del NS+HPL: modulo compatibile con tutte le barre in finitura NS, NE e WM  
 For the NE + HPL and WM + HPL version take the NS + HPL code: module compatible with all bars in NS, NE and WM finish  
 Pour les versions NE + HPL et WM + HPL, prenez le code NS + HPL: module compatible avec toutes les barres en finition NS, NE et WM  
 Para las versiones NE-HPL y WM-HPL, tome el código del NS-HPL: módulo compatible con todas las barras en acabado NS, NE y WM

## A8814M

Modulo portascopino con fondello estraibile  
 Brush holder module with removable bottom  
 Module porte-balais avec fond amovible  
 Módulo portaescobilla con fondo extraíble

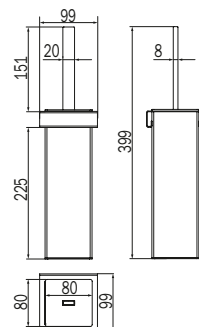

cod.	L	pz.	NS		NE WM	
			€	€		
A8814M ...	100	1	139,30	153,30		

## A8818

Portasalviette  
 Towel holder  
 Porte-serviettes  
 Toallero

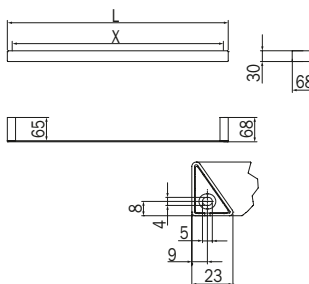
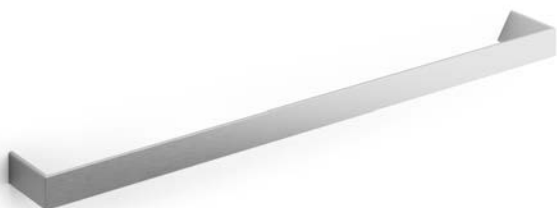

cod.	L	X	pz.	NS		NE WM	
				€	€		
A8818B ...	417	400	1	80,40	89,00		
A8818C ...	617	600	1	91,10	100,80		
A8818D ...	817	800	1	101,80	112,50		

click

## A88150

Portasalviette fisso a bandiera  
 Fixed towel holder  
 Porte-serviettes fixe à drapeau  
 Toallero fijo a bandera

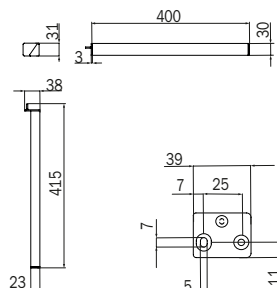
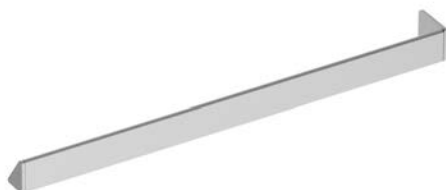

cod.	pz.	NS		NE WM	
		€	€		
A88150 ...	1	58,60	63,70		

click

## INDISSIMA\_8800

### A88680

Portateli  
Bath towel rack  
Rack porte-serviettes  
Toallero/Repisa con toallero

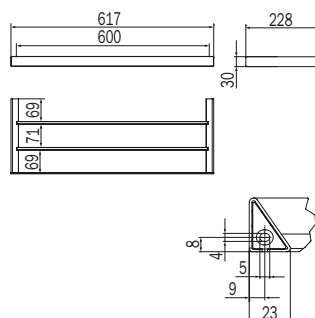

		NS		NE WM	
cod.	pz.	€	€	€	€
A88680 ...	1	160,70		176,80	

### A8820A

Appendiabiti  
Clothes hanger  
Patère  
Percha

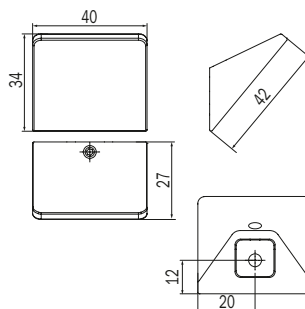

		NS		NE WM	
cod.	pz.	€	€	€	€
A8820A ...	1	26,80		30,10	

### A88670

NEW

Spandisapone a leva a parete con contenitore in vetro satinato, leva in finitura  
Wall-mounted lever soap dispenser with satined glass container, lever in finish  
Distributeur de savon à levier mural avec récipient en verre dépoli, levier en finition  
Jabonera a palanca para pared con contenedor en cristal satinado, palanca en acabado

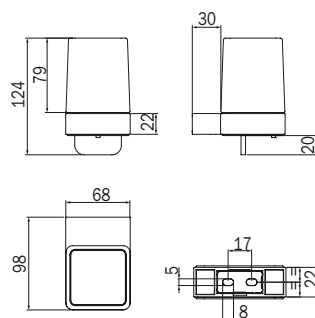

		NS 21		NE 21 WM 21	
cod.	pz.	€	€	€	€
A88670 ...	1	96,00		105,10	

click

0,18 Lt.

**A88120**

NEW

Spandisapone a parete con contenitore in vetro satinato, erogatore in finitura  
 Wall-mounted soap dispenser with satined glass container and in finish brass pump  
 Distributeur de savon mural avec pot en verre satiné, doseur en finition  
 Dosificador de jabón líquido de pared con recipiente de vidrio satinado, dispensador en acabado

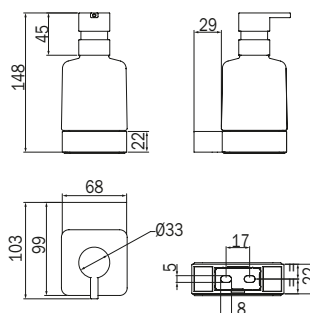

		NS 21		NE 21 WM 21	
cod.	pz.	€	€	€	€
A88120 ...	1	85,90		94,00	

click

0,25 Lt.

**A88100**

NEW

Portabicchiere a parete con bicchiere in vetro satinato  
 Wall-mounted tumbler holder with satined glass tumbler  
 Porte-verre mural avec verre en verre satiné  
 Portavasos de pared con vaso de vidrio satinado

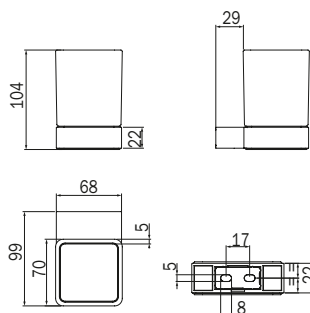

		NS 21		NE 21 WM 21	
cod.	pz.	€	€	€	€
A88100 ...	1	62,70		68,70	

click

**A88110**

NEW

Portasapone a parete con bacinella in vetro satinato  
 Wall-mounted soap holder with satined glass dish  
 Porte-savon mural avec coupelle en verre satiné  
 Jabonera de pared con cubeta de vidrio satinado

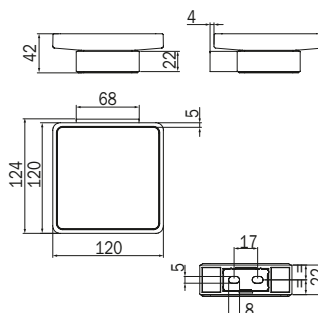

		NS 21		NE 21 WM 21	
cod.	pz.	€	€	€	€
A88110 ...	1	62,70		68,70	

click

## INDISSIMA\_8800

**A8825A**

DX

Portarotolo  
Paper holder  
Porte-rouleau  
Portarrollos

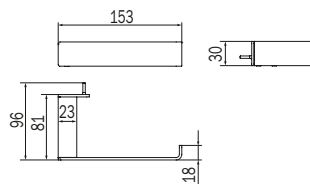
**A88250**

SX

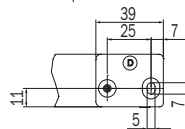

		NS		NE WM	
cod.	pz.	€	€	€	€
<b>A8825A ...</b>	1	53,60	59,00		
<b>A88250 ...</b>	1	53,60	59,00		

**A88280**

**NEW**  
05.2022

Portarotolo di scorta doppio  
Spare double paper holder  
Double porte-rouleau de rechange  
Portarrollos de repuesto doble

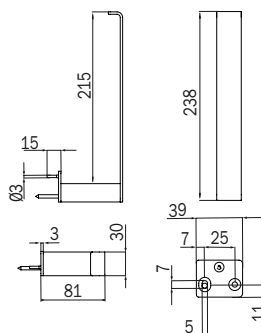

		NS		NE WM	
cod.	pz.	€	€	€	€
<b>A88280 ...</b>	1	63,70	69,70		

**A88510**

Cestino  
Basket  
Panier  
Jabonera

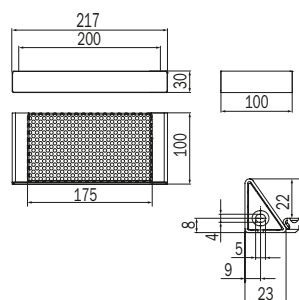
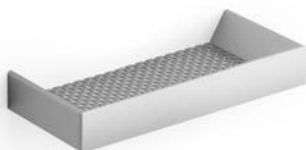

		NS		NE WM	
cod.	pz.	€	€	€	€
<b>A88510 ...</b>	1	75,00	82,60		

click



**AV114A**

Portascopino da parete/da appoggio  
 Wall mounted/free-standing toilet brush holder  
 Porte-balai mural/à poser  
 Escobillero de pared/de suelo

NEW

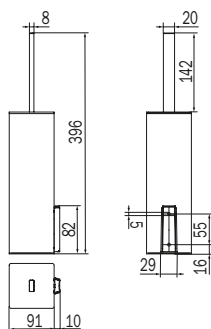
AS  
WM

cod.	pz.	€
AV114A ...	1	211,10

**AV114B**

Portascopino da parete/da appoggio  
 Wall mounted/free-standing toilet brush holder  
 Porte-balai mural/à poser  
 Escobillero de pared/de suelo

NEW

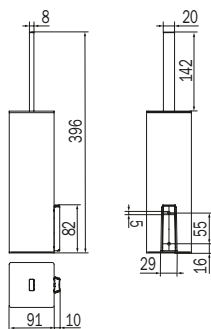

NE

cod.	pz.	€
AV114B ...	1	211,10



# INDISSIMA CHROME

## INDISSIMA CHROME\_8800

- IT Un'accurata selezione di accessori Indissima anche in finitura cromata, perfetta per adattarsi facilmente a tutte le stanze da bagno dallo stile moderno e minimale.
- EN A rigorous selection of Indissima accessories also in a chrome finish, perfect for easily adapting to any bathroom with a modern and minimal style.
- FR Une sélection rigoureuse d'accessoires Indissima également dans une finition chromée, parfaite pour s'adapter facilement à toutes les salles de bains avec un style moderne et minimal.
- ES Una cuidada selección de accesorios de Indissima también en acabado cromado, perfecta para adaptarse fácilmente a todos los baños con un estilo moderno y minimalista.



**CR** Cromato  
Chrome-plated  
Chromé  
Cromado









INDISSIMA CHROME  
8800





INDISSIMA CHROME  
8800

## INDISSIMA\_CHROME

### A8818

Portasalviette  
Towel holder  
Porte-serviettes  
Toallero

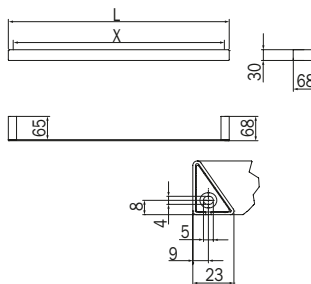

click

cod.	L	X	pz.	€	CR
A8818B ...	417	400	1	75,00	
A8818C ...	617	600	1	87,90	
A8818D ...	817	800	1	99,80	

### A88150

Portasalviette fisso a bandiera  
Fixed towel holder  
Porte-serviettes fixe à drapeau  
Toallero fijo a bandera

NEW  
05.2022

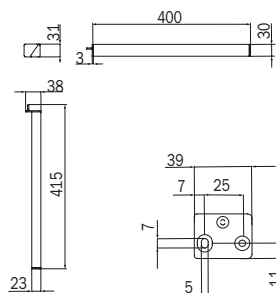

click

cod.	pz.	€	CR
A88150 ...	1	55,60	

### A88680

Portateli  
Bath towel rack  
Rack porte-serviettes  
Toallero/Repisa con toallero

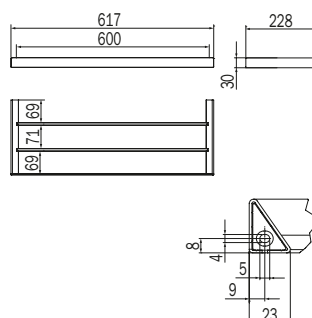

cod.	pz.	€	CR
A88680 ...	1	150,00	



**A8820A**

Appendiabiti  
Clothes hanger  
Patère  
Percha

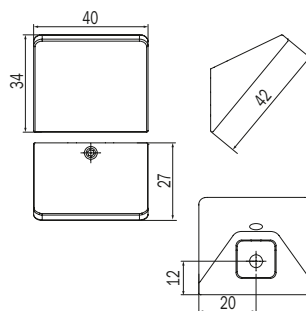

			CR
cod.	pz.	€	
<b>A8820A ...</b>	1	<b>23,60</b>	

**A88K20**

Set lavabo (spandisapone a leva con portabicchiere)  
Washbasin set (lever soap dispenser with tumbler holder)  
Set de lavabo (distributeur de savon à levier avec porte-verre)  
Set lavabo (dosificador con porta vasos)

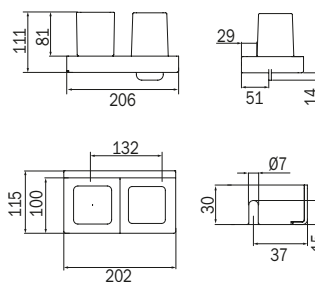

			CR 21	
cod.	L	X	pz.	€
<b>A88K20 ...</b>	<b>204</b>	130	1	<b>210,00</b>

**A88K30**

Set lavabo (spandisapone con portabicchiere)  
Washbasin set (soap dispenser with tumbler holder)  
Set de lavabo (distributeur de savon avec porte-verre)  
Set lavabo (dosificador con porta vasos)

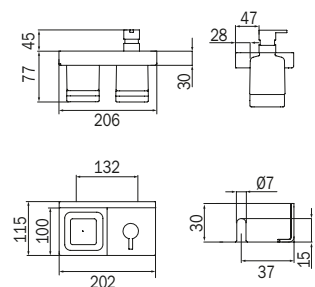

			CR 21	
cod.	L	X	pz.	€
<b>A88K30 ...</b>	<b>204</b>	130	1	<b>205,00</b>

## INDISSIMA\_CHROME

### A88K40



Set lavabo (spandisapone con portabicchiere e mensola)  
 Washbasin set (soap dispenser with tumbler holder and shelf)  
 Set de lavabo (distributeur de savon avec porte-verre et étagère)  
 Set lavabo (dosificador con porta vasos)

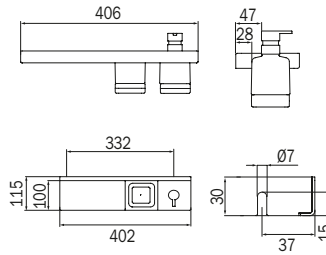

				CR 21
cod.	L	X	pz.	€
A88K40 ...	404	330	1	260,00

### A88670

Spandisapone a leva a parete con contenitore in vetro satinato, leva in finitura  
 Wall-mounted lever soap dispenser with satinated glass container, lever in finish  
 Distributeur de savon à levier mural avec récipient en verre dépoli, levier en finition  
 Jabonera a palanca para pared con contenedor en cristal satinado, palanca en acabado

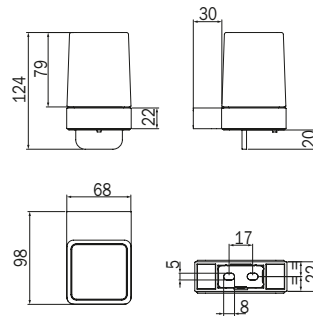

				CR 21
cod.			pz.	€
A88670 ...			1	91,10



### A88120

Spandisapone a parete con contenitore in vetro satinato, erogatore in finitura  
 Wall-mounted soap dispenser with satinated glass container and in finish brass pump  
 Distributeur de savon mural avec pot en verre satiné, doseur en finition  
 Dosificador de jabón líquido de pared con recipiente de vidrio satinado, dispensador en acabado

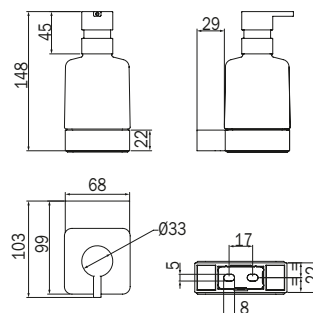

				CR 21
cod.			pz.	€
A88120 ...			1	80,40



**A88100**

Portabicchiere a parete con bicchiere in vetro satinato  
 Wall-mounted tumbler holder with satined glass tumbler  
 Porte-verre mural avec verre en verre satiné  
 Portavasos de pared con vaso de vidrio satinado

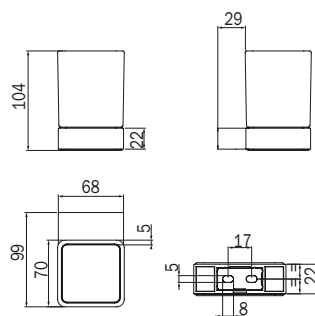

click

		CR 21
cod.	pz.	€
A88100 ...	1	59,00

**A88110**

Portasapone a parete con bacinella in vetro satinato  
 Wall-mounted soap holder with satined glass dish  
 Porte-savon mural avec coupelle en verre satiné  
 Jabonera de pared con cubeta de vidrio satinado

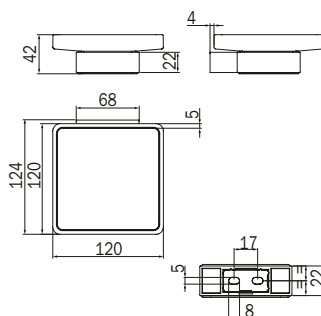

click

		CR 21
cod.	pz.	€
A88110 ...	1	59,00

**A88K5A**

Portarotolo destro o sinistro con coperchio  
 Right or left roll holder with lid  
 Porte-rouleau droit ou gauche avec couvercle  
 Portarrollos derecho o izquierdo con tapa

**NEW** 05.2022

DX

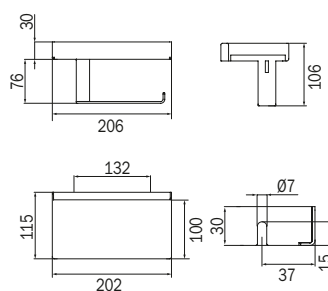
**A88K5B**

SX



				CR
cod.	L	X	pz.	€
A88K5A ...	204	130	1	130,00
A88K5B ...	204	130	1	130,00

## INDISSIMA\_CHROME

### A8825A

DX

Portarotolo  
Paper holder  
Porte-rouleau  
Portarrollos

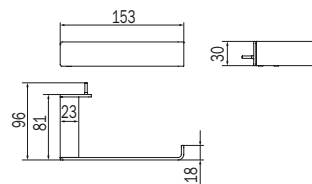

### A88250

SX

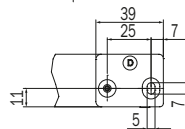

		CR
cod.	pz.	€
A8825A ...	1	51,50
A88250 ...	1	51,50

### A88280



Portarotolo di scorta doppio  
Spare double paper holder  
Double porte-rouleau de rechange  
Portarrollos de reserva doble

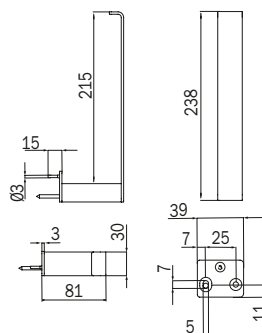

		CR
cod.	pz.	€
A88280 ...	1	60,60

### A88510

Cestino  
Basket  
Panier porte-savon  
Jabonera de rejilla

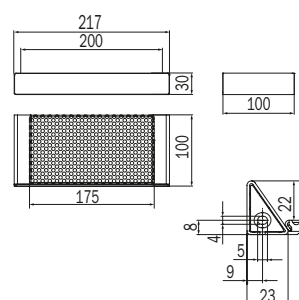

		CR
cod.	pz.	€
A88510 ...	1	75,00

[click](#)

**AV114A**

Portascopino da parete/da appoggio  
 Wall mounted/free-standing toilet brush holder  
 Porte-balai mural/à poser  
 Escobillero de pared/de suelo

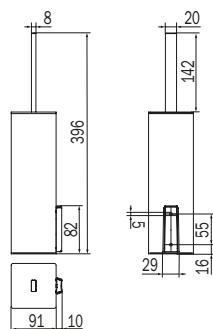

cod.	pz.	€
AV114A ...	1	177,90

CR

**AV114B**

Portascopino da parete/da appoggio  
 Wall mounted/free-standing toilet brush holder  
 Porte-balai mural/à poser  
 Escobillero de pared/de suelo

NEW

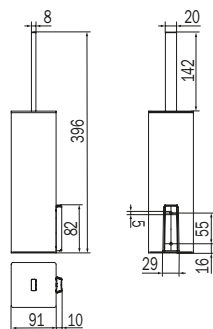

cod.	pz.	€
AV114B ...	1	177,90

CR

## GEALUNA\_1000

**IT** Un'estetica estremamente essenziale e di grande eleganza, con l'utilizzo di materiali di assoluta qualità, è la caratteristica principale di Gealuna, una collezione dal design rigoroso, distinto da linee nette e pulite. La serie può essere montata a parete utilizzando la colla per evitare la foratura delle ceramiche oppure con viti e tasselli.

**EN** An extremely essential look and of great elegance with the use of absolute top quality materials. Gealuna rigorous design, stands out for its clean, sharp lines. The series can be mounted to the wall using glue does not require to make a hole of ceramics or with screws and dowels.

**FR** Un esthétisme extrêmement essentiel et de grande élégance, avec l'utilisation de matériaux de qualité absolue. Caractéristique principale de Gealuna, une collection au design rigoureux, distinct par des lignes épurées et simples. La série peut être montée au mur en utilisant la colle afin d'éviter de percer le carrelage ou bien avec des vis et chevilles.

**ES** Una estética sumamente esencial y de gran elegancia, con el empleo de materiales de absoluta calidad. Gealuna, diseño riguroso caracterizado por unas líneas netas y pulidas que se pueden también encolar a la pared ofreciendo una consistencia que no requiere el anclaje a las baldosas.



**CR** Cromato  
Chrome-plated  
Chromé  
Cromado

**NS** Acciaio inox spazzolato AISI 304  
Brushed stainless steel AISI 304  
Acier inoxydable brossé AISI 304  
Acero inoxidable cepillado AISI 304

# GEALUNA





GEALUNA  
1000











GEALUNA  
1000

## GEALUNA\_1000

## A1018

Portasalviette  
Towel holder  
Porte-serviettes  
Toallero

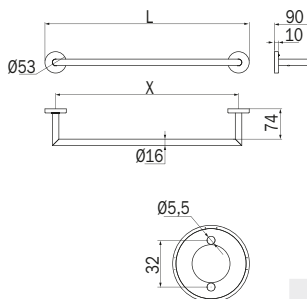

cod.	L	X	pz.	CR		NS	
				€	€	€	€
A1018A ...	352	300	1	63,90	70,40		
A1018B ...	502	450	1	68,30	75,20		
A1018C ...	652	600	1	72,70	79,90		
A1018D ...	852	800	1	105,10	115,60		

click



## A1018

Portasalviette senza placca a muro  
Towel holder without wall plate  
Porte-serviettes sans plaque murale  
Toallero sin placa a muro

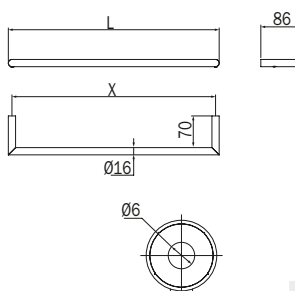

cod.	L	X	pz.	CR		NS	
				€	€	€	€
A1018E ...	316	300	1	67,20	73,90		
A1018F ...	466	450	1	70,80	77,90		
A1018G ...	616	600	1	76,30	84,00		
A1018H ...	816	800	1	110,40	121,40		

click

## A1019

Portasalviette doppio  
Double towel holder  
Porte-serviettes double  
Toallero doble

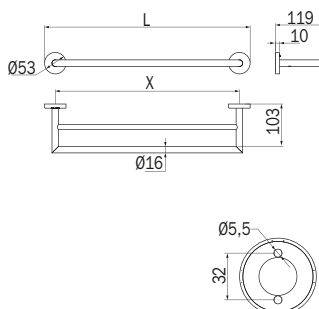

cod.	L	X	pz.	CR		NS	
				€	€	€	€
A1019B ...	502	450	1	104,00	114,40		
A1019C ...	652	600	1	118,10	129,90		

click



**A1019**

Portasalviette doppio senza placca a muro  
 Double towel holder without wall plate  
 Porte-serviettes double sans plaque murale  
 Toallero doble sin placa a muro

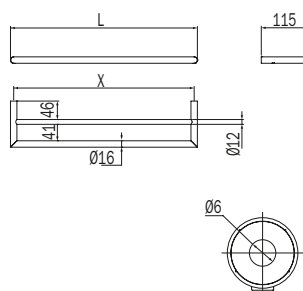

click

cod.	L	X	pz.	€	NS
A1019F ...	466	450	1	109,20	120,10
A1019G ...	616	600	1	124,00	136,30

**A10150**

Portasalviette doppio a snodo  
 Double swing arm towel holder  
 Porte-serviettes double mobile  
 Toallero doble articulado

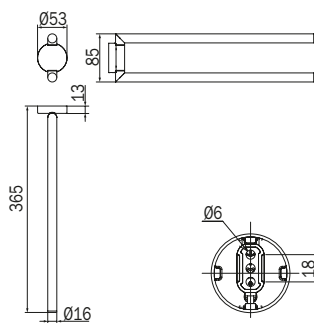

cod.	pz.	€	NS
A10150 ...	1	144,00	158,60

**A10160**

Portasalviette ad anello  
 Ring towel holder  
 Porte-serviette anneau  
 Toallero de aro

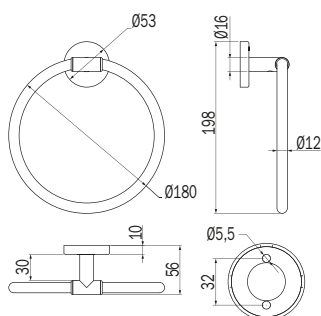

cod.	pz.	€	NS
A10160 ...	1	55,40	60,90

click





**A1020C**

Appendiabiti  
Clothes hanger  
Patère  
Percha

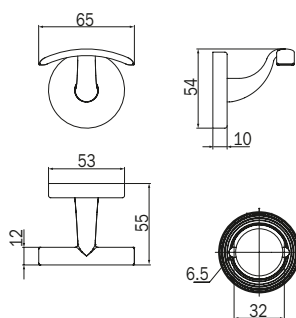

		CR	NS
cod.	pz.	€	€
<b>A1020C ...</b>	1	24,70	27,10

**A10120****NEW**

Spandisapone a parete con contenitore in vetro extrachiario trasparente, erogatore in finitura  
Wall-mounted soap dispenser with extra clear transparent glass container and in finish brass pump  
Distributeur de savon mural avec pot en verre transparent extra clair, doseur en finition  
Dosificador de jabón líquido de pared con recipiente de vidrio transparente extraclaro, dispensador en acabado

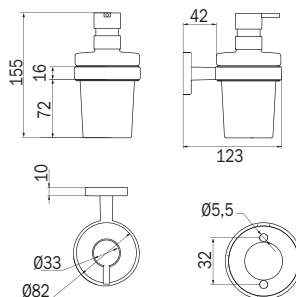

		CR 03	NS 03
cod.	pz.	€	€
<b>A10120 ...</b>	1	83,50	92,00

click

0,25 Lt.

**A1010A****NEW**

Portabicchiere a parete con bicchiere in vetro extrachiario trasparente  
Wall-mounted tumbler holder with extra clear transparent glass tumbler  
Porte-verre mural avec verre en verre transparent extra clair  
Portavasos de pared con vaso de vidrio extraclaro transparente

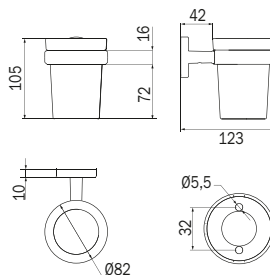

		CR 03	NS 03
cod.	pz.	€	€
<b>A1010A ...</b>	1	55,40	61,00

click



## GEALUNA\_1000

### A10110

NEW

Portasapone a parete con bacinella in vetro extrachiaro trasparente  
 Wall-mounted soap holder with extra clear transparent glass dish  
 Porte-savon mural avec coupelle en verre transparent extra clair  
 Jabonera de pared con cubeta de vidrio extraclaro transparente

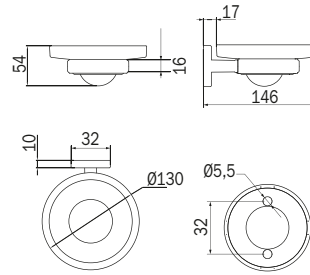

		CR 03	NS 03
cod.	pz.	€	€
A10110 ...	1	55,40	61,00

### A1025A

SX

Portarotolo  
 Paper holder  
 Porte-rouleau  
 Portarrollos

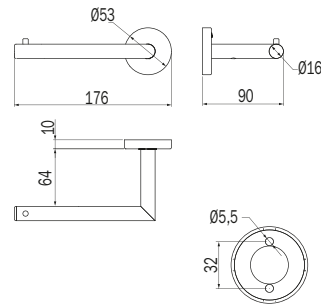

### A1025D

DX



		CR	NS
cod.	pz.	€	€
A1025A ...	1	55,40	60,90
A1025D ...	1	55,40	60,90

### A1025B

Portarotolo basculante  
 Tilting roll holder  
 Porte-rouleau basculant  
 Portarrollos basculante

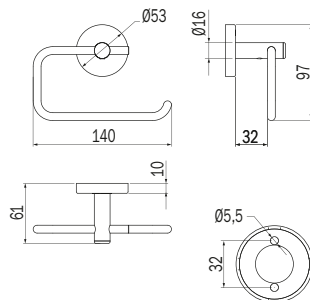

		CR	NS
cod.	pz.	€	€
A1025B ...	1	55,40	60,90



**A1025C**

Portarotolo doppio  
Double paper holder  
Porte-rouleau double  
Portarrollos doble

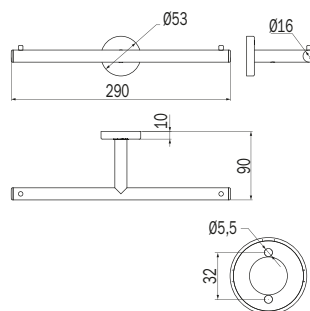

		CR	NS
cod.	pz.	€	€
A1025C ...	1	71,50	78,70

**A10260**

Portarotolo basculante con coperchio  
Tilting roll holder with cover  
Porte-rouleau basculant avec couvercle  
Portarrollos basculante con tapa

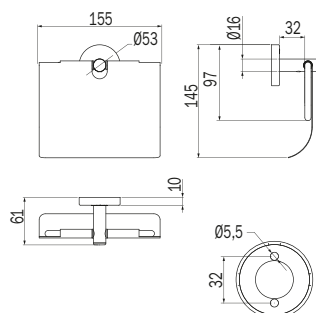

		CR	NS
cod.	pz.	€	€
A10260 ...	1	74,70	82,20

**A10280**

Portarotolo di scorta  
Spare roll holder  
Porte-rouleau réserve  
Portarrollos de repuesto

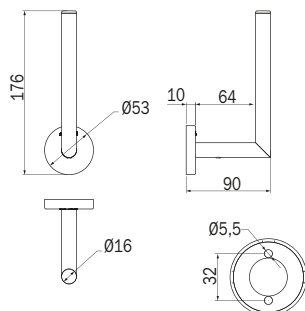

		CR	NS
cod.	pz.	€	€
A10280 ...	1	55,40	60,90

# GEALUNA\_1000

## A1031B

Angolare  
Corner  
Porte-objets d'angle  
Jabonera angular

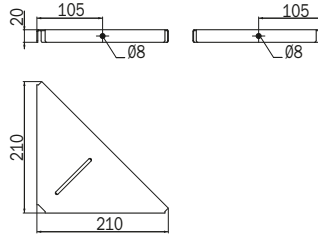

		CR	NS
cod.	pz.	€	€
A1031B ...	1	68,30	75,20

## A1051B

Cestino  
Basket  
Panier porte-savon  
Jabonera

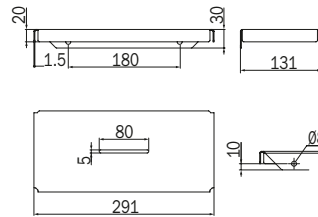

		CR	NS
cod.	pz.	€	€
A1051B ...	1	81,30	89,50

## A10950

Maniglione di sicurezza  
Safety grip  
Barre d'appui de sécurité  
Manillón de seguridad

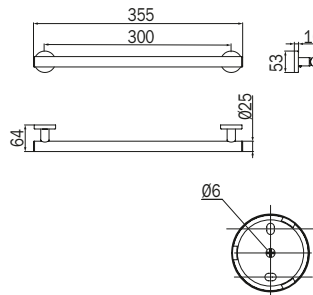

		CR	NS		
cod.	L	X	pz.	€	€
A10950 ...	355	300	1	79,20	87,10

**A1095**

Maniglione di sicurezza  
Safety grip  
Barre d'appui de sécurité  
Manillón de seguridad

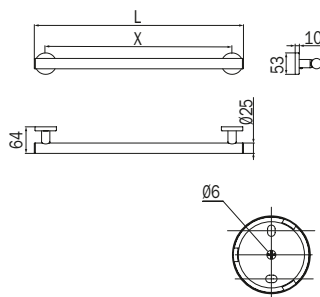

1.500N  
~150Kg

cod.	L	X	pz.	€	CR
<b>A1095B ...</b>	<b>505</b>	450	1	84,50	
<b>A1095C ...</b>	<b>655</b>	600	1	93,20	

**AV014A**

Portascopino da parete/da appoggio. Scovolo di ricambio bianco incluso  
Wall mounted/free-standing toilet brush holder. White spare brush included  
Porte-balai mural/à poser. Balayette de rechange blanche incluse  
Escobillero de pared/de suelo. Escobilla de repuesto blanca incluida

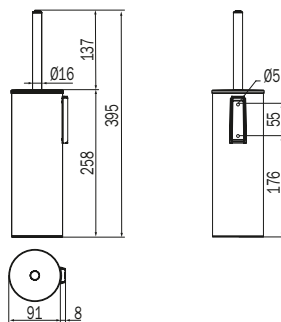

cod.	pz.	€	CR	AS
<b>AV014A ...</b>	1	100,80	116,90	

**R10000A**

NEW

Colla bicomponente (posa rapida). Una confezione è sufficiente per 2 placche  
Two-component adhesive (quick installation). One package is enough for two plaques.  
Adhésif bi-composant (montage rapide) Un kit suffit pour 2 plaques  
Pegamento bicomponente (instalación rápida). Un paquete es suficiente para 2 punto de fijacion

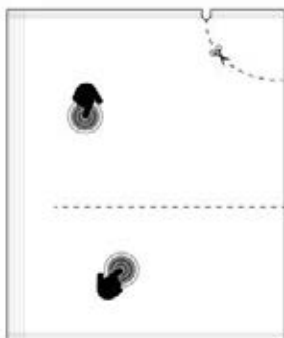

cod.	pz.	€
<b>R10000A</b>	1	9,10

4h

## MITO\_2000

**IT** Mito è una serie di accessori in ottone cromato indicata per arredare con semplicità ed eleganza. Grazie ad un innovativo sistema di fissaggio a "scatto", il montaggio a parete viene estremamente facilitato.

**EN** Mito is a series of accessories in chromium plated brass to furnish with simplicity and elegance; thanks to an innovative fixing system "clip", the wall assembly is extremely facilitated.

**FR** Mito, série d'accessoires en laiton chromé adaptée pour un aménagement simple et élégant. Grâce à un système innovant de fixation « clipsable », l'installation murale est extrêmement simplifiée.

**ES** Mito, serie de accesorios en latón cromado para decorar con sencillez y elegancia; gracias a un novedoso sistema de fijación a "click", el montaje a pared se facilita intensamente.



	<b>CR</b> Cromato Chrome-plated Chromé Cromado
	<b>AC</b> Nickel spazzolato Brushed nickel Nickel brossé Níquel cepillado
	<b>WM</b> Bianco opaco Matt white Blanc mat Blanco mate
	<b>NE</b> Nero opaco Matt black Noir mat Negro mate















## MITO\_2000

## A2018

NEW

Portasalviette  
Portasalviette  
Porte-serviettes  
Toallero

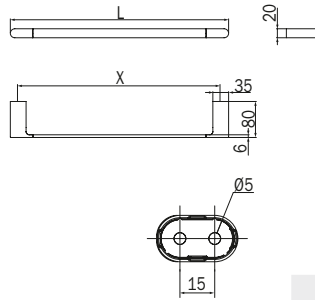

				CR	NE WM	AC
cod.	L	X	pz.	€	€	€
A2018A ...	335	300	1	67,30	77,60	94,40
A2018B ...	485	450	1	70,50	81,20	98,80
A2018C ...	635	600	1	77,00	88,60	107,80
A2018D ...	835	800	1	88,90	102,50	124,70

click

## A20150

NEW

Portasalviette doppio a snodo  
Double swing arm towel holder  
Porte-serviettes double mobile  
Toallero doble articulado

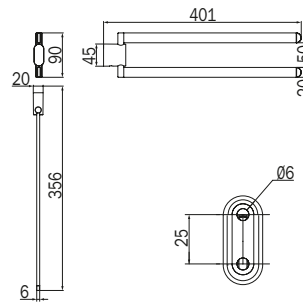

			CR	NE WM	AC
cod.	pz.	€	€	€	€
A20150 ...	1	137,60	160,30	172,20	

## A20160

NEW

Portasalviette ad anello  
Ring towel holder  
Porte-serviette anneau  
Toallero de aro

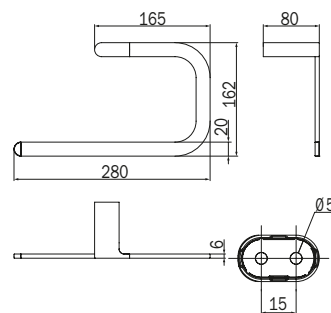
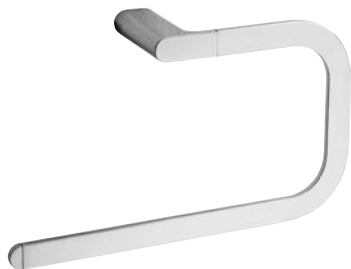

			CR	NE WM	AC
cod.	pz.	€	€	€	€
A20160 ...	1	77,00	90,00	115,90	

click

**A2018M**

NEW

Portasalviette laterale per mobile (reversibile)  
Lateral towel holder for cabinet (reversible)  
Porte-serviettes latéral pour meubles (réversible)  
Toallero lateral para muebles (reversible)

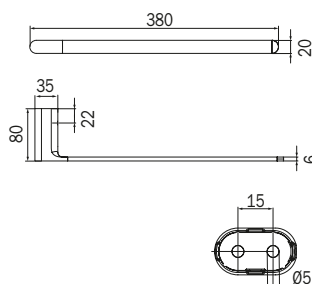

click

REV

cod.	pz.			
		CR	NE WM	AC
		€	€	€
<b>A2018M ...</b>	1	72,80	83,90	97,00

**A2020A**

Appendiabiti  
Clothes hanger  
Patère  
Percha

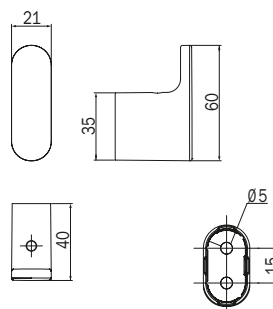

click

cod.	pz.			
		CR	NE WM	AC
		€	€	€
<b>A2020A ...</b>	1	28,50	31,50	35,70

**A2020B**

Appendiabiti doppio  
Double clothes hanger  
Patère double  
Percha doble

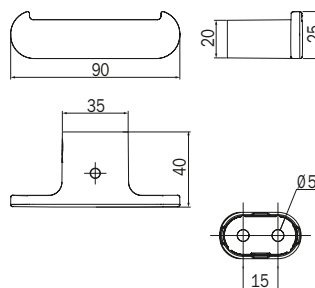

click

cod.	pz.			
		CR	NE WM	AC
		€	€	€
<b>A2020B ...</b>	1	35,50	39,10	44,40

## MITO\_2000

## A20670

NEW

Spandisapone a leva a parete con contenitore in vetro satinato, leva in finitura  
 Wall-mounted lever soap dispenser with satined glass container, lever in finish  
 Distributeur de savon à levier mural avec récipient en verre dépoli, levier en finition  
 Jabonera a palanca para pared con contenedor en cristal satinado, palanca en acabado

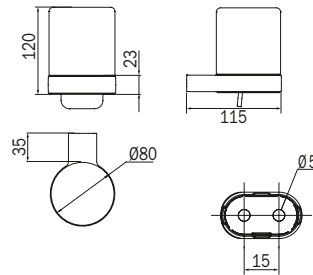

click

0,25 Lt.

cod.	pz.			
		CR 21	NE 21 WM 21	AC 21
A20670 ...	1	90,00	103,00	121,00

## A20120

NEW

Spandisapone a parete con contenitore in vetro satinato, erogatore in finitura  
 Wall-mounted soap dispenser with satined glass container and in finish brass pump  
 Distributeur de savon mural avec pot en verre satiné, doseur en finition  
 Dosificador de jabón líquido de pared con recipiente de vidrio satinado, dispensador en acabado

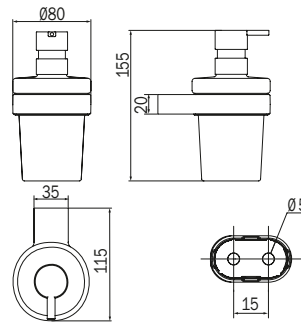

0,25 Lt.

click

cod.	pz.			
		CR 21	NE 21 WM 21	AC 21
A20120 ...	1	79,20	91,20	103,10

## A2012B

NEW

Spandisapone a parete con contenitore in vetro satinato, erogatore in finitura  
 Wall-mounted soap dispenser with satined glass container and in finish brass pump  
 Distributeur de savon mural avec pot en verre satiné, doseur en finition  
 Dosificador de jabón líquido de pared con recipiente de vidrio satinado, dispensador en acabado

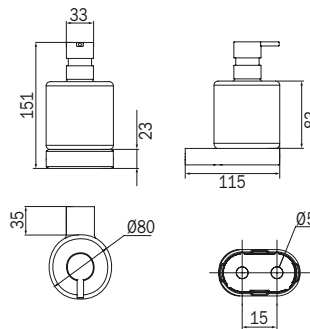

0,35 Lt.

cod.	pz.			
		CR 21	NE 21 WM 21	AC 21
A2012B ...	1	89,10	102,30	121,00

**A20100**

NEW

Portabicchiere a parete con bicchiere in vetro satinato  
 Wall-mounted tumbler holder with satined glass tumbler  
 Porte-verre mural avec verre en verre satiné  
 Portavasos de pared con vaso de vidrio satinado

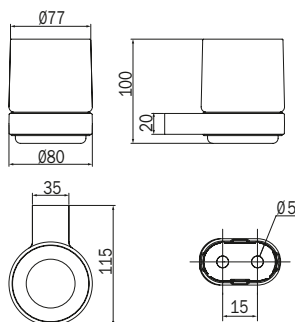

		CR 21	NE 21 WM 21	AC 21
<b>cod.</b>	<b>pz.</b>	€	€	€
<b>A20100 ...</b>	1	51,50	59,30	67,00

click

**A20110**

NEW

Portasapone a parete con bacinella in vetro satinato  
 Wall-mounted soap holder with satined glass dish  
 Porte-savon mural avec coupelle en verre satiné  
 Jabonera de pared con cubeta de vidrio satinado

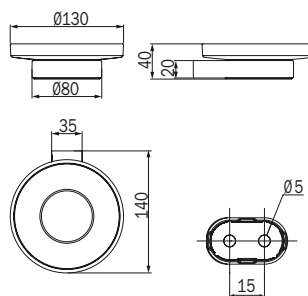

		CR 21	NE 21 WM 21	AC 21
<b>cod.</b>	<b>pz.</b>	€	€	€
<b>A20110 ...</b>	1	53,50	61,70	69,60

click

**A20010**

Portabicchiere da appoggio con bicchiere in vetro satinato  
 Tabletop tumbler holder with satined glass tumbler  
 Porte-verre à poser, avec verre en verre satiné  
 Portavasos de apoyo con vaso de vidrio satinado

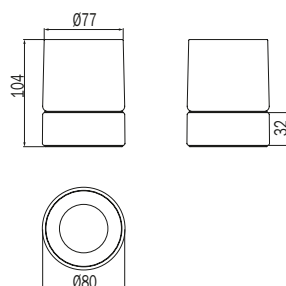

		CR 21	NE 21 WM 21	AC 21
<b>cod.</b>	<b>pz.</b>	€	€	€
<b>A20010 ...</b>	1	41,40	47,70	53,90

## MITO\_2000

## A20020

Portasapone da appoggio con bacinella in vetro satinato  
 Tabletop soap holder with satined glass dish  
 Porte-savon à poser, avec coupelle en verre satiné  
 Jabonera de apoyo con cubeta de vidrio satinado

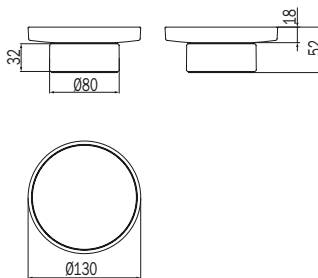

		CR 21	NE 21 WM 21	AC 21
<b>cod.</b>	<b>pz.</b>	€	€	€
<b>A20020 ...</b>	1	41,40	47,70	53,90

## A20060

Spandisapone da appoggio, con contenitore in vetro satinato ed erogatore in finitura  
 Tabletop soap dispenser with satined glass container and pump in finishing  
 Distributeur de savon à poser avec pot en verre satiné et doseur en finition  
 Dosificador de jabón líquido de apoyo con recipiente de vidrio satinado y dispensador en acabado

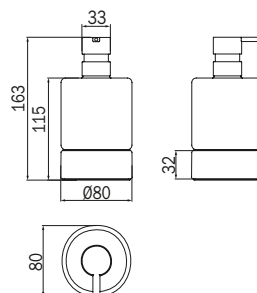

		CR 21	NE 21 WM 21	AC 21
<b>cod.</b>	<b>pz.</b>	€	€	€
<b>A20060 ...</b>	1	61,30	76,70	86,20

0,35 Lt.

## A2025B

Portarotolo  
 Paper holder  
 Porte-rouleau  
 Portarrollos

NEW

DX

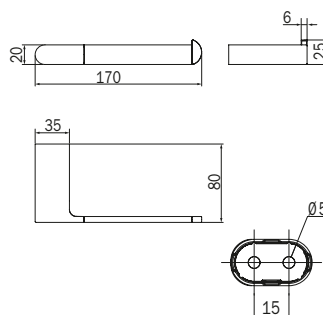

## A2025A

NEW

SX



		CR	NE WM	AC
<b>cod.</b>	<b>pz.</b>	€	€	€
<b>A2025A ...</b>	1	51,50	58,60	64,50
<b>A2025B ...</b>	1	51,50	58,60	64,50

click

**A20260**

NEW

Portarotolo basculante con coperchio  
 Tilting roll holder with cover  
 Porte-rouleau basculant avec couvercle  
 Portarrollos basculante con tapa

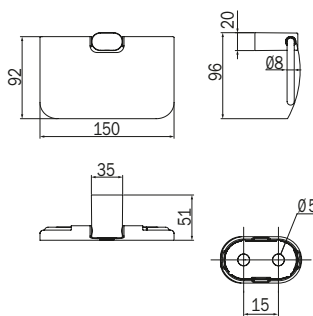

click

cod.	pz.			
		CR	NE WM	AC
		€	€	€
<b>A20260 ...</b>	1	81,30	93,60	105,80

**A2028A**

NEW

Portarotolo di scorta  
 Spare roll holder  
 Porte-rouleau réserve  
 Portarrollos de repuesto

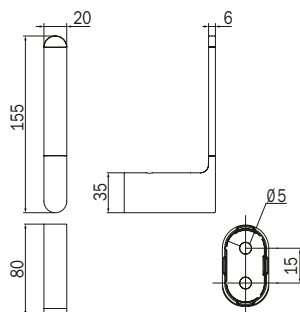

click

cod.	pz.			
		CR	NE WM	AC
		€	€	€
<b>A2028A ...</b>	1	51,50	58,60	64,50

**AV014A**

Portascopino da parete/da appoggio. Scovolo di ricambio bianco incluso  
 Wall mounted/free-standing toilet brush holder. White spare brush included  
 Porte-balai mural/à poser. Balayette de rechange blanche incluse  
 Escobillero de pared/de suelo. Escobilla de repuesto blanca incluida

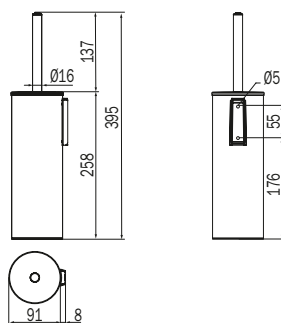

cod.	pz.	
		CR WM
		€
<b>AV014A ...</b>	1	100,80





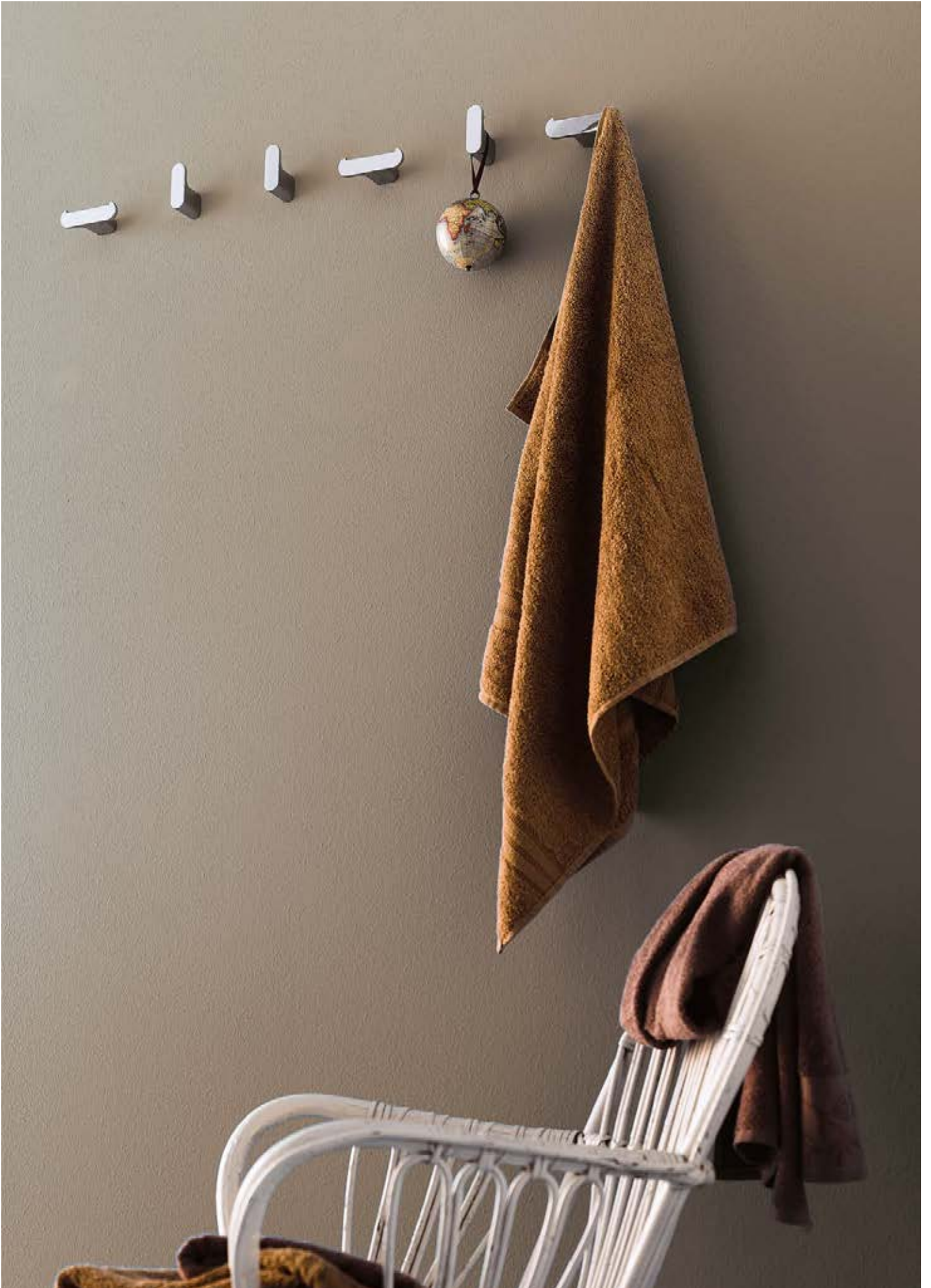

## DIVO\_1500

IT Divo è una serie di accessori dal carattere forte e deciso, espressione di un design pragmatico ed essenziale che si esprime attraverso linee pulite e squadrate. L'assenza della placca di fissaggio a muro diventa espressione di un gusto contemporaneo minimale che si esprime con un "segno" che caratterizza lo spazio.

EN Divo is a series of accessories with strong character, expression of a pragmatic and essential design that is expressed through clean and squared lines. The absence of the fixing plaque to the wall becomes an expression of a contemporary minimalist taste which is expressed by a "sign" that characterizes the space.

FR Divo est série d'accessoire au caractère fort et décidé, expression d'un design pragmatique et essentiel qui s'exprime par des lignes simples et carrées. L'absence de plaque de fixation devient une expression d'un goût contemporain minimal qui s'exprime avec un "signe" qui caractérise l'espace.

ES Divo es una serie de accesorios del carácter fuerte y decidido, expresión de un design pragmático y esencial que se refleja a través de líneas simples y cuadradas. La esencia de la placa de fijación al muro se vuelve expresión de un gusto contemporáneo minimal que se expresa con un 'signo' que caracteriza el espacio.

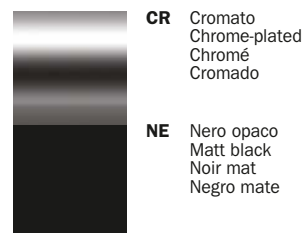

# DIVO









DIVO  
1500

## DIVO\_1500

**A1518**

NEW

Portasalviette  
Towel holder  
Porte-serviettes  
Toallero

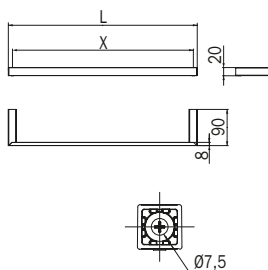

				CR	NE
cod.	L	X	pz.	€	€
A1518A ...	320	300	1	70,50	81,20
A1518B ...	470	450	1	78,10	90,00
A1518C ...	620	600	1	82,30	94,80
A1518D ...	820	800	1	86,70	99,70

**A15150**

NEW

Portasalviette doppio a snodo  
Double swing arm towel holder  
Porte-serviettes double mobile  
Toallero doble articulado

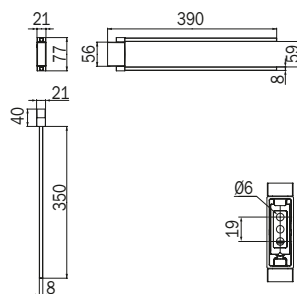

			CR	NE
cod.	pz.		€	€
A15150 ...	1		96,40	110,90

**A1520A**

NEW

Appendiabiti  
Clothes hanger  
Patère  
Percha

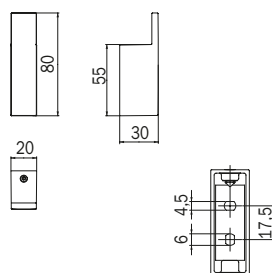

			CR	NE
cod.	pz.		€	€
A1520A ...	1		29,90	34,50

**A15120**

NEW

Spandisapone a parete con contenitore in vetro extrachiaro trasparente, erogatore in finitura  
 Wall-mounted soap dispenser with extra clear transparent glass container and in finish brass pump  
 Distributeur de savon mural avec pot en verre transparent extra clair, doseur en finition  
 Dosificador de jabón líquido de pared con recipiente de vidrio transparente extraclaro, dispensador en acabado

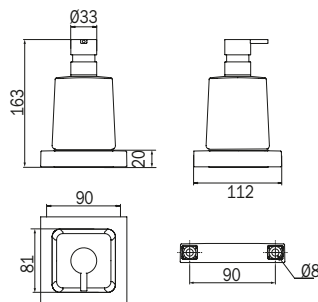

0,25 Lt.

cod.	pz.	CR 03 CR 21		NE 03 NE 21	
		€	€	€	€
<b>A15120 ...</b>	1	103,40	118,90		

**A15110**

NEW

Portasapone a parete con bacinella in vetro extrachiaro trasparente  
 Wall-mounted soap holder with extra clear transparent glass dish  
 Porte-savon mural avec coupelle en verre transparent extra clair  
 Jabonera de pared con cubeta de vidrio extraclaro transparente

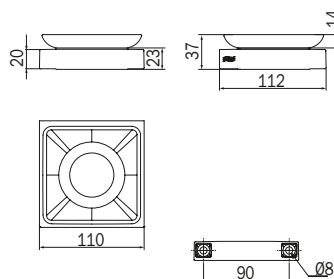

cod.	pz.	CR 03 CR 21		NE 03 NE 21	
		€	€	€	€
<b>A15110 ...</b>	1	73,40	84,50		

**A15100**

NEW

Portabicchiere a parete con bicchiere in vetro extrachiaro trasparente  
 Wall-mounted tumbler holder with extra clear transparent glass tumbler  
 Porte-verre mural avec verre en verre transparent extra clair  
 Portavasos de pared con vaso de vidrio extraclaro transparente

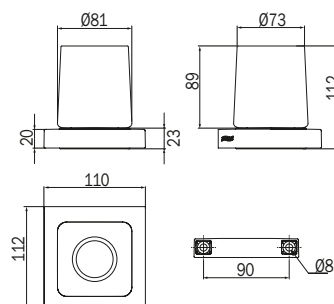

cod.	pz.	CR 03 CR 21		NE 03 NE 21	
		€	€	€	€
<b>A15100 ...</b>	1	73,40	84,50		

## DIVO\_1500

## A2012Z

NEW

Spandisapone da appoggio, con contenitore in vetro ed erogatore in finitura  
 Tabletop soap dispenser with glass container and pump in finishing  
 Distributeur de savon à poser avec pot en verre et doseur en finition  
 Dosificador de jabón líquido de apoyo con recipiente de vidrio y dispensador en acabado

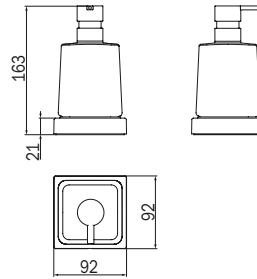

0,25 Lt.

cod.	pz.	CR 03 CR 21		NE 03 NE 21	
		€	€	€	€
A2012Z ...	1	79,20	89,30		

## A2010Z

NEW

Portabicchiere da appoggio con bicchiere in vetro  
 Tabletop tumbler holder with glass tumbler  
 Porte-verre à poser avec verre en verre  
 Portavasos de apoyo con vaso de vidrio

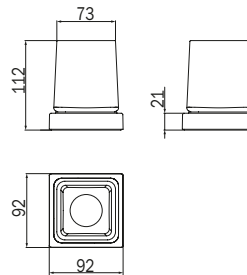

cod.	pz.	CR 03 CR 21		NE 03 NE 21	
		€	€	€	€
A2010Z ...	1	63,90	72,10		

## A2011Z

NEW

Portasapone da appoggio con bacinella in vetro  
 Tabletop soap holder with glass dish  
 Porte-savon à poser avec coupelle en verre  
 Jabonera de apoyo con cubeta de vidrio

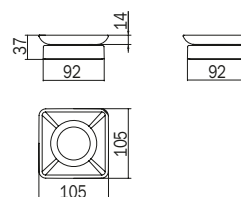

cod.	pz.	CR 03 CR 21		NE 03 NE 21	
		€	€	€	€
A2011Z ...	1	58,60	66,10		



**A1525B**

Portarotolo  
Paper holder  
Porte-rouleau  
Portarrollos

NEW

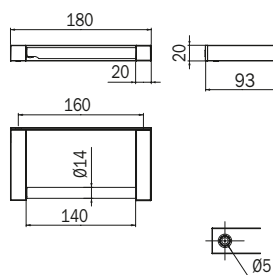

		CR	NE
cod.	pz.	€	€
A1525B ...	1	96,40	110,90

**A1527A**

Portarotolo con coperchio portacellulare  
Toilet roll holder with mobile phone holder  
Porte-rouleau avec support pour téléphone portable  
Portarrollos con tapa porta mòvil

NEW

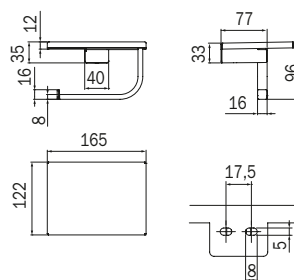

		CR	NE
cod.	pz.	€	€
A1527A ...	1	131,30	150,50

click

**A15490**

Cestino  
Basket  
Panier porte-savon  
Jabonera de rejilla

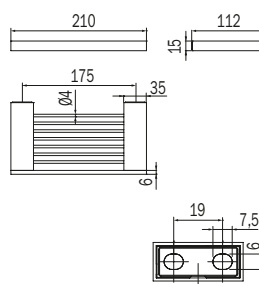

		CR
cod.	pz.	€
A15490 ...	1	84,50

## DIVO\_1500

### A15510

Cestino con ripiano asportabile  
Basket with removable shelf  
Panier porte-savon avec grille amovible  
Jabonera con bandeja deslizable

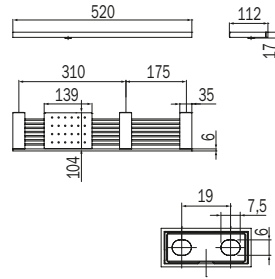

		CR	
cod.	pz.	€	
A15510 ...	1	171,00	

### A33850

NEW

Piantana con 2 portasalviette  
Stand with 2 towel holders  
Porte-serviettes sur pied avec 2 porte-serviettes  
Toallero de pie con 2 brazos

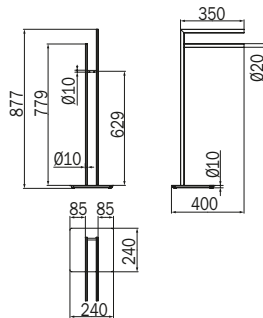

		CR		NE	
cod.	pz.	€		€	
A33850 ...	1	492,40		539,40	

### AV114A

Portascopino da parete/da appoggio  
Wall mounted/free-standing toilet brush holder  
Porte-balai mural/à poser  
Escobillero de pared/de suelo

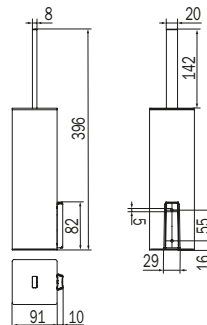

		CR	
cod.	pz.	€	
AV114A ...	1	177,90	



**AV114B**

NEW

Portascopino da parete/da appoggio  
 Wall mounted/free-standing toilet brush holder  
 Porte-balai mural/à poser  
 Escobillero de pared/de suelo

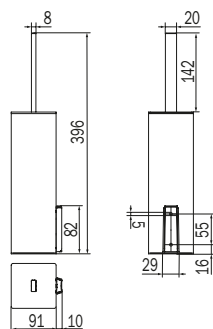

		CR	NE
cod.	pz.	€	€
AV114B ...	1	177,90	211,10

# LEA\_1800

**IT** Lea, funzionalità essenziale. Voglia di nuove geometrie con la purezza della forma a sezione rettangolare, un sistema completo di accessori che soddisfa, con proposte mirate, tutte le esigenze e le funzioni dell'arredobagno! La serie può essere montata a parete utilizzando il kit da incollo per evitare la foratura delle ceramiche oppure con viti e tasselli.

**EN** Lea, essential functionality. Desire for new geometries with the purity of a rectangular section form, a complete system of accessories that meets with specific proposals the needs and functions of bathroom design! The series can be wall-mounted using the glue from the kit to avoid drilling of ceramics or installed with screws and dowels.

**FR** Lea, fonctionnalité essentielle. Envie de nouvelles géométries ayant une forme pure à section rectangulaire, une gamme complète d'accessoires qui satisfait, avec une offre ciblée, toutes les exigences et toutes les fonctions d'une salle de bain! La série peut être montée au mur en utilisant la colle afin d'éviter de percer le carrelage ou bien avec des vis et chevilles.

**ES** Lea, funcionalidad esencial. Deseo de nuevas geometrías con la pureza de la forma a sección rectangular, un sistema completo de accesorios que satisface con propuestas específicas todas las necesidades y funciones del cuarto de baño! La serie puede ser montada a pared utilizando el kit adhesivo para evitar la perforación de la cerámica o puede ser instalada con tornillos y tacos.

	<b>CR</b> Cromato Chrome-plated Chromé Cromado
	<b>AC</b> Nickel spazzolato Brushed nickel Nickel brossé Níquel cepillado
	<b>CG</b> Cromo nero spazzolato Brushed black chrome Black chrome brossé Cromado negro cepillado
	<b>OR</b> Oro rosato lucido Glossy rose-coloured gilded Doré rosé brillant Cromado rosado brillante
	<b>DR</b> Dorato 24 carati Gilded 24 carats Doré 24 carats Dorado 24 quilates
	<b>BZ</b> Bronzo Bronzed Bronze Bronce
	<b>NE</b> Nero opaco Matt black Noir mat Negro mate
	<b>WM</b> Bianco opaco Matt white Blanc mat Blanco mate

# LEA













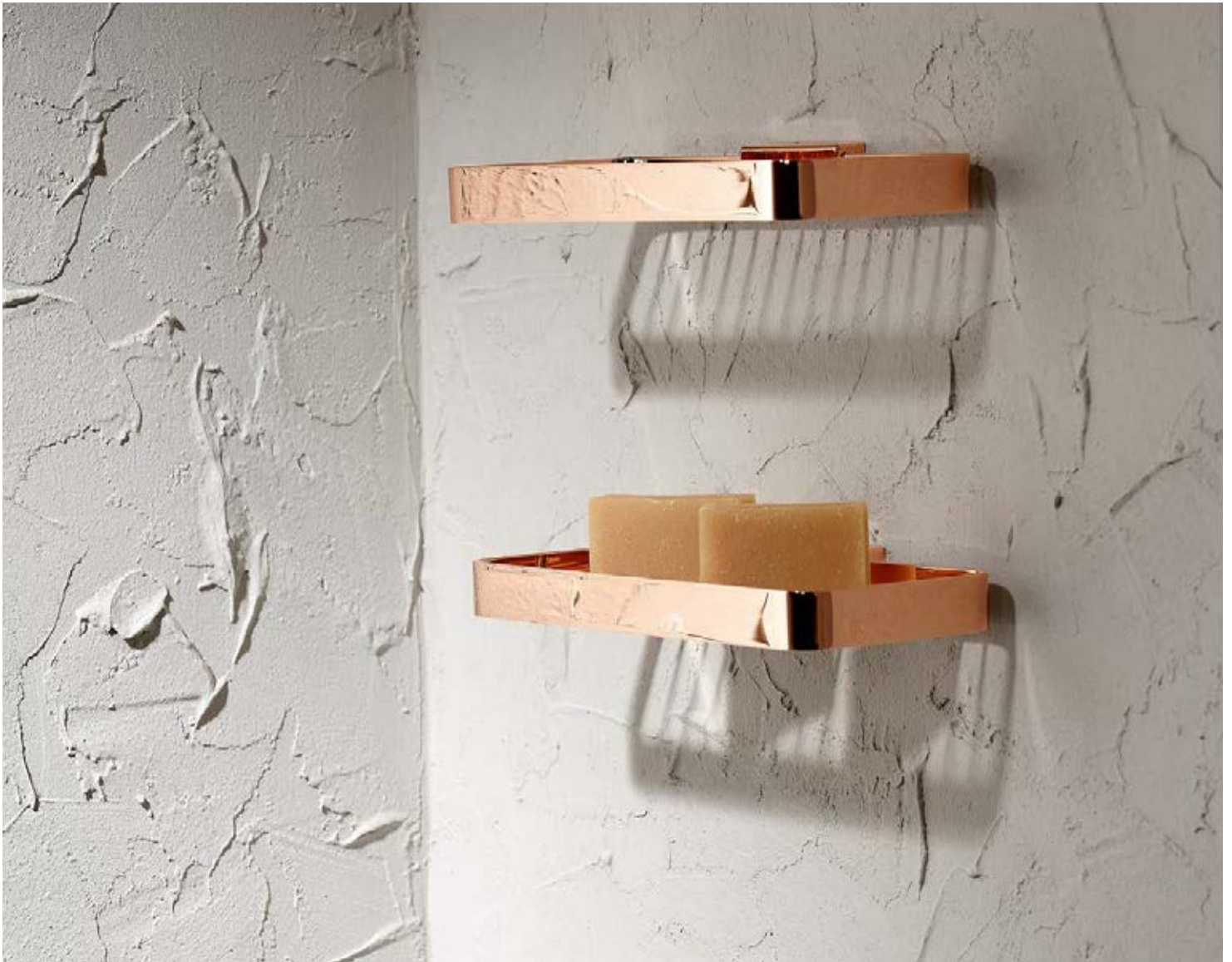

## LEA\_1800

## R1800N

NEW

Kit fissaggio a parete. Include confezione colla bicomponente a posa rapida. (kit opzionale)  
 Wall mounting kit. It includes one package of two-component adhesive for quick installation. (optional kit)  
 Kit de fixation murale. Comprend un set de colle à pose rapide à deux composants. (kit en option)  
 Kit fijación a pared opcional. Incluye pegamento bicomponente a instalación rápida

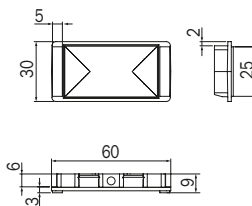

cod.	pz.	001 (CR)	006 (NE) 010 (WM)	007 (AC)	004 (CG) 008 (OR)	002 (BZ) 005 (DR)
		€	€	€	€	€
R1800N ...	1	15,10	17,40	21,20	27,20	24,00

## A1818

Portasalviette  
 Towel holder  
 Porte-serviettes  
 Toallero

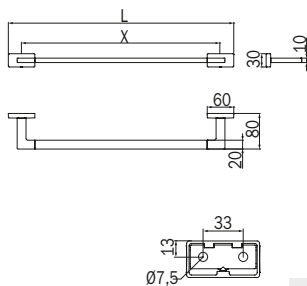

cod.	L	X	pz.	CR	NE WM	AC	BZ DR	CG OR
				€	€	€	€	€
A1818A ...	360	300	1	68,60	79,70	96,20	110,60	123,70
A1818B ...	510	450	1	83,00	96,10	116,30	133,00	149,50
A1818C ...	660	600	1	92,90	107,20	130,10	149,20	167,30
A1818D ...	860	800	1	111,70	129,30	156,50	179,00	201,10



## A1819

Portasalviette doppio  
 Double towel holder  
 Porte-serviettes double  
 Toallero doble

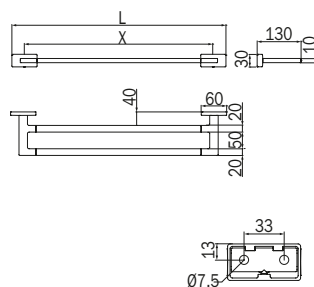
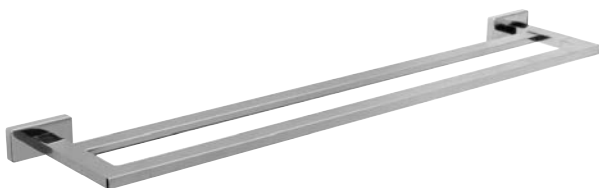

cod.	L	X	pz.	CR	NE WM	AC	BZ DR	CG OR
				€	€	€	€	€
A1819B ...	510	450	1	130,30	150,30	182,70	208,70	234,80
A1819C ...	660	600	1	144,90	166,90	203,00	231,90	260,90



**A1815**

Portasalviette fisso a bandiera  
Fixed towel holder  
Porte-serviettes fixe à drapeau  
Toallero fijo a bandera

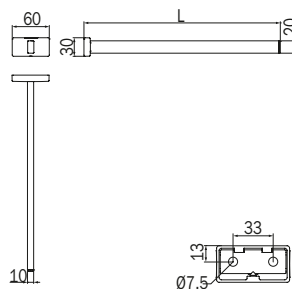

			CR	NE WM	AC	BZ DR	CG OR
<b>cod.</b>	<b>L</b>	<b>pz.</b>	€	€	€	€	€
<b>A18150 ...</b>	<b>448</b>	1	42,60	51,20	59,80	69,70	76,80
<b>A1815B ...</b>	<b>318</b>	1	39,10	47,60	55,40	64,10	70,40

**A1815A**

Portasalviette doppio a snodo  
Double swing arm towel holder  
Porte-serviettes double mobile  
Toallero doble articulado

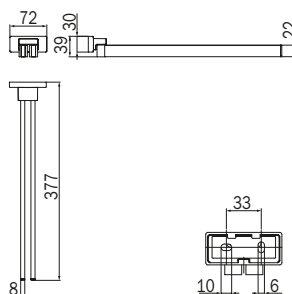

			CR
<b>cod.</b>	<b>L</b>	<b>pz.</b>	€
<b>A1815A ...</b>	<b>318</b>	1	103,90

**A18160**

Portasalviette ad anello  
Ring towel holder  
Porte-serviette anneau  
Toallero de aro

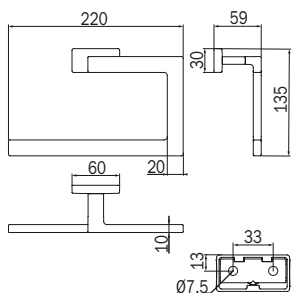

			CR	NE WM	AC	BZ DR	CG OR
<b>cod.</b>	<b>pz.</b>	€	€	€	€	€	€
<b>A18160 ...</b>	1	71,90	83,00	100,70	115,00	129,50	



## LEA\_1800

## A18680

Portateli con portasalviette  
Bath towel rack with towel holder  
Rack porte-serviettes  
Repisa con toallero

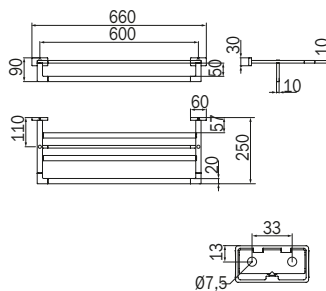

cod.	pz.	CR	NE	AC	BZ	CG
		€	WM	€	DR	OR
A18680 ...	1	231,90	267,20	324,90	371,00	417,70

## A1820A

Appendiabiti  
Clothes hanger  
Patère  
Percha

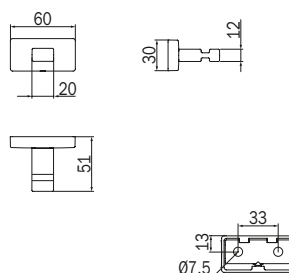

cod.	pz.	CR	NE	AC	BZ	CG
		€	WM	€	DR	OR
A1820A ...	1	17,70	20,20	24,80	28,20	31,90



## A1820B

Appendiabiti doppio  
Double clothes hanger  
Patère double  
Percha doble

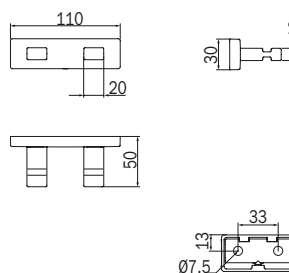

cod.	pz.	CR	NE	AC	BZ	CG
		€	WM	€	DR	OR
A1820B ...	1	25,40	29,20	35,60	40,50	45,70

**A1820C**

Appendiabiti triplo  
Triple clothes hanger  
Patère triple  
Percha triple

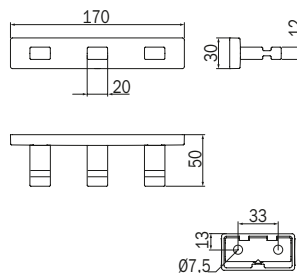

cod.	pz.	CR	NE WM	AC	BZ DR	CG OR
		€	€	€	€	€
<b>A1820C ...</b>	1	36,20	41,60	50,90	58,70	65,40

**A18670**

Spandisapone a leva a parete con contenitore in vetro satinato, leva in finitura  
Wall-mounted lever soap dispenser with satined glass container, lever in finish  
Distributeur de savon à levier mural avec récipient en verre dépoli, levier en finition  
Jabonera a palanca para pared con contenedor en cristal satinado, palanca en acabado

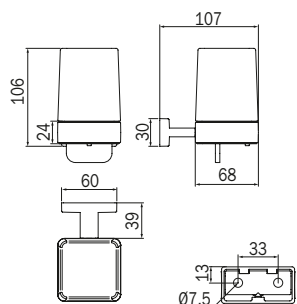

cod.	pz.	CR 21	NE 21 WM 21	AC 21	BZ 21 DR 21	CG 21 OR 21
		€	€	€	€	€
<b>A18670 ...</b>	1	64,90	74,80	91,10	104,00	117,00

0,18 Lt.

**A18120**

Spandisapone a parete con contenitore in vetro satinato, erogatore in finitura  
Wall-mounted soap dispenser with satined glass container and in finish brass pump  
Distributeur de savon mural avec pot en verre satiné, doseur en finition  
Dosificador de jabón líquido de pared con recipiente de vidrio satinado, dispensador en acabado

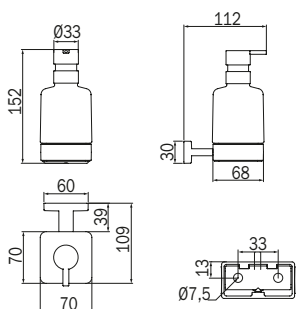

cod.	pz.	CR 21	NE 21 WM 21	AC 21	BZ 21 DR 21	CG 21 OR 21
		€	€	€	€	€
<b>A18120 ...</b>	1	56,60	65,20	79,20	90,70	101,90

0,25 Lt.

## LEA\_1800

## A18100

Portabicchiere a parete con bicchiere in vetro satinato  
 Wall-mounted tumbler holder with satined glass tumbler  
 Porte-verre mural avec verre en verre satiné  
 Portavasos de pared con vaso de vidrio satinado

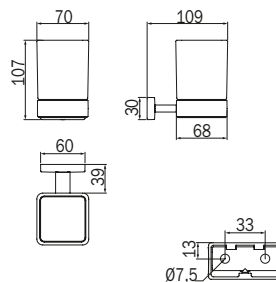

cod.	pz.	CR 21	NE 21	AC 21	BZ 21	CG 21
		€	WM 21	€	DR 21	OR 21
A18100 ...	1	40,80	47,00	57,20	65,20	73,60

## A18110

Portasapone a parete con bacinella in vetro satinato  
 Wall-mounted soap holder with satined glass dish  
 Porte-savon mural avec coupelle en verre satiné  
 Jabonera de pared con cubeta de vidrio satinado

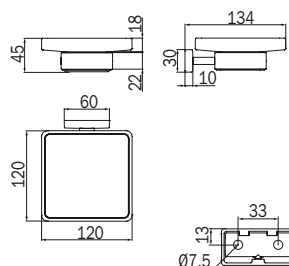

cod.	pz.	CR 21	NE 21	AC 21	BZ 21	CG 21
		€	WM 21	€	DR 21	OR 21
A18110 ...	1	40,80	47,00	57,20	65,20	73,60

## A1810D

Supporto doppio a parete con bicchiere e spandisapone in vetro satinato, erogatore in finitura  
 Wall-mounted double support with satined glass tumbler and soap dispense in finish brass pump  
 Support double mural avec verre et distributeur de savon en verre satiné doseur en finition  
 Soporte de pared doblo con vaso y dosificador de jabón líquido de vidrio satinado, dispensador en acabado

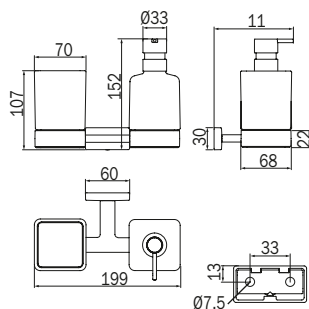

0,25 Lt.

cod.	pz.	CR 21	NE 21	AC 21	BZ 21	CG 21
		€	WM 21	€	DR 21	OR 21
A1810D ...	1	79,70	91,80	111,70	128,20	143,60

**A1810F**

Portabicchiere a parete con 2 bicchieri in vetro satinato  
 Wall-mounted tumbler holder with 2 satined glass tumblers  
 Porte-verre mural avec 2 verres en verre satiné  
 Portavasos de pared con 2 vasos de vidrio satinado

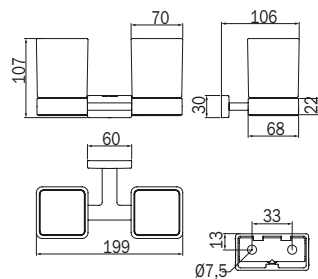

cod.	pz.	CR 21	NE 21	AC 21	BZ 21	CG 21
		€	WM 21	€	DR 21	OR 21
<b>A1810F ...</b>	1	64,10	74,10	89,80	102,80	115,50

**A1812Z**

Spandisapone da appoggio, con contenitore in vetro satinato ed erogatore in finitura  
 Tabletop soap dispenser with satined glass container and pump in finishing  
 Distributeur de savon à poser avec pot en verre satiné et doseur en finition  
 Dosificador de jabón líquido de apoyo con recipiente de vidrio satinado y dispensador en acabado

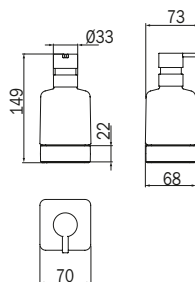

cod.	pz.	CR 21	NE 21	AC 21	BZ 21	CG 21
		€	WM 21	€	DR 21	OR 21
<b>A1812Z ...</b>	1	43,30	49,90	60,80	69,70	78,10

0,25 Lt.

**A1810Z**

Portabicchiere da appoggio con bicchiere in vetro satinato  
 Tabletop tumbler holder with satined glass tumbler  
 Porte-verre à poser, avec verre en verre satiné  
 Portavasos de apoyo con vaso de vidrio satinado

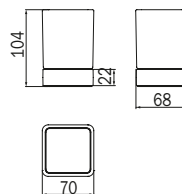

cod.	pz.	CR 21	NE 21	AC 21	BZ 21	CG 21
		€	WM 21	€	DR 21	OR 21
<b>A1810Z ...</b>	1	28,60	32,80	40,10	45,80	51,60

## LEA\_1800

**A1811Z**

Portasapone da appoggio con bacinella in vetro satinato  
 Tabletop soap holder with satined glass dish  
 Porte-savon à poser, avec coupelle en verre satiné  
 Jabonera de apoyo con cubeta de vidrio satinado

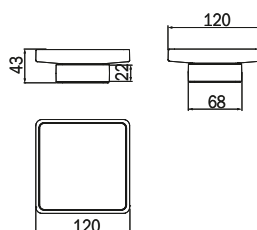

		CR 21	NE 21 WM 21	AC 21	BZ 21 DR 21	CG 21 OR 21
<b>cod.</b>	<b>pz.</b>	€	€	€	€	€
<b>A1811Z ...</b>	1	28,60	32,80	40,10	45,80	51,60

**A18250**

SX

Portarotolo  
 Paper holder  
 Porte-rouleau  
 Portarrollos

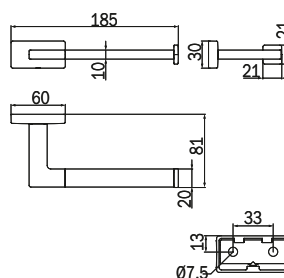
**A1825A**

DX



		CR	NE WM	AC	BZ DR	CG OR
<b>cod.</b>	<b>pz.</b>	€	€	€	€	€
<b>A18250 ...</b>	1	43,30	49,90	60,80	69,70	78,10
<b>A1825A ...</b>	1	43,30	49,90	60,80	69,70	78,10

**A1825B**

Portarotolo doppio  
 Double paper holder  
 Porte-rouleau double  
 Portarrollos doble

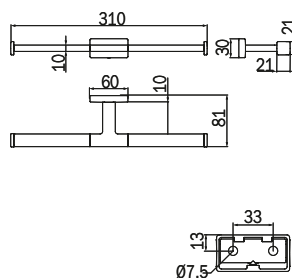
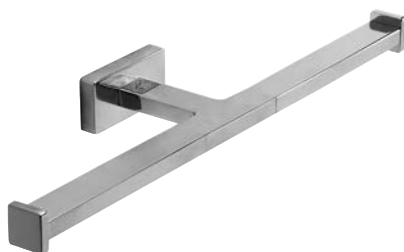

		CR	NE WM	AC	BZ DR	CG OR
<b>cod.</b>	<b>pz.</b>	€	€	€	€	€
<b>A1825B ...</b>	1	64,10	74,10	89,80	102,80	115,50





**A18260**

Portarotolo basculante con coperchio  
 Tilting roll holder with cover  
 Porte-rouleau basculant avec couvercle  
 Portarrollos basculante con tapa

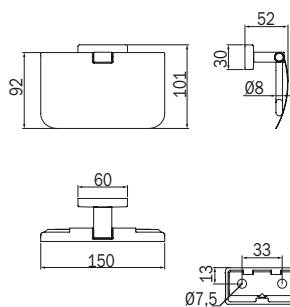

cod.	pz.	CR	NE WM	AC	BZ DR	CG OR
		€	€	€	€	€
<b>A18260 ...</b>	1	56,60	65,20	79,20	90,70	101,90

**A1826A**

Portarotolo con coperchio  
 Paper holder with cover  
 Porte-rouleau avec couvercle  
 Portarrollos con tapa

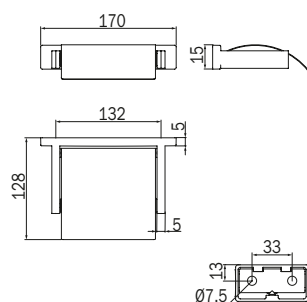

cod.	pz.	CR	NE WM	AC	BZ DR	CG OR
		€	€	€	€	€
<b>A1826A ...</b>	1	76,30	88,40	106,80	122,70	137,30

**A18280**

Portarotolo di scorta  
 Reserve paper holder  
 Porte-rouleau de réserve  
 Portarrollos de repuesto

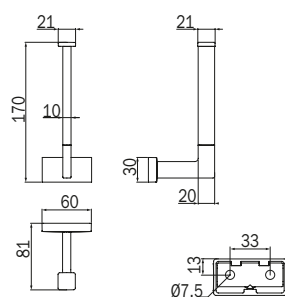

cod.	pz.	CR	NE WM	AC	BZ DR	CG OR
		€	€	€	€	€
<b>A18280 ...</b>	1	38,60	44,30	54,10	62,10	69,50

## LEA\_1800

## A18310

Angolare  
Corner  
Porte-objets d'angle  
Jabonera angular

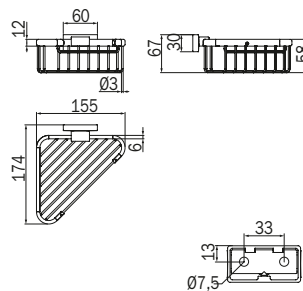

cod.	pz.	CR	NE WM	AC	BZ DR	CG OR
		€	€	€	€	€
A18310 ...	1	60,90	70,80	85,40	97,30	109,70

## A18510

Cestino  
Basket  
Panier porte-savon  
Jabonera de rejilla

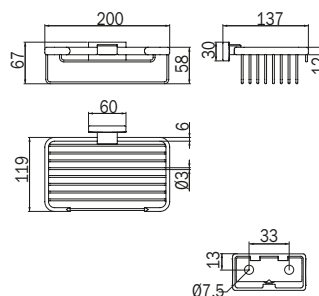

cod.	pz.	CR	NE WM	AC	BZ DR	CG OR
		€	€	€	€	€
A18510 ...	1	69,70	80,80	97,60	111,70	125,50

## A1849A

Cestino  
Basket  
Panier porte-savon  
Jabonera de rejilla

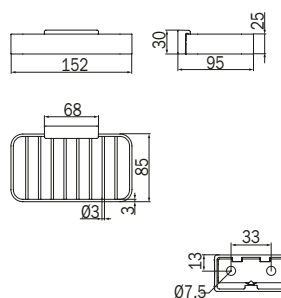

cod.	pz.	CR	NE WM	AC	BZ DR	CG OR
		€	€	€	€	€
A1849A ...	1	59,80	69,70	83,80	96,10	107,70

**A1851A**

Cestino  
Basket  
Panier porte-savon  
Jabonera de rejilla

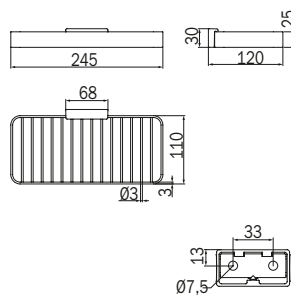

		CR	NE WM	AC	BZ DR	CG OR
<b>cod.</b>	<b>pz.</b>	€	€	€	€	€
<b>A1851A ...</b>	1	84,10	97,30	117,90	134,90	151,50

**A1895**

NEW

Maniglione di sicurezza  
Safety grip  
Barre d'appui de sécurité  
Manillón de seguridad

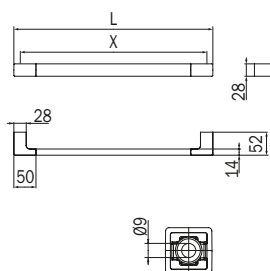

				CR	NE WM	AC	BZ DR	CG OR
<b>cod.</b>	<b>L</b>	<b>X</b>	<b>pz.</b>	€	€	€	€	€
<b>A1895A ...</b>	<b>300</b>	<b>272</b>	1	96,40	110,90	135,00	154,30	173,60
<b>A1895B ...</b>	<b>450</b>	<b>422</b>	1	103,00	118,40	144,20	164,80	185,40
<b>A1895C ...</b>	<b>600</b>	<b>572</b>	1	110,60	127,30	154,90	177,00	199,10

1.500N  
-150Kg**A18090**

Mensola in cristallo satinato temperato 6 mm con supporti  
Tempered satined crystal shelf, 6 mm glass, with brackets  
Tablette en cristal satiné trempé 6 mm, avec supports  
Repisa de cristal sat. templado es.vidrio 6 mm con soportes

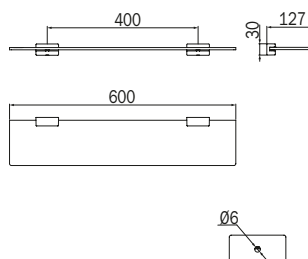

		CR 21	NE 21 WM 21	AC 21	BZ 21 DR 21	CG 21 OR 21
<b>cod.</b>	<b>pz.</b>	€	€	€	€	€
<b>A18090 ...</b>	1	77,40	89,70	108,50	123,90	139,50

## LEA\_1800

## A18140

Portascopino da parete con bacinella in vetro satinato - scovolo bianco  
 Wall-mounted toilet brush holder, with satined glass dish - white brush  
 Porte-balai mural avec coupelle en verre satiné - brosse blanche  
 Escobillero de pared con cubeta de vidrio satinado - escobilla blanca

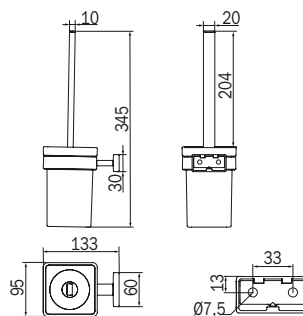

		CR 21	WM 21	AC 21	BZ 21 DR 21	OR 21
cod.	pz.	€	€	€	€	€
A18140 ...	1	83,00	96,10	116,30	132,60	149,50

## A1814B

NEW

Portascopino da parete con bacinella in vetro satinato - scovolo nero  
 Wall-mounted toilet brush holder, with satined glass dish - black brush  
 Porte-balai mural avec coupelle en verre satiné - brosse noir  
 Escobillero de pared con cubeta de vidrio satinado - escobilla negra

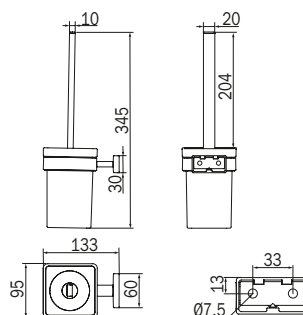

		NE 21	CG 21
cod.	pz.	€	€
A1814B ...	1	96,10	149,50



# ONE\_2400

**IT** La semplicità ha un nuovo nome: One. La collezione di accessori per il bagno disegnata da Matteo Thun e Antonio Rodriguez combina elementi lineari e puliti. La vastità dell'assortimento e la chiarezza formale rendono One una soluzione particolarmente flessibile sia dal punto di vista stilistico che pratico. La collezione One si adatta sia ad ambienti pubblici che residenziali.

**EN** Simplicity has a new name: One. The collection of bathroom accessories designed by Matteo Thun and Antonio Rodriguez combines linear and clean elements. The vastness of the assortment and formal clarity make One a very flexible solution from the point of view of style and practicality. The One collection is suitable for both commercial and residential environments.

**FR** La simplicité a un nouveau nom : One. La collection d'accessoires pour la salle de bains dessinée par Matteo Thun et Antonio Rodriguez, mélange des éléments linéaires et simples. L'étendue de l'assortiment et la clarté formelle rendent One une solution particulièrement flexible aussi bien au niveau du style que de la commodité. La collection One s'adapte soit à des lieux publics que résidentiels.

**ES** La sencillez tiene un nuevo nombre: One. La colección de accesorios para el baño diseñada por Matteo Thun y Antonio Rodriguez combinan elementos lineares y simples. La vasta selección y la claridad de las formas hace de One una solución particularmente flexible del punto de vista estilístico y práctico. La colección One se adapta sea a ambientes públicos que a residenciales.

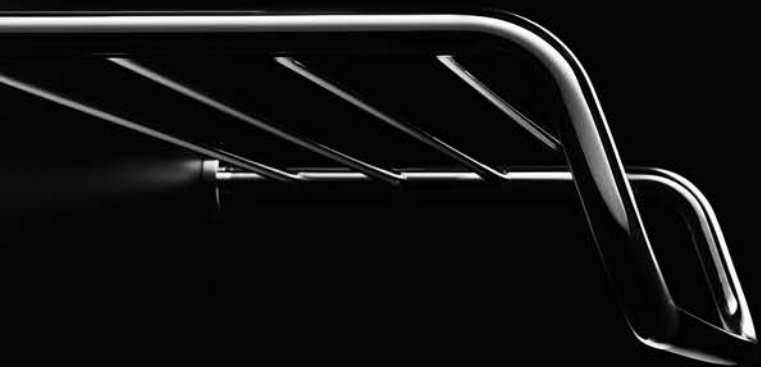

# ONE

	<b>CR</b> Cromato Chrome-plated Chromé Cromado
	<b>AC</b> Nickel spazzolato Brushed nickel Nickel brossé Níquel cepillado
	<b>CG</b> Cromo nero spazzolato Brushed black chrome Black chrome brossé Cromado negro cepillado
	<b>OR</b> Oro rosato lucido Glossy rose-coloured gilded Doré rosé brillant Cromado rosado brillante
	<b>DR</b> Dorato 24 carati Gilded 24 carats Doré 24 carats Dorado 24 quilates
	<b>BZ</b> Bronzo Bronzed Bronze Bronce
	<b>NE</b> Nero opaco Matt black Noir mat Negro mate
	<b>WM</b> Bianco opaco Matt white Blanc mat Blanco mate











## ONE\_2400

## A2490

Portasalviette  
Towel holder  
Porte-serviettes  
Toallero

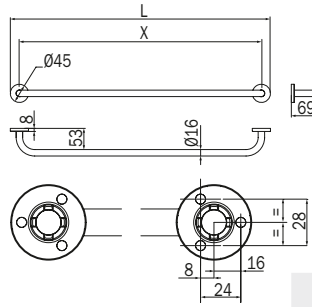

cod.	L	X	pz.	CR	NE	WM	AC	BZ	DR	CG	OR
				€	€	€	€	€	€		
A2490A ...	345	300	1	40,60	46,80	56,90	65,00	73,20			
A2490B ...	495	450	1	44,20	50,80	62,10	71,50	79,70			
A2490C ...	645	600	1	48,80	56,50	68,40	78,10	87,90			
A2490D ...	845	800	1	60,70	70,50	85,10	97,50	109,30			

## A2491C

Portasalviette doppio  
Double towel holder  
Porte-serviettes double  
Toallero doble

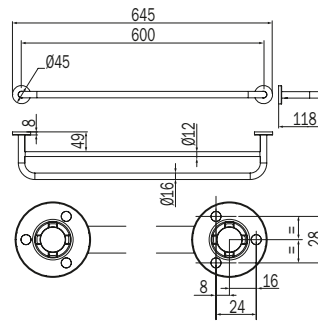

cod.	L	X	pz.	CR	NE	WM	AC	BZ	DR	CG	OR
				€	€	€	€	€	€		
A2491C ...	645	600	1	93,20	107,20	130,60	149,40	167,90			

## A2415A

Portasalviette fisso a bandiera  
Fixed towel holder  
Porte-serviettes fixe à drapeau  
Toallero fijo a bandera

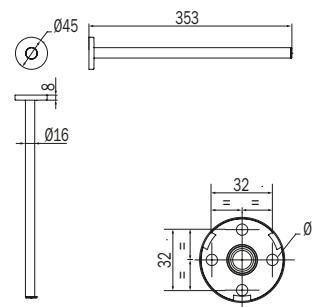

cod.	pz.	CR	NE	WM	AC	BZ	DR	CG	OR
		€	€	€	€	€	€	€	
A2415A ...	1	35,10	40,20	49,10	56,50	63,20			

**A2415B**

Portasalviette doppio a snodo  
 Double swing arm towel holder  
 Porte-serviettes double mobile  
 Toallero doble articulado

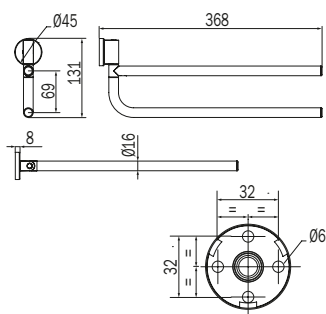

		CR	NE WM	AC	BZ DR	CG OR
cod.	pz.	€	€	€	€	€
<b>A2415B ...</b>	1	107,20	123,50	150,10	172,20	193,00

**A2416A**

Portasalviette ad anello  
 Ring towel holder  
 Porte-serviette anneau  
 Toallero de aro

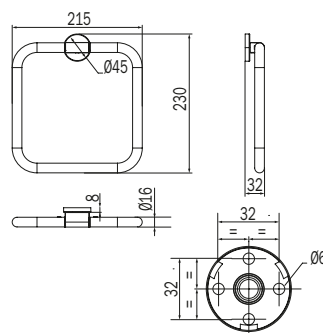

		CR	NE WM	AC	BZ DR	CG OR
cod.	pz.	€	€	€	€	€
<b>A2416A ...</b>	1	106,10	122,40	148,70	170,00	191,10

**A24680**

Portateli con portasalviette  
 Bath towel rack with towel holder  
 Rack porte-serviettes  
 Repisa con toallero

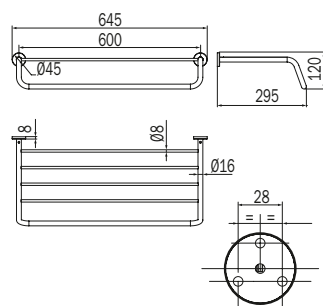

		CR	NE WM	AC	BZ DR	CG OR
cod.	pz.	€	€	€	€	€
<b>A24680 ...</b>	1	223,00	256,50	312,40	357,20	401,70

## ONE\_2400

## AV120A

Appendiabiti  
Clothes hanger  
Patère  
Percha

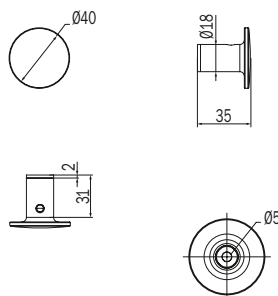

click

cod.	pz.	CR	NE	WM	AC	BZ	DR	CG	OR
		€	€	€	€	€	€		
AV120A ...	1	24,60	28,20	34,50	39,10	44,30			

## AV120E

Appendiabiti doppio  
Double clothes hanger  
Patère double  
Percha doble

NEW

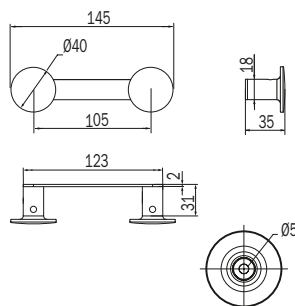

click

cod.	pz.	CR	NE	WM	AC	BZ	DR	CG	OR
		€	€	€	€	€	€	€	
AV120E ...	1	55,60	64,00	77,80	88,90	100,00			

## AV120B

Appendiabiti doppio  
Double clothes hanger  
Patère double  
Percha doble

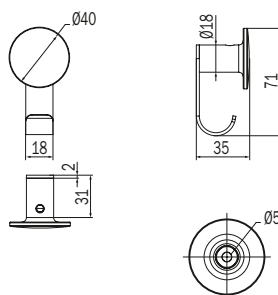

click

cod.	pz.	CR	NE	WM	AC	BZ	DR	CG	OR
		€	€	€	€	€	€	€	
AV120B ...	1	33,00	38,00	46,30	56,50	59,50			

**AV120C**

Appendiabiti triplo  
Triple clothes hanger  
Patère triple  
Percha triple

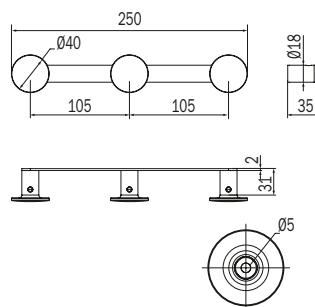

click

cod.	pz.	CR	NE WM	AC	BZ DR	CG OR
		€	€	€	€	€
<b>AV120C ...</b>	1	56,50	65,00	79,10	93,20	101,80

**AV120D**

Appendiabiti quadruplo  
Quadruple clothes hanger  
Patère quadruple  
Percha cuádruple

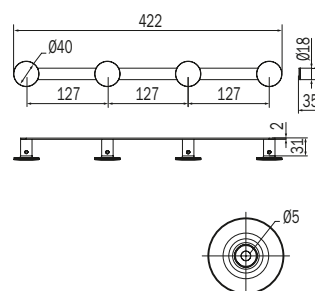
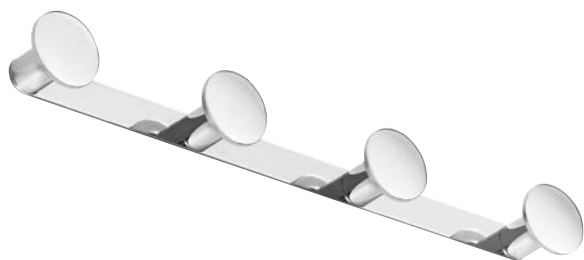

click

cod.	pz.	CR	NE WM	AC	BZ DR	CG OR
		€	€	€	€	€
<b>AV120D ...</b>	1	81,30	94,30	113,90	129,90	146,40

**A24120**

Spandisapone a parete con contenitore in vetro extrachiaro trasparente, erogatore in finitura  
Wall-mounted soap dispenser with extra clear transparent glass container and in finish brass pump  
Distributeur de savon mural avec pot en verre transparent extra clair, doseur en finition  
Dosificador de jabón líquido de pared con recipiente de vidrio transparente extraclaro, dispensador en acabado

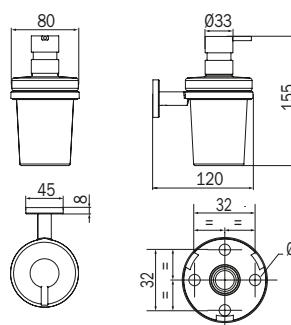

0,25 Lt.

cod.	pz.	CR 03	NE 03 WM 03	AC 03	BZ 03 DR 03	CG 03 OR 03
		€	€	€	€	€
<b>A24120 ...</b>	1	78,10	90,00	109,50	125,60	140,80

## ONE\_2400

## A2410A

Portabicchiere a parete con bicchiere in vetro extrachiari trasparente  
 Wall-mounted tumbler holder with extra clear transparent glass tumbler  
 Porte-verre mural avec verre en verre transparent extra clair  
 Portavasos de pared con vaso de vidrio transparente extraclaro

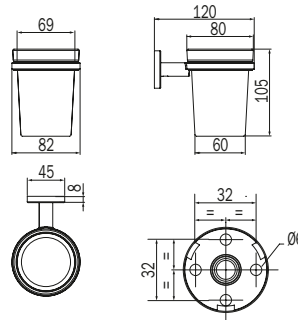

cod.	pz.	CR 03	NE 03	AC 03	BZ 03	CG 03
		€	WM 03	€	DR 03	OR 03
A2410A ...	1	61,80	71,50	86,60	99,80	111,40

## A24110

Portasapone a parete con bacinella in vetro extrachiari trasparente  
 Wall-mounted soap holder with extra clear transparent glass dish  
 Porte-savon mural avec coupelle en verre transparent extra clair  
 Jabonera de pared con cubeta de vidrio transparente extraclaro

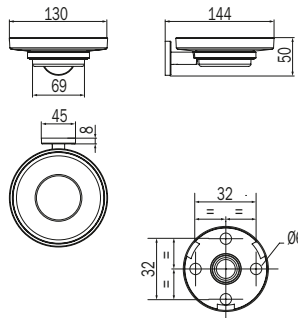

cod.	pz.	CR 03	NE 03	AC 03	BZ 03	CG 03
		€	WM 03	€	DR 03	OR 03
A24110 ...	1	61,80	71,50	86,60	99,80	111,40

## A24250

Portarotolo  
 Paper holder  
 Porte-rouleau  
 Portarrollos

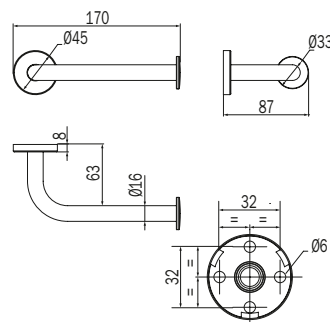

cod.	pz.	CR	NE	AC	BZ	CG
		€	WM	€	DR	OR
A24250 ...	1	53,30	61,80	74,80	85,50	96,10

**A2425C**

NEW

Portarotolo doppio  
Double paper holder  
Porte-rouleau double  
Portarrollos doble

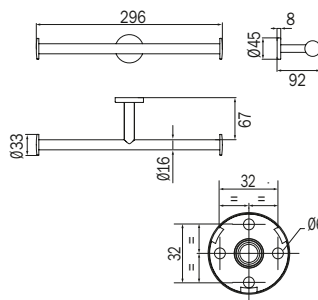

		CR	NE WM	AC	BZ DR	CG OR
<b>cod.</b>	<b>pz.</b>	€	€	€	€	€
<b>A2425C ...</b>	1	75,60	87,00	105,90	120,90	136,10

**A2426B**

NEW

Portarotolo con coperchio  
Paper holder with cover  
Porte-rouleau avec couvercle  
Portarrollos con tapa

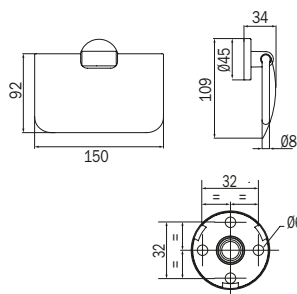

		CR	NE WM	AC	BZ DR	CG OR
<b>cod.</b>	<b>pz.</b>	€	€	€	€	€
<b>A2426B ...</b>	1	66,70	82,50	93,40	106,70	120,00

**A24260**

Portarotolo con coperchio  
Paper holder with cover  
Porte-rouleau avec couvercle  
Portarrollos con tapa

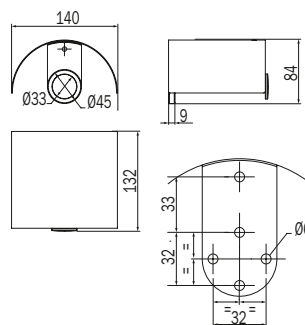

		CR	NE WM	AC	BZ DR	CG OR
<b>cod.</b>	<b>pz.</b>	€	€	€	€	€
<b>A24260 ...</b>	1	98,60	113,80	138,20	158,10	177,70

## ONE\_2400

## A24280

Portarotolo di scorta  
Spare roll holder  
Porte-rouleau réserve  
Portarollos de repuesto

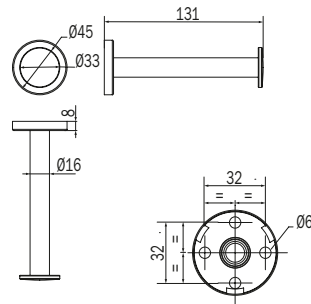

		CR	NE WM	AC	BZ DR	CG OR
cod.	pz.	€	€	€	€	€
A24280 ...	1	39,50	45,50	55,40	63,90	71,20

## A13950

Maniglione di sicurezza  
Safety grip  
Barre d'appui de sécurité  
Manillón de seguridad

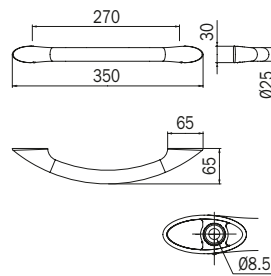

				CR
cod.	L	X	pz.	€
A13950 ...	350	270	1	66,20



1.500N  
~150Kg

## A1390

Maniglione di sicurezza  
Safety grip  
Barre d'appui de sécurité  
Manillón de seguridad

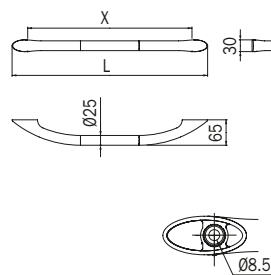

				CR
cod.	L	X	pz.	€
A1390B ...	500	420	1	67,90
A1390C ...	650	570	1	69,40



1.200N  
~120Kg



**AV014A**

Portascopino da parete/da appoggio. Scovolo di ricambio bianco incluso  
 Wall mounted/free-standing toilet brush holder. White spare brush included  
 Porte-balai mural/à poser. Balayette de rechange blanche incluse  
 Escobillero de pared/de suelo. Escobilla de repuesto blanca incluida

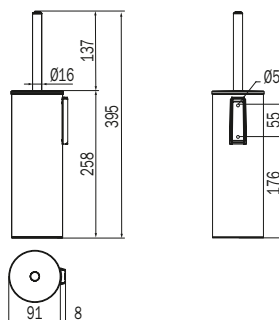

cod.	pz.	CR	BZ	DR
		WM	OR	
		€	€	€
AV014A ...	1	100,80	161,90	196,20

**AV014B**

Portascopino da parete/da appoggio. Scovolo di ricambio grigio incluso  
 Wall mounted/free-standing toilet brush holder. Grey spare brush included  
 Porte-balai mural/à poser. Balayette de rechange grise incluse  
 Escobillero de pared/de suelo. Escobilla de repuesto gris incluida

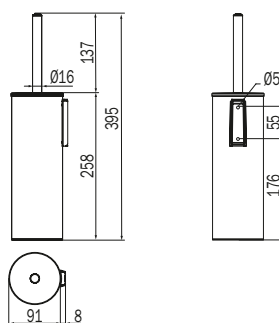

cod.	pz.	CR	AC
		NE	CG
		€	€
AV014B ...	1	100,80	116,90

## TOUCH\_4600

IT Touch: una gamma pensata per offrire un'ampia scelta sia in fatto di servizio che di tipologia compositiva, una gamma particolarmente articolata per una serie completa di accessori bagno.

EN Touch: a range designed to offer a large selection choice both in terms of service and composition type, a range particularly articulated to a complete range of bathroom accessories.

FR Touch: Une gamme pensée pour offrir un vaste choix soit en matière de service que de typologie de composition, particulièrement articulée pour une série complète d'accessoires de salle de bains.

ES Una gama especialmente articulada para una serie completa de accesorios para el baño: es Touch una colección ideada para ofrecer un amplio abanico de posibilidades tanto en lo que se refiere a las funciones como a los tipos de composición.



**CR** Cromato  
 Chrome-plated  
 Chromé  
 Cromado

# TOUCH









## TOUCH\_4600

**A4618A**

Portasalviette  
Towel holder  
Porte-serviettes  
Toallero

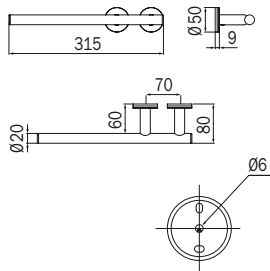

		CR
cod.	pz.	€
A4618A ...	1	106,10

**A4618**

Portasalviette  
Towel holder  
Porte-serviettes  
Toallero

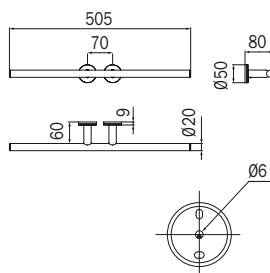

				CR
cod.	L	X	pz.	€
A4618B ...	505	70	1	117,00
A4618C ...	655	70	1	126,70

**A4618**

Portasalviette  
Towel holder  
Porte-serviettes  
Toallero

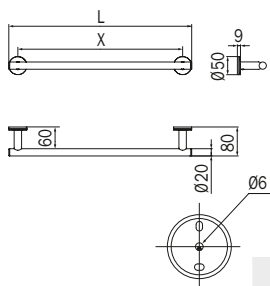

				CR
cod.	L	X	pz.	€
A4618E ...	315	265	1	106,10
A4618F ...	505	455	1	117,00
A4618G ...	655	605	1	126,70
A4618L ...	805	755	1	136,40

**A4618J**

Portasalviette interno ed esterno per parete doccia  
Internal and external towel holder for shower enclosure  
Porte-serviette intérieur et extérieur pour parois de douche  
Toallero interior y exterior para paredes de ducha

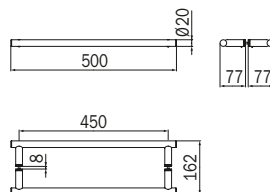

		CR
cod.	pz.	€
A4618J ...	1	125,60

**A4618K**

Portasalviette esterno per pareti doccia  
External towel holder for shower enclosure  
Porte-serviette extérieur pour parois de douche  
Toallero exterior para paredes de ducha

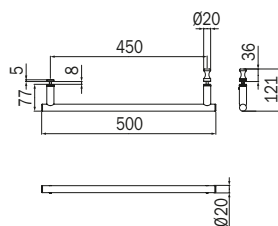

		CR
cod.	pz.	€
A4618K ...	1	85,50

**A4618U**

Portasalviette per pareti in vetro o mobili  
Towel holder for glass walls or furniture  
Porte-serviettes pour parois en verre ou meubles  
Toallero para paredes de vidrio o muebles

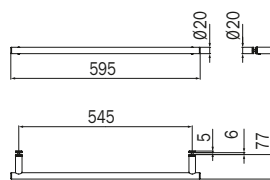

		CR
cod.	pz.	€
A4618U ...	1	128,90

## TOUCH\_4600

**A46150**

Portasalviette doppio a snodo  
 Double swing arm towel holder  
 Porte-serviettes double mobile  
 Toallero doble articulado

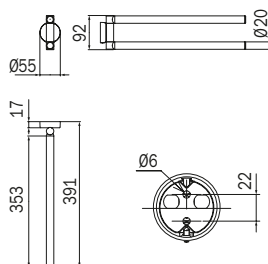

		CR
cod.	pz.	€
<b>A46150 ...</b>	1	170,00

**A46160**

Portasalviette ad anello  
 Ring towel holder  
 Porte-serviette anneau  
 Toallero de aro

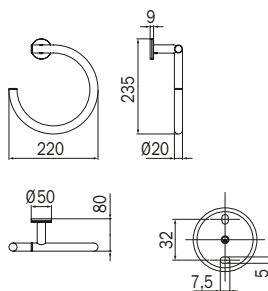

		CR
cod.	pz.	€
<b>A46160 ...</b>	1	91,00

**A46200**

Appendiabiti  
 Clothes hanger  
 Patère  
 Percha

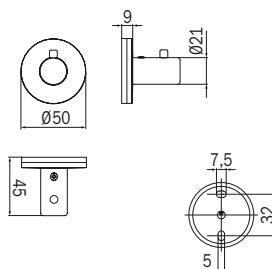

		CR
cod.	pz.	€
<b>A46200 ...</b>	1	44,00



**A46210**

Appendiabiti doppio  
Double clothes hanger  
Patère double  
Percha doble

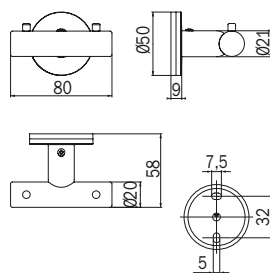

		CR
cod.	pz.	€
<b>A46210 ...</b>	1	58,60

**A46670**

Spandisapone a parete con contenitore in vetro satinato, erogatore in ottone cromato  
Wall-mounted soap dispenser with satinated glass container and chrome-plated brass pump  
Distributeur de savon mural avec pot en verre satiné, doseur en laiton chromé  
Dosificador de jabón líquido de pared con recipiente de vidrio satinado, dispensador en latón cromado

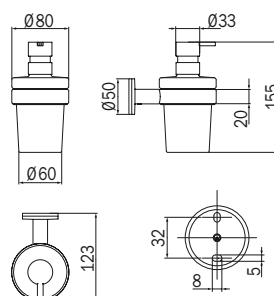

		CR 21
cod.	pz.	€
<b>A46670 ...</b>	1	153,80

0,25 Lt.

**A46100**

Portabicchiere a parete con bicchiere in vetro satinato  
Wall-mounted tumbler holder with satinated glass tumbler  
Porte-verre mural avec verre en verre satiné  
Portavasos de pared con vaso de vidrio satinado

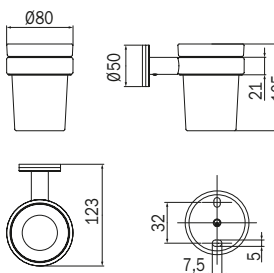

		CR 21
cod.	pz.	€
<b>A46100 ...</b>	1	106,10

## TOUCH\_4600

## A46110

Portasapone a parete con bacinella in vetro satinato  
 Wall-mounted soap holder with satinized glass dish  
 Porte-savon mural avec coupelle en verre satiné  
 Jabonera de pared con cubeta de vidrio satinado

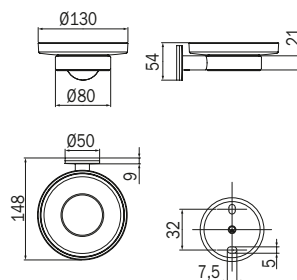

		CR 21
cod.	pz.	€
A46110 ...	1	106,10

## A4611M

Portasapone a parete con bacinella in ottone cromato  
 Wall-mounted soap holder, with chrome-plated brass dish  
 Porte-savon mural avec coupelle en laiton chromé  
 Jabonera de pared con cubeta de latón cromado

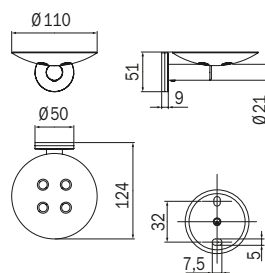

		CR
cod.	pz.	€
A4611M ...	1	86,70

## A4667Z

Spandisapone da appoggio con contenitore in vetro satinato, erogatore in ottone cromato  
 Tabletop soap dispenser with satinized glass container and chrome-plated brass pump  
 Distributeur de savon à poser avec pot en verre satiné, doseur en laiton chromé  
 Dosificador de jabón líquido de apoyo con recipiente de vidrio satinado, dispensador de latón cromado

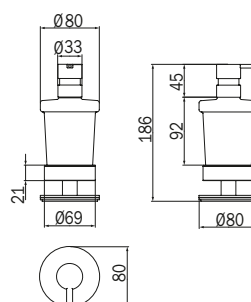

		CR 21
cod.	pz.	€
A4667Z ...	1	125,60

**A4610Z**

Portabicchiere da appoggio con bicchiere in vetro satinato  
 Tabletop tumbler, with satined glass tumbler  
 Porte-verre à poser avec verre en verre satiné  
 Portavasos de apoyo con vaso de vidrio satinado

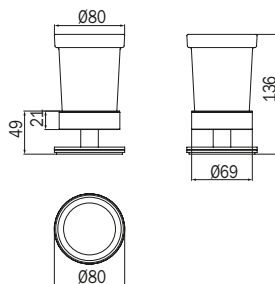

		CR 21
cod.	pz.	€
A4610Z ...	1	99,80

**A4611Z**

Portasapone da appoggio con bacinella in vetro satinato  
 Tabletop soap holder with satined glass dish  
 Porte-savon à poser avec coupelle en verre satiné  
 Jabonera de apoyo con cubeta de vidrio satinado

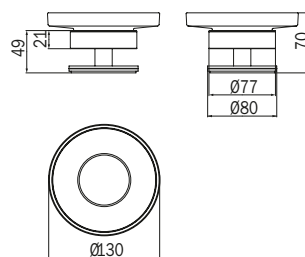

		CR 21
cod.	pz.	€
A4611Z ...	1	101,80

**A46250****SX**

Portarotolo  
 Paper holder  
 Porte-rouleau  
 Portarrollos

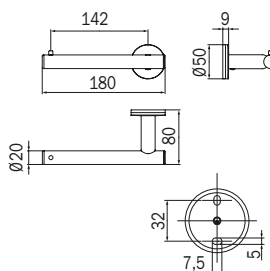
**A4625A****DX**

		CR
cod.	pz.	€
A46250 ...	1	78,10
A4625A ...	1	78,10

## TOUCH\_4600

**A46252**

Portarotolo doppio  
Double paper holder  
Porte-rouleau double  
Portarrollos doble

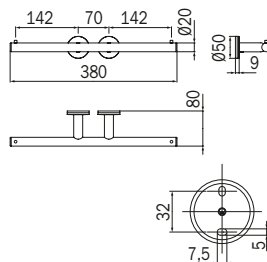

		CR
cod.	pz.	€
A46252 ...	1	133,20

**A4626B**

Portarotolo basculante con coperchio  
Tilting roll holder with cover  
Porte-rouleau basculant avec couvercle  
Portarrollos basculante con tapa

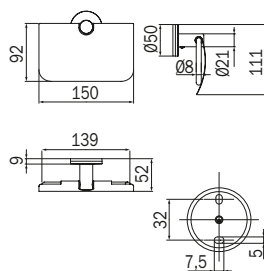

		CR
cod.	pz.	€
A4626B ...	1	93,20

**A46280**

Portarotolo di scorta  
Spare roll holder  
Porte-rouleau réserve  
Portarrollos de repuesto

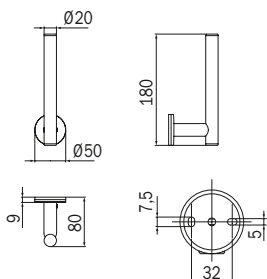

		CR
cod.	pz.	€
A46280 ...	1	72,70

**A46510**

Cestino  
Basket  
Panier  
Jabonera de rejilla

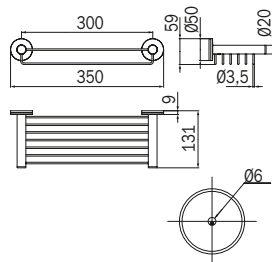
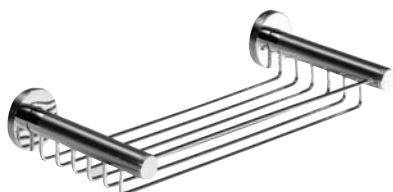

		CR
cod.	pz.	€
A46510 ...	1	164,60

**A46080**

Mensola in cristallo satinato temperato 6 mm con supporti  
Tempered satined crystal shelf, 6 mm glass, with brackets  
Tablette en cristal trempé 6 mm avec supports  
Repisa de cristal satinado templado 6 mm con soportes

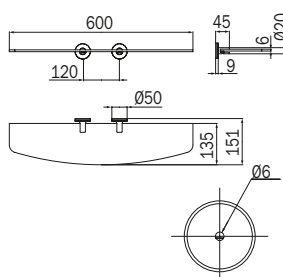

		CR 21
cod.	pz.	€
A46080 ...	1	206,90

**A4690M**

Maniglione di sicurezza  
Safety grip  
Barre d'appui de sécurité  
Manillón de seguridad

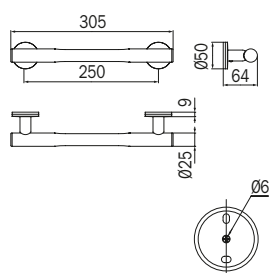

		CR
cod.	pz.	€
A4690M ...	1	105,10



1.200N  
~120Kg

## TOUCH\_4600

## AV014A

Portascopino da parete/da appoggio. Scovolo di ricambio bianco incluso  
 Wall mounted/free-standing toilet brush holder. White spare brush included  
 Porte-balai mural/à poser. Balayette de rechange blanche incluse  
 Escobillero de pared/de suelo. Escobilla de repuesto blanca incluida

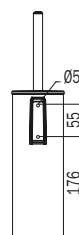
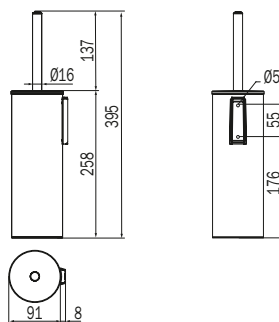

cod.	pz.	€
AV014A ...	1	100,80

CR

## AV014B

Portascopino da parete/da appoggio. Scovolo di ricambio grigio incluso  
 Wall mounted/free-standing toilet brush holder. Grey spare brush included  
 Porte-balai mural/à poser. Balayette de rechange grise incluse  
 Escobillero de pared/de suelo. Escobilla de repuesto gris incluida

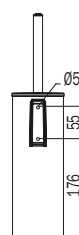
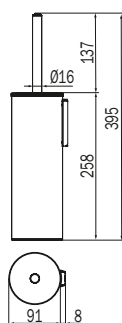

cod.	pz.	€
AV014B ...	1	100,80

CR



TOUCH  
4600

## RAFFAELLA\_3200



**IT** La serie Raffaella interpreta con eloquenza canoni tradizionali e sapori di un passato senza tempo, che affonda le proprie radici in forme di antica memoria. Le finiture e la qualità dei materiali proposti si rifanno alla tradizione, sottolineando con il loro stile la cura del dettaglio.

**EN** The serie Raffaella interprets with eloquence traditional canons and tastes of a timeless past which has its roots in old memory forms. The finishing and the quality of the materials proposed are based on tradition, underlining with their style the attention to the detail.

**FR** La série Raffaella interprète avec éloquence les canons traditionnels et saveurs d'un passé sans temps, qui a ses racines dans les anciennes mémoires. Les finitions et la qualité des matériaux se réfèrent à la tradition, en soulignant avec son style le sion du détail.

**ES** Raffaella interpreta con elocuencia canones tradicionales y sabores de un pasado sin tiempo que arraiga las propias raíces en forma de antigua memoria. Las terminaciones y la calidad de los materiales propuestos evocan lo tradicional, subrayando con su estilo al cuidado del detalle.

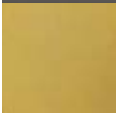
# RAFFAELLA

	<b>CR</b> Cromato Chrome-plated Chromé Cromado
	<b>DR</b> Dorato 24 carati Gilded 24 carats Doré 24 carats Dorado 24 quilates
	<b>BZ</b> Bronzo Bronzed Bronze Bronce







## RAFFAELLA\_3200

## A3218

Portasalviette  
Towel holder  
Porte-serviettes  
Toallero

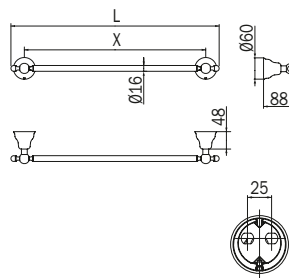

cod.	L	X	pz.			
				CR	BZ	DR
				€	€	€
A3218A ...	424	350	1	144,00	254,40	282,60
A3218B ...	574	500	1	148,40	263,10	291,10
A3218C ...	724	650	1	153,80	269,50	300,90

## A32150

Portasalviette doppio a snodo  
Double swing arm towel holder  
Porte-serviettes double mobile  
Toallero doble articulado

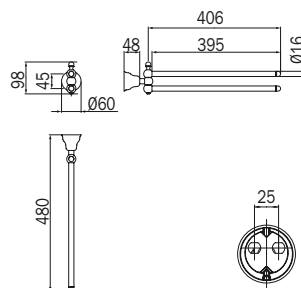

cod.	pz.			
		CR	BZ	DR
		€	€	€
A32150 ...	1	133,20	217,70	242,50

## A32160

Portasalviette ad anello  
Ring towel holder  
Porte-serviette anneau  
Toallero de aro

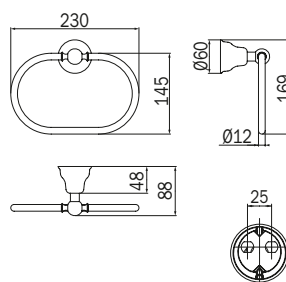

cod.	pz.			
		CR	BZ	DR
		€	€	€
A32160 ...	1	91,00	166,80	184,00

**A32680**

Portateli  
Bath towel holder  
Rack porte-serviettes  
Toallero/repisa

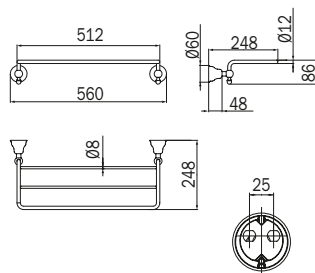

cod.	pz.			
		CR	BZ	DR
		€	€	€
<b>A32680 ...</b>	1	192,70	337,80	374,50

**A32200**

Appendiabiti doppio  
Double clothes hanger  
Patère double  
Percha doble

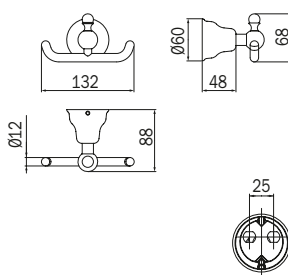

cod.	pz.			
		CR	BZ	DR
		€	€	€
<b>A32200 ...</b>	1	86,70	150,50	166,80

**A32120**

Spandisapone a parete  
Wall-mounted soap dispenser  
Distributeur de savon mural  
Dosificador de jabón líquido de pared

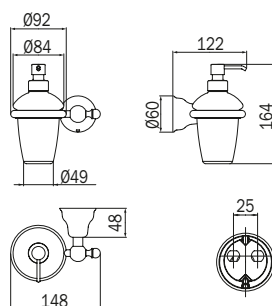

cod.	pz.			
		CR 21	BZ 21	DR 21
		€	€	€
<b>A32120 ...</b>	1	121,40	172,20	184,00

0,25 Lt.

## RAFFAELLA\_3200

## A32100

Portabicchiere a parete  
Wall-mounted tumbler holder  
Porte-verre mural avec verre  
Portavasos de pared

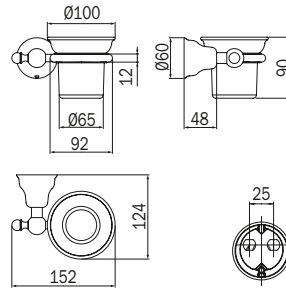

		CR 21	BZ 07	DR 21
cod.	pz.	€	€	€
A32100 ...	1	107,20	154,90	171,00

## A32110

Portasapone a parete  
Wall-mounted soap holder  
Porte-savon mural  
Jabonera de pared

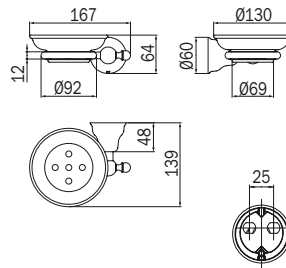

		CR 21	BZ 07	DR 21
cod.	pz.	€	€	€
A32110 ...	1	102,90	151,60	167,80

## A32250

Portarotolo  
Paper holder  
Porte-rouleau  
Portarrollos

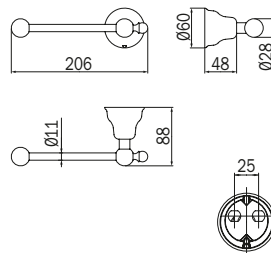

		CR	BZ	DR
cod.	pz.	€	€	€
A32250 ...	1	75,90	138,60	154,90

**A32260**

Portarotolo  
Paper holder  
Porte-rouleau  
Portarrollos

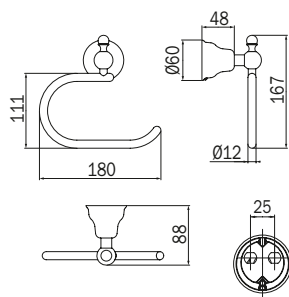

cod.	pz.			
		CR	BZ	DR
		€	€	€
<b>A32260 ...</b>	1	100,80	174,40	193,80

**A3226A**

Portarotolo con coperchio  
Paper holder with cover  
Porte-rouleau avec couvercle  
Portarrollos con tapa

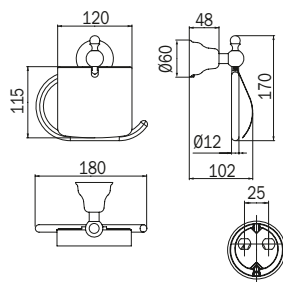

cod.	pz.			
		CR	BZ	DR
		€	€	€
<b>A3226A ...</b>	1	127,80	226,20	253,30

**A32500**

Cestino  
Basket  
Panier porte-savon  
Jabonera de rejilla

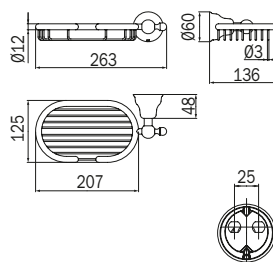

cod.	pz.			
		CR	BZ	DR
		€	€	€
<b>A32500 ...</b>	1	125,60	205,60	229,50

## RAFFAELLA\_3200

## A32920

Maniglione con cestino  
 Grab-bar with basket  
 Barre d'appui avec panier  
 Manillón con jabonera

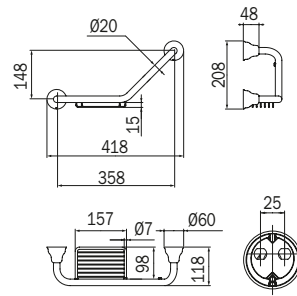

cod.	pz.			
		CR	BZ	DR
		€	€	€
A32920 ...	1	175,50	251,20	278,10

## A32080

Mensola in cristallo satinato temperato 5 mm  
 Tempered satined crystal shelf, 5 mm glass  
 Tablette en cristal satiné trempé, épaisseur 5 mm  
 Repisa de cristal satinado templado espesor vidrio 5 mm

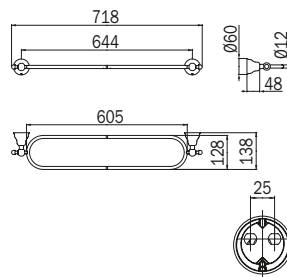

cod.	pz.			
		CR 21	BZ 21	DR 21
		€	€	€
A32080 ...	1	251,20	366,80	408,00

## A32850

Piantana con 3 portasalviette  
 Stand with 3 towel holders  
 Porte-serviettes sur pied avec 3 porte-serviettes  
 Toallero de pie con 3 brazos

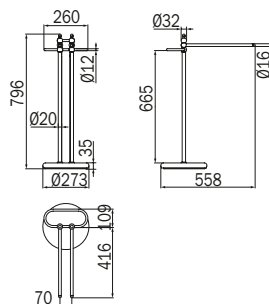

cod.	pz.			
		CR	BZ	DR
		€	€	€
A32850 ...	1	377,60	656,90	729,40

**A32240**

Piantana con portarotolo e portascopino  
 Stand with paper and toilet brush holder  
 Accessoire sur pied avec porte-rouleau et porte-balai  
 Toallero de pie con portarollos y escobillero

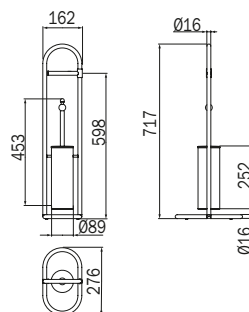

cod.	pz.	€	CR
A32240 ...	1	242,50	

**A37140**

Portascopino da parete/da appoggio  
 Wall mounted/free-standing toilet brush holder  
 Porte-balai mural/à poser  
 Escobillero de pared/de suelo

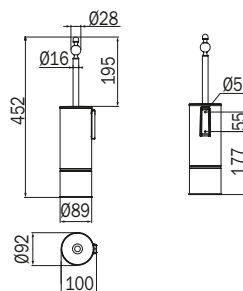

cod.	pz.	€	CR	BZ	DR
A37140 ...	1	105,10	189,50	208,90	

# FORUM QUADRA

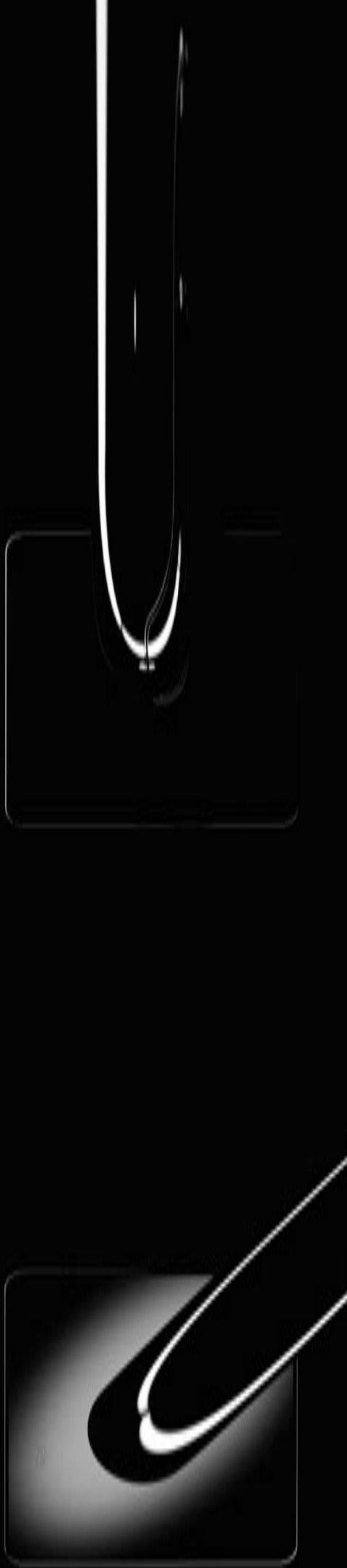

## FORUM QUADRA\_3000

- IT Linee curve che si integrano a forme squadrate in un design originale e versatile. Una nuova gamma in cui la funzionalità è protagonista.
- EN Curved lines and square shapes are integrated in a creative and versatile design. A new series where functionality becomes the protagonist.
- FR Des lignes courbes s'intègrent avec des formes carrées dans un design original et versatile. Une nouvelle gamme où la fonctionnalité devient protagoniste.
- ES Líneas curvas que se integran en formas cuadradas en un diseño original y versátil. Una nueva gama en la que la funcionalidad es la protagonista.



**CR** Cromato  
 Chrome-plated  
 Chromé  
 Cromado







FORUM QUADRA  
3000





FORUM QUADRA  
3000

## FORUM\_QUADRA 3000

## A3018A

Portasalviette  
Towel holder  
Porte-serviettes  
Toallero

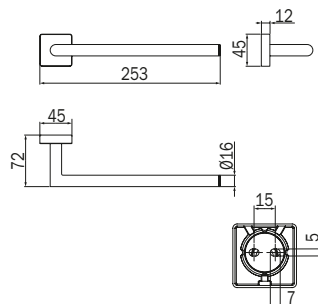

		CR
cod.	pz.	€
A3018A ...	1	34,80

## A3018

Portasalviette  
Towel holder  
Porte-serviettes  
Toallero

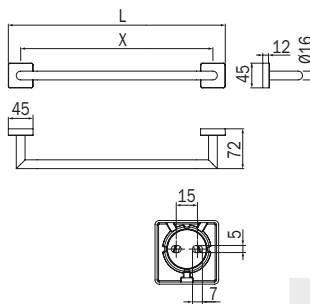

		CR		
cod.	L	X	pz.	€
A3018E ...	345	300	1	53,10
A3018B ...	503	458	1	56,50
A3018C ...	655	610	1	59,70
A3018D ...	855	810	1	82,30

## A3019C

Portasalviette doppio  
Double towel holder  
Porte-serviettes double  
Toallero doble

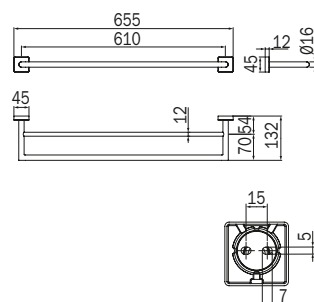

		CR	
cod.	pz.	€	
A3019C ...	1	109,40	

**A30150**

Portasalviette doppio a snodo  
 Double swing arm towel holder  
 Porte-serviettes double mobile  
 Toallero doble articulado

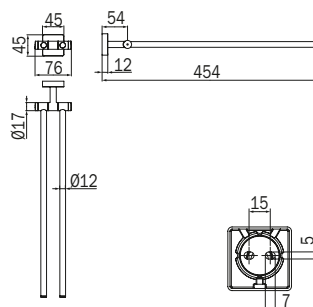

		CR
cod.	pz.	€
A30150 ...	1	75,90

**A3015A**

Portasalviette fisso a bandiera  
 Fixed towel holder  
 Porte-serviettes fixe à drapeau  
 Toallero fijo a bandera

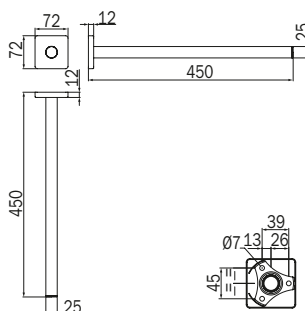

		CR
cod.	pz.	€
A3015A ...	1	41,80

**A30160**

Portasalviette ad anello  
 Ring towel holder  
 Porte-serviette anneau  
 Toallero de aro

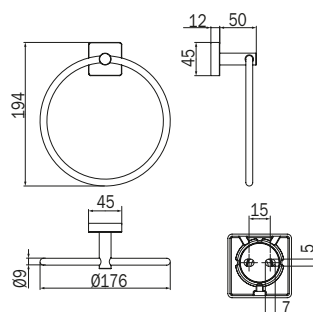

		CR
cod.	pz.	€
A30160 ...	1	44,50

## FORUM\_QUADRA 3000

## A3020A

Appendiabiti  
Clothes hanger  
Patère  
Percha

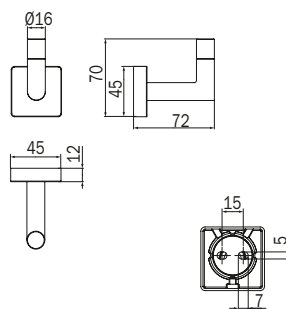

		CR
cod.	pz.	€
A3020A ...	1	26,10

## A3020B

Appendiabiti doppio  
Double clothes hanger  
Patère double  
Percha doble

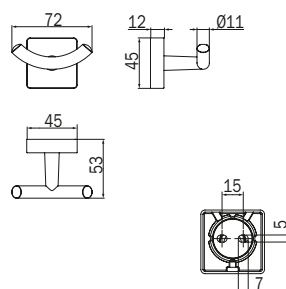

		CR
cod.	pz.	€
A3020B ...	1	26,10

## A30120

Spandisapone a parete con contenitore in vetro satinato, erogatore in ottone cromato  
Wall-mounted soap dispenser with satinated glass container and chrome-plated brass pump  
Distributeur de savon mural avec pot en verre satiné, doseur en laiton chromé  
Dosificador de jabón líquido de pared con recipiente de vidrio satinado, dispensador en latón cromado

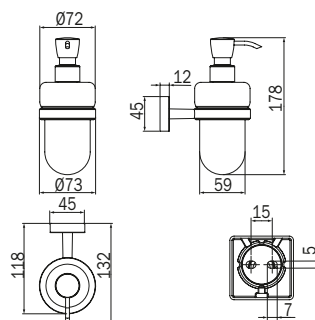

		CR 21
cod.	pz.	€
A30120 ...	1	61,80

**A30100**

Portabicchiere a parete con bicchiere in vetro satinato  
 Wall-mounted tumbler holder with satined glass tumbler  
 Porte-verre mural avec verre en verre satiné  
 Portavasos de pared con vaso de vidrio satinado

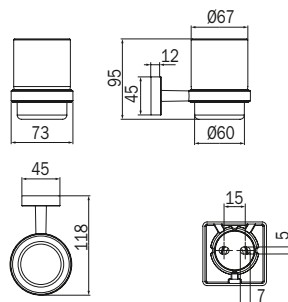

		CR 21
cod.	pz.	€
A30100 ...	1	34,80

**A3010D**

Portabicchiere a parete con 2 bicchieri in vetro satinato  
 Wall-mounted tumbler holder with 2 satined glass tumblers  
 Porte-verre mural avec 2 verres en verre satiné  
 Portavasos de pared con 2 vasos de vidrio satinado

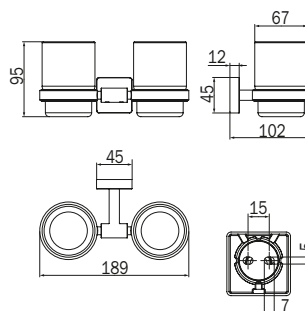

		CR 21
cod.	pz.	€
A3010D ...	1	56,50

**A30110**

Portasapone a parete con bacinella in vetro satinato  
 Wall-mounted soap holder with satined glass dish  
 Porte-savon mural avec coupelle en verre satiné  
 Jabonera de pared con cubeta de vidrio satinado

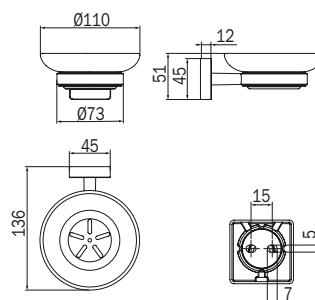

		CR 21
cod.	pz.	€
A30110 ...	1	34,80

## FORUM\_QUADRA 3000

## A30250

Portarotolo  
Paper holder  
Porte-rouleau  
Portarrollos

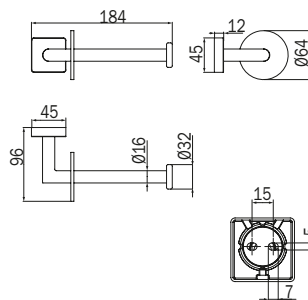

		CR
cod.	pz.	€
A30250 ...	1	42,30

## A3025B

Portarotolo basculante  
Tilting roll holder  
Porte-rouleau basculant  
Portarrollos basculante

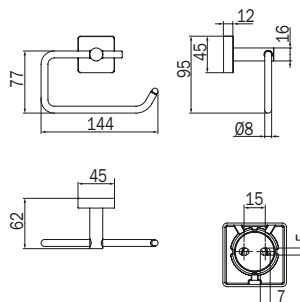

		CR
cod.	pz.	€
A3025B ...	1	49,60

## A30260

Portarotolo basculante con coperchio  
Tilting roll holder with cover  
Porte-rouleau basculant avec couvercle  
Portarrollo basculante con tapa

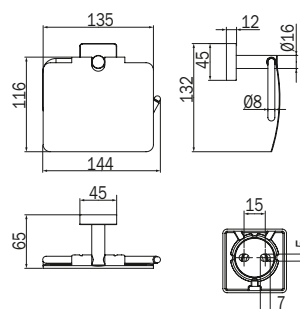

		CR
cod.	pz.	€
A30260 ...	1	53,10



**A30950**

Maniglione di sicurezza  
Safety grip  
Barre d'appui de sécurité  
Manillón de seguridad

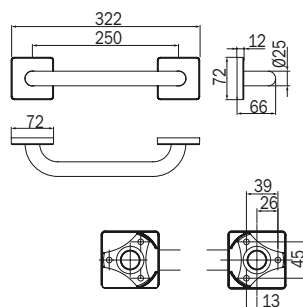

1.500N  
~150Kg

cod.	pz.	€
A30950 ...	1	53,60

CR

**A30090**

Mensola in cristallo satinato temperato 6 mm con supporti  
Tempered satined crystal shelf, 6 mm glass, with brackets  
Tablette en verre satiné trempé 6 mm avec supports  
Repisa de cristal templado satinado 6 mm con soportes

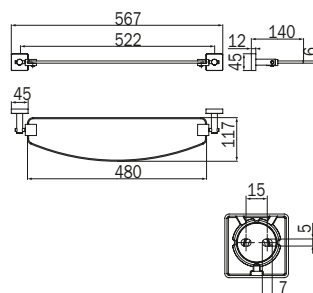

cod.	pz.	€
A30090 ...	1	81,30

CR 26

**A30140**

Portascopino da parete con bacinella in vetro satinato  
Wall-mounted toilet brush holder, with satined glass dish  
Porte-balai mural avec coupelle en verre satiné  
Escobillero de pared con cubeta de vidrio satinado

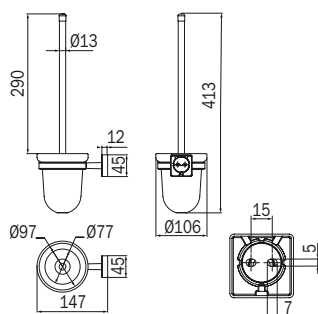

cod.	pz.	€
A30140 ...	1	61,80

CR 21

## FORUM\_3600

IT Forum: una gamma completa con un estetismo essenziale; una serie pensata per offrire un'ampia scelta di prodotti funzionali.

EN Forum: a complete range with an essential aestheticism, a series designed in order to offer a large range of functional products.

FR Forum: une gamme complète ayant un esthétisme extrêmement essentiel, une série pensée pour offrir un large choix de produits fonctionnels.

ES Forum: gama completa con una estética esencial, una serie pensada para ofrecer una amplio surtido de productos funcionales.



**CR** Cromato  
Chrome-plated  
Chromé  
Cromado

# FORUM





FORUM  
3600





## FORUM\_3600

## R0000K

NEW

Kit fissaggio a parete. Include confezione colla bicomponente a posa rapida. (kit opzionale)  
 Wall mounting kit. It includes one package of two-component adhesive for quick installation. (optional kit)  
 Kit de fixation murale. Comprend un set de colle à pose rapide à deux composants. (kit en option)  
 Kit fijación a pared opcional. Incluye 2 pegamento bicomponente a instalación rápida

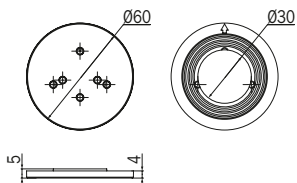

cod.	pz.	€
R0000K	1	15,10

## A3618A

Portasalviette  
 Towel holder  
 Porte-serviettes  
 Toallero

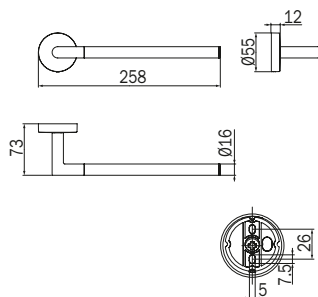

cod.	pz.	€	CR
A3618A ...	1	28,10	



## A3618

Portasalviette  
 Towel holder  
 Porte-serviettes  
 Toallero

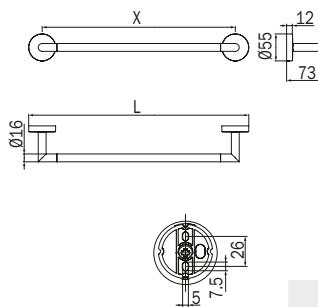

cod.	L	X	pz.	€	CR
A3618E ...	355	300	1	41,80	
A3618B ...	513	458	1	46,20	
A3618C ...	665	610	1	49,60	
A3618D ...	865	810	1	75,90	



**A3690**

Portasalviette  
Towel holder  
Porte-serviettes  
Toallero

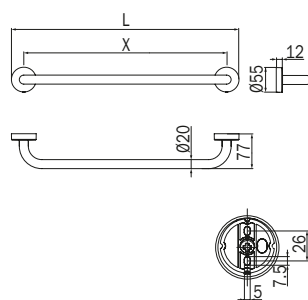

cod.	L	X	pz.	CR	€
<b>A3690A ...</b>	<b>355</b>	300	1		48,70
<b>A3690B ...</b>	<b>505</b>	450	1		55,40
<b>A3690C ...</b>	<b>655</b>	600	1		62,90

**A3619C**

Portasalviette doppio  
Double towel holder  
Porte-serviettes double  
Toallero doble

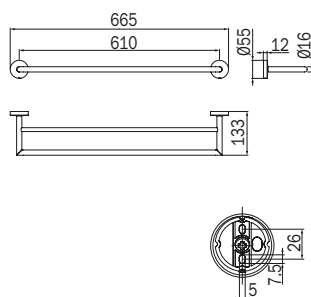

cod.	L	X	pz.	CR	€
<b>A3619C ...</b>	<b>665</b>	610	1		91,00

**A36150**

Portasalviette doppio a snodo  
Double swing arm towel holder  
Porte-serviettes double mobile  
Toallero doble articulado

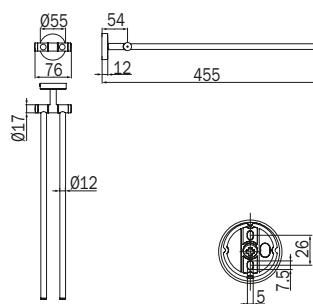
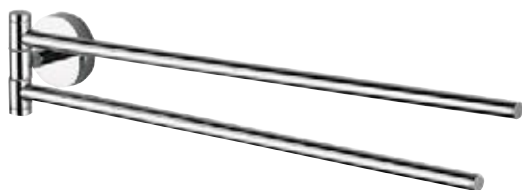

cod.	pz.	CR	€
<b>A36150 ...</b>	1		65,00

## FORUM\_3600

## A36160

Portasalviette ad anello  
Ring towel holder  
Porte-serviette anneau  
Toallero de aro

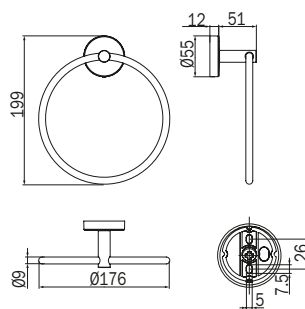

		CR
cod.	pz.	€
A36160 ...	1	35,80

## A3620A

Appendiabiti  
Clothes hanger  
Patère  
Percha

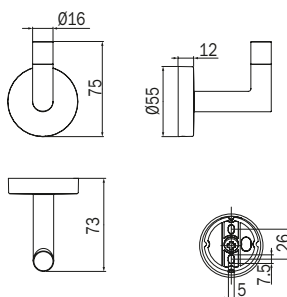

		CR
cod.	pz.	€
A3620A ...	1	19,60

## A3620B

Appendiabiti doppio  
Double clothes hanger  
Patère double  
Percha doble

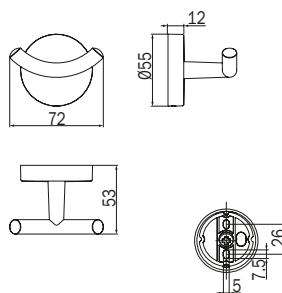

		CR
cod.	pz.	€
A3620B ...	1	21,20



**A36120**

Spandisapone a parete con contenitore in vetro satinato, erogatore in ottone cromato  
 Wall-mounted soap dispenser with satinated glass container and chrome-plated brass pump  
 Distributeur de savon mural avec pot en verre satiné, doseur en laiton chromé  
 Dosificador de jabón líquido de pared con recipiente de vidrio satinado, dispensador en latón cromado

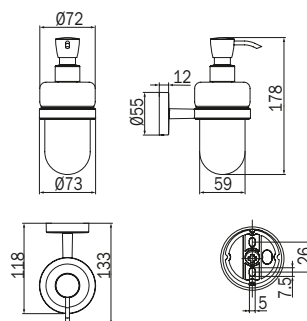

0,25 Lt.

cod.	pz.	€
A36120 ...	1	51,70

CR 21

**A36100**

Portabicchiere a parete con bicchiere in vetro satinato  
 Wall-mounted tumbler holder with satinated glass tumbler  
 Porte-verre mural avec verre en verre satiné  
 Portavaso de pared con vaso de vidrio satinado

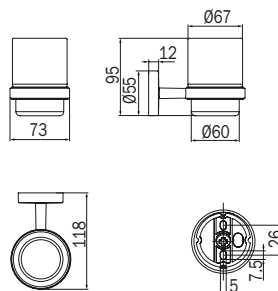

Kit

cod.	pz.	€
A36100 ...	1	28,10

CR 21

**A3610D**

Portabicchiere a parete con 2 bicchieri in vetro satinato  
 Wall-mounted tumbler holder with 2 satinated glass tumblers  
 Porte-verre mural avec 2 verres en verre satiné  
 Portavaso de pared con 2 vasos de vidrio satinado

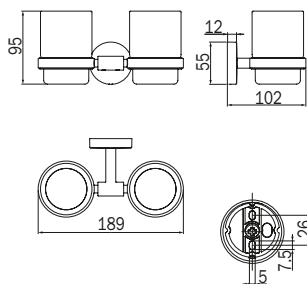

cod.	pz.	€
A3610D ...	1	47,80

CR 21

## FORUM\_3600

## A36110

Portasapone a parete con bacinella in vetro satinato  
 Wall-mounted soap holder with satinized glass dish  
 Porte-savon mural avec coupelle en verre satiné  
 Jabonera de pared con cubeta de vidrio satinado

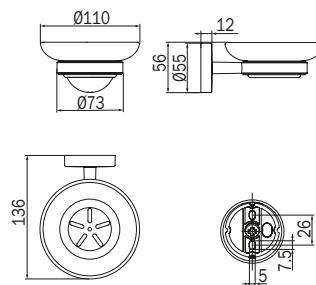

cod.	pz.	€
A36110 ...	1	28,10

CR 21

## A36250

Portarotolo  
 Paper holder  
 Porte-rouleau  
 Portarrollos

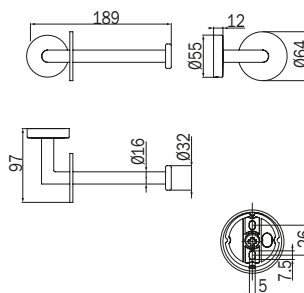

cod.	pz.	€
A36250 ...	1	35,10

CR

## A3625B

Portarotolo basculante  
 Tilting roll holder  
 Porte-rouleau basculant  
 Portarrollos basculante

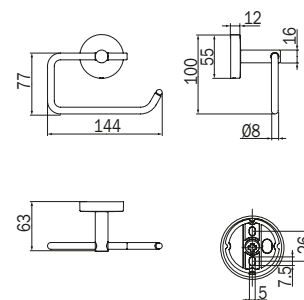

cod.	pz.	€
A3625B ...	1	43,70

CR

**A36260**

Portarotolo basculante con coperchio  
 Tilting roll holder with cover  
 Porte-rouleau basculant avec couvercle  
 Portarrollo basculante con tapa

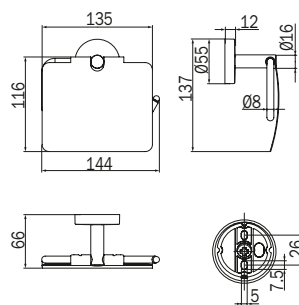

		CR
cod.	pz.	€
A36260 ...	1	45,20

**A36920**

Maniglione con cestino  
 Grab-bar with basket  
 Barre d'appui avec panier  
 Manillón con jabonera

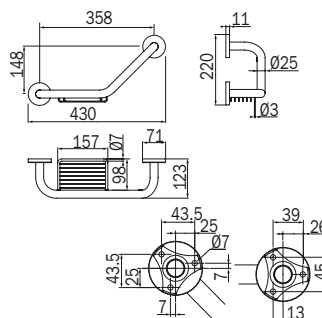
1.500N  
~150Kg

		CR
cod.	pz.	€
A36920 ...	1	87,80

**A36950**

Maniglione di sicurezza  
 Safety grip  
 Barre d'appui de sécurité  
 Manillón de seguridad

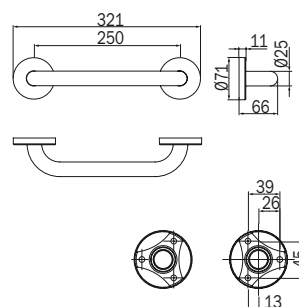
1.500N  
~150Kg

		CR
cod.	pz.	€
A36950 ...	1	50,50

## FORUM\_3600

## A36090

Mensola in cristallo satinato temperato 6 mm con supporti  
 Tempered satined crystal shelf, 6 mm glass, with brackets  
 Tablette en verre satiné trempé 6 mm avec supports  
 Repisa de cristal templado satinado 6 mm con soportes

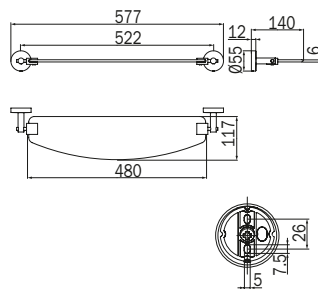

		CR 26
cod.	pz.	€
A36090 ...	1	68,30

## A36140

Portascopino da parete con bacinella in vetro satinato  
 Wall-mounted toilet brush holder, with satined glass dish  
 Porte-balai mural avec coupelle en verre satiné  
 Escobillero de pared con cubeta de vidrio satinado

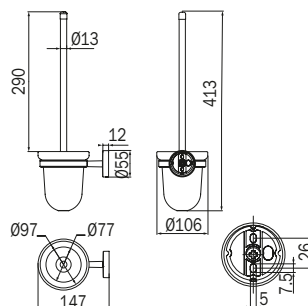

		CR 21
cod.	pz.	€
A36140 ...	1	51,70





FORUM  
3600

# COLORELLA



## COLORELLA\_2300

- IT Colorella: linea universale abbinabile a qualsiasi tipo di bagno, in sintonia perfetta con un gusto che predilige lo stile più moderno e la linearità di forme e volumi.
- EN Colorella: universal line, suitable to all bathroom types, in perfect harmony with the taste which prefers the modern style and the linearity of forms and volumes.
- FR Colorella: ligne intemporelle, s'adaptant à tous les styles de salle de bains, en parfaite harmonie avec un goût qui favorise le style le plus moderne et la linéarité des formes et des volumes.
- ES Colorella: línea universal, ideal para cualquier cuarto de baño, en perfecta sintonía con un gusto que apuesta por un estilo moderno, lineal en sus formas y volúmenes.



**CR** Cromato  
 Chrome-plated  
 Chromé  
 Cromado





## COLORELLA\_2300

### A2390

Portasalviette. 007: confezione da 10 pz.  
Towel holder. 007: the packing contains 10 pcs.  
Porte-serviettes. 007: lot de 10 pz.  
Toallero. 007: paquete de 10 piezas

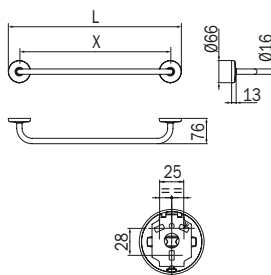

cod.	L	X	pz.	CR	
				€	€
A2390A ...	366	300	1	40,60	37,40
A2390B ...	516	450	1	44,80	41,10
A2390C ...	666	600	1	49,00	45,20
A2390D ...	866	800	1	58,60	

### A2391

Portasalviette doppio. 007: confezione da 10 pz.  
Double towel holder. 007: the packing contains 10 pcs.  
Porte-serviettes double. 007: lot de 10 pz.  
Toallero doble. 007: paquete de 10 piezas

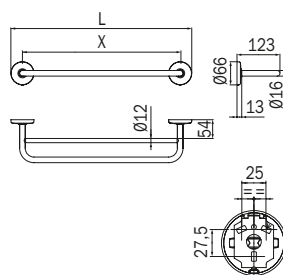

cod.	L	X	pz.	CR	
				€	€
A2391B ...	516	450	1	81,30	
A2391C ...	666	600	1	86,70	73,70

### A23150

Portasalviette doppio a snodo. 007: confezione da 10 pz.  
Double swing arm towel holder. 007: the packing contains 10 pcs.  
Porte-serviettes double mobile. 007: lot de 10 pz.  
Toallero doble articulado. 007: paquete de 10 piezas

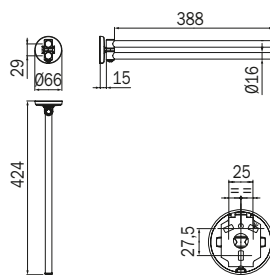

cod.	pz.	CR	
		€	€
A23150 ...	1	56,50	50,70



**A2316T**

Portasalviette ad anello. 007: confezione da 10 pz.  
 Ring towel holder. 007: the packing contains 10 pcs.  
 Porte-serviette anneau. 007: lot de 10 pz.  
 Toallero de aro. 007: paquete de 10 piezas

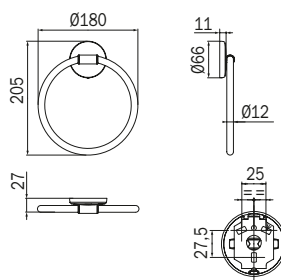

		CR		CR 007
cod.	pz.	€	€	€
A2316T ...	1	35,60	32,60	

**A23210**

Appendiabiti. 007: confezione da 10 pz.  
 Clothes hanger. 007: the packing contains 10 pcs.  
 Patère. 007: lot de 10 pz.  
 Percha. 007: paquete de 10 piezas

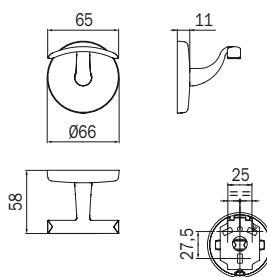

		CR		CR 007
cod.	pz.	€	€	€
A23210 ...	1	23,90	22,00	

**A2367A**

Spandisapone a parete con contenitore in vetro satinato, erogatore in ottone cromato  
 Wall-mounted soap dispenser with satinated glass container and chrome-plated brass pump  
 Distributeur de savon mural avec pot en verre satiné, doseur en laiton chromé  
 Dosificador de jabón líquido de pared con recipiente de vidrio satinado, dispensador de latón cromado

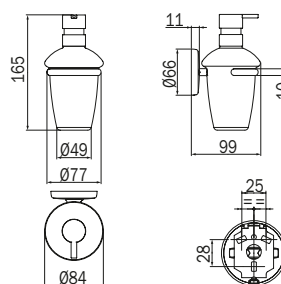

		CR 21	
cod.	pz.	€	€
A2367A ...	1	85,50	

0,25 Lt.

## COLORELLA\_2300

### A23100

Portabicchiere a parete con bicchiere in vetro extrachiario trasparente  
 Wall-mounted tumbler holder with extra clear transparent glass tumbler  
 Porte-verre mural avec verre en verre transparent extra clair  
 Portavasos de pared con vaso de vidrio extraclaro transparente

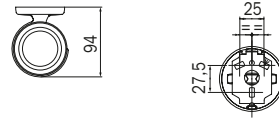
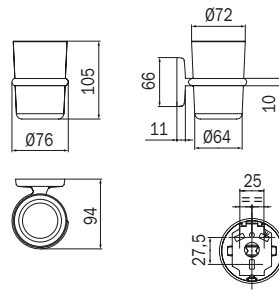

		CR 03	
cod.	pz.	€	
A23100 ...	1	32,90	

### A05090

Portasapone da appoggio. 003: confezione da 20 pz.  
 Free-standing soap holder. 003: the packing contains 20 pcs.  
 Porte-savon à poser. 003: lot de 20 pz.  
 Jabonera de apoyo. 003: paquete de 20 piezas

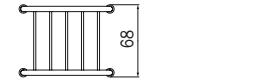
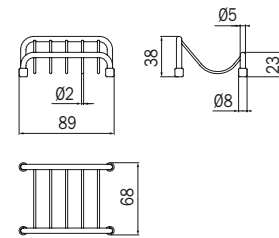

		CR		CR 003
cod.	pz.	€	€	
A05090 ...	1	14,80	10,10	

### A23110

Portasapone a parete con bacinella in vetro extrachiario trasparente  
 Wall-mounted soap holder with extra clear transparent glass dish  
 Porte-savon mural avec coupelle en verre transparent extra clair  
 Jabonera de pared con cubeta de vidrio extraclaro transparente

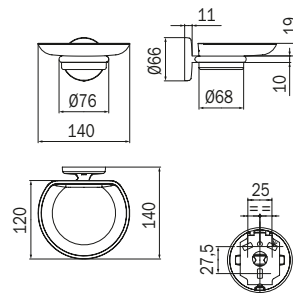

		CR 03	
cod.	pz.	€	
A23110 ...	1	40,60	

**A2310N**

Anello supporto a parete da completare con... R03110 - R01110 - R01100 - R03600. 007: confezione da 10 pz.  
 Wall support ring to be completed with... R03110 - R01110 - R01100 - R03600. 007: the packing contains 10 pcs.  
 Anneau de support mural à compléter avec... R03110 - R01110 - R01100 - R03600. 007: lot de 10 pz.  
 Aro de soporte a pared de completar con... R03110 - R01110 - R01100 - R03600. 007: paquete de 10 piezas

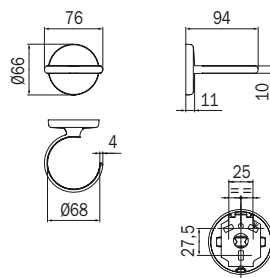

CR 007

cod.	pz.	€
A2310N ...	1	20,80

**A2317N**

NEW

Anello doppio supporto a parete da completare con... R03110 - R01110 - R01100 - R03600. 003: confezione da 10 pz.  
 Double ring wall support to be completed with... R03110 - R01110 - R01100 - R03600. 003: the packing contains 10 pcs.  
 Double anneau de support à paroi à compléter... R03110 - R01110 - R01100 - R03600. 003: lot de 10 pz.  
 Aro doble soporte a pared de completar con... R03110 - R01110 - R01100 - R03600. 003: paquete de 10 piezas

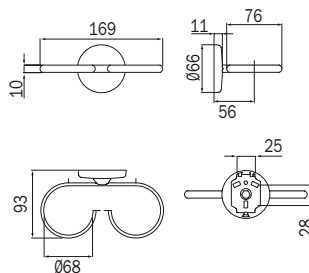

CR 003

cod.	pz.	€
A2317N ...	1	28,00

**R03110**

Bacinella in vetro extrachiaro trasparente per art. A2310N  
 Extra clear transparent glass dish for art. A2310N  
 Coupelle en verre transparent extra clair pour art. A2310N  
 Cubeta de vidrio transparente extraclaro para art. A2310N

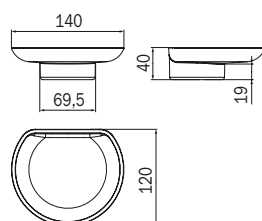

cod.	pz.	€
R03110	1	20,10

## COLORELLA\_2300

### R01110

Bacinella in PMMA per art. A2310N  
 PMMA dish for art. A2310N  
 Coupelle en PMMA pour art. A2310N  
 Cubeta en PMMA para art. A2310N

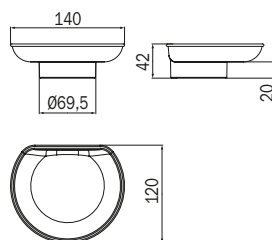

cod.	pz.	€
R01110	1	5,40

### R01100

Bicchiere in PMMA per artt. A2310N - A2317N  
 PMMA tumbler for arts. A2310N - A2317N  
 Verre en PMMA pour les arts. A2310N - A2317N  
 Vaso en PMMA para los art. A2310N - A2317N

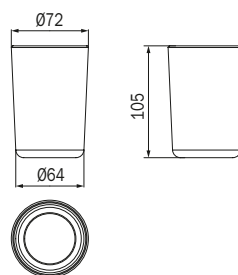

cod.	pz.	€
R01100	1	5,40

### R03600

Bicchiere in vetro extrachiaro trasparente per artt. A2310N - A2317N  
 Extra clear transparent glass tumbler for arts. A2310N - A2317N  
 Verre en verre transparent extra clair pour les arts. A2310N - A2317N  
 Vaso de vidrio transparente extraclaro para los art. A2310N - A2317N

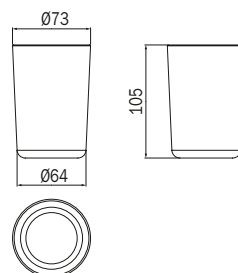

cod.	pz.	€
R03600	1	12,80

**A23250**

Portarotolo. 007: confezione da 10 pz.  
 Paper holder. 007: the packing contains 10 pcs.  
 Porte-rouleau. 007: lot de 10 pz.  
 Portarrollos. 007: paquete de 10 piezas

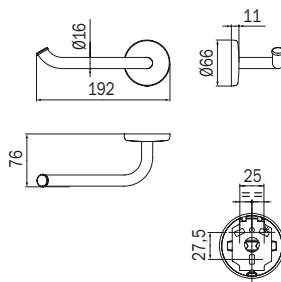

		CR		CR 007
cod.	pz.	€	€	€
A23250 ...	1	39,80		36,30

**A23260**

NEW

Portarotolo con coperchio. 003: confezione da 10 pz.  
 Paper holder with cover. 003: the packing contains 10 pcs.  
 Porte-rouleau avec couvercle. 003: lot de 10 pz.  
 Portarrollos con tapa. 003: paquete de 10 piezas

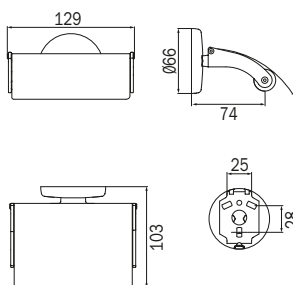

		CR		CR 003
cod.	pz.	€	€	€
A23260 ...	1	42,70		32,80

**A23270**

Portarotolo con coperchio. 007: confezione da 10 pz.  
 Paper holder with cover. 007: the packing contains 10 pcs.  
 Porte-rouleau avec couvercle. 007: lot de 10 pz.  
 Portarrollos con tapa. 007: paquete de 10 piezas

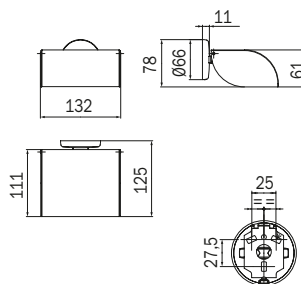

		CR		CR 007
cod.	pz.	€	€	€
A23270 ...	1	57,50		50,90

## COLORELLA\_2300

### A23280

Portarotolo di scorta. 007: confezione da 10 pz.  
Spare roll holder. 007: the packing contains 10 pcs.  
Porte-rouleau de réserve. 007: lot de 10 pz.  
Portarrollos de repuesto. 007: paquete de 10 piezas

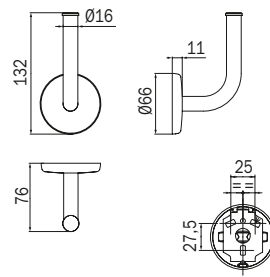

		CR		CR 007
cod.	pz.	€	€	€
A23280 ...	1	37,00	34,30	

### AV4284

Portarotolo da terra, 4 rotoli  
Free-standing paper holder, 4 rolls  
Porte-rouleau à poser, 4 rouleaux  
Portarrollos de suelo, 4 rollos

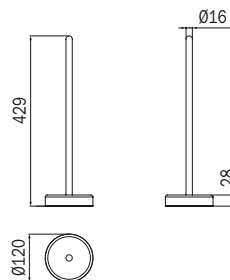

		CR	
cod.	pz.	€	€
AV4284 ...	1	44,40	

### A23070

Mensola in cristallo temperato 6 mm con supporti  
Tempered crystal shelf, 6 mm glass, with brackets  
Tablette en verre trempé transparent 6 mm avec fixations  
Repisa de cristal templado espesor vidrio 6 mm con soportes

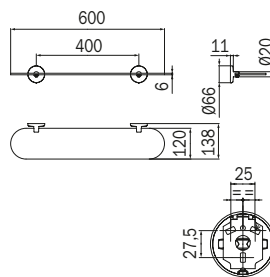

		CR 01	
cod.	pz.	€	€
A23070 ...	1	106,10	

**A2308**

Mensola in cristallo temperato 5 mm  
Tempered crystal shelf, 5 mm glass  
Tablette en verre trempé transparent 5 mm  
Repisa de cristal templado espesor vidrio 5 mm

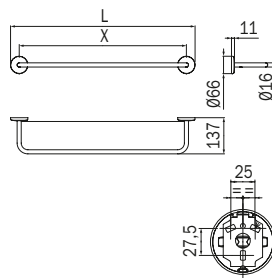

CR 01				
cod.	L	X	pz.	€
A2308A ...	601	535	1	120,30
A2308C ...	701	635	1	139,70

**A2307N**

NEW

Supporti in ottone cromato, confezionati in coppia, da completare con art R1150A, spessore vetro max 6 mm. 003: confezione da 10 pz  
Supports in chrome-plated brass, the packing contains 2 pieces, to be completed with art R1150A, max 6 mm thick glass. 003: the packing contains 10 pcs  
Supports en laiton, vendus par deux, à compléter avec l'art. R1150A, épaisseur verre max 6 mm. 003: lot de 10 pz  
Soportes de latón, paquetes de 2 unidades, para completar con el art. R1150A, espesor vidrio máx 6 mm. 003: paquete de 10 piezas

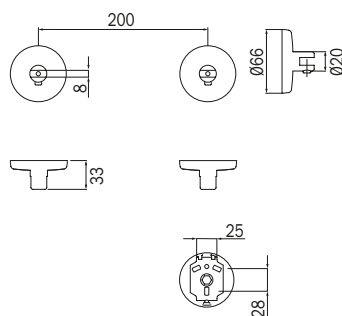

CR 003		
cod.	pz.	€
A2307N ...	1	42,40

**R1150A**

Ripiano in cristallo trasparente temperato. Spessore vetro 6 mm  
Shelf in transparent tempered crystal. 6 mm thick glass  
Tablette en verre trempé, épaisseur verre 6 mm  
Estante de cristal templado, espesor vidrio 6 mm

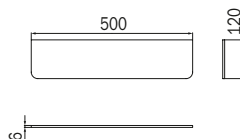

cod.	pz.	€
R1150A	1	43,60

## COLORELLA\_2300

### A04140

Portascopino da parete con bacinella in ABS cromato  
 Wall-mounted toilet brush holder with dish in chrome ABS  
 Porte-balai mural avec pot en ABS chromé  
 Escobillero de pared con cubeta de ABS cromado

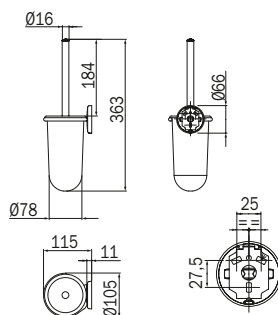

		CR
cod.	pz.	€
A04140 ...	1	68,30

### A05140

Portascopino da parete con bacinella in polipropilene (PP)  
 Wall-mounted toilet brush holder with dish in polypropylene (PP)  
 Porte-balai mural avec coupelle en polypropylène (PP)  
 Escobillero de pared con cubeta de polipropileno (PP)

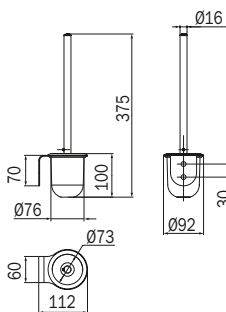

		CR
cod.	pz.	€
A05140 ...	1	56,50

### A07140

Portascopino da terra con bacinella in polipropilene (PP)  
 Free-standing toilet brush holder with basin in polypropylene (PP)  
 Porte-balai à poser avec coupelle en polypropylène (PP)  
 Escobillero de suelo con cubeta de polipropileno (PP)

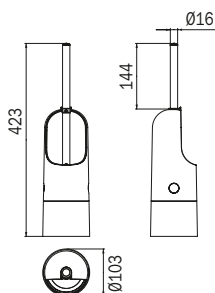

		WW
cod.	pz.	€
A07140 ...	1	38,30



**AV014A**

Portascopino da parete/da appoggio. Scovolo di ricambio bianco incluso  
 Wall mounted/free-standing toilet brush holder. White spare brush included  
 Porte-balai mural/à poser. Balayette de rechange blanche incluse  
 Escobillero de pared/de suelo. Escobilla de repuesto blanca incluida

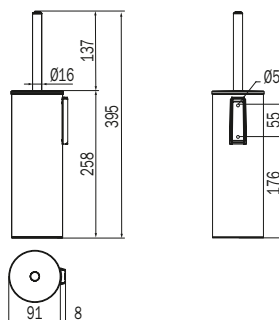

cod.	pz.	€
AV014A ...	1	100,80

CR

**AV014B**

Portascopino da parete/da appoggio. Scovolo di ricambio grigio incluso  
 Wall mounted/free-standing toilet brush holder. Grey spare brush included  
 Porte-balai mural/à poser. Balayette de rechange grise incluse  
 Escobillero de pared/de suelo. Escobilla de repuesto gris incluida

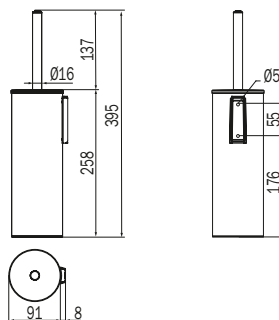

cod.	pz.	€
AV014B ...	1	100,80

CR

**AV414A**

Portascopino da parete/da appoggio  
 Wall mounted/free-standing toilet brush holder  
 Porte-balai mural/à poser  
 Escobillero de pared/de suelo

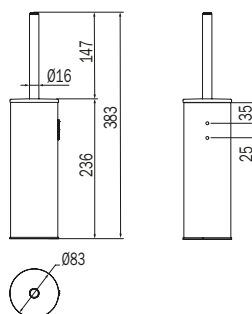

cod.	pz.	€
AV414A ...	1	81,40

AL

## COLORELLA\_2300

### A23240

Piantana con portarotolo e portascopino  
 Stand with paper and toilet brush holder  
 Accessoire sur pied avec porte-rouleau et porte-balai  
 Toallero de pie con portarrollos y escobillero

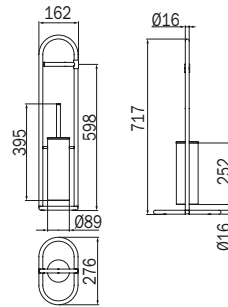

cod.	pz.	€
A23240 ...	1	241,50

CR

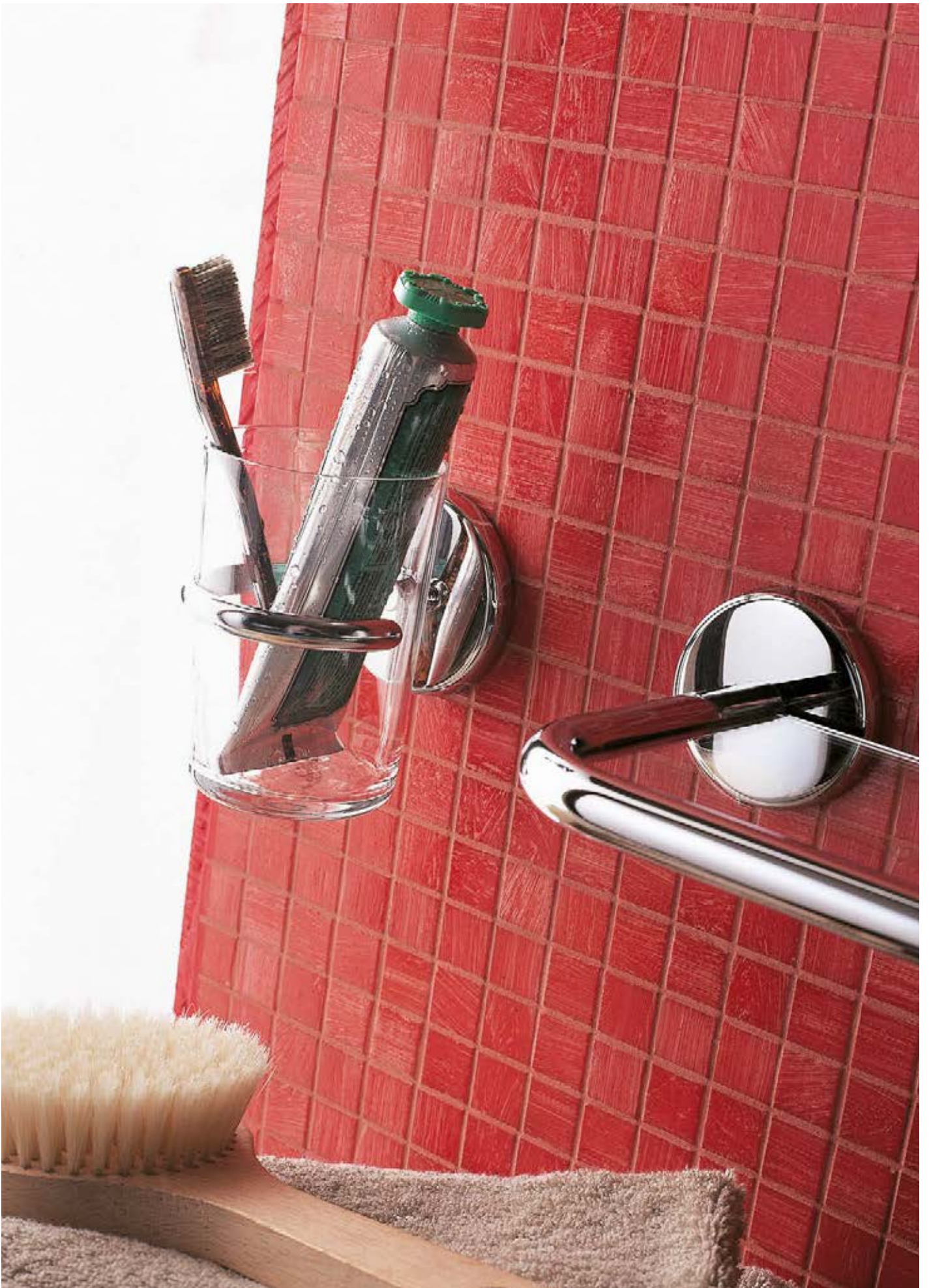

Club Med Pointe aux Cannoniers, Grand Baie - Hotel St. George's Bay - Choice Hotel Gardermoen, Jessheim - Orbis Hotel Grand Sopot, Sopot - Hotel Marina Clube, Lagos - Hotel Opalia, Constanta - Palace Hotel  
Napa Bay - Hotel Imperial Praha, Prague - Marriott Airport Prague Prague, Prague - Hotel Pokr, Liberec 6 - Hilton Helsinki airport, Helsinki - Mercure Aix Roi Rer  
o, Opio - Hotel Le Belmont, Paris - Hotel Waldorf Arc de Triomphe, Paris - Sofitel porte de Sevres, Paris - Holiday Inn Samara, Samara - Rocco Forte Hotel de  
ttgart - Moevenpick Hotel Stuttgart, Stuttgart - Grecotel Corfu Imperial, Corfu - Grecotel Club Creta Sun, Creta - Grecotel Creta Palace, Creta - Aldemar Royal Mar  
el New York Palace, Budapest - Danubius Termal Hotel Magitsziget, Margitsziget - Bettystown Hotel Ireland, Ireland - Ramada at the Castle Trim County Meath,  
Mucini, Massa Marittima (Gr) - Hotel Nikken, Milano - Jolly Hotel Touring, Milano - Starhotel Rosa, Milano - UNA Hotel Napoli, Napoli - Hilton des Palmes, Palerm  
l) - Hotel Schloss, Pontresina - Holiday Inn Express (via Tuscolana), Roma - Hotel Colonna Palace, Roma - Hotel Ritz, Roma - Hotel Ergife, Rome - Hilton Garder  
l, St. George's Bay - Choice Hotel Gardermoen, Jessheim - Orbis Hotel Grand Sopot, Sopot - Hotel Marina Clube, Lagos - Hotel Opalia, Constanta - Palace Hotel  
ni - Stonesta maho Beach Hotel, St. Marteen - Silhoutte Island Resort, Victoria Mahe - Hilton Hotel Alger, Alger - Kempinski Djibouti Palace, Djibouti - Kempinski  
ro - Dar Elfield Hotel, Cairo - Safeer Elzamalk, Giza - Hilton Hotel Luxor, Luxor - Reef Oasis Sharm El Sheikh, Sharm El Sheikh - Moevenpick Hotel, Gaza - Inte  
orhouse, Lagos - Ventaclub Karibu, Karibu - Le Meridien Amman, Amman - Hotel Solaria, La Marsa - Southern Sun Hotel A Burj Dubai, Dubai - Southern Sun Hotel  
ton, Prague - Hotel Imperial, Prague - Marriott Luxemburg Plaza, Prague - Courtyard by Marriott, Colombes - Monalisa Grand Hotel Du Hohwald, Le Hohwald H  
il Melia Berlin, Berlin - Courtyard by Marriott, Muenchen - Royal Olympic Hotel, Athens - Hotel Blue Bay, Ialissos Rhodes - Grecotel Daphniia Bay Thalasso, Ker  
ggio Olimpico, Torino - Zanhotel Bologna, Bologna - Thotel, Cagliari - UNA Hotel Palace, Catania - UNA Hotel Lodi, Lodi - Villaggio Albatros, Marina di Lesina (Pug  
Trasimeno (PG) - Hilton Hotel, Porto Rosa (Sicily) - Hotel Airone, Portoferraio - Isola d'Elba - Dorfhotel Villaggio Prugelato, Prugelato - Marriott Park Hotel, Roma  
ds Resort & Spa, Golden Bay - Baja Hotel, St. Julians - Cavalieri Hotel, St. Julians - Eurosol Hotel Estarreja, Estarreja - Hotel Pestana Carlton Casino Park, Funch  
mes, Milton Keynes - Sofitel Melbourne, Melbourne - Shangri-La Rasa Sayang Beach Resort, Penang - Hilton Hotel Magù, Magù - Sheraton Evian, Alger - Moevenpick M  
nge, Taba - Hotel Bahia, Malabo - Meridien Hotel, Amman - Moevenpick Resort Dead Sea, Amman - Crowne Plaza Petra, Amman - Regency Palace Hotel, Beirut -  
k Hotel, Tunis - Hotel Riu Palace, Cancun - Holiday Inn Cuernavaca, Cuernavaca - Sofitel Belfort, Gent - Sheraton Sofia Balkan, Sofia - Grand Hotel Bahia del D  
el Duesseldorf, Duesseldorf - Radisson Hotel, Frankfurt am Main - Marriott Hotel, Budapest - Polus Palace Hotel, Budapest - Hotel Pava Ramada, Budapest - Ho  
ly Hotel, Agrigento - Una Hotel Bologna, Bologna - Crowne Plaza Hotel, Caserta - Grandi Viaggi Club Santa Giusta, Castiadas (Ca) - Boscolo Hotel Granducato, F  
mina Hotel Giudecca, Venezia - Novotel quartier Europeen Nord, Kirchberg - Radisson Hotel, Belfast - Hotel Capitolio Malhoa, Aveiro Codex - Sana Lisboa Park  
apa Gading Square Proj., Jakarta - Renaissance Condominium, Kuala Lumpur - Oriental Crystal Hotel, Selangor - Selangor Dredging Condominium, Selangor, B  
otel, Cairo - Golden Tulip Red Sea Hotel, Aqaba - Intercontinental Aqaba Beach Resort, Aqaba - Amman Al-Sham Hotel, Amman - Four Points Sheraton Hotel, Kuala  
teraton Bab El Faraj, Aleppo - Hotel du Lac, Tunis - Hotel Ginen, La Marsa - Hotel Orient Palace, Tunis - Arwami Project, Dubai - Riu Hotel Negril, Jamaica - Riu H  
diz) - Campanas Beach, Mallorca - Crowne Plaza Brussels Airport, Zaventem - Hotel Playa Canarias, Lanzarote - Natura Palace, Lanzarote - Sol Hotel Tenerife, T  
el, Prague - Domina II Marine, Tallinn - Hilton Hotel Kalastajatorrpa, Helsinki - Crowne Plaza Hotel, Helsinki - Express by Holiday Inn, Arras - MVCI, Bailly Romain  
is Eurodisney - Hilton Hotel, Paris La Défense - Grand Hotel Mercure, Paris Orly - Marriott Hotel, Berlin - Dorint Bayernpost, Muenchen - Radisson Hotel, Rostoc  
and Resort Lagonissi, Lagonissi - Hotel Olympian Village, Pirgos Ilios - Radisson Hotel, Budapest - Radisson Hotel, Letterkenney - Hotel Esja, Reykjavik - Hotel Cl  
el Vittoria, Firenze - Robinson Club Apulia, Lecce - Crowne Plaza, Malpensa - Maritalia Hotel Gusmay & Rotonda, Manacore, Peschici - Maritalia Hotel Palace Sa  
lita Hotel, Mellieha - Hilton Hotel & Conference center, St. Julians - Intercontinental Hotel, Warsaw - Marriott Warsaw Hotel, Warsaw - Lidia Hotel, - Piolets Park,  
a, Bilbao - Hotel Catalonia Bruselas, Bruselas - Fuerte Hotel Marina del Rempido, Huelva - Fuerte Aparthotel Marina, Huelva - Hapimag Hotel Marbella, Marbe  
rto Rico - Hotusa Hotel Quality Reus, Reus - Prestige Hotel Sol D'Or, Salou - Prestige Hotel Cap Salou, Salou - Hotel Guadamendi, San Sebastián - Santos Hot  
el Tres Cantos, Tres Cantos - Catalonia Hotel Zaragoza Plaza, Zaragoza - Holiday Inn, Zaragoza - The Clarion Hotel, Stockholm - Crowne Plaza Hotel, Geneva - E  
el, Phuket - Al Moayyed Tower Hotel, Manama - Ana Hotel, Kish Island - Petra Plaza Hotel, Petra - Grand View Hotel, Petra - King's Highway Hotel, Petra - Moever  
Amman - Intercontinental Amra Forum Hotel, Amman - Marriott Hotel, Amman - AlQasser Hotel, Amman - AlWaleed Hotel, Amman - Ammon Hotel, Amman - Fo  
araton, Kuwait City - Marriott Hotel, Kuwait - Crowne Plaza, Farwaniya - Le Verdun 4 Points, Beirut - Bellevue Hotel, Beirut - Cadmos Hotel, Beirut - Holiday Tower  
el, Muscat - Grant Hyatt Hotel, Muscat - Jacer Palace InterContinental Hotel, Bethlem - Intercontinental Hotel, Doha - Holiday Inn, Riyadh - Intercontinental Hot  
sons Hotel, Damasco - Le Meridien Hotel, Damasco - Sheraton Aleppo, Aleppo - Coral Beach Hotel, Sharjah - Rotana Tower Hotel, Dubai - Crowne Plaza Hotel, Dub  
ai - May Flower Hotel, Deira - Khalidya Palace, Deira - Marcopolo Hotel, Deira - St. George Hotel, Deira - Renaissance Hotel, Deira - Grand Hyatt Hotel, Bur Du  
naissance Hotel, Bruxelles - Palm Beach Hotel, Larnaca - Alexander The Great Beach Hotel, Paphos - Elysium Mediterranean Beach Resort, Paphos - Cypria Ma  
el Le Dannege, Megeve - Marriott Courtyard, Neuilly - Eurodisney Explorers Hotel, Paris - Hotel Scribe, Paris - Marriott Hotel Viceroy, Paris Champs Elysées - H  
naissance Hotel, München - Zafolia Hotel, Atene - Kernos Hotel, Crete - Elies Hotel, Kalymnos - Grecotel Corfu Imperial, Kommeno Corfu - Mitsis Summer Hot  
apest - Pelikan Hotel, Budapest - Wien Hotel, Budapest - Palace Hotel, Heviz - Killarney Towers Hotel, Killarney - Hotel Royal Carlton, Bologna - Four Points by She  
nze - Hotel Gabriele D'Annunzio, Firenze - Hotel Mediterraneo, Firenze - President Hotel, Forte dei Marmi - Raffaelli Park Hotel, Forte dei Marmi - Colonna Ho  
el, Palermo - Class Hotel Gariga di Podenzano, Piacenza - Club Med Napitia, Pizzo Calabro - Hotel Splendido, Portofino - Gallia Palace Hotel, Punta Ala - Hotel Da  
el Rome, Roma - Westin Excelsior, Roma - Auditorium Renzo Piano, Roma - Grand Hotel Miramare, S. Margherita Ligure - Hotel Mercure Catullo, S.Martino Buo  
ans - Britannia Rica Hotel, Trondheim - Marriott Warsaw Hotel, Warsaw - Radisson Hotel, Wroclaw - Sofitel Vilalara, Algarve - Salinas Park Hotel, Algarve - Hotel  
ia Alicante, Alicante - Hotel Diana, Arinsal, Andorra - Hotusa Hotel Ciutat de Barberà, Barberà del Vallés - Catalonia Hotel Verdi, Barcelona - Catalonia Hotel S  
almadena Costa - Hotel Bali, Benalmadena Costa - Parador Nac. Benicarlo, Benicarlo, Castellon - Grand Hotel Bali, Benidorm - Hotel Levante Club, Benidorm,  
alahorra, Calahorra, La Roja - Catalonia Hotel Punta del Rey, Calettilas, Tenerife - Hotel Melia Cambrils, Cambrils (Tarragona) - Hotel Bel-Air, Castelldefels - Hotusa  
nlabrada, Fuenlabrada - Hotel Cristal Beach, Fuerteventura - Best Western Gran Hotel Reyman, Gerona - Jet Hotel Getafe, Getafe - Fiesta Hotel Canarias Playa, G  
cha, Madrid - Silken Hotel Puerta de Europa, Madrid - MVCI, Marbella - Riu Hotel Palace Meloneras, Maspalomas, Gran Canaria - Sienassan Hotel Playa Melor  
el Alcudia Park, Puerto de Alcudia, Mallorca - Balneario Benito, Reolid, Albacete - Prestige Hotel Coral Platja, Roses, Girona - Hotel Terrassa, Roses, Girona - Ca  
ro Alcantara - Catalonia Hotel Saqnt Boi, Sant Boi - Silken Hotel Coliseum, Santander - Parador de Santillana, Santillana, Santander - Hotel Vila Tarraco, Tarrag  
on Hotel, Cobham - Holiday Inn, Manchester - Novotel Southwark, London - Wychwood Park Hotel, Weston, Crewe - Patra Jasa Hotel, Bali - Westin Hotel, Kuala  
ombo - Chiva-Som Resort, Hua-Hin - Hotel International Alger, Alger - Hilton Hotel, Ras Sudr - JW Marriott, Cairo - Luxor Village, Luxor - Novotel, Sharm El Sheikh  
rba - Club Med Djerba La Fidèle, Djerba - Club Med Nabeul Tunisie, Nabeul - Hotel Dahlia Dar Jerba, Djerba - Hotel Kantara, Tunis - Hotel Melia Mouradi, Har  
lanade Hotel, Marianske Lazne - Holiday Inn, Praha - Club Med Corgèse, Corgèse, Corsica - Sofitel Antigone, Montpellier - Melia Hotel Alexander, Paris - Melia H  
valier, Serre Chevalier - Grand hôtel Saint Jean de Luz, St Jean de Luz - Hotel Le Meridien, München - Hotel Neptune, Kos - Hotel Mediterranean, Rodi - Marri  
ogna - Club Med Cervinia, Cervinia - Starhotel Michelangelo, Firenze - Hotel La Fortezza, Firenze - Hotel De Rosa Palace, Firenze - Holiday Inn Marghera, Margh  
on, Roma - Ludovisi Palace, Roma - Club Med Sestrière, Sestrière - Hotel President, Viareggio - Riviera Resort, Marfa - Sea Bank Hotel, Mellieha - Corinthia M  
saw - Hotel Quinta do Loredo, Agueda - Hotel Sol e Mar, Albufeira - Aparthotel Marina de Albufeira, Albufeira - Hotel Praia-Mar, Carcavelos - Hotel Montemar, Fur  
otel Hotel, Moscow - Kempinski Hotel Baltschug I e II, Moscow - Renaissance Intur, Moscow - Radisson Hotel, Orebro - Concorde First Hotel Amaranten, Stock  
otland - 1 Devonshire Gardens, Glasgow, Scotland - Nexus Dalhousie Castle Hotel, Gorebridge, Scotland - Hotel Melia White House, London - Golf View Hotel, Na  
v Hotel, Brisbane - New Manly Esplanade Hotel, Sydney - Old Sydney Park Royal Hotel, Sydney - Powerhouse Boutique Hotel, Brisbane - Hotel Le Royal, Phnom  
el Leela Venture, Mumbai - Hyatt Hotel, Bali - Le Meridien Nirwana Resort, Bali - Atlet Century Park Hotel, Jakarta - Bali Camp Hotel, Bali - Biak Beach Hotel, Ma  
jarmasin - Miramar Hotel, Surabaya - Nawarat Hotel, Batam - Polepak Toraja Hotel, South Sulawesi - Puri Kamandalu Hotel, Ubud, Bali - Saba Village, Bali - Sant  
za, Subang Jaya - Hyatt Saujana, Subang Jaya - Pan Pacific Melaka, Melaka - Radisson Hotel, Langkawi - Beachcomber Hotel, Penang - Crystal Crown Hotel, Kua  
ang - Nikko Hotel, Penang - Royal Rhiga Lake, Miri - Setubong Hotel, Kuching - Swiss Garden Hotel, Kuantan - Telok Datai Golf Resort, - Tioman Island Resort, T  
church - Central Hotel, Christchurch - Lakefront Hotel, Queenstown - Logan Park Kingsgate Hotel, Auckland - Millbrook Resort, Queenstown - Park Royal Gar  
stang Lorong 16 - Airport Garden Hotel, Colombo - Hotel Lodge, Colombo - Jetwing Hotel, Colombo - Lanka Oberoi Hotel, Colombo - Tangerine Beach Hotel, Kua  
el, Bangkok - Pranang Bay Resort, Krabi - JW Marriott Mirage Hotel, Cairo - Moevenpick Nabateen Castle Hotel, Petra - Nawaffleh Village, Petra - Four Seasons  
ut - Bal El Behar Hotel, Tripoli - Corinthia Hotel Tripoli, Tripoli - Hotel "Fram" Les Idrissides, Marrakech - Hotel Diwan Sofitel Marrakech Plaza, Marrakech - Hotel H  
rakech - Hotel Royal D'Anfa, Casablanca - Hotel Sofitel, Casablanca - Ramada Hotel, Muscat - The Plantation Club, Mahe - El-Mouradi Hotel, Hammamet - Hotel I  
el, Praha - Hôtel Carlton, Cannes - Evian Royal Resort, Evian - Hotel Sofitel, Marseille - West End Hilton, Budapest - Art Park Plaza Hotel, Budapest - Grand Hotel  
Hotel Mazzarò Sea Palace, Taormina - Hotel San Domenico, Taormina - Sheraton Hotel, Warsaw - Residencial do Alboi, Aveiro - Hotel Jardins d'Ajuda, Funchal M  
bourne - Hilton Hotel, Adelaide - Hilton Melbourne Airport Hotel, Melbourne - Regent Hotel, Melbourne - Sheraton on the Park, Melbourne - Parklane Hotel, Sy  
n/oon - St. Regis Hotel, Shanghai - Westin Hotel, Macau -Peninsula International Hotel, Suva - Four Seasons Hotel, West Java - Kempinski Hotel Plaza, Jakarta -  
use Galleria Milano - Grand Hotel Mantegna Padova - Sol Melia Hotel Poltu Quatu (Sardegna) - ITI Colonna Beach Hotel Resort Porto Cervo - Thon Hotel Are

...a, Madrid - Rocco Forte Hotel Richmond, Geneva - Kempinski Hotel, Hurgada - Moevenpick Hotel, Iaba - Holiday Inn Almaty, Almaty - Crowne Plaza, ...  
...e, Aix'En Provence - Radisson SAS Style Hotel, Vienna - Park Inn Hotel, Liège - Hotel Eden Rovinj, Rovinj - Hotel Meridien Split, Spalato - Hotel Albatros, - Sunwing Ho  
...né, Saint En Provence - Hotel Embassy, Cannes - Marriott Hotel Saint Jacques, Paris - Club Med La Plaigne 2100, La Plaigne - Sofitel Lyon Bellecour, Lyon - Club M  
...Rome, Berlin - Hotel Zur Quelle, Colonia - Maritim Hotel Duesseldorf, Duesseldorf - Arcotel Hamburg, Hamburg - Rocco Forte Hotel, Muenchen - Arcotel Stuttg  
...e Village, Crete - Grecotel Rithymna Beach, Crete - Hotel Katsoulakis, N.Ionia-Athens - Aldemar Paradise Village, Rodos - Danubius Hotel Astoria, Budapest - Bos  
...Meath - Crowne Plaza, Caserta - Hotel Saint Gobain, Caserta - Class Hotel, Caserta - Sheraton Hotel, Catania - Hotel Al Pescatore, Gallipoli - VentaClub Borgo F  
...mo - Hilton Excelsior Palace, Palermo - Hilton Hotel Villa Igeia, Palermo - Hotel Galilei, Pisa - Sol Melia Poltu Quatu, Poltu Quatu (Sardegna) - Hotel Selene, Pome  
...h Inn Rome airport, Rome - Holiday Inn Siracusa, Siracusa - Golden Tulip Ianua Hotel, Valenza Po - ATA Hotel Tanka Village Resort, Villasimius - Corinthia San G  
...St. Petersburg, Moscow - Danubius Hotel Postyten Terminal Hotel, Postyén - Hilton Hotel Geneva, Geneva - Donghu Hotel, Shanghai - Today Hotel Gurgaon, Gurga  
...Hotel Polus Palace, Hurghada - Sahl Hashish - Moevenpick Aswan, Aswan - Sonesta floating Hotel. - Safir Hotel, Cairo - El Zamalek - Mena House Oberoi Hotel Ca  
...continental Hotel, Amman - Sheraton Hotel, Kuwait - Shajarah Hotel, Tripoli - Club Med Albion, Albion - Club Med Palmeraie Marrakech, Marrakech - Sofitel  
...Hotel B Burj Dubai, Dubai - Hotel Barcelò, Cancun - Hotel International Zagabria, Zagabria - Saint Rafael Hotel, Limassol - Four Seasons Hotel Limassol, Limassol - H  
...Hotel Espace Bollaert, Lens - Holiday Inn Park & Suites, Paris - Hotel Royal Riviera, St.Jean Cap Ferrat - Best Western Hotel La Magnaneraie, Villeneuve Les Avig  
...kira / Corfu - Grecotel Olympia Riviera Hotel, Pargos - Hotel Calypso Palace, Rhodes - Aldemar Hotel Paradise Royal Mare, Rhodes - Hotel Porto Palace, Salonici  
...dia) - Villaggio Marina dei Ginepri, Marina di Sorso (Sassari) - Steigenberger Hotel Therme Meran, Merano - Hotel Acacia, Palermo - Hotel Villa Paradiso, Passign  
...Grand Hotel Colonna Capo testa, S.Teresa di Gallura - THI Golden Palace Hotel, Torino - Hilton Molino Stucky, Venezia - Domina Plaza Hotel, Riga - Radisson Goe  
...al - Hilton Diagonal Mar, Barcelona - Sheraton Hotel, Ankara - Side Perissia Hotel, Antalya - Kempinski Barbaros Bay Resort & Spa, Bordon - Ramada Hotel Mi  
...Media City, Cairo - Sofitel Sphinx, Cairo - Hilton Long Beach, Hurgada - Hilton Nuweiba Coral Resort, Nuweiba - Baron Hotel Sharm el Sheikh - Hilton Nel  
...Le Meridien Eko, Lagos - Sofitel Lagos Extension, Lagos - Sun Hotel & Casino, Bloemfontein - Club Med Hammamet, Hammamet - Hotel Les Oliviers, Tunis - Gr  
...duque, Adeje/Tenerife - Hilton Hotel Imperial, Dubrovnik - Regent Esplanade Zagreb, Zagabria - Mvci Romainvilliers, Paris - Express by Holiday Inn, Berlin - Cer  
...Hotel Polus Palace, Dunavarsany - Hotel Carbona, Héviz - Le Meridien Hotel Azúr, Siófok - Hotel Claudius, Szombathely - Hotel Afrodita, Tucepi - Radisson Hotel, S  
...Firenze - Una Hotel Malpensa, Legnano - Bulgari Hotel, Milano - IGV Hotel Baia Samuele, Punta Sampieri (RG) - Domina Genius Hotel Malpensa, Somma Lomba  
...Hotel, Lisboa - Sana Malhoa Park Hotel, Malhoa - Howard Johnson Grand Plaza Hotel, Bucharest - Radisson Hotel Kiev, Kiev - Marriott Hotel Viceroy, Hyderab  
...erjaya Pulau Redang, Terengganu - Riverina Hotel Beruwela, Beruwela - Hilton Hotel Alger, Alger - Sheraton Hotel, Alger - Baron Hotel Cairo, Cairo - Heliopolis - H  
...wait - Marriott Hotel, Kuwait - Hilton Plaza Hotel, Kuwait - Club Med Palmeraie, Marrakech - Shangri-La Bar Al Jissah Resort, Muscat - Moevenpick Hotel, Alkha  
...Hotel Jalisca, Vallata - Fiesta Bávaro, Santo Domingo - Hilton Santo Spirito, Miami - Marriott Hotel, Yerevan - Robinson Club, Cala D'ór - Hotel Riu Chiclana, Chicla  
...Tenerife - Hotel Cristal Beach, Fuerteventura - Meteor Hotel, Makarska - Grecian Bay Hotel, Ayia Napa - Al-Diana Hotel, Cyprus - Hotel Imperial, Karlovy Vary - Hi  
...villiers - Express by Holiday Inn, Grenoble - Inter Hotel Atrium, Limoges - Marriott Courtyard, Neuilly s/Seine - Marriott Courtyard, Paris - Marriott Paris, Paris - M  
...ck - Grecotel King George, Athens - White Rocks Hotel, Cefalonia - Marina Hotel Greece, Crete - Helios Elounda Beach Hotel, Crete - Perrakis Hotel, Isola di And  
...ub Village Maritalia, Baia di Peschici - UNA Hotel Bologna, Bologna - Holiday Inn, Cagliari - Holiday Inn, Cosenza - Relais Chateaux L'Albereta, Erbusco, Brescia -  
...an Michele, Monte Sant'Angelo - Holiday Inn, Palermo - Ambasciatori Hotel, Rimini - Maritalia Hotel Mandarin, Rodi Garganico - Grand Hotel delle Terme, Scia  
...Andorra - Hotel Andorra Center, Andorra - Hotel Magic Andorra, Andorra - Hotel Encamp, Andorra - Hotusa Hotel Palacio Valderabanos, Avila - Hotusa Hotel Villa  
...lla - Meliá Don Pepe, Marbella - Paradores Hotel Reconquista, Oviedo - NH Hotel Oriol, Portuguese - Parador Puente Riesgo, Puente Riesgo - Meliá Puerto R  
...el Santander, Santander - Parador Nacional Limpías, Santander - Vinci Hotel Puerto Chico, Santander - Vinci Hotel La Rábida, Sevilla - Las Roques Hotel, Tener  
...Express by Holiday Inn, Geneva - Oasis Paraiso, Costa Adeje - Fiesta Paraiso Floral, Costa Adeje - Sheraton Hotel, Ankara - Dohnveli Beach Project, Male - Meric  
...mpick Hotel, Petra - Panorama Hotel, Petra - Petra Palace Hotel, Petra - Taybet Zaman Village, Petra - Aqaba Castle Hotel, Aqaba - Aqaba Gulf Hotel, Aqaba - Holi  
...orte Grand Hotel, Amman - Qaser Qortoba, Amman - Rama Hotel, Amman - Red Rose Hotel, Amman - New Park Hotel, Salmiya - Hilton Hotel, Mangaf - Four Po  
...r Hotel, Beirut - Printania Hotel, Beirut - Riviera Hotel, Beirut - Hotel Atlas Medina, Marrakech - Sheraton Hotel, Casablanca - Holiday Inn, Salalah - Intercontine  
...el, Jeddah - Ritz Carlton Al Moaibed, Alkhubar - Le Meridien Fisherman's Cove Hotel, Seychelles - Sheraton Hotel, Damascus - Fardoss Tower M., Damascus - F  
...Dubai - Shangri-La Hotel, Dubai - Hilton Hotel, Jumeirah Beach - Sheraton Jumeirah Beach Hotel, Jumeirah - Jebel Ali Hotel, Jebel Ali - Vendome Plaza Hotel Du  
...bai - Ramada Hotel, Bur Dubai - Ascot Hotel, Bur Dubai - Ab Far Hotel, Al Mulla - Crowne Plaza Hotel, Abu Dhabi - Holiday Inn Abu Dhabi, Abu Dhabi - Le Parna  
...otel, Paphos - Grecian Park Hotel, Paralimni - Joseph Hotel, Praha - Hotel Baroco, Praha - Hapimag Hotel, Praha - ABC Hotel, Praha - Express by Holiday Inn, Arr  
...Hotel DomAquaree, Berlin - Marriott Courtyard, Berlin Koenig - Marriott Courtyard, Bochum am Stadtpark - Renaissance Hotel, Koln - Marriott Hotel, Münch  
...l, Rhodes - Mitsis Rodos Village, Rhodes - Chevaliers Hotel, Rhodes - Hotel Carbona, Balaton - Corinthia Grand Hotel Royal, Budapest - Novotel Budapest Centr  
...eraton, Bolzano - Hotel Parco degli Aragonesi, Catania - Hotel Villa D'Este, Cernobbio - Boscolo Astoria Hotel, Firenze - Holiday Inn Firenze, Firenze - Hotel La Forte  
...Hotel Du Golf, Golfo di Cugnana, Olbia - Medusa Hotel, Lampedusa - Boston Resort, Livorno - Holiday Inn, Mestre - Aeroviaggi Hotel, Palermo - Fiesta Garden Be  
...Filié, Querceta di Seravezza, Lucca - Grand Hotel San Marino, Repubblica San Marino - Boscolo Grand Hotel Palace, Roma - Class Hotel Fast Hotel, Roma - Merc  
...n Alberg, Verona - Express by Holiday Inn, Senigallia - Class Hotel, Terni - Hotel President, Viareggio - La Salita Antonini Hotel, Mellieha - Intercontinental Hotel  
...Holiday Inn, Ponta Delgada Açores - Aquarus Hotel, Moscow - Renaissance Samara Hotel, Samara - Marriott Hotel, St. Petersburg - Hotel Paraiso, Adeje, Tener  
...abadell, Barcelona - Catalonia Hotel Berna, Barcelona - Gran Hotel Benahavis, Benahavis - Best Western Hotel Siroco, Benalmadena - Gran Hotel Costa Del  
...Alicante - Hotel Ercilla, Bilbao - Vizcaya - Hotel Puente Colgante, Bilbao - Hotel Domine, Bilbao - Hotel Puerto Bahía, Cadiz - Hotel Los Jandalos, Cadiz - Parado  
...a Hotel Maimonides, Cordoba - Hotel Los Jardines, Cordoba - Apart-Hotel Coruna, Coruna - Marriott Hotel, Denia - Hotel Nordic, El Tarter-Canillo, Andorra - Jet H  
...Gran Canaria - Hotel Vilas, Ibiza - Hotel Los Molinos, Ibiza - Hotel Las Gavias, Las Americas, Tenerife - Pineros Hotel La Nina, Las Americas, Tenerife - Catalonia H  
...neras, Maspalomas, Gran Canaria - Hotel El Bosque, Matalpino, Madrid - Apart-Hotel Oviedo, Oviedo - Iberostar Hotel Playa de Muro, Puerto de Alcudia, Mallor  
...CataloniaHotel Pasaje, Salamanca - Best Western Hotel Los Angeles, Salou, Tarragona - Best Western Aparthotel Michelangelo, Salou, Tarragona - Hotel Alcotan  
...gona - Hotel Bahia Principe, Tenerife - Radisson Hotel SAS Strand, Stockholm - Hotel Diplomat, Stockholm - Scandic Hotel, Stockholm - Kempinski Hotel, St. Mo  
...Lumpur - Pelangi Beach Resort, Langkawi - Trekkers Hotel, Wellington - Palm Grove Village, Singapore - Elephant Corridor Resort, Sigiriya - Hyde Park Residen  
... - Leisure Hill, Dbayeh - Rosa Center, Brumana - Hotel Royal Mirage, Marrakech - Moulay Yacoub Resort, Fes - Ste Anne Resort, Mahe - Club Med Djerba La Dou  
...mmamet - Hotel Phenicia, Hammamet - Metropolitan Beach Hotel, Dubai - Ani Hotel, Yerevan - Arma Hotel, Yerevan - The Golden Tulip Carlton Hotel, Antwerp  
...Hotel Royal Alma, Paris - Melia Hotel Colbert, Paris - Melia Hotel Madeleine, Paris - Sofitel Forum Rive Gauche, Paris - Courtyard by Marriott, Roissy - Club Med Sa  
...ott Hotel, Budapest - Thermal Hotel, Budapest - Andrassy Hotel, Budapest - Normafa Hotel, Budapest - Kehida Thermal Kehida Kustany, Budapest - Carlton Ho  
...era - Residence Hotel Il Valentino, Marina di Castellaneta - Hotel Melia Milan, Milan - Hotel Le Palme, Milano Marittima - Hotel De Londres, Rimini - Hotel Cava  
...istra Village, St. Pauls Bay - San Antonio Hotel, St. Pauls Bay - Hilton Hotel, Cracow - Best Western Mazurkas Travel, Varsavia - Hilton Hotel, Warsaw - Hyatt Ho  
...nchal Madeira - Hotel Baia do Sol, Funchal Madeira - Paulo's Hotel, Guarda - Marina Club Aparthotel, Lagos - Hotel Infante de Sagres, Porto - Hoteis do Rio, Setu  
...nholm - Hotel Winn, Stockholm - Hotel J, Stockholm - The Ritz Carlton Hotel, Istanbul - Westerwood Hotel, Cumbernauld, Scotland - Crowne Plaza Hotel, Edinbu  
...airn, Scotland - De Vere Slayley Hall, Newcastle - Pamela Hilton Hotel, Perth - Radisson Hotel, Sydney - Regent Hotel, Sydney - Sheraton Airport Hotel, Sydney -  
...Penh - Shangri-La Pudong, Shanghai - Hainan Mandarin, Haikou, Hainan - Turtle Island Resort, Yasawa - Hilton Hotel, Guam - Emperor Byron Hotel, Happy Vall  
...arauw, Irian Jaya - Boutique Hotel, Jakarta - Carita Beach Hotel, Cilegon - Dusit Inn Hotel, Balikpapan - Graha Santika Hotel, Semarang - Jungjung Buih Plaza Ho  
...nika Hotel, Yogyakarta - Senayan Golf Club, Jakarta - Sengiggi Beach Hotel, Lombok - Sentra Buana Hotel, Jakarta - Travel Hotel, Jakarta - Hilton Hotel, Seoul - Crow  
...la Lumpur - Fairmount Hotel, Kuala Lumpur - International Equestrian & Country Resort, Kuala Lumpur - Riverside Crowne Plaza Hotel, Kuching - Leisure Bay Ho  
...Tioman Island - CDL Millennium Hotel, Queenstown - CDL Millennium Hotel, Rotorua - Quality Hotel, Christchurch - Travel Lodge, Auckland - Cathedral Square Ho  
...rdens, Christchurch - Shotover Resort, Queenstown - Waipuna Hotel, Auckland - Marriott Islamabad Hotel, Islamabad - Shangri-La Hotel, Garden Wing - Hotel  
...ultara - Hua Hin Sheraton Hotel, Bangkok - Sofitel Raja Orchid Khon Kaen Hotel, Bangkok - Boulevard Hotel, Amari - Imperial Mae-Ping, Chiangmai - Plaza Ath  
...Hotel, Amman - Beirut International Hotel, Amman - Hilton Hotel, Kuwait - Mouawad Village, Brumana - Al-Sheick Hotel, Bhamdoun - Sheraton Coral Beach Ho  
...Hyatt Regency, Casablanca - Hotel Kenzi, Marrakech - Kempinski Hotel Mansour Eddahbi, Marrakech - Hotel Mercure Les Almohades, Tanger - Hotel Meridien N  
...ar Ismail, Tunis - Hotel Osiris, Djerba - Turkmenbashy Hotel, Turkmenbashy - Grand Hyatt Hotel, Dubai - Holiday Inn, Limassol - Le Meridien, Limassol - Renaissa  
...el del Mare, Bordighera - Starhotel Monginevro, Firenze - Sheraton Hotel, Genova - Holiday Inn, Modena - Grand Hotel Terme, Riolo - Holiday Inn Rome West, Ro  
...Madeira - Hotel São João, Funchal Madeira - Marriott Grand Hotel, Bucharest - Taksim Hotel, Istanbul - Great Western Royal Hotel, London - Four Seasons Ho  
...ydney - Grand Hotel D'Angkor, Siem Reap - Monorom Holiday Villa, Phnom Penh - New World Courtyard, Shunde - Hotel Renaissance, Kowloon - Shangri-La Ho  
...Kolybia Beach Hotel, Rodos - Hotel Lindos Princess, Rodos - Hotel Olympian Bay, - Mercure Hotel City Center, Budapest - Hotel Airone, Corigliano Calabro - Ho  
...na Oslo - Ramada Tourist Hotel, Bucharest - Hotel Vinci Gran Via, Madrid - Rocco Forte Hotel Richmond, Geneva - Kempinski Hotel, Hurgada - Moevennick Ho

# HOTELLERIE

## HOTELLERIE

IT Hotellerie, rinomata in tutto il mondo, è la gamma più completa di accessori per i bagni degli hotel. Il design lineare e la facilità di installazione, combinati con l'elevata qualità della nostra cromatura, hanno soddisfatto nel tempo e continuano a soddisfare le più alte aspettative.

EN Hotellerie, worldwide renowned, is the most complete range of hotel bathroom accessories. The linear design and the easy installation, combined with the excellent quality of our chrome finishing, have satisfied in the time and continue to satisfy the highest expectations.

FR Hotellerie, renommée dans le monde entier, est la gamme plus complète d'accessoires de salle de bains, spécialement conçue pour les hôtels. Son design linéaire et sa facilité d'installation, alliés à un chromage de haute qualité, ont satisfait et continue à satisfaire nos clients les plus exigeants.

ES Hotellerie, de fama mundial, es la gama más completa de accesorios para los cuartos de baño de hoteles. Su diseño lineal y la fácil instalación, unida a la alta calidad de nuestros cromados, han satisfecho y continúan satisfaciendo a la clientela más exigente.





## HOTELLERIE

## AV190

Portasalviette  
Towel holder  
Porte-serviettes  
Toallero

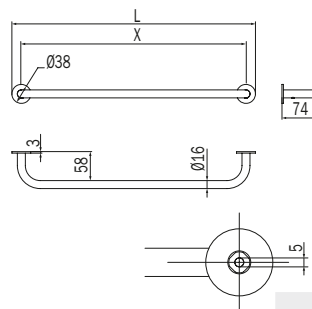

click

				CR	NE WM	AC	BZ OR	CG	DR
<b>cod.</b>	<b>L</b>	<b>X</b>	<b>pz.</b>	€	€	€	€	€	€
<b>AV190A ...</b>	<b>338</b>	<b>300</b>	<b>1</b>	42,80	49,40	55,40	69,40	58,60	62,90
<b>AV190B ...</b>	<b>488</b>	<b>450</b>	<b>1</b>	48,50	56,50	62,90	78,10	66,20	71,50
<b>AV190C ...</b>	<b>638</b>	<b>600</b>	<b>1</b>	51,40	59,70	66,20	82,30	69,40	75,90

## A0418

Portasalviette. 007: confezione da 10 pz.  
Towel holder. 007: the packing contains 10 pcs.  
Porte-serviettes. 007: lot de 10 pz.  
Toallero. 007: paquete de 10 piezas

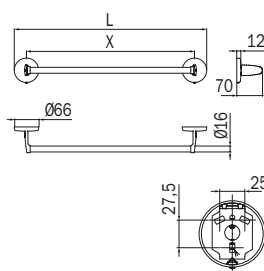

				CR	CR 007
<b>cod.</b>	<b>L</b>	<b>X</b>	<b>pz.</b>	€	€
<b>A0418A ...</b>	<b>370</b>	<b>304</b>	<b>1</b>	45,00	41,60
<b>A0418B ...</b>	<b>520</b>	<b>454</b>	<b>1</b>	47,50	44,10
<b>A0418C ...</b>	<b>670</b>	<b>604</b>	<b>1</b>	50,20	46,50

## A0494

Portasalviette. 007: confezione da 10 pz.  
Towel holder. 007: the packing contains 10 pcs.  
Porte-serviettes. 007: lot de 10 pz.  
Toallero. 007: paquete de 10 piezas

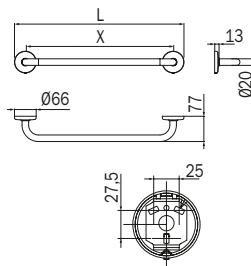

				CR	CR 007
<b>cod.</b>	<b>L</b>	<b>X</b>	<b>pz.</b>	€	€
<b>A0494A ...</b>	<b>370</b>	<b>304</b>	<b>1</b>	47,00	43,60
<b>A0494B ...</b>	<b>520</b>	<b>454</b>	<b>1</b>	53,80	49,80
<b>A0494C ...</b>	<b>670</b>	<b>604</b>	<b>1</b>	63,90	58,60
<b>A0494D ...</b>	<b>870</b>	<b>804</b>	<b>1</b>	74,70	



**A0415A**

NEW

Portasalviette fisso a bandiera  
Fixed towel holder  
Porte-serviettes fixe à drapeau  
Toallero fijo a bandera

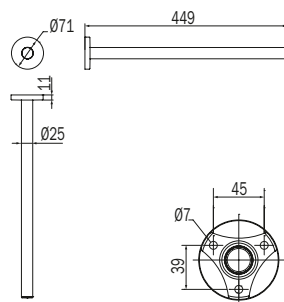

		CR	WM NE	AC CG	DR OR	BZ
cod.	pz.	€	€	€	€	€
A0415A ...	1	38,50	46,70	54,20	62,90	

**A04160**

Portasalviette ad anello. 007: confezione da 10 pz.  
Ring towel holder. 007: the packing contains 10 pcs.  
Porte-serviette anneau. 007: lot de 10 pz.  
Toallero de aro. 007: paquete de 10 piezas

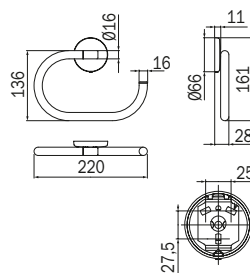

		CR	CR 007
cod.	pz.	€	€
A04160 ...	1	52,00	47,00

**A0467N**

Portasalviette a ripiani  
Shelved towel holder  
Rack porte-serviettes  
Toallero repisa

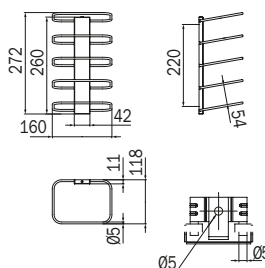

		CR
cod.	pz.	€
A0467N ...	1	73,70

## HOTELLERIE

**A3395J**

Portasalviette interno ed esterno per parete doccia  
 Internal and external towel holder for shower enclosure  
 Porte-serviette intérieur et extérieur pour parois de douche  
 Toallero interior y exterior para paredes de ducha

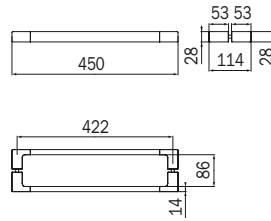

		CR
cod.	pz.	€
A3395J ...	1	208,90

**A3395K**

Portasalviette esterno per pareti doccia  
 External towel holder for shower enclosure  
 Porte-serviette extérieur pour parois de douche  
 Toallero exterior para paredes de ducha

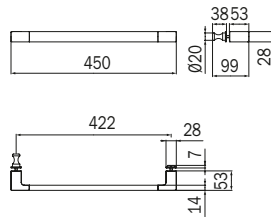

		CR
cod.	pz.	€
A3395K ...	1	161,30

**A4618J**

Portasalviette interno ed esterno per parete doccia  
 Internal and external towel holder for shower enclosure  
 Porte-serviette intérieur et extérieur pour parois de douche  
 Toallero interior y exterior para paredes de ducha

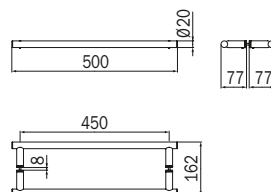

		CR
cod.	pz.	€
A4618J ...	1	125,60

**A4618K**

Portasalviette esterno per pareti doccia  
 External towel holder for shower enclosure  
 Porte-serviette extérieur pour parois de douche  
 Toallero exterior para paredes de ducha

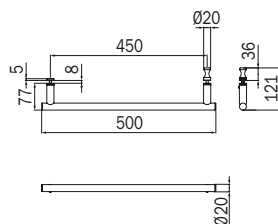

		CR
cod.	pz.	€
A4618K ...	1	85,50

**AV120A**

Appendiabiti  
 Clothes hanger  
 Patère  
 Percha

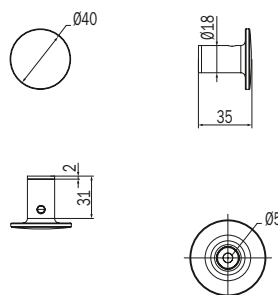

		CR	NE WM	AC	BZ DR	CG OR
cod.	pz.	€	€	€	€	€
AV120A ...	1	24,60	28,20	34,50	39,10	44,30

click

**AV120E**

NEW

Appendiabiti doppio  
 Double clothes hanger  
 Patère double  
 Percha doble

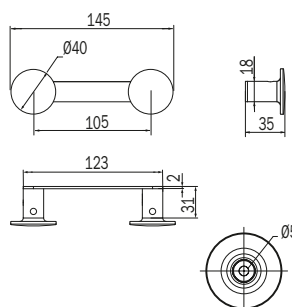

		CR	NE WM	AC	BZ DR	CG OR
cod.	pz.	€	€	€	€	€
AV120E ...	1	55,60	64,00	77,80	88,90	100,00

click

## HOTELLERIE

## AV120B

Appendiabiti doppio  
Double clothes hanger  
Patère double  
Percha doble

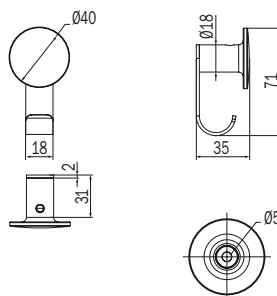

click

cod.	pz.	CR	NE	WM	AC	BZ	DR	CG	OR
		€	€	€	€	€	€		
AV120B ...	1	33,00	38,00	46,30	56,50	59,50			

## AV120C

Appendiabiti triplo  
Triple clothes hanger  
Patère triple  
Percha triple

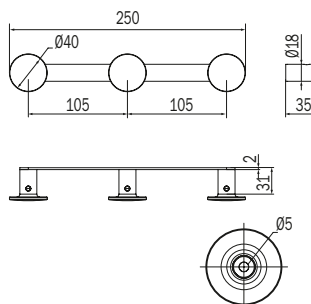

click

cod.	pz.	CR	NE	WM	AC	BZ	DR	CG	OR
		€	€	€	€	€	€		
AV120C ...	1	56,50	65,00	79,10	93,20	101,80			

## AV120D

Appendiabiti quadruplo  
Quadruple clothes hanger  
Patère quadruple  
Percha cuádruple

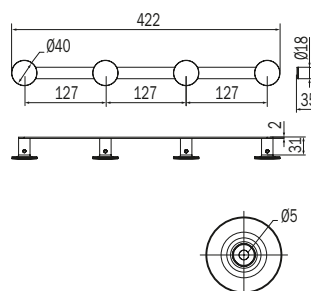
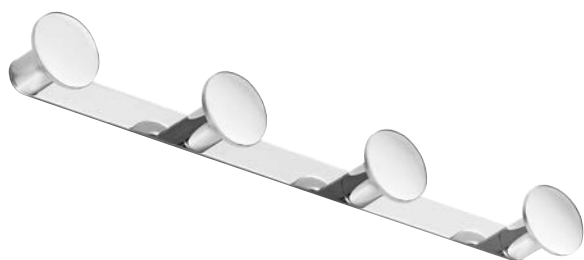

click

cod.	pz.	CR	NE	WM	AC	BZ	DR	CG	OR
		€	€	€	€	€	€		
AV120D ...	1	81,30	94,30	113,90	129,90	146,40			

**A05620**

Appendiabiti. 003: confezione da 5 pz.  
Clothes hanger. 003: the packing contains 5 pcs.  
Patère. 003: lot de 5 pz.  
Percha. 003: paquete de 5 piezas

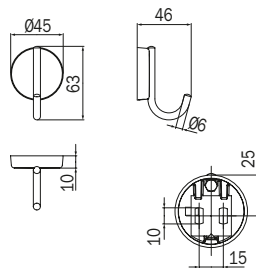

		CR 003	
cod.	pz.	€	€
A05620 ...	1	19,00	

**A23210**

Appendiabiti. 007: confezione da 10 pz.  
Clothes hanger. 007: the packing contains 10 pcs.  
Patère. 007: lot de 10 pz.  
Percha. 007: paquete de 10 piezas

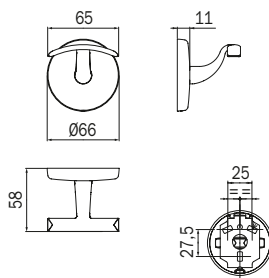

		CR		CR 007	
cod.	pz.	€	€	€	€
A23210 ...	1	23,90	22,00		

**A38210**

Appendiabiti. 007: confezione da 10 pz.  
Clothes hanger. 007: the packing contains 10 pcs.  
Patère. 007: lot de 10 pz.  
Percha. 007: paquete de 10 piezas

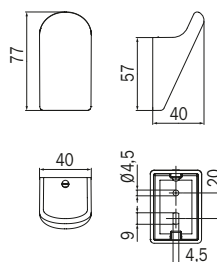

		CR		CR 007	
cod.	pz.	€	€	€	€
A38210 ...	1	30,30	26,70		

## HOTELLERIE

**AV420A**

Appendiabiti. 007: confezione da 10 pz.  
Clothes hanger. 007: the packing contains 10 pcs.  
Patère. 007: lot de 10 pz.  
Percha. 007: paquete de 10 piezas

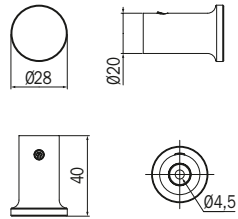

		CR 007
cod.	pz.	€
<b>AV420A ...</b>	1	17,50

**A1320A**

Appendiabiti  
Clothes hanger  
Patère  
Percha

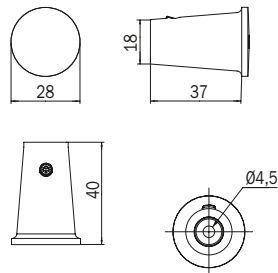

		CR
cod.	pz.	€
<b>A1320A ...</b>	1	15,80

**A1320C**

Appendiabiti doppio  
Double clothes hanger  
Patère double  
Percha doble

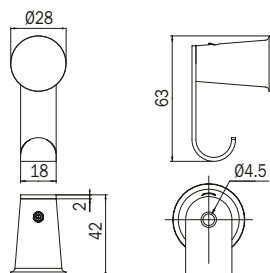

		CR
cod.	pz.	€
<b>A1320C ...</b>	1	29,00

**A05610**

Appendiabiti, 2 pz. per confezione. 007: confezione da 10 pz.  
 Clothes hanger, 2 pieces for packing. 007: the packing contains 10 pcs.  
 Patère, vendus par deux. 007: lot de 10 pz.  
 Percha, dos unidades por confección. 007: paquete de 10 piezas

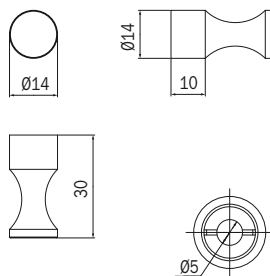

		CR		CR 007
cod.	pz.	€	€	
A05610 ...	1	14,80	13,40	

**A04210**

Appendiabiti doppio. 007: confezione da 10 pz.  
 Double clothes hanger. 007: the packing contains 10 pcs.  
 Patère double. 007: lot de 10 pz.  
 Percha doble. 007: paquete de 10 piezas

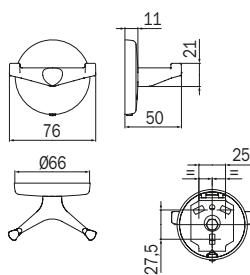

		CR		CR 007
cod.	pz.	€	€	
A04210 ...	1	19,70	18,30	

**A12252**

Appendiabiti doppio. 003: confezione da 15 pz.  
 Double clothes hanger. 003: the packing contains 15 pcs.  
 Patère double. 003: lot de 15 pz.  
 Percha doble. 003: paquete de 15 piezas

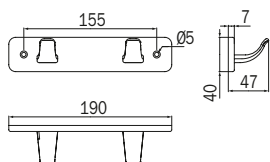

		CR 003	
cod.	pz.	€	
A12252 ...	1	26,50	

## HOTELLERIE

**A12253**

Appendiabiti tripla. 003: confezione da 15 pz.  
 Triple clothes hanger. 003: the packing contains 15 pcs.  
 Patère triple. 003: lot de 15 pz.  
 Percha triple. 003: paquete de 15 piezas

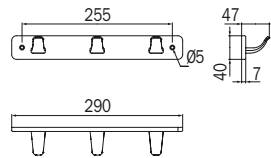

		CR 003	
cod.	pz.	€	
A12253 ...	1	31,90	

**A12254**

Appendiabiti quadruplo. 003: confezione da 15 pz.  
 Quadruple clothes hanger. 003: the packing contains 15 pcs.  
 Patère quadruple. 003: lot de 15 pz.  
 Percha cuádruple. 003: paquete de 15 piezas

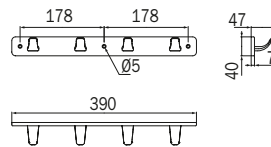

		CR 003	
cod.	pz.	€	
A12254 ...	1	45,50	

**A38240**

Appendiabiti quadruplo. 007: confezione da 10 pz.  
 Quadruple clothes hanger. 007: the packing contains 10 pcs.  
 Patère quadruple. 007: lot de 10 pz.  
 Percha cuádruple. 007: paquete de 10 piezas

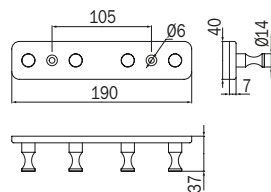

		CR		CR 007	
cod.	pz.	€	€		
A38240 ...	1	68,30	60,70		



**A04110**

Portasapone a parete con bacinella in ottone. 007: confezione da 10 pz.  
 Wall-mounted soap holder, with brass dish. 007: the packing contains 10 pcs.  
 Porte-savon mural avec coupelle en laiton. 007: lot de 10 pz.  
 Jabonera de pared con cubeta de latón. 007: paquete de 10 piezas

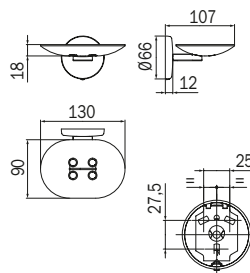

		CR		CR 007
cod.	pz.	€	€	€
A04110 ...	1	68,30	62,90	

**A0411A**

Portasapone a parete con foro, bacinella in ottone  
 Wall-mounted soap holder, with dish in brass, with hole  
 Porte-savon mural, coupelle en laiton percée  
 Jabonera de pared con cubeta de latón, con orificio

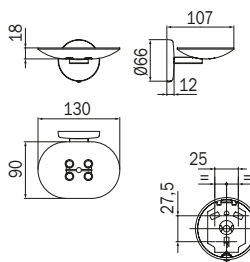

		CR	
cod.	pz.	€	€
A0411A ...	1	69,40	

**AV567A**

Spandisapone a parete a ridotta erogazione di sapone  
 Wall soap dispenser with reduced soap dispensing  
 Distributeur de savon mural avec distribution de savon réduite  
 Dosificador a pared con reducido suministro de jabón

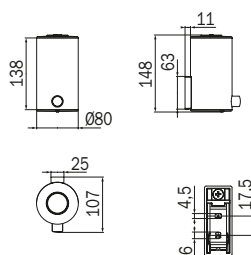

		CR	
cod.	pz.	€	€
AV567A ...	1	135,40	

0,5 Lt.

## HOTELLERIE

## A05670

Spandisapone a parete a ridotta erogazione di sapone  
 Wall soap dispenser with reduced soap dispensing  
 Distributeur de savon mural avec distribution de savon réduite  
 Dosificador a pared con reducido suministro de jabón

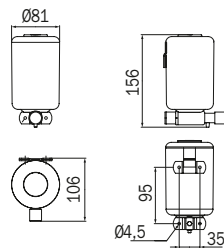

0,5 Lt.

cod.	pz.	€	CR
A05670 ...	1	92,10	

## AV1120

NEW

Spandisapone a parete in ABS, contenitore igienico in SAN trasparente  
 Wall-mounted soap dispenser in ABS, with hygienical SAN transparent container  
 Distributeur de savon mural en ABS, pot transparent hygiénique en SAN  
 Dosificador de jabón líquido de pared, de ABS, recipiente higiénico en SAN transparente

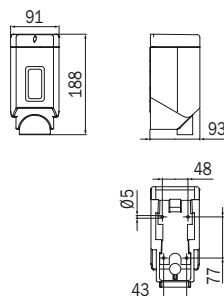

0,60 Lt.

cod.	pz.	€	CR	NE
AV1120 ...	1	67,30	78,10	

## AV112A

Spandisapone a parete in ABS, contenitori trasparenti  
 Wall-mounted soap dispenser in ABS, with transparent container  
 Distributeur de savon mural en ABS, pot transparent  
 Dosificador de jabón líquido de pared, de ABS, recipiente transparente

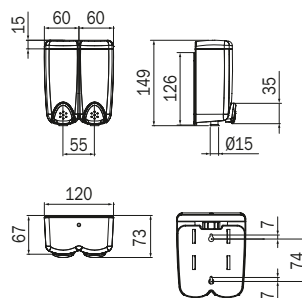
2x  
0,26 Lt.

cod.	pz.	€	CR
AV112A ...	1	36,10	

**AV467A**

Spandisapone a parete in ABS  
 Wall-mounted soap dispenser in ABS  
 Distributeur de savon mural en ABS  
 Dosificador de jabón líquido de pared, de ABS

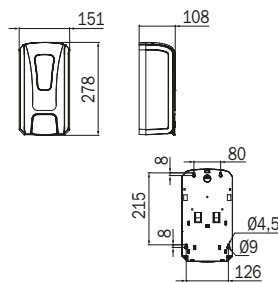

cod.	pz.	€
AV467A ...	1	40,60

NW  
 WW

**AV4670**

Spandisapone a parete in alluminio anodizzato  
 Wall-mounted soap dispenser, anodised aluminium  
 Distributeur de savon mural en aluminium anodisé  
 Dosificador de jabón líquido de pared, aluminio anodizado

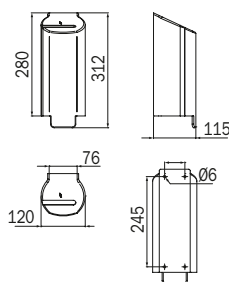

cod.	pz.	€
AV4670 ...	1	128,90

AL

**AV467B**

Spandisapone a parete elettrico per sapone liquido  
 Electronic wall-mounted soap dispenser for liquid soap  
 Distributeur de savon mural électronique pour savon liquide  
 Dispensador electrónico a pared para jabón líquido

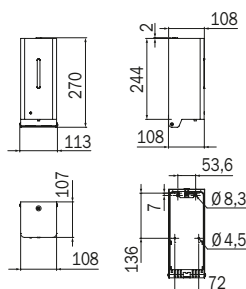

cod.	pz.	€
AV467B ...	1	306,40

AL

## HOTELLERIE

## AV467C

Spandisapone a parete elettrico per sapone a schiuma  
 Electronic wall-mounted soap dispenser for foam soap  
 Distributeur de savon mural électronique pour savon mousse  
 Dispensador electrónico a pared para jabón a espuma

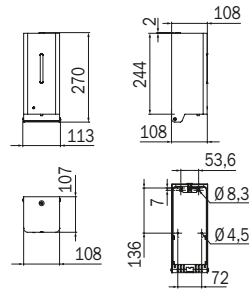

0,85 Lt.

cod.	pz.	€
AV467C ...	1	306,40

## AV467D

Spandisapone a parete elettrico per sapone in spray  
 Electrical wall-mounted soap dispenser for spray soap  
 Distributeur de savon électrique mural pour savon en spray  
 Dispensador electrónico a pared para jabón en aerosol

NEW

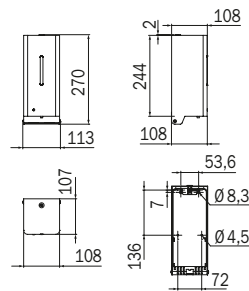

0,85 Lt.

cod.	pz.	€
AV467D ...	1	306,40

## AV467E

Spandisapone a parete elettrico per sapone liquido  
 Electronic wall-mounted soap dispenser for liquid soap  
 Distributeur de savon mural électronique pour savon liquide  
 Dispensador electrónico a pared para jabón líquido

NEW

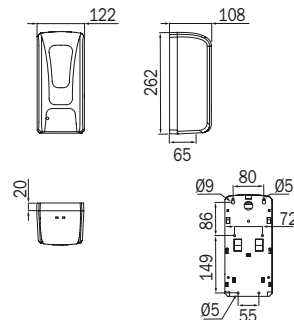

1 Lt.

cod.	pz.	€
AV467E ...	1	107,20

**AV467X**

NEW

Piantana parete/centrosala con salvagoccia per spandisapone elettrico (opzionale)  
 Wall or floor stand with drip tray for electrical soap dispenser (optional)  
 Support mural ou libre avec égouttoir pour distributeur de savon électrique (facultatif)  
 Toallero de pie /centro sala con salva gocha para dispensador de jabón eléctrico (opcional)

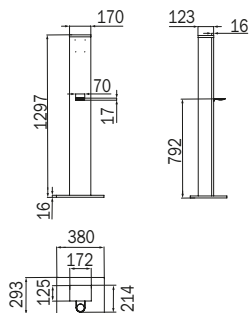

cod.	pz.	€
AV467X ...	1	139,30

**RV467E**

NEW

Collegamento a rete per spandisapone elettrico AV467E (opzionale)  
 Electric cable for soap dispenser AV467E (optional)  
 Branchement secteur pour distributeur de savon électrique AV467E (en option)  
 Conexión de red para dispensador de jabón electrónico AV467E (opcional)



cod.	pz.	€
RV467E	1	21,50

**A0407A**

Spandisapone ad incasso per top mobile  
 Built-in soap dispenser for furniture top  
 Distributeur de savon à encastrer pour plan vasque  
 Dosificador de jabón líquido encastrado para encimera

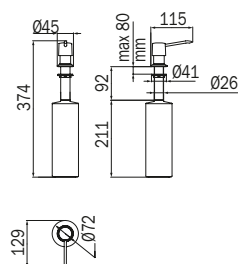

cod.	pz.	€
A0407A ...	1	60,70



0,75 Lt.

## HOTELLERIE

## A04100

Portabicchiere a parete con bicchiere in vetro extrachiario trasparente  
 Wall-mounted tumbler holder with extra clear transparent glass tumbler  
 Porte-verre mural avec verre en verre transparent extra clair  
 Portavasos de pared con vaso de vidrio transparente extraclaro

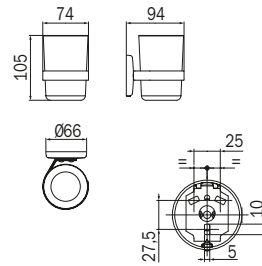

		CR 03
cod.	pz.	€
A04100 ...	1	40,70

## A0410N

Supporto a parete da completare con gli artt. R01100 - R03600. 007: confezione da 10 pz.  
 Wall-mounted support to be completed with arts R01100 - R03600. 007: the packing contains 10 pcs.  
 Support mural à compléter avec les arts, R01100 - R03600. 007: lot de 10 pz.  
 Soporte de pared, para vaso, para completar con los art. R01100 - R03600. 007: paquete de 10 piezas

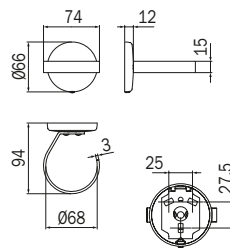

		CR 007
cod.	pz.	€
A0410N ...	1	24,20

## R03600

Bicchiere in vetro extrachiario trasparente per artt. A0410N  
 Extra clear transparent glass tumbler for arts. A0410N  
 Verre en verre transparent extra clair pour les arts. A0410N  
 Vaso de vidrio transparente extraclaro para los art. A0410N

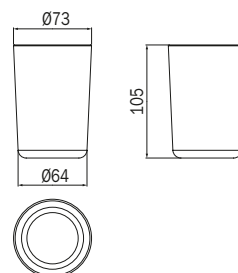

cod.	pz.	€
R03600	1	12,80

**R01100**

Bicchiere in PMMA per artt. A0410N  
 PMMA tumbler for arts. A0410N  
 Verre en PMMA pour les arts. A0410N  
 Vaso en PMMA para los art. A0410N

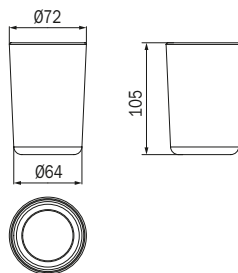

cod.	pz.	€
<b>R01100</b>	1	5,40

**R03110**

Bacinella in vetro extrachiaro trasparente per art. A0410N  
 Extra clear transparent glass dish for art. A0410N  
 Coupelle en verre transparent extra clair pour art. A0410N  
 Cubeta de vidrio transparente extraclaro para art. A0410N

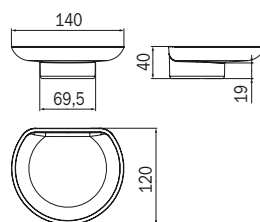

cod.	pz.	€
<b>R03110</b>	1	20,10

**AV425A**

Portarotolo doppio  
 Double paper holder  
 Porte-rouleau double  
 Portarrollos doble

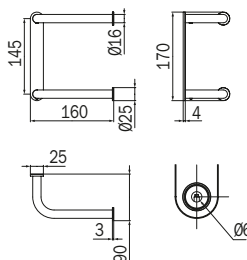

cod.	pz.	€	CR	NE
<b>AV425A ...</b>	1	62,90	72,70	

## HOTELLERIE

## AV425B

Portarotolo doppio con coperchio  
 Double paper holder, with cover  
 Porte-rouleau double avec couvercle  
 Portarrollos doble con tapa

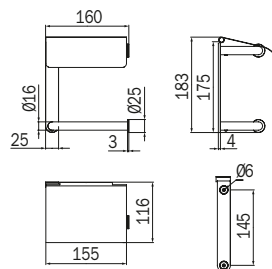

		CR	
cod.	pz.	€	€
AV425B ...	1	93,20	

## A3827A

Portarotolo con coperchio no rumore. 007: confezione da 10 pz.  
 Paper holder with noiseless cover. 007: the packing contains 10 pcs.  
 Porte-rouleau avec couvercle silencieux. 007: lot de 10 pz.  
 Portarrollos con tapa no ruido. 007: paquete de 10 piezas

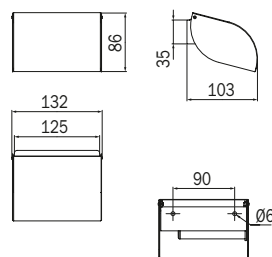

		CR	CR 007
cod.	pz.	€	€
A3827A ...	1	66,20	57,50



## AV426D

Portarotolo doppio  
 Double paper holder  
 Porte-rouleau double  
 Portarrollos doble

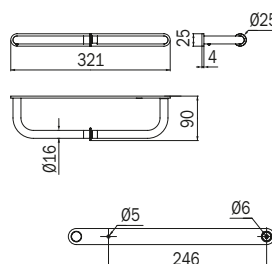

		CR	
cod.	pz.	€	€
AV426D ...	1	70,50	



**AV426E**

Portarotolo doppio con coperchio  
 Double paper holder, with cover  
 Porte-rouleau double avec couvercle  
 Portarrollos doble con tapa

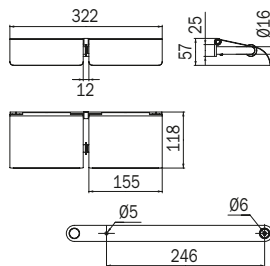

		CR
cod.	pz.	€
AV426E ...	1	111,60

**AV426F**

Portarotolo con coperchio  
 Paper holder with cover  
 Porte-rouleau avec couvercle  
 Portarrollos con tapa

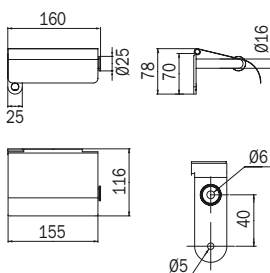

		CR
cod.	pz.	€
AV426F ...	1	68,30

**A8028D**

Portarotolo da incasso con coperchio  
 Built in paper holder with cover  
 Porte-rouleau encastré avec couvercle  
 Portarrollos con tapa encastrada

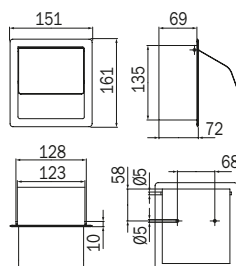

		AL
cod.	pz.	€
A8028D ...	1	82,30

## HOTELLERIE

## A8029D



Portarotolo doppio da incasso con coperchio  
 Built in double paper holder with cover  
 Porte-rouleau double encastré avec couvercle  
 Portarrollos doble con tapa encastrada

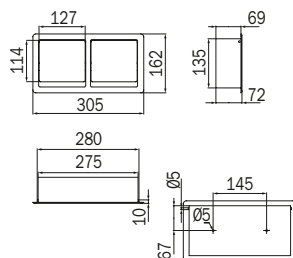

		AL	
cod.	pz.	€	€
A8029D ...	1	139,70	

## A38250

Portarotolo. 007: confezione da 10 pz.  
 Paper holder. 007: the packing contains 10 pcs.  
 Porte-rouleau. 007: lot de 10 pz.  
 Portarrollos. 007: paquete de 10 piezas

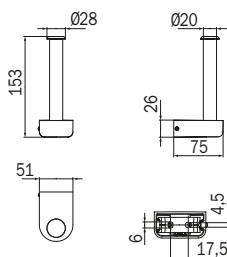

		CR		CR 007
cod.	pz.	€	€	€
A38250 ...	1	58,60	50,50	

## A04270

Portarotolo ad incasso per base portavaso  
 Built-in paper holder, for washbasin base unit  
 Porte-rouleau encastré pour meuble sous-vasque  
 Portarrollos encastrado para base portavaso

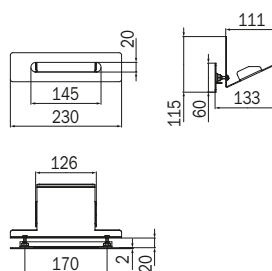
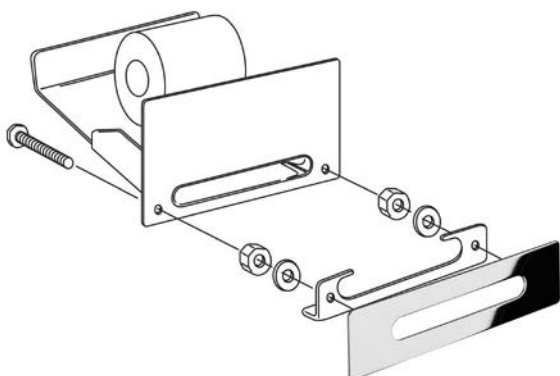

		CR	
cod.	pz.	€	€
A04270 ...	1	67,30	

**AV427G**

Portarotolo a parete, rotolo Ø max 30 cm  
 Wall-mounted paper holder, roll Ø max 30  
 Porte-rouleau mural, rouleau Ø max 30 cm  
 Portarrollos de pared, rollo Ø máx 30 cm

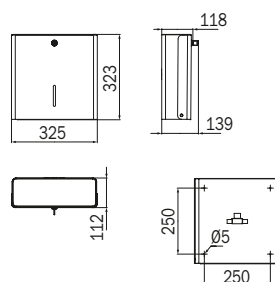

cod.	pz.	AL	NE
AV427G ...	1	125,60	145,20

**AV014A**

Portascopino da parete/da appoggio. 007: confezione da 10 pz.  
 Wall mounted/free-standing toilet brush holder. 007: the packing contains 10 pcs.  
 Porte-balai mural/à poser. 007: lot de 10 pz.  
 Escobillero de pared/de suelo. 007: paquete de 10 piezas

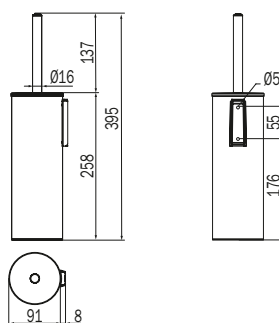

cod.	pz.	CR 007
AV014A ...	1	90,10

**AV014B**

Portascopino da parete/da appoggio. 007: confezione da 10 pz.  
 Wall mounted/free-standing toilet brush holder. 007: the packing contains 10 pcs.  
 Porte-balai mural/à poser. 007: lot de 10 pz.  
 Escobillero de pared/de suelo. 007: paquete de 10 piezas

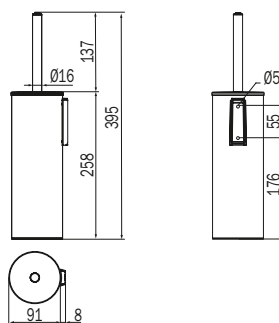

cod.	pz.	CR 007
AV014B ...	1	90,10

## HOTELLERIE

**A3814A**

Portascopino da parete/da appoggio. Scovolo di ricambio bianco incluso 007: confezione da 10 pz.  
 Wall mounted/free-standing toilet brush holder. White spare brush included. 007: the packing contains 10 pcs.  
 Porte-balai mural/à poser. Balayette de rechange blanche incluse. 007: lot de 10 pz.  
 Escobillero de pared/de suelo. Escobilla de repuesto blanca incluida. 007: paquete de 10 piezas

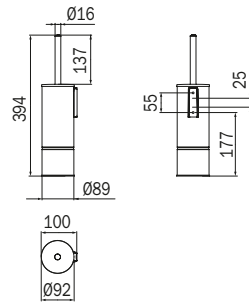

cod.	pz.	€	€
A3814A ...	1	97,50	88,90

**AV414A**

Portascopino da parete/da appoggio  
 Wall mounted/free-standing toilet brush holder  
 Porte-balai mural/à poser  
 Escobillero de pared/de suelo

NEW

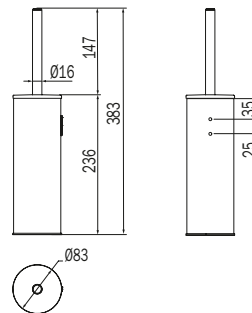

cod.	pz.	€	€
AV414A ...	1	81,40	87,30

**AV414B**

Portascopino da parete/da appoggio  
 Wall mounted/free-standing toilet brush holder  
 Porte-balai mural/à poser  
 Escobillero de pared/de suelo

NEW

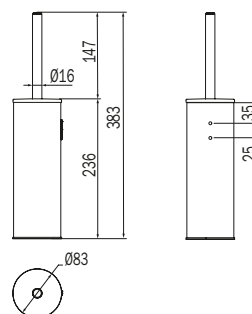

cod.	pz.	€	€
AV414B ...	1	87,30	

**A04140**

Portascopino da parete con bacinella in ABS cromato  
 Wall-mounted toilet brush holder with dish in chrome ABS  
 Porte-balai mural avec pot en ABS chromé  
 Escobillero de pared con cubeta de ABS cromado

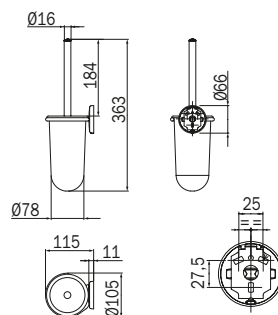

		CR	
cod.	pz.	€	
A04140 ...	1	68,30	

**A05140**

Portascopino da parete con bacinella in polipropilene (PP). 003: confezione da 10 pz.  
 Wall-mounted toilet brush holder with dish in polypropylene (PP). 003: the packing contains 10 pcs.  
 Porte-balai mural avec coupelle en polypropylène (PP). 003: lot de 10 pz.  
 Escobillero de pared con cubeta de polipropileno (PP). 003: paquete de 10 piezas

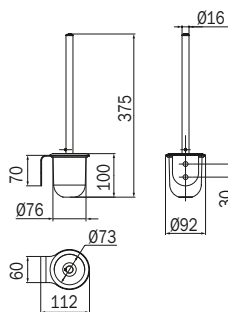

		CR		CR 003	
cod.	pz.	€		€	
A05140 ...	1	56,50		47,60	

**AV8140**

Portascopino da terra con bacinella in polipropilene (PP). 007: confezione da 10 pz.  
 Free-standing toilet brush holder with dish in polypropylene (PP). 007: the packing contains 10 pcs.  
 Porte-balai à poser avec pot en polypropylène (PP). 007: lot de 10 pz.  
 Escobillero de suelo con cubeta de polipropileno (PP). 007: paquete de 10 piezas

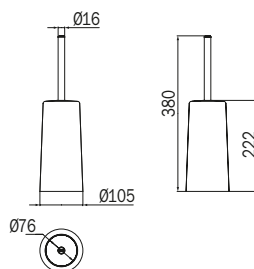

		WZ		WZ 007	
cod.	pz.	€		€	
AV8140 ...	1	43,80		39,50	



## HOTELLERIE

## A07140

Portascopino da terra con bacinella in polipropilene (PP)  
 Free-standing toilet brush holder with basin in polypropylene (PP)  
 Porte-balai à poser avec coupelle en polypropylène (PP)  
 Escobillero de suelo con cubeta de polipropileno (PP)

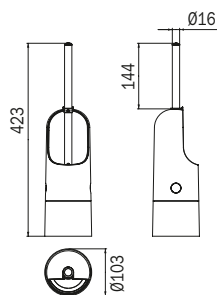

		WW
cod.	pz.	€
A07140 ...	1	38,30

## A04250

Portakleenex ad incasso per base portlavabo  
 Built-in kleenex dispenser, for washbasin base unit  
 Distributeur kleenex à encastrer pour meuble sous-vasque  
 Distribuidor de kleenex encastrado para base portlavabo

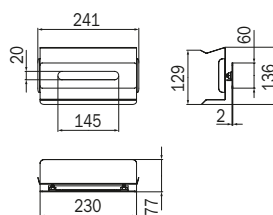
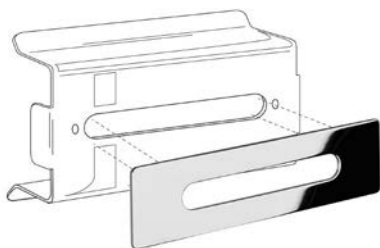

		CR
cod.	pz.	€
A04250 ...	1	77,00

## A0525C

Portakleenex ad incasso. 007: confezione da 10 pz.  
 Built-in kleenex dispenser. 007: the packing contains 10 pcs.  
 Distributeur de mouchoirs en papier à encastrer. 007: lot de 10 pz.  
 Distribuidor de pañuelos de papel encastrado. 007: paquete de 10 piezas

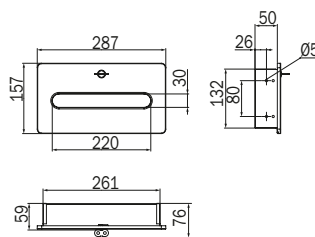

		AL	AL 007
cod.	pz.	€	€
A0525C ...	1	83,50	74,70



**AV0710**

Portakleenex da appoggio in ABS  
 Tabletop kleenex dispenser in ABS  
 Distributeur de mouchoirs en papier à poser en ABS  
 Distribuidor de pañuelos de papel de apoyo de ABS

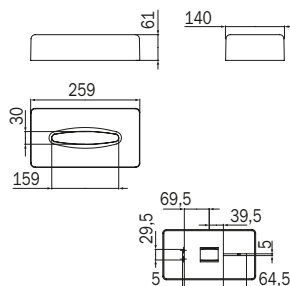

		CR		NE
cod.	pz.	€	€	€
AV0710 ...	1	45,40	52,20	

**AV071Z**

Portakleenex da appoggio in ABS  
 Tabletop kleenex dispenser in ABS  
 Distributeur de mouchoirs en papier à poser en ABS  
 Distribuidor de pañuelos de papel de apoyo de ABS

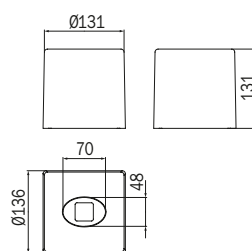

		CR		NE
cod.	pz.	€	€	€
AV071Z ...	1	48,50	56,50	

**A07250**

Portakleenex a parete. 007: confezione da 10 pz.  
 Wall-mounted kleenex dispenser. 007: the packing contains 10 pcs.  
 Distributeur de mouchoirs en papier mural. 007: lot de 10 pz.  
 Distribuidor de pañuelos de papel de pared. 007: paquete de 10 piezas

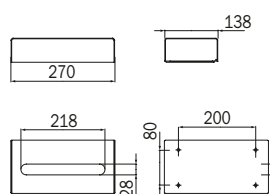

		AL		AL 007
cod.	pz.	€	€	€
A07250 ...	1	77,00	60,70	

## HOTELLERIE

## AV0420

Distributore di sacchetti igienici in acciaio. 007: confezione da 10 pz.  
 Steel sanitary bag dispenser. 007: the packing contains 10 pcs.  
 Distributeur de sachets hygiéniques en acier. 007: lot de 10 pz.  
 Dispensador de bolsas higiénicas de acero. 007: paquete de 10 piezas

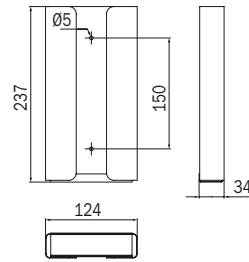

		AL		AL 007
cod.	pz.	€	€	€
AV0420 ...	1	36,30	33,50	

## AV042A

Distributore di sacchetti igienici in ABS  
 ABS sanitary bag dispenser in ABS  
 Distributeur de sachets hygiéniques en ABS  
 Dispensador de bolsas higiénicas de ABS

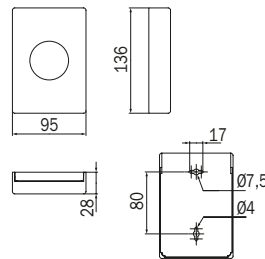

		CR		NE
cod.	pz.	€	€	€
AV042A ...	1	18,00	20,60	

## AV4290

Distributore a parete, per carta a pacchetto - 350 pz.  
 Wall-mounted dispenser, for multifold paper towels - 350 pcs.  
 Distributeur mural, pour serviettes en papier - 350 pz.  
 Distribuidor de toallas de papel a pared - 350 piezas

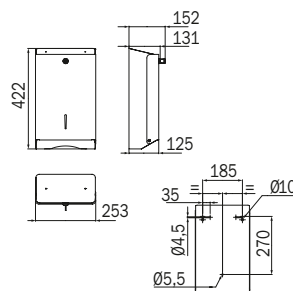

		AL		NE
cod.	pz.	€	€	€
AV4290 ...	1	264,50	305,30	





**A0401C**

Gettacarta con base antiscivolo (AISI 430)  
 Waste basket with anti-slip base (AISI 430)  
 Poubelle, base antidérapante (AISI 430)  
 Papelera, base antideslizante (AISI 430)

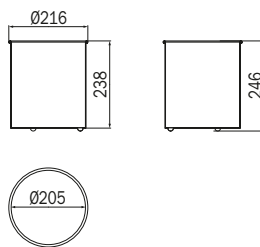

cod.	pz.	€
A0401C ...	1	67,30

**AV4010**

Gettacarta con base antiscivolo (AISI 430)  
 Waste basket with anti-slip base (AISI 430)  
 Poubelle, base antidérapante (AISI 430)  
 Papelera, base antideslizante (AISI 430)

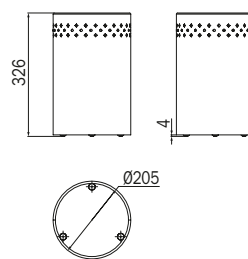

cod.	pz.	€
AV4010 ...	1	73,70

**AV401D**

Gettacarta da parete  
 Wall-mounted waste basket  
 Poubelle murale  
 Papelera de pared

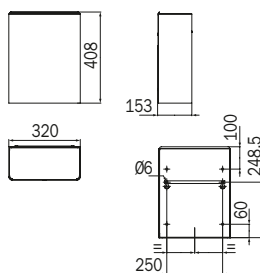

cod.	pz.	€	€
AV401D ...	1	192,70	221,90

## HOTELLERIE

**A13010**

Gettacarta con base antiscivolo (AISI 430)  
 Waste basket with anti-slip base (AISI 430)  
 Poubelle, base antidérapante (AISI 430)  
 Papelera, base antideslizante (AISI 430)

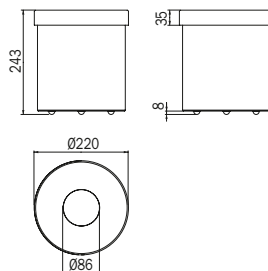

		AL	NE
cod.	pz.	€	€
A13010 ...	1	71,50	82,30

**AV402A**

Gettacarta con coperchio e pedale  
 Dustbin with cover and pedal  
 Poubelle avec couvercle et pédale  
 Cubo para la basura con tapa y pedal

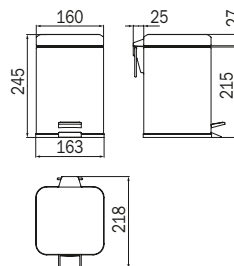

		AL
cod.	pz.	€
AV402A ...	1	44,10

**AV4023**

Gettacarta con coperchio, pedale e base antiscivolo  
 Dustbin with cover and pedal and anti-slip base  
 Poubelle avec couvercle et pédale, base antidérapante  
 Cubo para la basura con tapa y pedal, base antideslizante

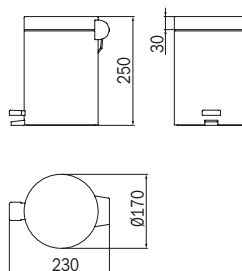

		AL	NE
cod.	pz.	€	€
AV4023 ...	1	53,50	61,80

**AV602A**

Gettacarta con coperchio e pedale (AISI 430)  
 Dustbin with cover and pedal (AISI 430)  
 Poubelle avec couvercle et pédale (AISI 430)  
 Cubo para la basura con tapa y pedal (AISI 430)

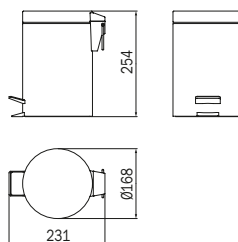

3 Lt.

		AL 001		NS
cod.	pz.	€	€	€
AV602A ...	1	31,40	35,50	

**AV402B**

Gettacarta con coperchio e pedale  
 Dustbin with cover and pedal  
 Poubelle avec couvercle et pédale  
 Cubo para la basura con tapa y pedal

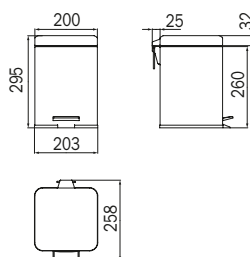

6 Lt.

		AL	
cod.	pz.	€	€
AV402B ...	1	58,60	

**AV4025**

Gettacarta con coperchio, pedale e base antiscivolo  
 Dustbin with cover and pedal and anti-slip base  
 Poubelle avec couvercle et pédale, base antidérapante  
 Cubo para la basura con tapa y pedal, base antideslizante

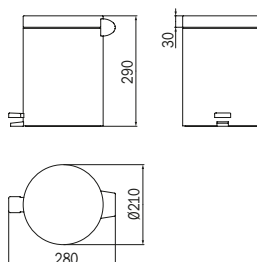

5 Lt.



		AL		NE
cod.	pz.	€	€	€
AV4025 ...	1	71,50	82,30	

## HOTELLERIE

## AV602B

Gettacarta con coperchio e pedale (AISI 430)  
 Dustbin with cover and pedal (AISI 430)  
 Poubelle avec couvercle et pédale (AISI 430)  
 Cubo para la basura con tapa y pedal (AISI 430)

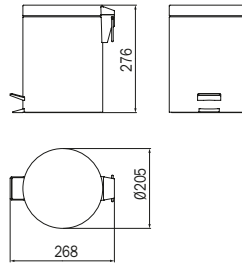

5 Lt.

		AL 001		NS
cod.	pz.	€	€	€
AV602B ...	1	37,30	44,90	

## AV602S

Gettacarta a parete con coperchio  
 Wall-mounted dustbin with cover  
 Poubelle murale avec couvercle  
 Cubo para la basura de pared con tapa

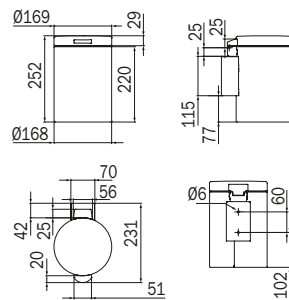

3 Lt.

		AL	
cod.	pz.	€	€
AV602S ...	1	71,50	

## A05300

Portacenere a parete con bacinella in vetro extrachiaro trasparente. 037: Confezione da 10 pz.  
 Wall-mounted ashtray, with extra clear transparent glass dish. 037: The packing contains 10 pcs.  
 Cendrier mural avec coupelle en verre transparent extra clair. 037: Lot de 10 pz.  
 Cendrier mural avec coupelle en verre transparent extra clair. 037: Lot de 10 pz.

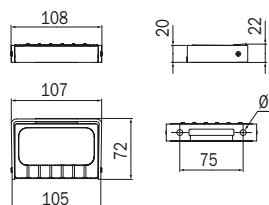

		CR 03		CR 037
cod.	pz.	€	€	€
A05300 ...	1	53,40	49,60	

**A04680**

Portateli  
Bath towel holder  
Rack porte-serviettes  
Toallero/repisa

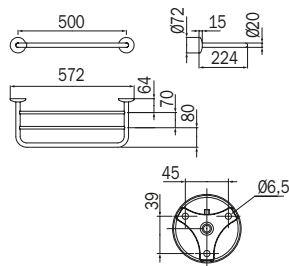

cod.	pz.	€
A04680 ...	1	105,10

**A04690**

Portateli con portasalviette  
Bath towel rack with towel holder  
Rack porte-serviettes  
Repisa con toallero

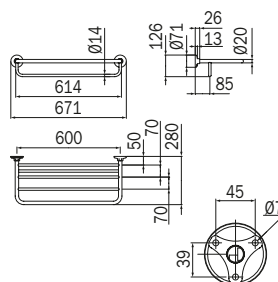
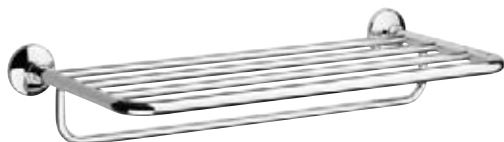

cod.	pz.	€
A04690 ...	1	183,00

**A0470F**

Portateli con portasalviette  
Bath towel rack with towel holder  
Rack porte-serviettes  
Repisa con toallero

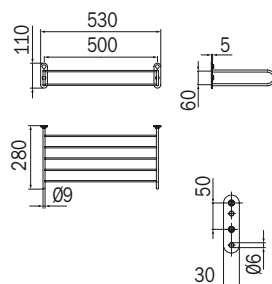

cod.	pz.	€
A0470F ...	1	146,20

## HOTELLERIE

## A13680

Portateli con portasalviette  
Bath towel rack with towel holder  
Rack porte-serviettes  
Repisa con toallero

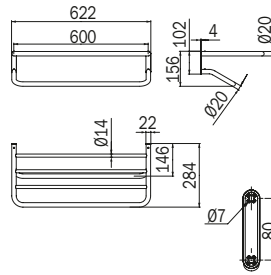

cod.	pz.	€
A13680 ...	1	173,20

CR

## AV408A

Mensola in cristallo temperato 6 mm con supporti  
Tempered crystal shelf, 6 mm glass, with brackets  
Tablette en cristal trempé 6 mm avec supports  
Repisa de cristal templado espesor vidrio 6 mm con soportes

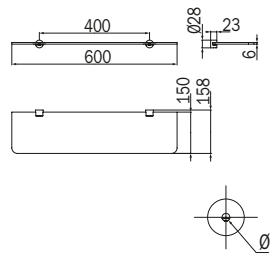

cod.	pz.	€
AV408A ...	1	98,60

CR 01

## AV408C

NEW

Mensola con ringhierina in cristallo temperato 6 mm con supporti  
Tempered crystal shelf with low railing, 6 mm glass  
Tablette avec bord anti-chute en cristal trempé 6 mm avec supports  
Repisa de cristal templado con brandilla, 6 mm con soportes

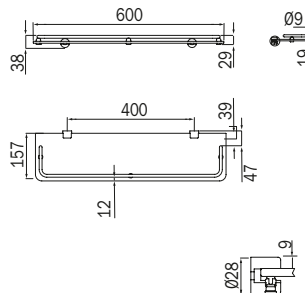

cod.	pz.	€
AV408C ...	1	122,40

CR 01

**RV408A**

Supporti in ottone cromato, confezionati in coppia, da completare con artt. R1150A - R11509, spessore vetro max 6 mm  
 Supports in chrome-plated brass, the packing contains 2 pieces, to be completed with arts R1150A- R11509, max 6 mm thick glass  
 Supports en laiton, vendus par deux, à compléter avec arts. R1150A - R11509, épaisseur verre max 6 mm  
 Soportes de latón, paquetes de 2 unidades, para completar con los art. R1150A - R11509, espesor vidrio máx 6 mm

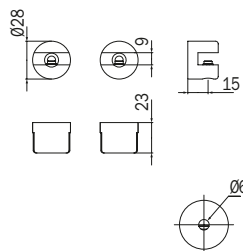

cod.	pz.	€
<b>RV408A</b>	1	36,60

**A1809N**

Supporti in ottone cromato, confezionati in coppia, da completare con artt. R1150A - R11509, spessore vetro max 6 mm  
 Supports in chrome-plated brass, the packing contains 2 pieces, to be completed with arts R1150A- R11509, max 6 mm thick glass  
 Supports en laiton, vendus par deux, à compléter avec arts. R1150A - R11509, épaisseur verre max 6 mm  
 Soportes de latón, paquetes de 2 unidades, para completar con los art. R1150A - R11509, espesor vidrio máx 6 mm

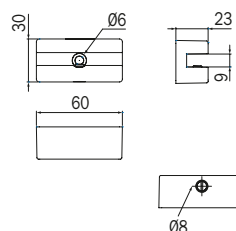

cod.	pz.	€	CR
<b>A1809N ...</b>	1	40,80	

**R11509**

Mensola su misura, ordine minimo 20 pezzi, spessore vetro 6 mm, temperato, per artt. RV408A - R1809N  
 Custom made shelf, minimum order 20 pcs, 6 mm glass, tempered. For arts. RV408A - R1809N  
 Tablette sur mesure, commande minimum 20 pièces, épaisseur verre 6 mm, pour arts. RV408A - R1809N  
 Repisa a medida, pedido mínimo 20 piezas, espesor vidrio 6 mm, para los art. RV408A - R1809N

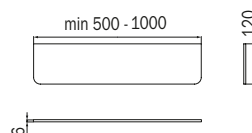

cod.	pz.	€
<b>R11509</b>	1	-

## HOTELLERIE

**R1150A**

Ripiano in cristallo trasparente temperato. Spessore vetro 6 mm  
 Shelf in transparent tempered crystal. 6 mm thick glass  
 Tablette en verre trempé, épaisseur verre 6 mm.  
 Estante de cristal templado, espesor vidrio 6 mm.

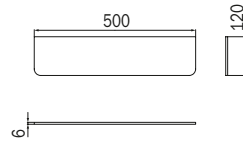

cod.	pz.	€
<b>R1150A</b>	1	43,60

**A04660**

Filo stendibiancheria estensibile. 007: confezione da 10 pz.  
 Extensible clothesline wire. 007: the packing contains 10 pcs.  
 Fil à linge extensible. 007: lot de 10 pz.  
 Tendedero extensible. 007: paquete de 10 piezas

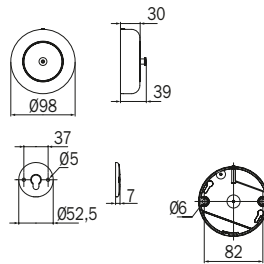

cod.	pz.	€	CR	CR 007
<b>A04660 ...</b>	1	63,90		57,50

**A04030**

Apribottiglia. 007: confezione da 10 pz.  
 Bottle opener. 007: the packing contains 10 pcs.  
 Décapsuleur. 007: lot de 10 pz.  
 Abrebotellas. 007: paquete de 10 piezas

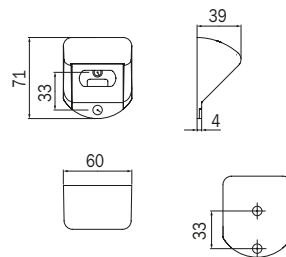

cod.	pz.	€	AL	AL 007
<b>A04030 ...</b>	1	19,70		18,30



**AV454C**

Asciugacapelli con timer e termostato di sicurezza in plastica bianca  
 Hairdryer with timer and safety thermostat in white plastic  
 Sèche-cheveux avec timer et thermostat de sécurité, en plastique blanc  
 Secador de pelo, timer, termostato de seguridad, plástico blanco

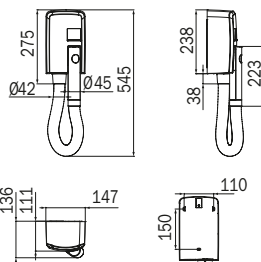

220/240V dB(A): 73  
 1000-1200W MC/H: 54

cod.	pz.	€
AV454C ...	1	200,30

WW

**AV454D**

Asciugacapelli con timer e termostato di sicurezza in plastica bianca  
 Hairdryer with timer and safety thermostat in white plastic  
 Sèche-cheveux avec timer et thermostat de sécurité, en plastique blanc  
 Secador de pelo, timer, termostato de seguridad, plástico blanco

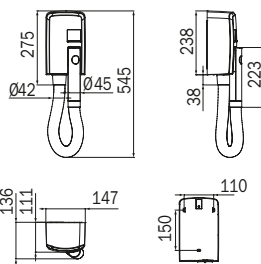

220/240V dB(A): 73  
 1200-1400W MC/H: 54

cod.	pz.	€
AV454D ...	1	241,50

WW

**AV054Y**

Asciugacapelli con termostato di sicurezza e presa elettrica. Funzionamento push. 3 velocità. 1600W  
 Hairdryer with safety thermostat and electrical plug. Push-and-pull mechanism. 3 different speeds. 1600W  
 Sèche-cheveux avec thermostat de sécurité et prise. Commande push. 3 vitesses. 1600W  
 Secador de pelo, termostato de seguridad y toma de corriente. Función Push. 3 velocidades. 1600W

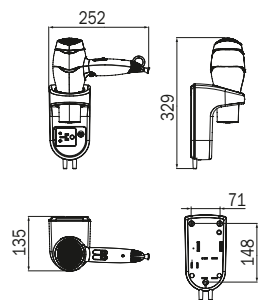

220/240V dB(A): 72  
 220/800/1600W MC/H: 76

cod.	pz.	€
AV054Y ...	1	180,80

SN

## HOTELLERIE

## AV154A

NEW

Asciugacapelli con termostato di sicurezza e presa elettrica. Funzionamento push. 3 velocità. 1800W  
 Hairdryer with safety thermostat and electrical plug. Push-and-pull mechanism. 3 different speeds. 1800W  
 Sèche-cheveux avec thermostat de sécurité et prise. Commande push. 3 vitesses. 1800W  
 Secador de pelo, termostato de seguridad y toma de corriente. Función Push. 3 velocidades. 1800W

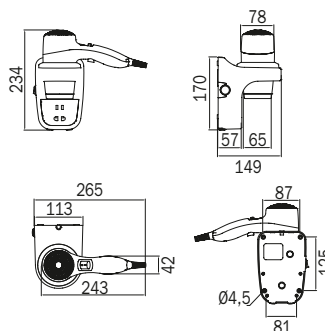
WW  
NW

220/240V dB(A): 62  
 120/1100/1800W MC/H: 83

cod.	pz.	€
AV154A ...	1	146,50

## AV154C

NEW

Asciugacapelli con termostato di sicurezza. Funzionamento push. 2 velocità. 1400W. Convogliatore  
 Hairdryer with safety thermostat. Push-and-pull mechanism. 2 different speeds. 1400W. Nozzle  
 Sèche-cheveux avec thermostat de sécurité et prise. Commande push. 2 vitesses. 1400W. Convoyeur  
 Secador de pelo, termostato de seguridad y toma de corriente. Función Push. 2 velocidades. 1400W. Boquilla

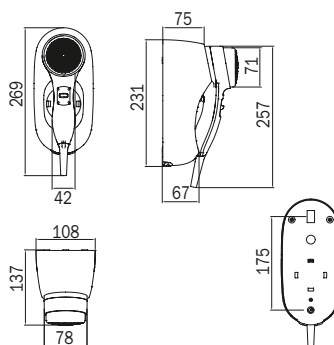

WW



220/240V dB(A): 58  
 140/700/1400W MC/H: 79

cod.	pz.	€
AV154C ...	1	69,70

## A0452D

Asciugacapelli da cassetto con termostato di sicurezza. Funzionamento push. 3 velocità. 1600W  
 Hairdryer for drawer with safety thermostat. Push-and-pull mechanism. 3 different speeds. 1600W  
 Sèche-cheveux avec thermostat de sécurité et prise. Commande push. 3 vitesses. 1600W  
 Secador de pelo de cajón, termostato de seguridad. Función Push. 3 velocidades. 1600W

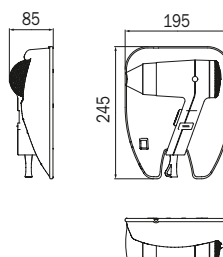

WW



220/240V dB(A): 69  
 220/800/1600W

cod.	pz.	€
A0452D ...	1	138,60

**AV473B****NEW**

Asciugamani elettrico ad alta potenza con termostato di sicurezza. Consumo ridotto. Acciaio Inox AISI304. Collegamento diretto a rete o con presa di corrente  
 High-power electrical hand dryer with safety thermostat. Low consumption. Stainless steel AISI304. Direct connection to the mains or with a socket  
 Sèche-mains électrique puissant avec thermostat de sécurité. Consommation réduite en acier inoxydable AISI 304. Connexion directe au secteur ou avec une prise  
 Secador de manos eléctrico de alta potencia con termostato de seguridad, consumo reducido, Acero Inox AISI304. Conexión directa a la red eléctrica o con un enchufe

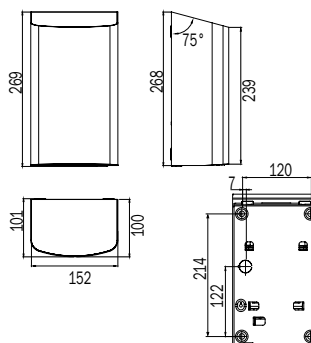

NS



220-240V 50/60Hz dB(A): 69-76  
 1000W m/s: 115

cod.	pz.	€
AV473B ...	1	555,50

**AV474A**

Asciugamani elettrico con termostato di sicurezza  
 Hand dryer with safety thermostat  
 Sèche-mains électrique avec thermostat de sécurité  
 Secador de manos eléctrico con termostato de seguridad

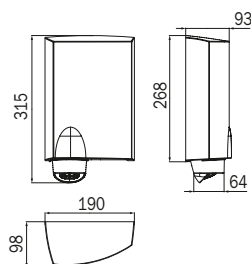

SL



220/240V 1300/1500W dB(A): 78  
 MC/H: 72

cod.	pz.	€
AV474A ...	1	194,80

**A04560**

Fermaporta a pavimento. 007: confezione da 10 pz  
 Floor-mounted doorstop. 007: the packing contains 10 pcs  
 Butée de porte au sol. 007: lot de 10 pz  
 Tope a suelo. 007: paquete de 10 piezas

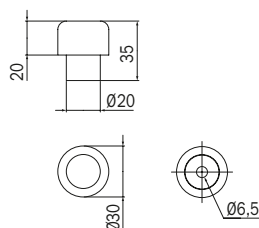

CR 007

cod.	pz.	€
A04560 ...	1	8,50

## HOTELLERIE

**A04570**

Fermaporta a parete. 007: confezione da 10 pz.  
 Wall-mounted doorstop. 007: the packing contains 10 pcs.  
 Butée de porte murale. 007: lot de 10 pz.  
 Tope a pared. 007: paquete de 10 piezas

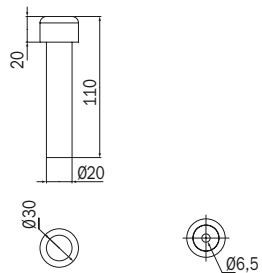

		CR 007
cod.	pz.	€
A04570 ...	1	13,20



## MY MIRROR

**IT** Una nuova serie di specchi ingranditori, sia d'appoggio che da parete, disponibili anche con luce LED integrata. Sono l'accessorio ideale per il make-up e per vedere i dettagli del proprio viso.

**EN** A new serie of magnifying mirrors, both supporting and wall mounted, also available with integrated LED lighting. They are the ideal accessory for makeup and to see the details of your face.

**FR** Une nouvelle série de miroirs grossissants, à la fois d'appui que muraux, également disponibles avec éclairage LED intégré. Ils sont l'accessoire idéal pour le maquillage et pour voir les détails de votre visage.

**ES** Una nueva serie de espejos de aumento, tanto de versión de apoyo como a pared, disponible también con luz LED integrada. Los espejos son el accesorio ideal para el make-up y para poder ver cada detalle de su rostro.



**CR** Cromato  
Chrome-plated  
Chromé  
Cromado

**NE** Nero opaco  
Matt black  
Noir mat  
Negro mate

# MY MIRROR









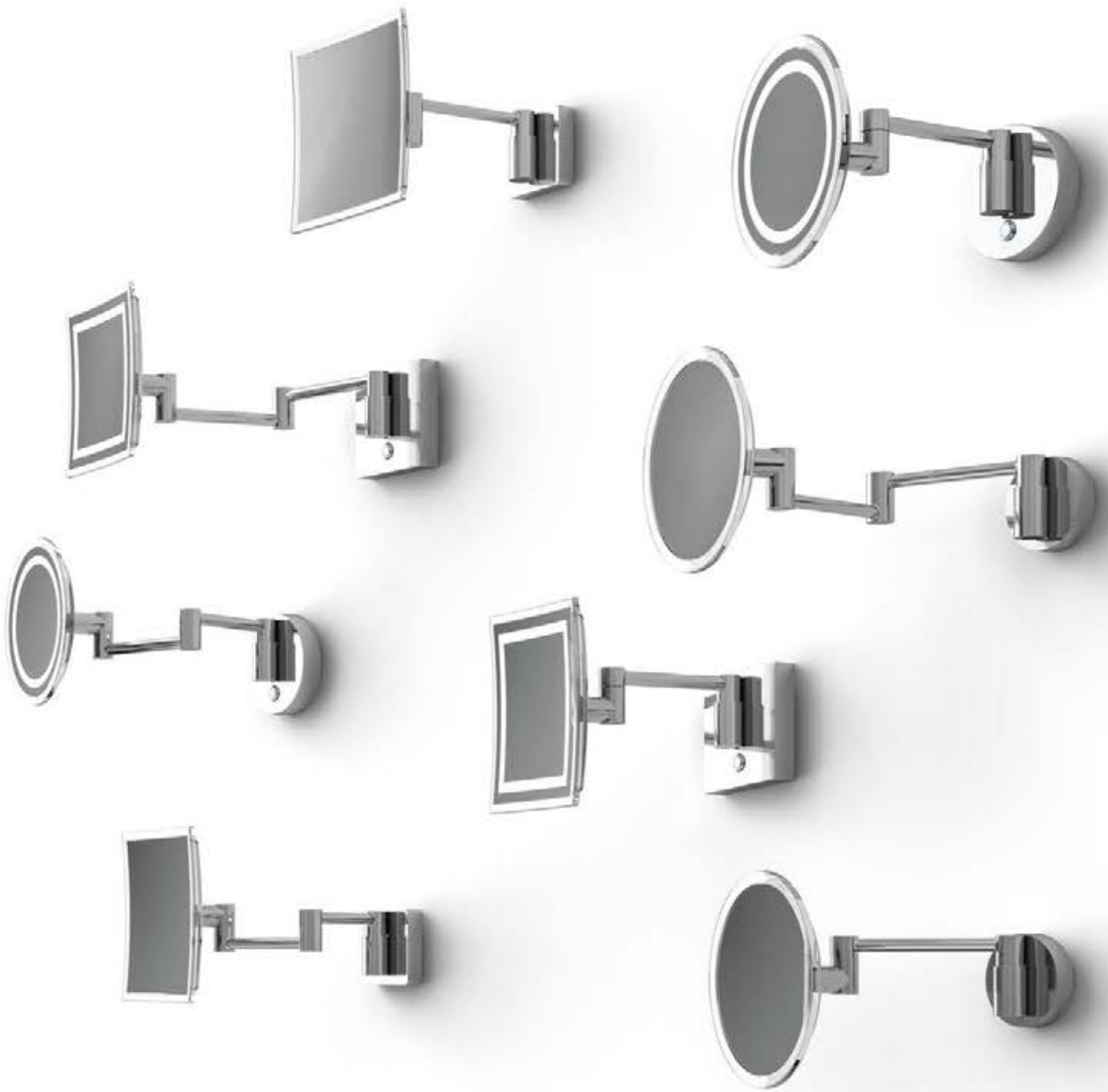

## MY MIRROR

## AV258A

Specchio ingranditore a parete con braccio snodato. Accensione touch. Dimmerabilità colore luce. Collegamento diretto a rete o con presa di corrente  
 Wall-mounted magnifying mirror with articulated arm. Touch switch on. Dimmable light color. Direct connection to the mains or with a socket  
 Miroir grossissant mural avec bras articulé. Touchez pour allumer. Couleur claire dimmable. Connexion directe au secteur ou avec une prise  
 Espejo de aumento de pared con brazo articulado. Encendido touch. Color de luz regulable. Conexión directa a la red eléctrica o con un enchufe

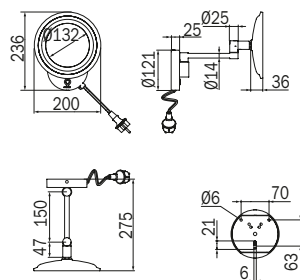

100-240 V  
50-60 Hz 2,5W

cod.	pz.	€	CR	NE
AV258A ...	1	330,10	365,40	

## AV258B

Specchio ingranditore a parete con doppio braccio snodato. Accensione touch. Dimmerabilità colore luce. Collegamento diretto a rete o con presa di corrente  
 Wall magnifying mirror with double jointed arm. Touch switch on. Dimmable light color. Direct connection to the mains or with a socket  
 Miroir grossissant avec bras double articulé. Touchez pour allumer. Couleur claire dimmable. Connexion directe au secteur ou avec une prise  
 Espejo de aumento de pared con doble brazo articulado. Encendido touch. Color de luz regulable. Conexión directa a la red eléctrica o con un enchufe

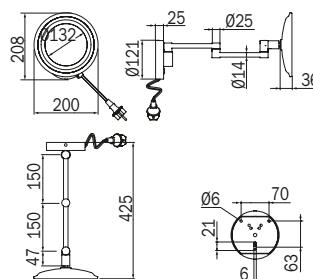

100-240 V  
50-60 Hz 2,5W

cod.	pz.	€	CR
AV258B ...	1	353,50	

## AV258P

Specchio ingranditore da appoggio. Accensione touch. Dimmerabilità colore luce  
 Magnifying mirror with support. Touch switch on. Dimmable light color  
 Miroir grossissant avec support. Touchez pour allumer. Couleur claire dimmable  
 Espejo de aumento de apoyo. Encendido touch. Color de luz regulable

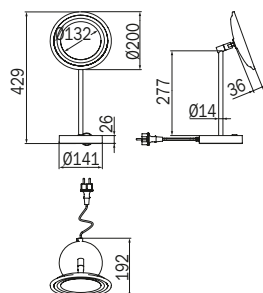

100-240 V  
50-60 Hz 2,5W

cod.	pz.	€	CR
AV258P ...	1	306,50	



## MY MIRROR

## AV158C

Specchio ingranditore a parete con doppio braccio snodato. Collegamento diretto a rete o con presa di corrente  
 Wall magnifying mirror with double jointed arm. Direct connection to the mains or with a socket  
 Miroir grossissant avec bras double articulé. Connexion directe au secteur ou avec une prise  
 Espejo de aumento de pared con doble brazo articulado. Conexión directa a la red eléctrica o con un enchufe

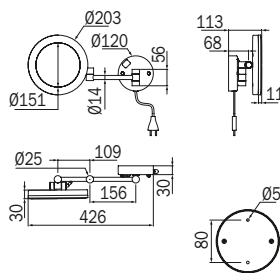

100-240V  
50-60 Hz 6W

cod.	pz.	€
AV158C ...	1	289,30

## AV1580

Specchio ingranditore a parete con braccio snodato. Collegamento diretto a rete. Tasto on/off  
 Wall magnifying mirror with jointed arm. Direct connection to the electricity grid. On/off button  
 Miroir grossissant mural avec bras articulé. Connexion réseau directe. Bouton On/Off  
 Espejo de aumento a pared con brazo giratorio. Conexión directo a red, pulsante on/off

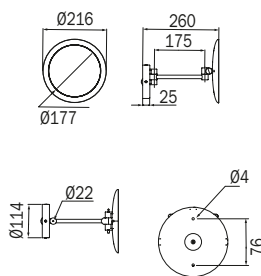

100-240V  
50-60 Hz 4,5W

cod.	pz.	€
AV1580 ...	1	242,00

## AV058X

Specchio ingranditore a parete su asta saliscendi  
 Wall-mounted magnifying mirror on slide rail bar  
 Miroir grossissant mural sur barre "monte et descend"  
 Espejo de aumento de pared, con barra de desplazamiento vertical

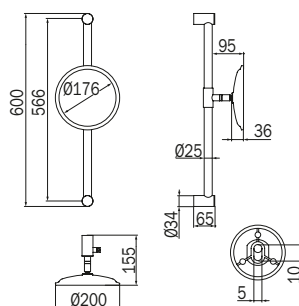

cod.	pz.	€
AV058X ...	1	188,60

**AV058Y**

Specchio ingranditore a parete su asta saliscendi  
 Wall-mounted magnifying mirror on slide rail bar  
 Miroir grossissant mural sur barre "monte et descend"  
 Espejo de aumento de pared, con barra de desplazamiento vertical

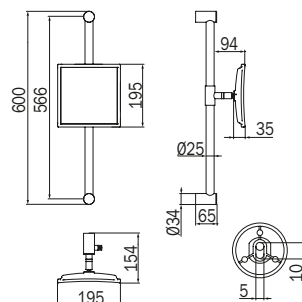

cod.	pz.	€
AV058Y ...	1	200,40

**AV058F**

Specchio ingranditore a parete con braccio snodato  
 Wall-mounted magnifying mirror with articulated arm  
 Miroir grossissant mural avec bras articulé  
 Espejo de aumento de pared con brazo articulado

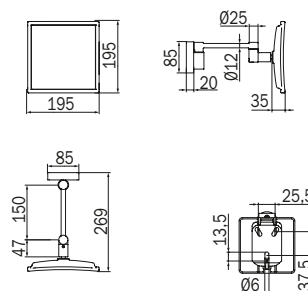

cod.	pz.	€
AV058F ...	1	117,90

**AV058M**

Specchio ingranditore a parete con doppio braccio snodato  
 Wall magnifying mirror with double jointed arm  
 Miroir grossissant avec bras double articulé  
 Espejo de aumento de pared con doble brazo articulado

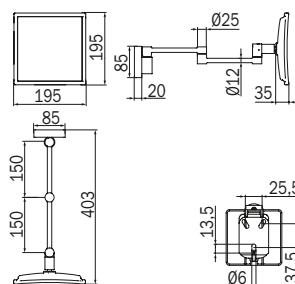

cod.	pz.	€
AV058M ...	1	162,90

## MY MIRROR

## AV058Q

Specchio ingranditore da appoggio  
Magnifying mirror with support  
Miroir grossissant avec support  
Espejo de aumento de apoyo

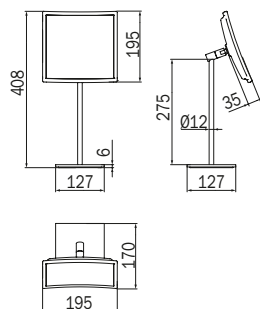

cod.	pz.	€	CR
AV058Q ...	1	172,60	

## AV058C

Specchio ingranditore a parete con doppio braccio snodato. Bifacciale. Pivottante  
Wall magnifying mirror with double jointed arm. Double sided. Pivoting  
Miroir grossissant avec bras double articulé. Double face. Pivotant  
Es-pejo de aumento de pared con doble brazo articulado. De doble cara. Pivotante

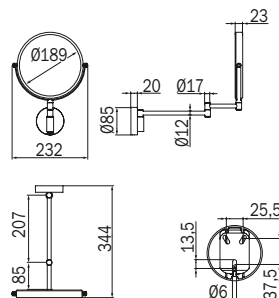

cod.	pz.	€	CR
AV058C ...	1	153,30	

## AV058E

Specchio ingranditore a parete con braccio snodato  
Wall-mounted magnifying mirror with articulated arm  
Miroir grossissant mural avec bras articulé  
Espejo de aumento de pared con brazo articulado

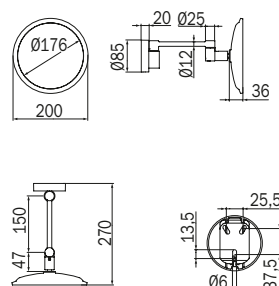

cod.	pz.	€	CR	NE
AV058E ...	1	106,10	141,50	

**AV058L**

Specchio ingranditore a parete con doppio braccio snodato  
 Wall magnifying mirror with double jointed arm  
 Miroir grossissant avec bras double articulé  
 Espejo de aumento de pared con doble brazo articulado

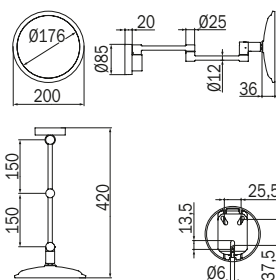

		CR	
cod.	pz.	€	
AV058L ...	1	151,20	

**AV058P**

Specchio ingranditore da appoggio  
 Magnifying mirror with support  
 Miroir grossissant avec support  
 Espejo de aumento de apoyo

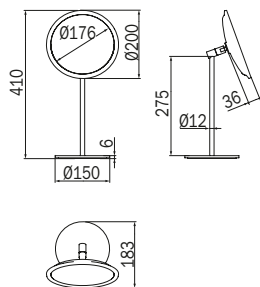

		CR		NE
cod.	pz.	€		€
AV058P ...	1	162,70	176,80	



## COMFORT\_H900

**IT** Comfort è una serie progettata da Matteo Thun per rendere l'ambiente bagno raffinato e piacevole, non solo per le persone con mobilità ridotta, ma anche per tutti gli utenti. Funzionalità, tecnologia ed estetica si fondono per servire coloro che hanno bisogno di aiuto e per i quali la sicurezza ha un valore prioritario anche in bagno. La serie è disponibile in due finiture: cromo e cromato/nero soft touch.

**EN** Comfort is a serie designed by Matteo Thun in order to make the bathrooms environment pleasing and refined, not only for people with reduced mobility, but (also) for all users. Functionality, technology and aesthetics come together to serve those who need help and for whom safety is a priority in the bathroom. The collection is available in two finishes: chrome and chrome plated/black soft touch.

**FR** Comfort conçu par Matteo Thun pour rendre la salle de bains agréable et raffinée, non seulement pour les personnes à mobilité réduite, mais également pour tous les utilisateurs. Fonctionnalité, technologie et esthétique s'unissent pour aider ceux qui ont besoin d'aide et pour ceux pour lesquels la sécurité est une valeur fondamentale dans la salle de bains. La série est disponible en deux finitions : chromé et chromé/noir soft touch.

**ES** Comfort proyectado por Matteo Thun para hacer de los baños un ambiente agradable y refinado, no sólo para las personas con movilidad reducida, sino también para todos los usuarios. Funcionalidad, tecnología y estética se funden para servir a aquellos que tienen necesidad de ayuda y para los cuales la seguridad es un valor prioritario en el baño. Disponible en dos acabados: cromo y cromado/negro soft touch.

	<b>CR</b> Cromato Chrome-plated Chromé Cromado
	<b>CU</b> Cromato/nero soft touch Chrome-plated/black soft touch Chromé/noir soft touch Cromado/negro soft touch

# COMFORT







## COMFORT H900

## AH995

Maniglione di sicurezza  
Safety grip  
Barre d'appui de sécurité  
Manillón de seguridad

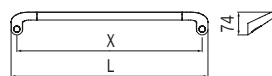

Ø9

CR  
CU

cod.	L	X	pz.	€
AH995A ...	438	400	1	189,50
AH995B ...	638	600	1	204,60



1.500N  
~150Kg

## AH995

Maniglione di sicurezza  
Safety grip  
Barre d'appui de sécurité  
Manillón de seguridad

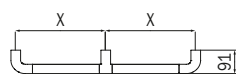
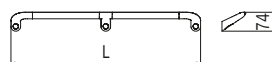

Ø9

CR  
CU

cod.	L	X	pz.	€
AH995C ...	738	350	1	309,60
AH995F ...	1438	700	1	364,80



1.500N  
~150Kg

## AH992A

Maniglione di sicurezza 135°  
Safety grip 135°  
Barre d'appui 135°  
Manillón de seguridad 135°

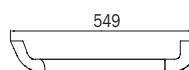
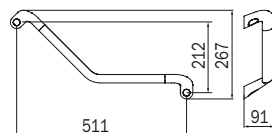

Ø9

CR  
CU

cod.	pz.	€
AH992A ...	1	230,70



1.500N  
~150Kg



**AH996A**

Sostegno di sicurezza verticale destro. Installazione da pavimento a parete  
 Vertical safety support, right hand. Wall-to-floor installation  
 Barre de soutien verticale droite. Installation du mur au sol  
 Soporte de seguridad vertical derecho. Instalación de pared a suelo

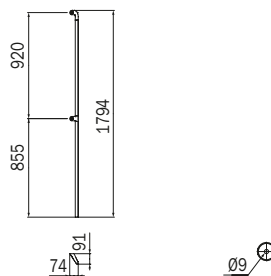
CR  
CU

cod.	pz.	€
AH996A ...	1	334,40

1.500N  
~150Kg**AH996B**

Sostegno di sicurezza verticale sinistro. Installazione da pavimento a parete  
 Vertical safety support, left hand. Wall-to-floor installation  
 Barre de soutien verticale gauche. Installation du mur au sol  
 Soporte de seguridad vertical izquierdo. Instalación de pared a suelo

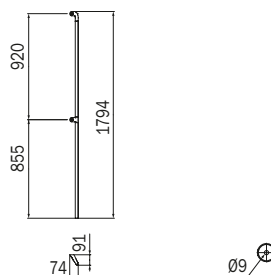
CR  
CU

cod.	pz.	€
AH996B ...	1	334,40

1.500N  
~150Kg**AH993A**

Sostegno di sicurezza destro ad L  
 L shaped safety support, right hand  
 Barre de soutien droite à L  
 Soporte de seguridad derecho en L

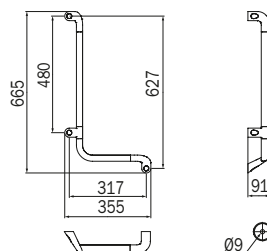
CR  
CU

cod.	pz.	€
AH993A ...	1	338,80

1.500N  
~150Kg

## COMFORT H900

## AH993B

Sostegno di sicurezza sinistro ad L  
L shaped safety support, left hand  
Barre de soutien gauche à L  
Soporte de seguridad izquierdo en L

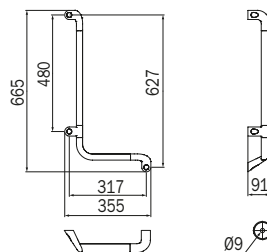
CR  
CU

cod.	pz.	€
AH993B ...	1	338,80

1.500N  
~150Kg

## AH993C

Sostegno di sicurezza destro ad L  
L shaped safety support, right hand  
Barre de soutien droite à L  
Soporte de seguridad derecho en L

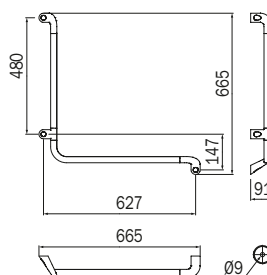
CR  
CU

cod.	pz.	€
AH993C ...	1	362,60

1.500N  
~150Kg

## AH993D

Sostegno di sicurezza sinistro ad L  
L shaped safety support, left hand  
Barre de soutien gauche à L  
Soporte de seguridad izquierdo en L

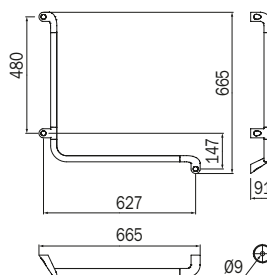
CR  
CU

cod.	pz.	€
AH993D ...	1	362,60

1.500N  
~150Kg

**AH994A**

Sostegno di sicurezza destro ad angolo  
 Corner safety support, right hand  
 Barre de soutien droite d'angle  
 Soporte de seguridad derecho angular

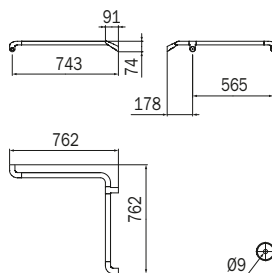

1.500N  
~150Kg

cod.	pz.	€
AH994A ...	1	399,40

CF  
CU

**AH994B**

Sostegno di sicurezza sinistro ad angolo  
 Corner safety support, left hand  
 Barre de soutien gauche d'angle  
 Soporte de seguridad izquierdo angular

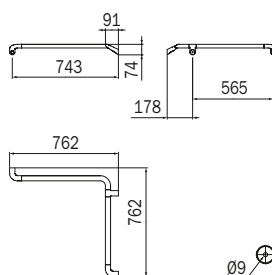

1.500N  
~150Kg

cod.	pz.	€
AH994B ...	1	399,40

CF  
CU

**AH994C**

Sostegno di sicurezza destro ad angolo  
 Corner safety support, right hand  
 Barre de soutien droite d'angle  
 Soporte de seguridad derecho angular

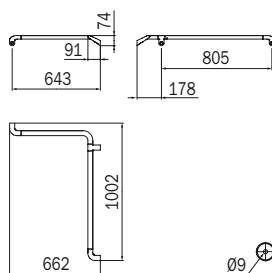

1.500N  
~150Kg

cod.	pz.	€
AH994C ...	1	405,90

CF  
CU

## COMFORT H900

### AH994D

Sostegno di sicurezza sinistro ad angolo  
 Corner safety support, left hand  
 Barre de soutien gauche d'angle  
 Soporte de seguridad izquierdo angular

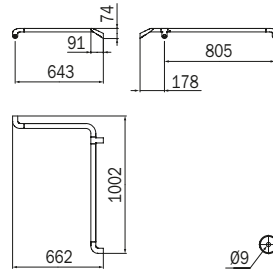

cod.	pz.	€
AH994D ...	1	405,90

CR  
CU

### AH997A

Sostegno di sicurezza fisso zona lavabo/wc  
 Fixed safety support. Washbasin/wc zone  
 Barre de soutien fixe pour zone lavabo/wc  
 Soporte de seguridad fijo zona lavabo/wc

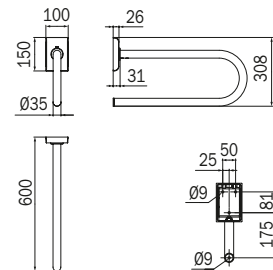

cod.	pz.	€
AH997A ...	1	616,80

CR

### AH997C

Sostegno di sicurezza ribaltabile zona wc  
 Tip-up safety support. Wc zone  
 Barre de soutien relevable pour zone wc  
 Soporte de seguridad abatible zona wc

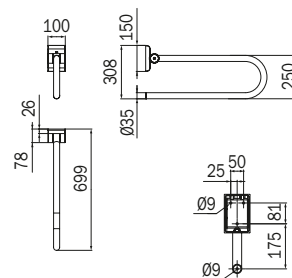

cod.	pz.	€
AH997C ...	1	873,30

CR

**AH925X**

Portarotolo per artt. AH997A - AH997C  
 Paper holder for arts. AH997A - AH997C  
 Porte-rouleau pour les arts. AH997A - AH997C  
 Portarrollos para los art. AH997A - AH997C

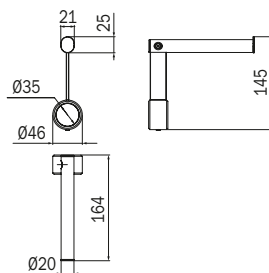

		CR
cod.	pz.	€
AH925X ...	1	110,60

**AH9K1A**

Supporto a muro con placca design per artt. AH997A - AH997C  
 Wall support with design plate for arts. AH997A - AH997C  
 Support mural avec plaque de fixation pour les arts. AH997A - AH997C  
 Soporte de pared, placa design para art. AH997A - AH997C

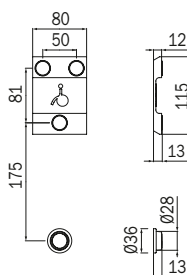

		CR
cod.	pz.	€
AH9K1A ...	1	145,20

# GRAB-BARS



## MANIGLIONI GRAB-BARS BARRES D'APPUI MANILLONES

IT Una serie di maniglioni completa e dalle diverse finiture, realizzata secondo alti standard qualitativi per permettere di muoversi nell'ambiente bagno in totale sicurezza e facilità.

EN A serie of complete handles with different finishes, produced according to high quality standards to allow you to move in the bathroom safely and easily.

FR Une série de poignées complètes avec différentes finitions, réalisées selon des normes de qualité élevées pour vous permettre de vous déplacer dans la salle de bain en toute sécurité et facilité.

ES Una serie completa de manillones con diferentes acabados, fabricados con altos estándares de calidad, que permiten moverse de manera segura y cómoda en el baño.







## MANIGLIONI / GRAB-BARS / BARRES D'APPUI / MANILLONES

### A0490

Maniglione di sicurezza. 007: confezione da 10 pz.  
 Safety grip. 007: the packing contains 10 pcs.  
 Barre d'appui de sécurité. 007: lot de 10 pz.  
 Manillón de seguridad. 007: paquete de 10 piezas

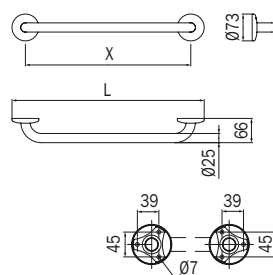

1,100N  
~110Kg

cod.	L	X	pz.	€	CR	CR 007
A0490C ...	673	600	1	72,70		68,30
A0490F ...	523	450	1	62,90		57,50

### A0490T

Maniglione di sicurezza. 007: confezione da 10 pz.  
 Safety grip. 007: the packing contains 10 pcs.  
 Barre d'appui de sécurité. 007: lot de 10 pz.  
 Manillón de seguridad. 007: paquete de 10 piezas

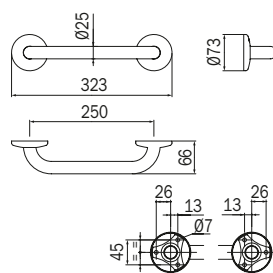

1,500N  
~150Kg

cod.	L	X	pz.	€	CR	CR 007
A0490T ...	323	250	1	48,00		36,90

### A0491T

Maniglione di sicurezza. 007: confezione da 10 pz.  
 Safety grip. 007: the packing contains 10 pcs.  
 Barre d'appui de sécurité. 007: lot de 10 pz.  
 Manillón de seguridad. 007: paquete de 10 piezas

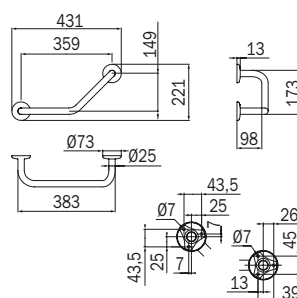

1,500N  
~150Kg



cod.	L	X	pz.	€	CR	CR 007
A0491T ...	431	359	1	68,30		62,90

**A10950**

Maniglione di sicurezza  
Safety grip  
Barre d'appui de sécurité  
Manillón de seguridad

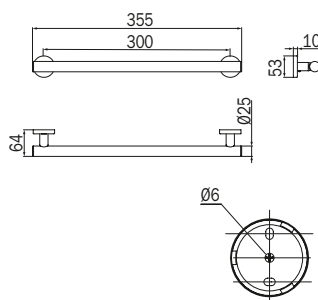

1.500N  
~150Kg

cod.	L	X	pz.	CR	
				€	€
<b>A10950 ...</b>	<b>355</b>	<b>300</b>	<b>1</b>	<b>79,20</b>	<b>87,10</b>

**A1095**

Maniglione di sicurezza  
Safety grip  
Barre d'appui de sécurité  
Manillón de seguridad

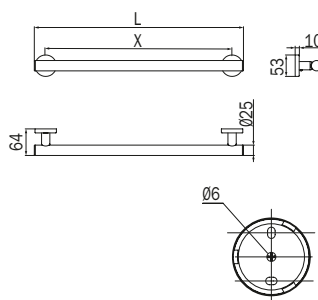

1.500N  
~150Kg

cod.	L	X	pz.	CR	
				€	€
<b>A1095B ...</b>	<b>505</b>	<b>450</b>	<b>1</b>	<b>84,50</b>	
<b>A1095C ...</b>	<b>655</b>	<b>600</b>	<b>1</b>	<b>93,20</b>	

**A1895****NEW**

Maniglione di sicurezza  
Safety grip  
Barre d'appui de sécurité  
Manillón de seguridad

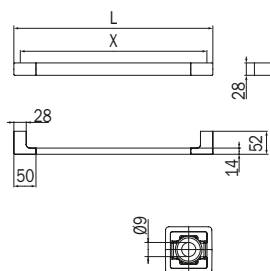

1.500N  
~150Kg

cod.	L	X	pz.	CR					
				€	NE WM	AC	BZ DR	CG OR	€
<b>A1895A ...</b>	<b>300</b>	<b>272</b>	<b>1</b>	<b>96,40</b>	<b>110,90</b>	<b>135,00</b>	<b>154,30</b>	<b>173,60</b>	
<b>A1895B ...</b>	<b>450</b>	<b>422</b>	<b>1</b>	<b>103,00</b>	<b>118,40</b>	<b>144,20</b>	<b>164,80</b>	<b>185,40</b>	
<b>A1895C ...</b>	<b>600</b>	<b>572</b>	<b>1</b>	<b>110,60</b>	<b>127,30</b>	<b>154,90</b>	<b>177,00</b>	<b>199,10</b>	

# MANIGLIONI / GRAB-BARS / BARRES D'APPUI / MANILLONES

## A13950

Maniglione di sicurezza  
Safety grip  
Barre d'appui de sécurité  
Manillón de seguridad

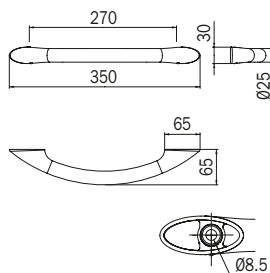

1.500N  
~150Kg

cod.	L	X	pz.	€	CR
A13950 ...	350	270	1	66,20	

## A1390

Maniglione di sicurezza  
Safety grip  
Barre d'appui de sécurité  
Manillón de seguridad

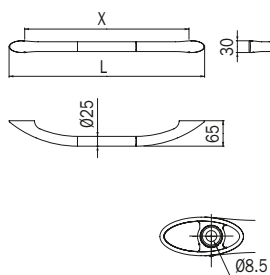

1.200N  
~120Kg

cod.	L	X	pz.	€	CR
A1390B ...	500	420	1	67,90	
A1390C ...	650	570	1	69,40	

## A30950

Maniglione di sicurezza  
Safety grip  
Barre d'appui de sécurité  
Manillón de seguridad

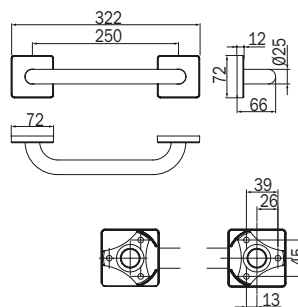

1.500N  
~150Kg

cod.	L	X	pz.	€	CR
A30950 ...	322	250	1	53,60	

**A36950**

Maniglione di sicurezza  
Safety grip  
Barre d'appui de sécurité  
Manillón de seguridad

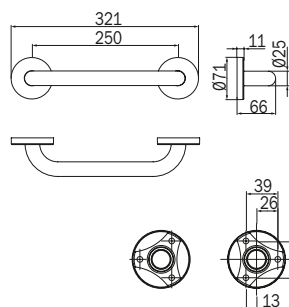

1.500N  
~150Kg

cod.	L	X	pz.	€	CR
A36950 ...	321	250	1	50,50	

**A4690M**

Maniglione di sicurezza  
Safety grip  
Barre d'appui de sécurité  
Manillón de seguridad

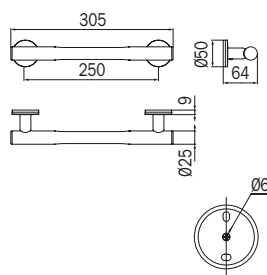

1.200N  
~120Kg

cod.	L	X	pz.	€	CR
A4690M ...	305	250	1	105,10	

**A30920**

Maniglione con cestino  
Grab-bar with basket  
Barre d'appui avec panier  
Manillón con jabónera

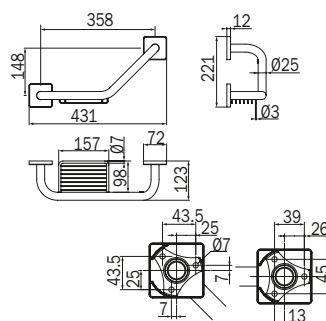
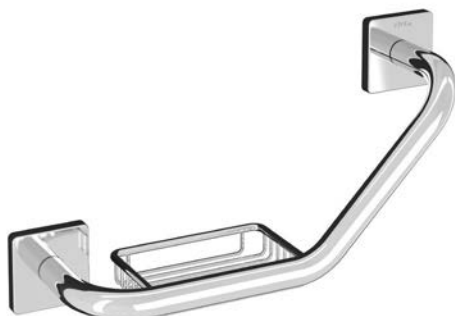

1.500N  
~150Kg



cod.	L	X	pz.	€	CR
A30920 ...	431	358	1	106,10	

# MANIGLIONI / GRAB-BARS / BARRES D'APPUI / MANILLONES

## A36920

Maniglione con cestino  
Grab-bar with basket  
Barre d'appui avec panier  
Manillón con jabonera

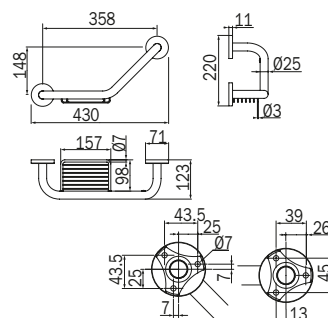

cod.	L	X	pz.	€	CR
A36920 ...	430	358	1	87,80	

## A0492T

Maniglione con cestino  
Grab-bar with basket  
Barre d'appui avec panier  
Manillón con jabonera

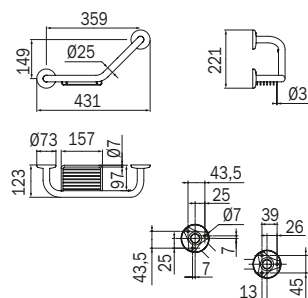

cod.	L	X	pz.	€	CR	CR 007
A0492T ...	431	359	1	110,60	101,80	

## A32920

Maniglione con cestino  
Grab-bar with basket  
Barre d'appui avec panier  
Manillón con jabonera

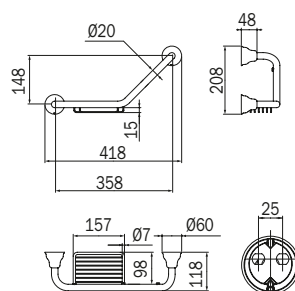

cod.	L	X	pz.	€	CR	BZ	DR
A32920 ...	418	358	1	175,50	251,20	278,10	

**A04620**

Maniglione per doccia, con gomma termoplastica antiscivolo e cestino  
 Grab-bar for shower, with anti-slip thermoplastic rubber and basket  
 Barre d'appui pour douche, avec caoutchouc thermoplastique antidérapant et panier  
 Manillón para ducha, con goma temoplástica antideslizante y jabolnera

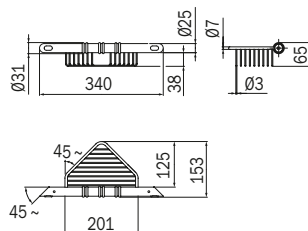

		CR
cod.	pz.	€
A04620 ...	1	110,60

**A0462A**

Maniglione per doccia, con gomma termoplastica antiscivolo e cestino  
 Grab-bar for shower, with anti-slip thermoplastic rubber and basket  
 Barre d'appui pour douche, avec caoutchouc thermoplastique antidérapant et panier  
 Manillón para ducha, con goma temoplástica antideslizante y jabolnera

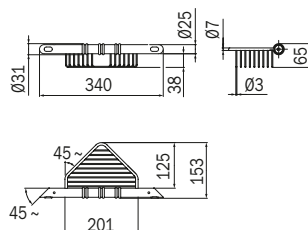
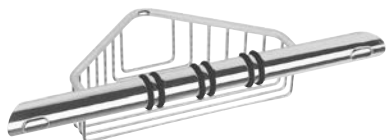

		CR
cod.	pz.	€
A0462A ...	1	110,60

**A04610**

Appoggiapiedi per doccia con gomma termoplastica antiscivolo  
 Foot rest bar for shower with anti-slip thermoplastic rubber  
 Repose-pied pour douche avec caoutchouc thermoplastique antidérapant  
 Barra reposapies para ducha con goma termoplastica antideslizante

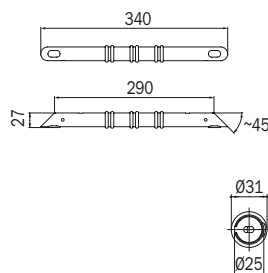

		CR
cod.	pz.	€
A04610 ...	1	45,60

# MANIGLIONI / GRAB-BARS / BARRES D'APPUI / MANILLONES

## A0461A



Appoggiapiedi per doccia con gomma termoplastica antiscivolo  
 Foot rest bar for shower with anti-slip thermoplastic rubber  
 Repose-pied pour douche avec caoutchouc thermoplastique antidérapant  
 Barra reposapies para ducha con goma termoplastica antideslizante

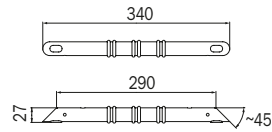

		CR
cod.	pz.	€
A0461A ...	1	45,60





# SGABELLI STOOLS TABOURETS TABURETES

IT Gli sgabelli doccia sono i complementi d'arredo utili e funzionali perfetti per rendere l'ambiente bagno più comodo e sicuro.

EN Shower stools are the useful and functional furnishing accessories perfect for making the bathroom environment more comfortable and safer.

FR Les tabourets de douche sont les accessoires d'ameublement utiles et fonctionnels parfaits pour rendre l'environnement de la salle de bain plus confortable et plus sûr.

ES Los taburetes de ducha son accesorios útiles y funcionales, perfectos para hacer que el ambiente del baño sea más cómodo y seguro.



# STOOLS





## SGABELLI / STOOLS / TABOURETS / TABURETES

### A03750

Sgabello con seduta in resina ureica (UF) e gambe in acciaio  
 Stool with seat in ureic resin (UF), steel legs  
 Tabouret avec assise en résine uréique (UF) et jambes en acier  
 Taburete con asiento de resina ureica (UF), patas de acero

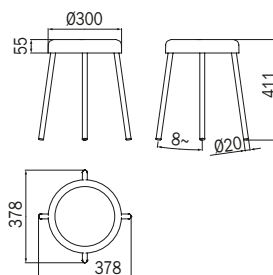

CR

cod.	pz.	€
A03750 ...	1	102,90

### A0436A

Sedile ribaltabile per doccia  
 Folding shower seat  
 Siège relevable pour douche  
 Asiento basculante para ducha

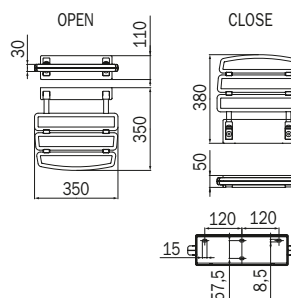

WW

cod.	pz.	€
A0436A ...	1	201,40

1.600N  
-160Kg

### A0438A



Sedile estensibile per vasca  
 Extensible bathtub seat  
 Siège extensible pour baignoire  
 Asiento extensible para bañera

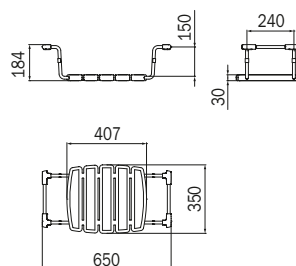

WW

cod.	pz.	€
A0438A ...	1	219,90

1.300N  
-130KG

**AV036B**

Sedile ribaltabile per doccia. Antibatterico  
 Folding shower seat. Antibacterial  
 Siège relevable pour douche. Antibactérien  
 Asiento basculante para ducha. Antibacteriano

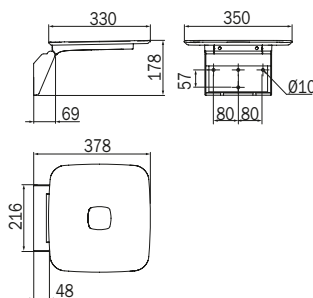

cod.	pz.	€	WZ	NE
AV036B ...	1	238,10	252,30	€

**AV375A**

Sgabello con seduta in ABS e struttura in ottone cromato. Antibatterico  
 Stool with seat, brass structure. Antibacterial  
 Tabouret, assise en ABS, structure en laiton  
 Tabouret, assise en ABS, structure en laiton. Antibactérien

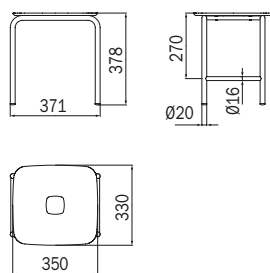

cod.	pz.	€	WW	NE
AV375A ...	1	238,10	252,30	€

**AV375B**

Sgabello con seduta in ABS e struttura in ottone cromato. Antibatterico  
 Stool with seat, brass structure. Antibacterial  
 Tabouret, assise en ABS, structure en laiton. Antibactérien  
 Taburete con asiento de ABS, estructura de latón cromado. Antibacteriano

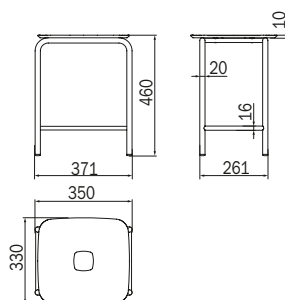

cod.	pz.	€	WW	NE
AV375B ...	1	291,10	304,20	€

# CESTINI BASKETS PANIERS PORTE-SAVON JABONERAS

IT Design e funzionalità si fondono per questa rinnovata serie di cestini per doccia: angolari, removibili, con vaschetta interna o appendibili alla parete doccia, offrono una scelta ampia e variegata.

EN Design and functionality come together for this renewed serie of shower baskets: angular, removable, with internal tray or suspended from the shower wall, they offer a wide and varied choice.

FR Design et fonctionnalité s'unissent pour cette série renouvelée de paniers de douche: angulaires, amovibles, avec bac interne ou suspendus à la paroi de douche, ils offrent un choix large et varié.

ES El diseño y la funcionalidad se unen en esta serie renovada de jaboneras de ducha: angulares, extraíbles, con recipiente interno o para colgar a pared, ofrecen una amplia y variada selección.

# BASKETS





Cestini / Basket  
Panniers porte-savon / Jaboneras







Cestini / Basket  
Panniers porte-savon / Jaboneras



# CESTINI / BASKETS / PANIERS PORTE-SAVON / JABONERAS

## AV251C

Cestino  
Basket  
Panier porte-savon  
Jabonera

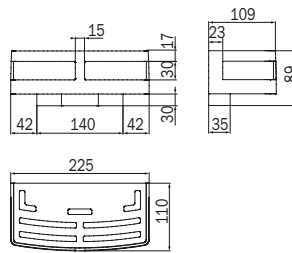

click

cod.	pz.	€	CR	NE
AV251C ...	1	76,70	86,20	

## AV251A

Cestino con bacinella antibatterica estraibile. Bacinella antiscivolo e anti-UV  
Basket with removable antibacterial basin. Anti-slip and anti-UV basin  
Panier avec vasque antibactérien amovible. Vasque anti-dérapant et anti-UV  
Jabonera con cubeta antibacteriano extraíble. Cubeta antideslizante y anti UV

NEW

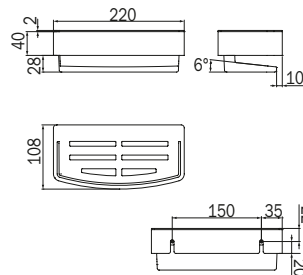

cod.	pz.	€	AL 08 AL 13	NS 08 NS 13	NE 08 WM 13
AV251A ...	1	88,40	96,80	100,00	

08 Nero opaco  
Matt black  
Noir mat  
Negro mate

13 Bianco opaco  
Matt white  
Blanc mat  
Blanco mate

## AV151F

Cestino sganciabile  
Removable basket  
Panier amovible  
Jabonera desmontable

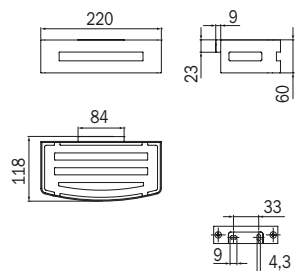

cod.	pz.	€	AL
AV151F ...	1	106,10	

**AV151E**

Cestino sganciabile  
Removable basket  
Panier amovible  
Jabonera desmontable

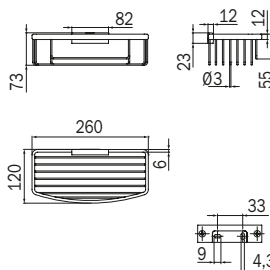

		CR
cod.	pz.	€
AV151E ...	1	87,80

**AV151D**

Cestino sganciabile  
Removable basket  
Panier amovible  
Jabonera desmontable

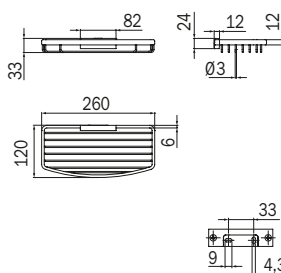

		CR
cod.	pz.	€
AV151D ...	1	81,30

**A1849A**

Cestino  
Basket  
Panier porte-savon  
Jabonera de rejilla

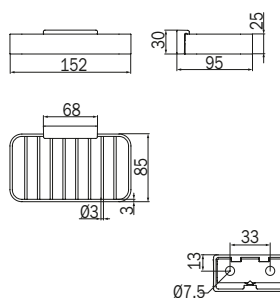

		CR	NE WM	AC	BZ DR	CG OR
cod.	pz.	€	€	€	€	€
A1849A ...	1	59,80	69,70	83,80	96,10	107,70

# CESTINI / BASKETS / PANIERS PORTE-SAVON / JABONERAS

## A1851A

Cestino  
Basket  
Panier porte-savon  
Jabonera de rejilla

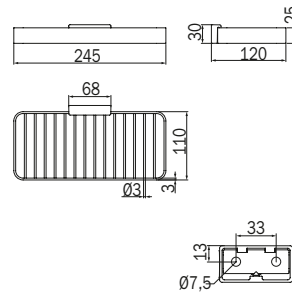

		CR	NE WM	AC	BZ DR	CG OR
cod.	pz.	€	€	€	€	€
A1851A ...	1	84,10	97,30	117,90	134,90	151,50

## A18510

Cestino  
Basket  
Panier porte-savon  
Jabonera de rejilla

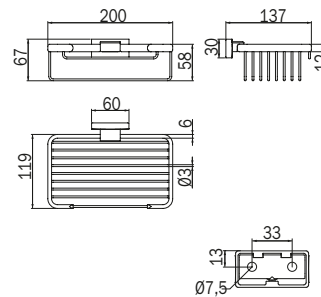
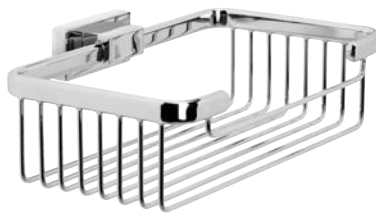

		CR	NE WM	AC	BZ DR	CG OR
cod.	pz.	€	€	€	€	€
A18510 ...	1	69,70	80,80	97,60	111,70	125,50

## A46510

Cestino  
Basket  
Panier  
Jabonera de rejilla

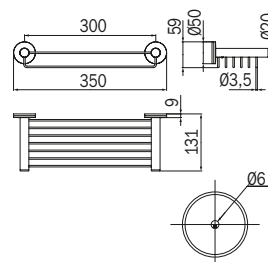
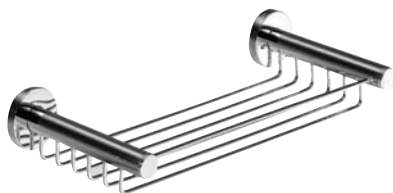

		CR
cod.	pz.	€
A46510 ...	1	164,60

**A32500**

Cestino  
Basket  
Panier porte-savon  
Jabonera de rejilla

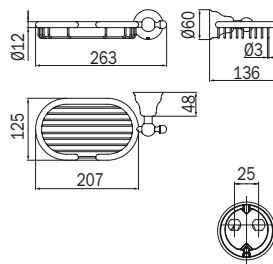

cod.	pz.			
		CR	BZ	DR
		€	€	€
<b>A32500 ...</b>	1	125,60	205,60	229,50

**A1351A**

Cestino  
Basket  
Panier porte-savon  
Jabonera de rejilla

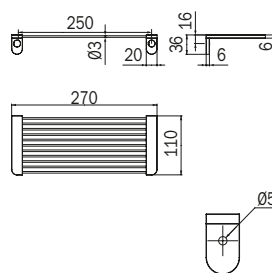

cod.	pz.		
		CR	€
<b>A1351A ...</b>	1	62,90	

**A1051B**

Cestino  
Basket  
Panier porte-savon  
Jabonera

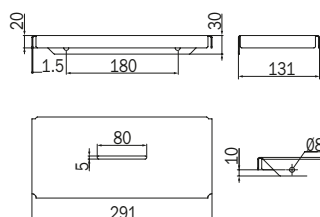

cod.	pz.			
		CR	NS	NE
		€	€	€
<b>A1051B ...</b>	1	81,30	89,50	94,30



## CESTINI / BASKETS / PANIERS PORTE-SAVON / JABONERAS

### A0451H

Cestino. 007: confezione da 10 pz.  
Basket. 007: the packing contains 10 pcs.  
Panier porte-savon. 007: lot de 10 pz.  
Jabonera de rejilla. 007: paquete de 10 piezas

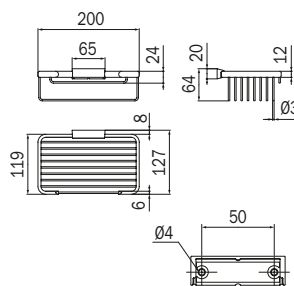

		CR		CR 007
cod.	pz.	€	€	€
A0451H ...	1	66,20	45,50	

### A04500

Cestino. 007: confezione da 10 pz.  
Basket. 007: the packing contains 10 pcs.  
Panier porte-savon. 007: lot de 10 pz.  
Jabonera de rejilla. 007: paquete de 10 piezas

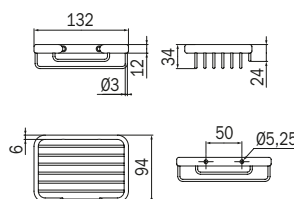
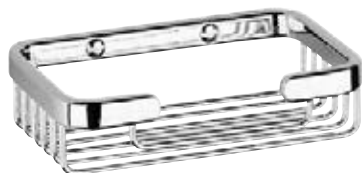

		CR		CR 007
cod.	pz.	€	€	€
A04500 ...	1	39,00	29,30	

### A04510

Cestino. 007: confezione da 10 pz.  
Basket. 007: the packing contains 10 pcs.  
Panier porte-savon. 007: lot de 10 pz.  
Jabonera de rejilla. 007: paquete de 10 piezas

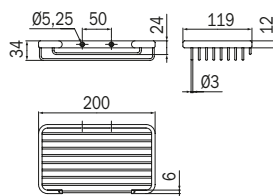
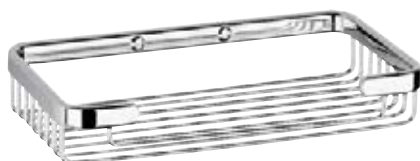

		CR		CR 007
cod.	pz.	€	€	€
A04510 ...	1	52,80	49,60	

**A0453H**

Cestino  
Basket  
Panier  
Jabonera de rejilla

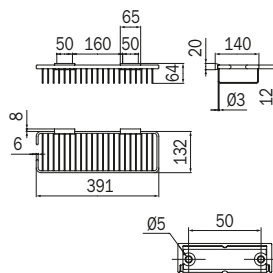

		CR	
cod.	pz.	€	
A0453H ...	1	99,80	

**AV0330**

Cestino doppio appendibile  
Double basket, for hanging  
Panier double, crochetable  
Jabonera de rejilla doble, para colgar

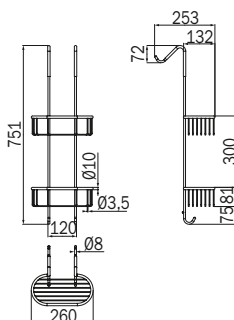

		CR	
cod.	pz.	€	
AV0330 ...	1	215,40	

**AV231C**

Angolare  
Corner  
Porte-objets d'angle  
Jabonera angular

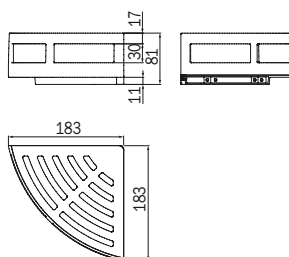

		CR	NE
cod.	pz.	€	€
AV231C ...	1	70,80	79,10

# CESTINI / BASKETS / PANIERS PORTE-SAVON / JABONERAS

## AV231A

NEW

Angolare con bacinella antibatterica estraibile. Bacinella antiscivolo e anti-UV  
 Angular with removable antibacterial cup. Anti-slip and anti-UV cup  
 Angulaire avec coupelle antibactérien amovible. Coupelle anti-dérapant et anti-UV  
 Angular con cubeta extraíble (antibacterial). Cubeta antideslizamiento y Anti-UV

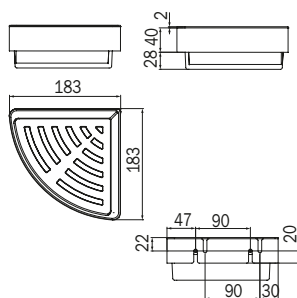

cod.	pz.	AL 08 AL 13		NS 08 NS 13		NE 08 WM 13	
		€	€	€	€		
AV231A ...	1	82,60	90,80	95,00			

08 Nero opaco  
 Matt black  
 Noir mat  
 Negro mate

13 Bianco opaco  
 Matt white  
 Blanc mat  
 Blanco mate



## AV131F

Angolare sganciabile  
 Removable corner  
 Porte-objets d'angle amovible  
 Jabonera angular desmontable

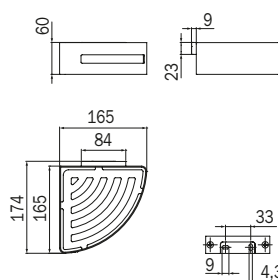

cod.	pz.	AL	
		€	€
AV131F ...	1	87,80	



## AV131E

Angolare sganciabile  
 Removable corner  
 Porte-objets d'angle amovible  
 Jabonera angular desmontable

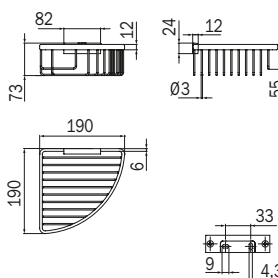

cod.	pz.	CR	
		€	€
AV131E ...	1	85,50	





**AV131D**

Angolare sganciabile  
Removable corner  
Porte-objets d'angle amovible  
Jabonera angular desmontable

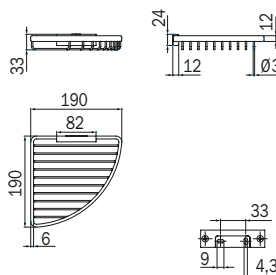

		CR
cod.	pz.	€
AV131D ...	1	78,10

**A18310**

Angolare  
Corner  
Porte-objets d'angle  
Jabonera angular

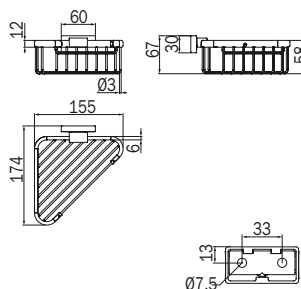

		CR	NE WM	AC	BZ DR	CG OR
cod.	pz.	€	€	€	€	€
A18310 ...	1	60,90	70,80	85,40	97,30	109,70

**A1331A**

Angolare  
Corner  
Porte-objets d'angle  
Jabonera angular

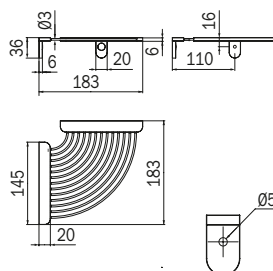

		CR
cod.	pz.	€
A1331A ...	1	56,50

# CESTINI / BASKETS / PANIERS PORTE-SAVON / JABONERAS

## A1031B

Angolare  
Corner  
Porte-objets d'angle  
Jabonera angular

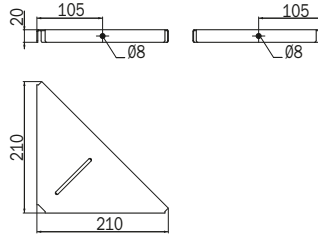

cod.	pz.			
		CR	NS	NE
A1031B ...	1	68,30	75,20	79,20

## AV031A

Angolare  
Corner  
Porte-objets d'angle  
Jabonera angular

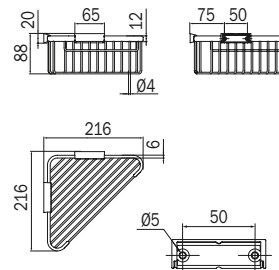

cod.	pz.		
		CR	€
AV031A ...	1	80,20	

## A0449H

Angolare. 007: confezione da 10 pz.  
Corner. 007: the packing contains 10 pcs.  
Porte-objets d'angle. 007: lot de 10 pz.  
Jabonera angular. 007: paquete de 10 piezas

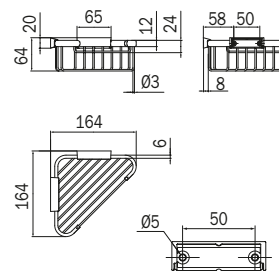

cod.	pz.		
		CR	CR 007
A0449H ...	1	51,10	40,00

**A04490**

Angolare. 007: confezione da 10 pz.  
 Corner. 007: the packing contains 10 pcs.  
 Porte-objets d'angle. 007: lot de 10 pz.  
 Jabonera angular. 007: paquete de 10 piezas

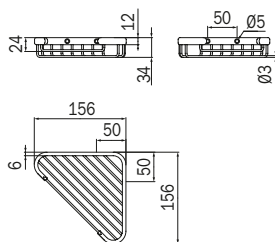

		CR	
cod.	pz.	€	€
A04490 ...	1	45,50	34,00

**AV0310**

Angolare  
 Corner  
 Porte-objets d'angle  
 Jabonera angular

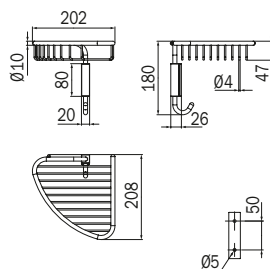

		CR	
cod.	pz.	€	€
AV0310 ...	1	133,20	

**AV032A**

Angolare doppio  
 Double corner  
 Porte-objet d'angle  
 Jabonera angular doble

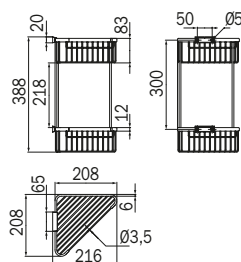

		CR	
cod.	pz.	€	€
AV032A ...	1	172,20	

# CESTINI / BASKETS / PANIERS PORTE-SAVON / JABONERAS

## AV0320

Angolare doppio  
Double corner  
Porte-objets d'angle double  
Jabonera angular doble

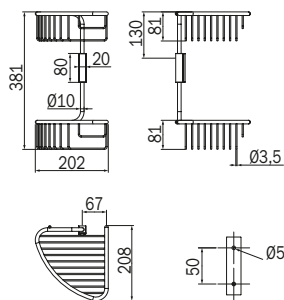
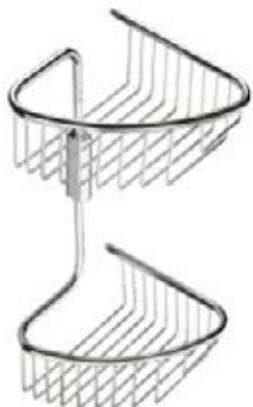

		CR
cod.	pz.	€
AV0320 ...	1	205,60

## A04320

Angolare con 2 ripiani in PMMA  
Double corner shelf in PMMA  
Porte-objet d'angle avec 2 étagères en PMMA  
Jabonera angular con 2 estantes de PMMA

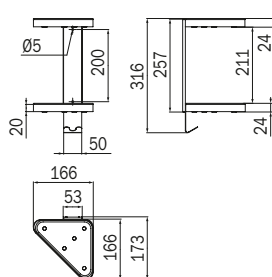

		AL 02
cod.	pz.	€
A04320 ...	1	91,00

## AV033A

Angolare doppio appendibile a destra  
Double corner, right mounting  
Porte-objets d'angle double, crochetable à droite  
Jabonera angular doble, para colgar a la derecha

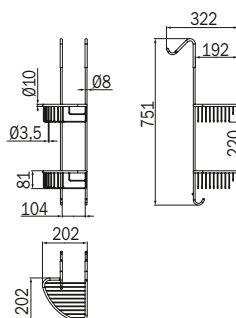

		CR
cod.	pz.	€
AV033A ...	1	213,30

**AV033B**

Angolare doppio appendibile a sinistra  
 Double corner, left mounting  
 Porte-objets d'angle double, crochetable à gauche  
 Jabonera angular doble, para colgar a la izquierda

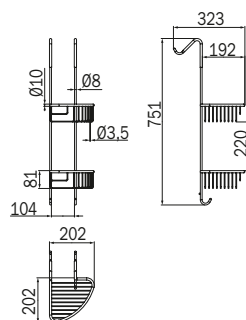

		CR
cod.	pz.	€
AV033B ...	1	213,30



# STANDS

## PIANTANE STANDS ACCESSOIRE SUR PIEDS TOALLEROS DE PIE

IT Nel valore della semplicità, le piantane nascono da una interpretazione del classico fra eleganza nelle forme e essenzialità nei materiali. Accessori dove funzionalità ed estetica si fondono in un raro equilibrio esaltato dalla cura per il dettaglio.

EN In the simplicity value, the stands born from an interpretation of classic between elegance in the forms and the essentiality of materials. Accessories where functionality and aesthetics are blended together in a rare equilibrium, enhanced by the care for details.

FR Dans la valeur de la simplicité, les porte-serviettes sur pieds néent d'une interprétation du classique entre élégance dans les formes et la simplicité des matériaux. Accessoires où la fonctionnalité et l'esthétisme se fondent en un rare équilibre exalté par le soin du détail.

ES En el valor de la simplicidad, nacen de una interpretación de lo clásico entre elegancia en las formas y esencialidad en los materiales. Accesorios donde la funcionalidad y la estética se funden en un logrado equilibrio que ve aprecia en el cuidado del detalle.



Piantane / Stands  
Accessoire sur pieds / Toalleros de pie

## PIANTANE / STANDS / ACCESSOIRE SUR PIEDS / TOALLEROS DE PIE

**A33850**

NEW

Piantana con 2 portasalviette  
 Stand with 2 towel holders  
 Porte-serviettes sur pied avec 2 porte-serviettes  
 Toallero de pie con 2 brazos

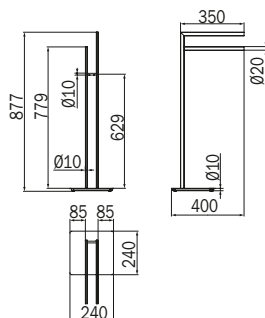

cod.	pz.	€	CR	NE
A33850 ...	1	492,40	539,40	

**AV085C**

Piantana con 2 portasalviette  
 Stand with 2 towel holders  
 Porte-serviettes sur pied avec 2 porte-serviettes  
 Toallero de pie con 2 brazos

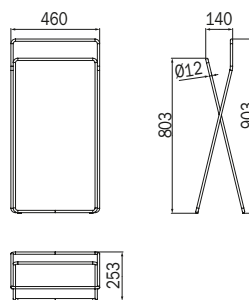
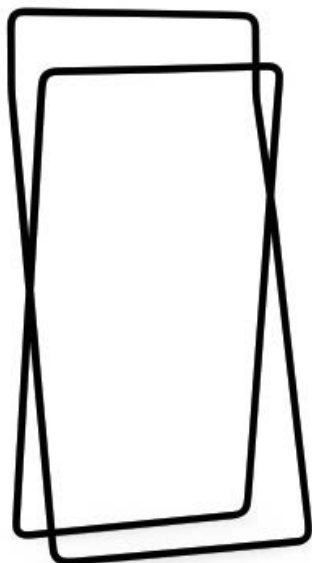

cod.	pz.	€	WM	NE
AV085C ...	1	173,90		



**A05840**

Piantana con 3 portasalviette  
 Stand with 3 towel holders  
 Porte-serviettes sur pied avec 3 porte-serviettes  
 Toallero de pie con 3 brazos

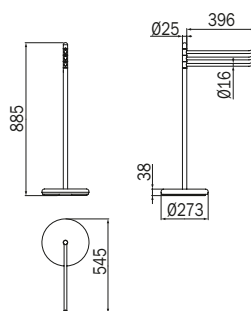

		CR
cod.	pz.	€
A05840 ...	1	262,00

**A05850**

Piantana con 4 portasalviette  
 Stand with 4 towel holders  
 Porte-serviettes sur pied avec 4 porte-serviettes  
 Toallero de pie con 4 brazos

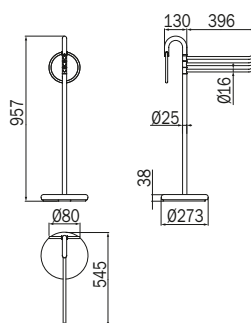
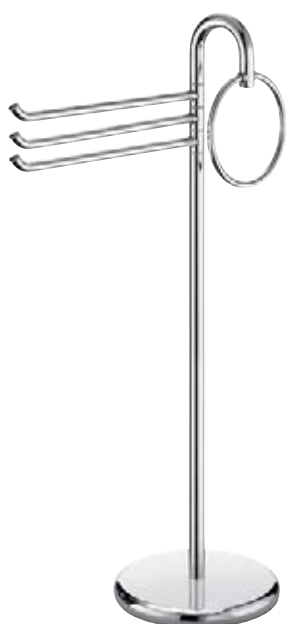

		CR
cod.	pz.	€
A05850 ...	1	285,80

## PIANTANE / STANDS / ACCESSOIRE SUR PIEDS / TOALLEROS DE PIE

**AV085D**

Piantana con 3 portasalviette  
 Stand with 3 towel holders  
 Porte-serviettes sur pied avec 3 porte-serviettes  
 Toallero de pie con 3 brazos

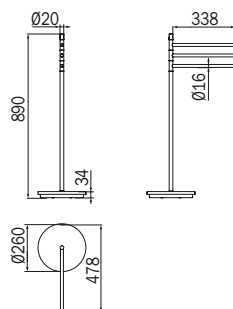

		CR
cod.	pz.	€
AV085D ...	1	211,10

**AV085F**

Piantana con 3 portasalviette  
 Stand with 3 towel holders  
 Porte-serviettes sur pied avec 3 porte-serviettes  
 Toallero de pie con 3 brazos

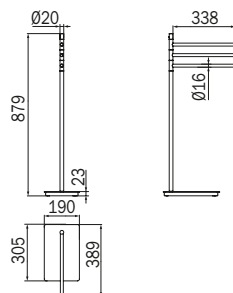

		CR
cod.	pz.	€
AV085F ...	1	260,90

**AV086D**

Piantana con portarotolo e portascopino  
 Stand with paper and toilet brush holder  
 Accessoire sur pied avec porte-rouleau et porte-balai  
 Toallero de pie con portarrollos y escobillero

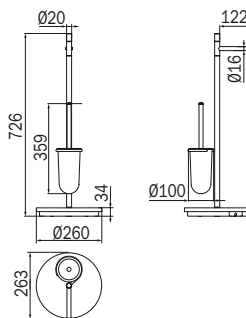

		CR
cod.	pz.	€
AV086D ...	1	233,90

**AV086E**

Piantana con portarotolo e portascopino  
 Stand with paper and toilet brush holder  
 Accessoire sur pied avec porte-rouleau et porte-balai  
 Toallero de pie con portarrollos y escobillero

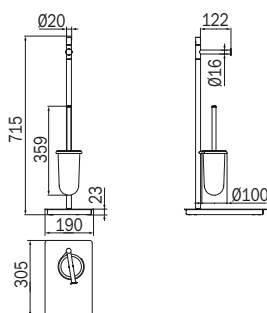

		CR
cod.	pz.	€
AV086E ...	1	272,80

## PIANTANE / STANDS / ACCESSOIRE SUR PIEDS / TOALLEROS DE PIE

**A32850**

Piantana con 3 portasalviette  
 Stand with 3 towel holders  
 Porte-serviettes sur pied avec 3 porte-serviettes  
 Toallero de pie con 3 brazos

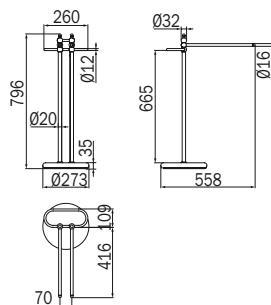
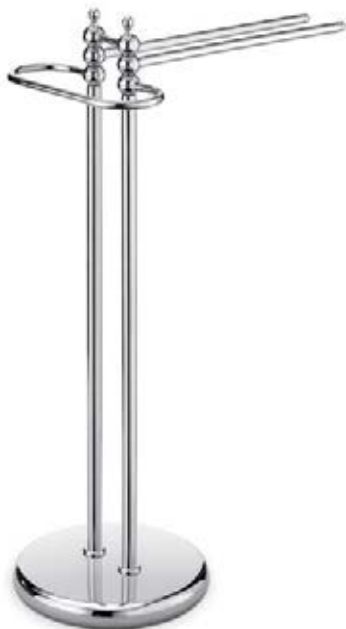

cod.	pz.			
		CR	BZ	DR
A32850 ...	1	377,60	656,90	729,40

**A23240**

Piantana con portarotolo e portascopino  
 Stand with paper and toilet brush holder  
 Accessoire sur pied avec porte-rouleau et porte-balai  
 Toallero de pie con portarrollos y escobillero

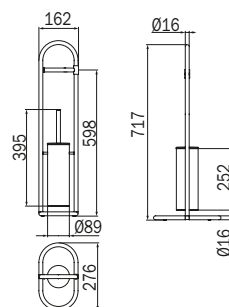

cod.	pz.	
		CR
A23240 ...	1	241,50





# COMPLÉMENTS

## COMPLEMENTI DOCCIA COMPLÉMENTS COMPLÉMENTS COMPLEMENTOS

IT I complementi necessari per completare l'ambiente doccia con tappeti e tende ignifughe.

EN Accessories needed to complete the shower environment with fireproof rugs and curtains.

FR Les accessoires nécessaires pour compléter l'environnement de la douche avec des tapis et rideaux ignifuges.

ES Los accesorios necesarios para complementar el ambiente de ducha con alfombras y cortinas no inflamables.





# COMPLEMENTI DOCCIA / COMPLEMENTS / COMPLÉMENTS / COMPLEMENTOS

## A0146

Tubo per doccia in ottone, tubo Ø 2 cm, estensibile  
 Brass shower rod, Ø 2 cm, extensible  
 Tringle de douche en laiton, tube Ø 2 cm, extensible  
 Tubo para ducha de latón, tubo Ø 2 cm, extensible

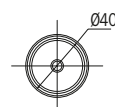
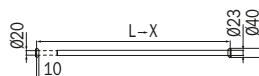

				CR
cod.	L	X	pz.	€
A0146A ...	600	900	1	52,40
A0146B ...	850	1350	1	69,40
A0146C ...	1300	2200	1	102,90

## A0148

Tubo per doccia in ottone, ad angolo, composto da 2 attacchi a parete e 3 tubi Ø 2 cm, non estensibile  
 Brass shower rod, for corner, with 2 wall fixtures and 3 tubes Ø 2 cm, not extensible  
 Tringle de douche en laiton, en angle, composée de 2 fixations murales et 3 tubes Ø 2 cm, non extensible  
 Tubo para ducha de latón, angular, compuesto por 2 soportes a la pared y 3 tubos Ø 2 cm, no extensible

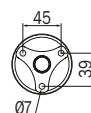
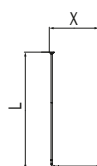

				CR
cod.	L	X	pz.	€
A0148A ...	836	836	1	92,10
A0148M ...	936	936	1	109,40
A0148B ...	1736	736	1	126,70

## A0148

Tubo per doccia in ottone, composto da 2 attacchi a parete e 1 tubo Ø 2 cm, non estensibile  
 Brass shower rod, with 2 wall fixtures and 1 tube Ø 2 cm, not extensible  
 Tringle de douche en laiton, composée de 2 fixations murales et 1 tube Ø 2 cm, non extensible  
 Tubo para ducha de latón, compuesto por 2 soportes a la pared y 1 tubo Ø 2 cm, no extensible

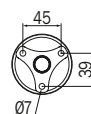

				CR
cod.	L	pz.	€	
A0148E ...	1000	1	54,10	
A0148G ...	2000	1	82,30	



**A0144**

NEW

Tubo per doccia in alluminio, tubo Ø 2 cm  
 Aluminium shower rod, Ø 2 cm  
 Tringle de douche en aluminium, tube Ø 2 cm  
 Tubo para ducha de aluminio, tubo Ø 2 cm

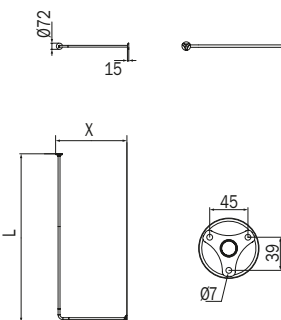

				AP
cod.	L	X	pz.	€
A0144A ...	800	800	1	55,40
A0144B ...	1700	700	1	68,30

**A01470**

Sostegno per tubo doccia a soffitto, in ottone, tubo Ø 2 cm  
 Support for ceiling shower rod, in brass, tube Ø 2 cm  
 Support pour tringle de douche au plafond, en laiton, tube Ø 2 cm  
 Soporte para tubo ducha, de techo, de latón, tubo Ø 2 cm

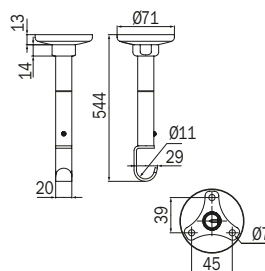

			CR
cod.	pz.	€	
A01470 ...	1	58,60	

**A05480**

Curva in ottone cromato per artt. A0148A - A0148B - A0148M  
 Curve in chrome-plated brass for arts. A0148A - A0148B - A0148M  
 Coude en laiton chromé pour arts. A0148A - A0148B - A0148M  
 Curva de latón cromado para art. A0148A - A0148B - A0148M

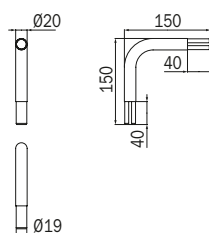

			CR 003
cod.	pz.	€	
A05480 ...	1	16,10	

## COMPLEMENTI DOCCIA / COMPLEMENTS / COMPLÉMENTS / COMPLEMENTOS

### AVOVNO

Tergivetro, doppio sistema di fissaggio: a parete o su vetro

Glass wiper, 2 fixings sets: wall-mounted or glass walls

Raclette, 2 systèmes de fixation : installation murale ou sur le verre de la paroi de douche

Limpia cristales, 2 sistemas de fijación: instalación de pared o para paredes de vidrio

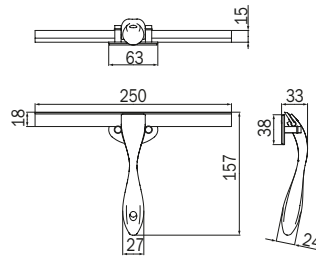

cod.	pz.	€
AVOVNO	1	42,70

### A02591QD

Tenda in poliestere (PE) impermeabilizzato, tinta unita con 8 ganci

Curtain in waterproofed polyester (PE), plain colour with 8 hooks

Rideau en polyestère (PE) imperméabilisé, couleur unie avec 8 crochets

Cortina de poliéster (PE) impermeabilizado, color único, con 8 ganchos

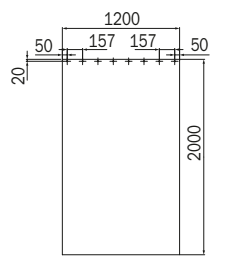

cod.	pz.	€
A02591QD	1	74,70

### A02592QD

Tenda in poliestere (PE) impermeabilizzato, tinta unita con 12 ganci

Curtain in waterproofed polyester (PE), plain colour with 12 hooks

Rideau en polyestère (PE) imperméabilisé, couleur unie avec 12 crochets

Cortina de poliéster (PE) impermeabilizado, color único, con 12 ganchos

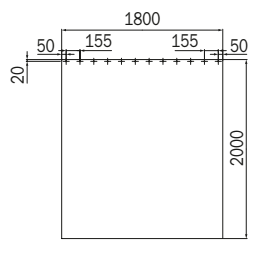

cod.	pz.	€
A02592QD	1	207,90

**A02593QD**

Tenda in poliestere (PE) impermeabilizzato, tinta unita con 16 ganci  
 Curtain in waterproofed polyester (PE), plain colour with 16 hooks  
 Rideau en polyester (PE) imperméabilisé, couleur unie avec 16 crochets  
 Cortina de poliéster (PE) impermeabilizado, color único, con 16 ganchos

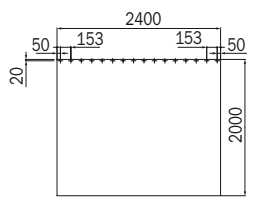

cod.	pz.	€
<b>A02593QD</b>	1	134,40

**A0259AQA**

Tenda in poliestere (PE) impermeabilizzato, tinta unita, senza ganci, sacchetto non appendibile  
 Curtain in waterproofed polyester (PE), plain colour, without hooks, bag packing not for hanging  
 Rideau en polyester (PE) imperméabilisé, couleur unie, sans crochets, sachet non crochetable  
 Cortina de poliéster (PE) impermeabilizado, color único, sin ganchos, bolsa no colgable

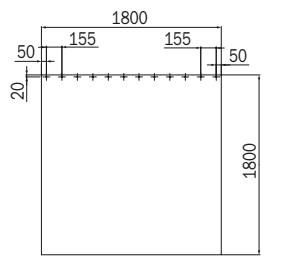

cod.	pz.	€
<b>A0259AQA</b>	1	73,70

**A0263AQA**

Tenda in poliestere (PE) impermeabilizzato, tinta unita, ignifuga, senza ganci, sacchetto non appendibile  
 Curtain in waterproofed polyester (PE), plain colour, fireproof, without hooks, bag packing not for hanging  
 Rideau en polyester (PE) imperméabilisé, couleur unie, ignifuge, sans crochets, sachet non crochetable  
 Cortina de poliéster (PE) impermeabilizado, color único, ignífuga, sin ganchos, bolsa no colgable

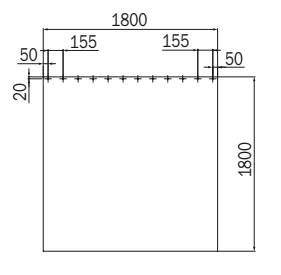

cod.	pz.	€
<b>A0263AQA</b>	1	134,40



**COMPLEMENTI DOCCIA / COMPLEMENTS / COMPLÉMENTS / COMPLEMENTOS**
**A0198B**

Tappetino doccia in gomma, antiscivolo  
 Shower mat in rubber, anti-slip  
 Tapis de douche en caoutchouc, antidérapant  
 Alfombrilla para ducha de goma, antideslizante

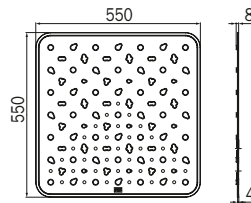

cod.	pz.	€
A0198B ...	1	37,30

**WW 005**
**A0199B**

Tappetino doccia in gomma, antiscivolo  
 Shower mat in rubber, anti-slip  
 Tapis de douche en caoutchouc, antidérapant  
 Alfombrilla para ducha de goma, antideslizante

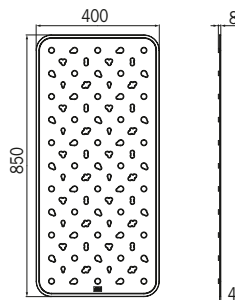

cod.	pz.	€
A0199B ...	1	37,30

**WW 005**



Complementi doccia / Complements  
Complements / Complementos

# TABLETOP SERIES



## SERIE DA APPOGGIO TABLETOP SERIES SÉRIES À POSER SERIES DE APOYO

- IT Accessori dal design contemporaneo, essenziale e dalle forme semplici e facili da pulire, curati nei dettagli e abbinabili perfettamente a tutte le Serie Inda.
- EN Accessories with a contemporary design, essential and simple shapes that are easy to clean, with attention to detail and perfectly suited to all Inda series.
- FR Accessoires avec un design contemporain, des formes essentielles et simples qui sont faciles à nettoyer, avec une attention aux détails et parfaitement adaptés à toutes les séries Inda.
- ES Accesorios con un diseño contemporáneo, esenciales y de formas simples que son fáciles de limpiar, con atención al detalle y perfectamente sincronizado con todas las series Inda.



## SERIE DA APPOGGIO / TABLETOP SERIES / SÉRIES À POSER / SERIES DE APOYO

### A2012Z

NEW

Spandisapone da appoggio, con contenitore in vetro ed erogatore in finitura  
 Tabletop soap dispenser with glass container and pump in finishing  
 Distributeur de savon à poser avec pot en verre et doseur en finition  
 Dosificador de jabón líquido de apoyo con recipiente de vidrio y dispensador en acabado

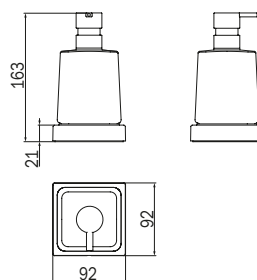

0,25 Lt.

cod.	pz.	CR 03 CR 21		NE 03 NE 21	
		€	€	€	€
A2012Z ...	1	79,20		89,30	

### A2010Z

NEW

Portabicchiere da appoggio con bicchiere in vetro  
 Tabletop tumbler holder with glass tumbler  
 Porte-verre à poser avec verre en verre  
 Portavasos de apoyo con vaso de vidrio

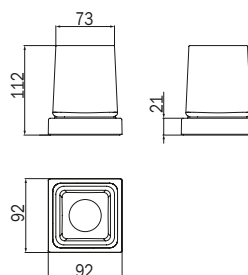

cod.	pz.	CR 03 CR 21		NE 03 NE 21	
		€	€	€	€
A2010Z ...	1	63,90		72,10	

### A2011Z

NEW

Portasapone da appoggio con bacinella in vetro  
 Tabletop soap holder with glass dish  
 Porte-savon à poser avec coupelle en verre  
 Jabonera de apoyo con cubeta de vidrio

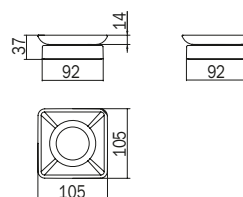

cod.	pz.	CR 03 CR 21		NE 03 NE 21	
		€	€	€	€
A2011Z ...	1	58,60		66,10	



**A1812Z**

Spandisapone da appoggio, con contenitore in vetro satinato ed erogatore in finitura  
 Tabletop soap dispenser with satined glass container and pump in finishing  
 Distributeur de savon à poser avec pot en verre satiné et doseur en finition  
 Dosificador de jabón líquido de apoyo con recipiente de vidrio satinado y dispensador en acabado

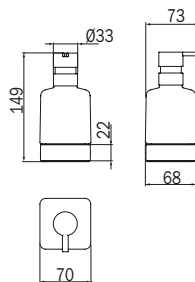

0,25 Lt.

		CR 21	NE 21 WM 21	AC 21	BZ 21 DR 21	CG 21 OR 21
<b>cod.</b>	<b>pz.</b>	€	€	€	€	€
<b>A1812Z ...</b>	1	43,30	49,90	60,80	69,70	78,10

**A1810Z**

Portabicchiere da appoggio con bicchiere in vetro satinato  
 Tabletop tumbler holder with satined glass tumbler  
 Porte-verre à poser, avec verre en verre satiné  
 Portavasos de apoyo con vaso de vidrio satinado

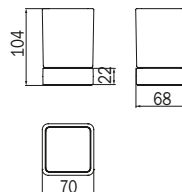

		CR 21	NE 21 WM 21	AC 21	BZ 21 DR 21	CG 21 OR 21
<b>cod.</b>	<b>pz.</b>	€	€	€	€	€
<b>A1810Z ...</b>	1	28,60	32,80	40,10	45,80	51,60

**A1811Z**

Portasapone da appoggio con bacinella in vetro satinato  
 Tabletop soap holder with satined glass dish  
 Porte-savon à poser, avec coupelle en verre satiné  
 Jabonera de apoyo con cubeta de vidrio satinado

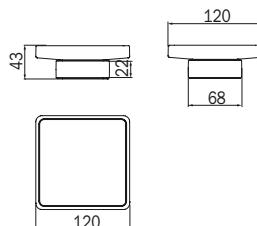

		CR 21	NE 21 WM 21	AC 21	BZ 21 DR 21	CG 21 OR 21
<b>cod.</b>	<b>pz.</b>	€	€	€	€	€
<b>A1811Z ...</b>	1	28,60	32,80	40,10	45,80	51,60

## SERIE DA APPOGGIO / TABLETOP SERIES / SÉRIES À POSER / SERIES DE APOYO

### A20060

Spandisapone da appoggio, con contenitore in vetro satinato ed erogatore in finitura  
 Tabletop soap dispenser with satined glass container and pump in finishing  
 Distributeur de savon à poser avec pot en verre satiné et doseur en finition  
 Dosificador de jabón líquido de apoyo con recipiente de vidrio satinado y dispensador en acabado

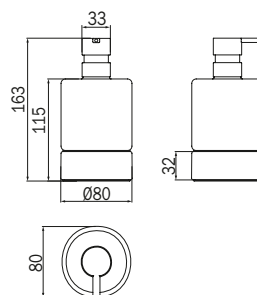

0,35 Lt.

		CR 21	NE 21 WM 21	AC 21
<b>cod.</b>	<b>pz.</b>	€	€	€
<b>A20060 ...</b>	1	61,30	76,70	86,20

### A20010

Portabicchiere da appoggio con bicchiere in vetro satinato  
 Tabletop tumbler holder with satined glass tumbler  
 Porte-verre à poser, avec verre en verre satiné  
 Portavasos de apoyo con vaso de vidrio satinado

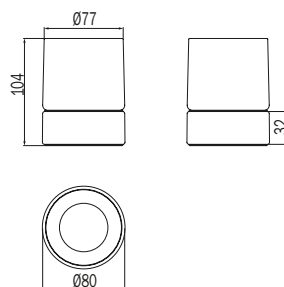

		CR 21	NE 21 WM 21	AC 21
<b>cod.</b>	<b>pz.</b>	€	€	€
<b>A20010 ...</b>	1	41,40	47,70	53,90

### A20020

Portasapone da appoggio con bacinella in vetro satinato  
 Tabletop soap holder with satined glass dish  
 Porte-savon à poser, avec coupelle en verre satiné  
 Jabonera de apoyo con cubeta de vidrio satinado

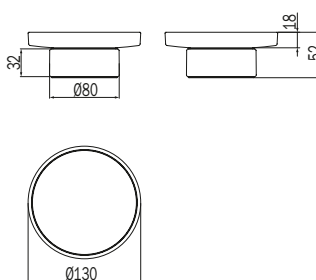

		CR 21	NE 21 WM 21	AC 21
<b>cod.</b>	<b>pz.</b>	€	€	€
<b>A20020 ...</b>	1	41,40	47,70	53,90

**A4667Z**

Spandisapone da appoggio con contenitore in vetro satinato, erogatore in ottone cromato  
 Tabletop soap dispenser with satined glass container and chrome-plated brass pump  
 Distributeur de savon à poser avec pot en verre satiné, doseur en laiton chromé  
 Dosificador de jabón líquido de apoyo con recipiente de vidrio satinado, dispensador de latón cromado

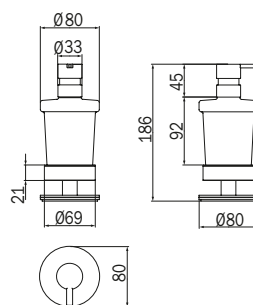

0,25 Lt.

		CR 21
cod.	pz.	€
A4667Z ...	1	125,60

**A4610Z**

Portabicchiere da appoggio con bicchiere in vetro satinato  
 Tabletop tumbler, with satined glass tumbler  
 Porte-verre à poser avec verre en verre satiné  
 Portavasos de apoyo con vaso de vidrio satinado

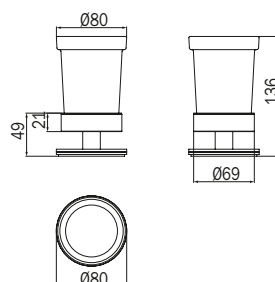

		CR 21
cod.	pz.	€
A4610Z ...	1	99,80

**A4611Z**

Portasapone da appoggio con bacinella in vetro satinato  
 Tabletop soap holder with satined glass dish  
 Porte-savon à poser avec coupelle en verre satiné  
 Jabonera de apoyo con cubeta de vidrio satinado

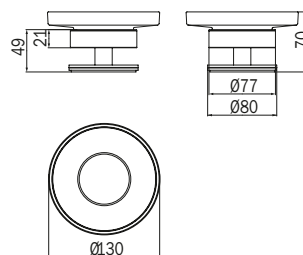

		CR 21
cod.	pz.	€
A4611Z ...	1	101,80

**SERIE DA APPOGGIO / TABLETOP SERIES / SÉRIES À POSER / SERIES DE APOYO**
**AV1060**
**NEW**

Spandisapone da appoggio  
 Tabletop soap dispenser  
 Distributeur de savon à poser  
 Dosificador de jabón líquido de apoyo

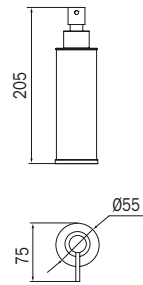

		CR
<b>cod.</b>	<b>pz.</b>	€
<b>AV1060 ...</b>	1	66,00

**AV1010**
**NEW**

Bicchiere da appoggio  
 Tabletop tumbler  
 Verre à poser  
 Vaso de apoyo

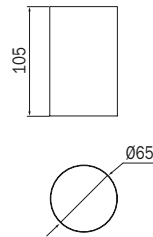

		AL
<b>cod.</b>	<b>pz.</b>	€
<b>AV1010 ...</b>	1	37,00

**A00060**

Spandisapone da appoggio  
 Tabletop soap dispenser  
 Distributeur de savon à poser  
 Dosificador de jabón líquido de apoyo

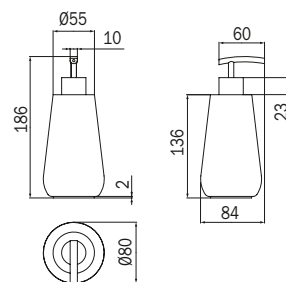

		AL
<b>cod.</b>	<b>pz.</b>	€
<b>A00060 ...</b>	1	53,60

**A00010**

Portabicchiere da appoggio  
 Tabletop tumbler holder  
 Porte-verre à poser  
 Portavasos de apoyo

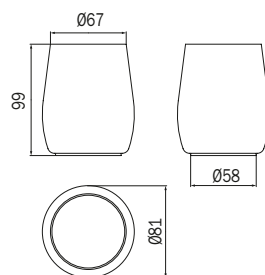

		AL	
cod.	pz.	€	
A00010 ...	1	32,20	

**A00020**

Portasapone da appoggio  
 Tabletop soap holder  
 Porte-savon à poser  
 Jabonera de apoyo

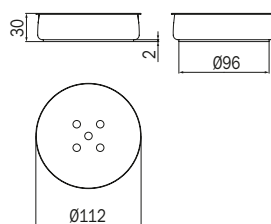

		AL	
cod.	pz.	€	
A00020 ...	1	34,70	

**AV0710**

Portakleenex da appoggio in ABS  
 Tabletop kleenex dispenser in ABS  
 Distributeur de mouchoirs en papier à poser en ABS  
 Distribuidor de pañuelos de papel de apoyo de ABS

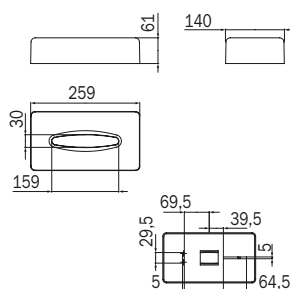

		CR		NE	
cod.	pz.	€		€	
AV0710 ...	1	45,40		52,20	

# SPARE PARTS

## RICAMBI SPARE PARTS PIÈCES DE RECHANGE REPUESTOS

- IT Inda, attenta alle necessità del cliente, mantiene una vasta gamma di ricambi per soddisfare differenti esigenze di modifica o sostituzione di ogni elemento di cui è composto l'articolo.
- EN Inda, focused on customer needs, assures a wide range of spare parts to satisfy the most diverse requirements of modification or replacement of every element of an article.
- FR Inda, à l'écoute des besoins des clients, maintient une large gamme de pièces détachées pour répondre aux différents besoins de modification ou de remplacement de chaque élément dont l'article est composé.
- ES Inda, atenta a las necesidades del cliente, mantiene una amplia gama de repuestos para cubrir las distintas necesidades de modificación o reposición de cada elemento que compone el artículo.



## RICAMBI / SPARE PARTS / PIÉCES DE RECHARGE / REPUESTOS

### R46110

Bacinella in vetro satinato per artt.  
Satin cup for arts.  
Coupelle satiné pour arts.  
Cubeta de vidrio satinado para art.

A46110 - A4611Z - A20110

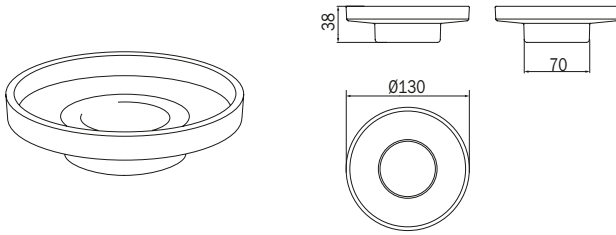

cod.	pz.	€
R46110	1	23,90

### R46110001

Bacinella in vetro trasparente per artt.  
Dish in extra clean transparent glass for arts.  
Coupelle en verre transparent pour arts.  
Cubeta de vidrio transparente para art.

A24110 - A10110

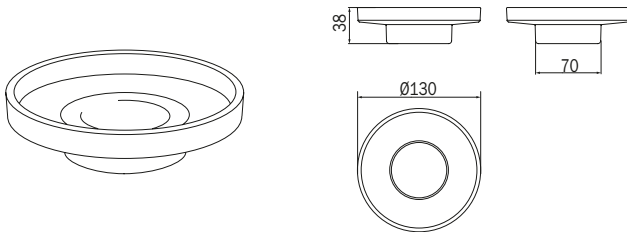

cod.	pz.	€
R46110001	1	20,30

### R1511B001

Bacinella in vetro trasparente per artt.  
Dish in extra clean transparent glass for arts.  
Coupelle en verre transparent pour arts.  
Cubeta de vidrio transparente para art.

A2011Z - A15100

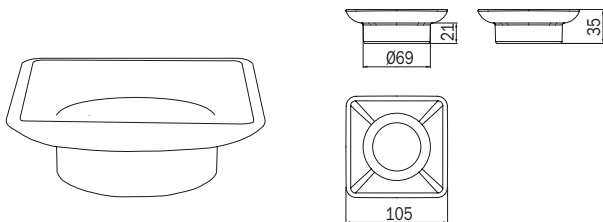

cod.	pz.	€
R1511B001	1	29,90

### R1511B002

Bacinella in vetro satinato per artt.  
Satin cup for arts.  
Coupelle satiné pour arts.  
Cubeta de vidrio satinado para art.

A2011Z - A15100

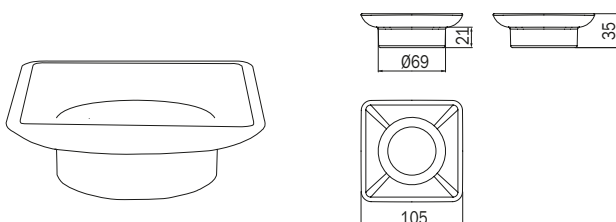

cod.	pz.	€
R1511B002	1	29,90



**R1811N**

Bacinella in vetro satinato per artt.  
Dish in satined glass for arts.  
Coupelle en verre satiné pour arts.  
Cubeta de vidrio satinado para art.

A18110 - A1811Z

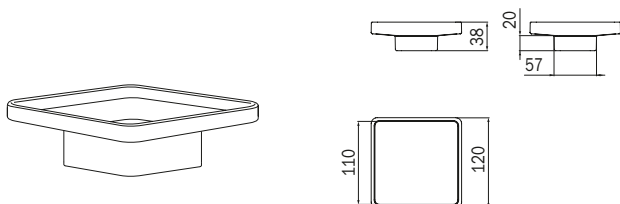

cod.	pz.	€
<b>R1811N</b>	1	19,80

**R76110**

Bacinella in vetro satinato per artt.  
Dish in satined glass for arts.  
Coupelle en verre satiné pour arts.  
Cubeta de vidrio satinado para art.

A36110 - A30110

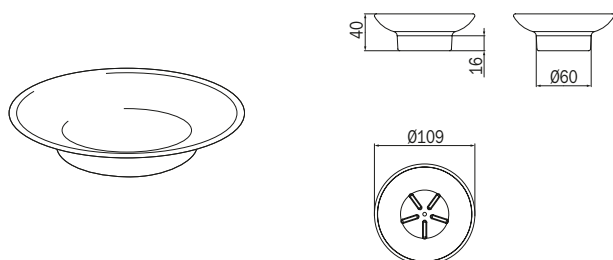

cod.	pz.	€
<b>R76110</b>	1	10,00

**R32110**

Bacinella in vetro satinato per artt.  
Dish in satined glass for artt.  
Coupelle en verre satiné pour arts.  
Cubeta de vidrio satinado para art.

A32110

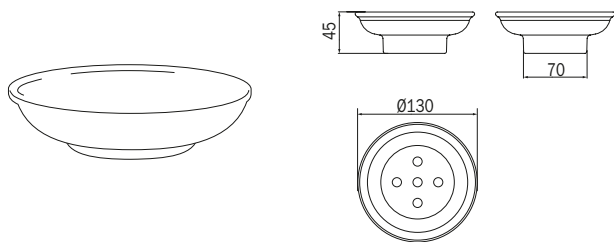

cod.	pz.	€
<b>R32110</b>	1	28,10

**R32110001**

Bacinella in ceramica bianca per artt.  
Dish in white ceramic for artt.  
Coupelle en céramique blanche pour artt.  
Cubeta de cerámica blanca para artt.

A32110

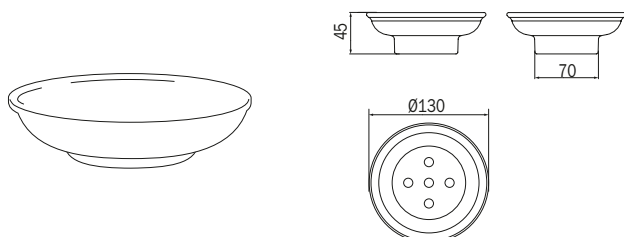

cod.	pz.	€
<b>R32110001</b>	1	28,40

# RICAMBI / SPARE PARTS / PIÉCES DE RECHARGE / REPUESTOS

## R03110

Bacinella in vetro extrachiaro trasparente per art.  
Extra clear transparent glass dish for art.  
Coupelle en verre transparent extra clair pour art.  
Cubeta de vidrio transparente extraclaro para art.

A23110 - A2310N

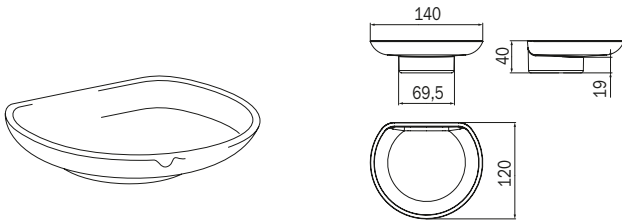

cod.	pz.	€
<b>R03110</b>	1	20,10

## R01110

Bacinella in PMMA per artt.  
PMMA dish for arts.  
Coupelle en PMMA pour arts.  
Cubeta en PMMA para art.

A23110 - A2310N

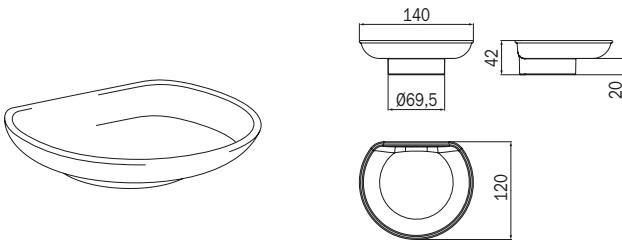

cod.	pz.	€
<b>R01110</b>	1	5,40

## R8810M

Bicchiere per modulo portabicchiere in finitura NS per art.  
Glass for cup holder module in finish NS for art.  
Verre pour module porte-gobelet en finition NS pour l'art.  
Vaso para mòdulo portavaso en acabado NS para art.

A8810MNS

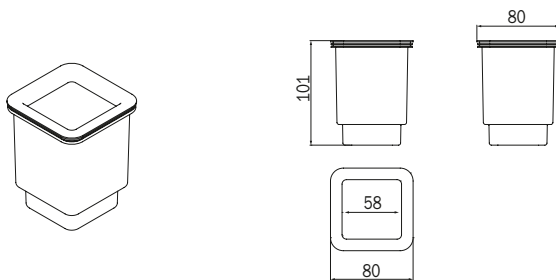

cod.	pz.	€
<b>R8810M</b>	1	32,20

## R8810M001

Bicchiere per modulo portabicchiere in finitura NE per art.  
Glass for cup holder module in finish NE for art.  
Verre pour module porte-gobelet en finition NE pour l'art.  
Vaso para mòdulo portavaso en acabado NE para art.

A8810MNE

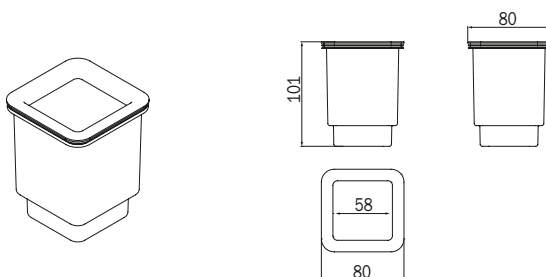

cod.	pz.	€
<b>R8810M001</b>	1	34,30

- R8810M002** Bicchiere per modulo portabicchiere in finitura WM per art. A8810MWM  
 Glass for cup holder module in finish WM for art.  
 Verre pour module porte-gobelet en finition WM pour l'art.  
 Vaso para mòdulo portavaso en acabado WM para art.

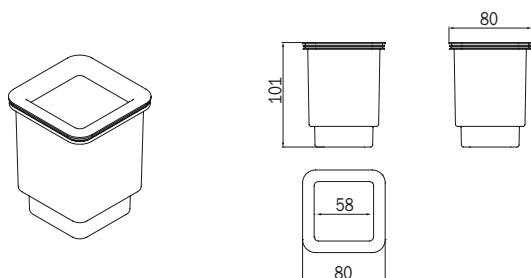

cod.	pz.	€
<b>R8810M002</b>	1	34,30

- R1510B001** Bicchiere in vetro trasparente extrachiaro per art. A2010Z - A15110  
 Tumbler in extra clear transparent glass for arts.  
 Verre en verre transparent extra clair pour arts.  
 Vaso de vidrio extraclaro transparente para art.

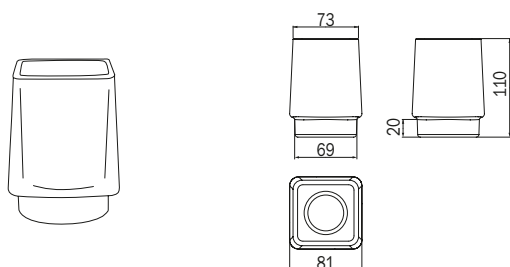

cod.	pz.	€
<b>R1510B001</b>	1	35,70

- R1510B002** Bicchiere in vetro satinato per art. A2010Z - A15110  
 Tumbler in satinèd glass for arts.  
 Verre en verre satiné pour arts.  
 Vaso de vidrio satinado para art.

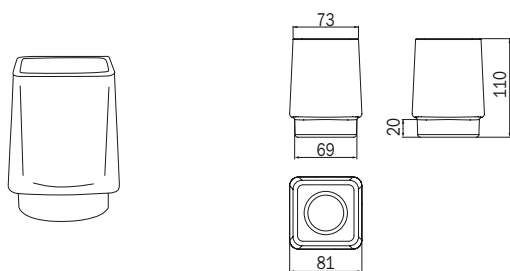

cod.	pz.	€
<b>R1510B002</b>	1	35,70

- R46100001** Bicchiere in vetro trasparente extrachiaro per art. A2410A - A1010A  
 Tumbler in extra clear transparent glass for arts.  
 Verre en verre transparent extra clair pour arts.  
 Vaso de vidrio extraclaro transparente para art.

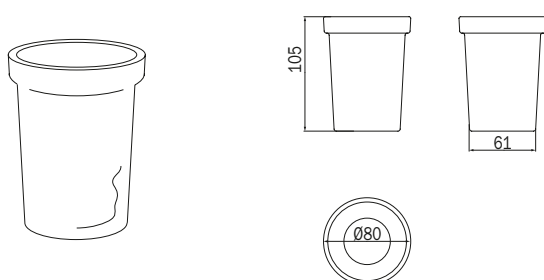

cod.	pz.	€
<b>R46100001</b>	1	20,30

# RICAMBI / SPARE PARTS / PIÈCES DE RECHARGE / REPUESTOS

## R46100

Bicchiere in vetro satinato per artt.  
Tumbler in satined glass for arts.  
Verre en verre satiné pour arts.  
Vaso de vidrio satinado para art.

A46100 - A4610Z

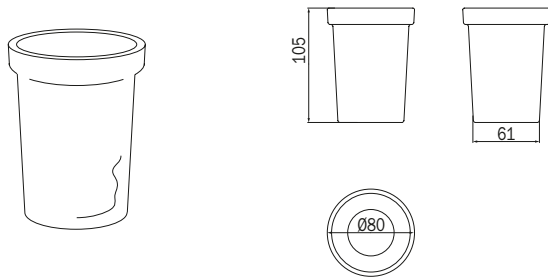

cod.	pz.	€
<b>R46100</b>	1	23,30

## R00100007

Bicchiere in vetro satinato per artt.  
Tumbler in satined glass for arts.  
Verre en verre satiné pour art.  
Vaso de vidrio satinado para art.

A20100

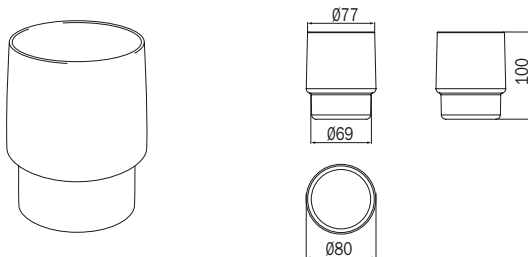

cod.	pz.	€
<b>R00100007</b>	1	18,00

## R1810N

Bicchiere in vetro satinato per artt.  
Tumbler in satined glass for arts.  
Verre en verre satiné pour art.  
Vaso de vidrio satinado para art.

A18100 - A1810Z - A1810F - A1810D - A8810N

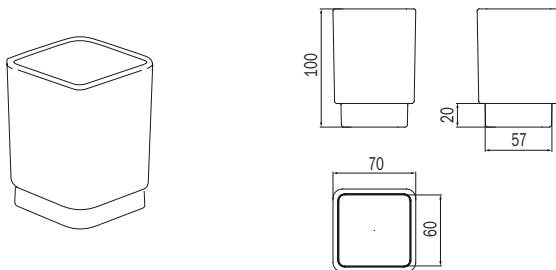

cod.	pz.	€
<b>R1810N</b>	1	19,80

## R76100

Bicchiere in vetro satinato per artt.  
Tumbler in satined glass for arts.  
Verre en verre satiné pour art.  
Vaso de vidrio satinado para art.

A36100 - A3610D - A30100 - A3010D

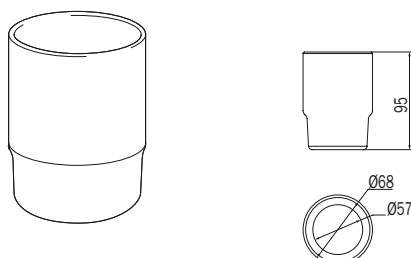

cod.	pz.	€
<b>R76100</b>	1	10,00

**R32100**

Bicchiere in vetro satinato per art.  
Tumbler in satined glass for art.  
Verre en verre satiné pour art.  
Vaso de vidrio satinado para art.

A32100

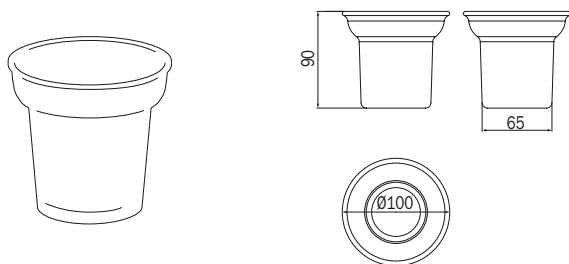

cod.	pz.	€
<b>R32100</b>	1	32,10

**R32100003**

Bicchiere in ceramica bianca per art.  
Tumbler in white ceramic for art.  
Verre en céramique blanche pour art.  
Vaso de cerámica blanca para art.

A32100BZ07

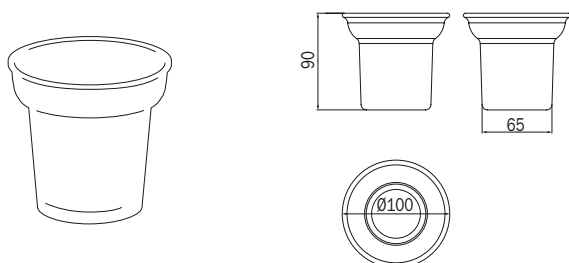

cod.	pz.	€
<b>R32100003</b>	1	32,50

**R00100**

Bicchiere in vetro satinato per art.  
Tumbler in satined glass for art.  
Verre en verre satiné pour art.  
Vaso de vidrio satinado para art.

A20100

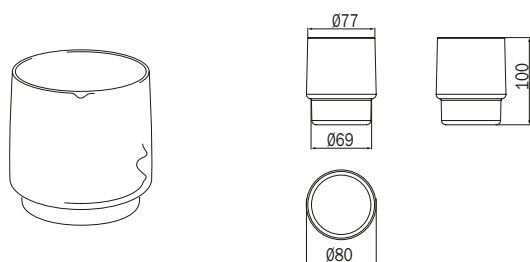

cod.	pz.	€
<b>R00100</b>	1	20,20

**R03600**

Bicchiere in vetro trasparente extrachiario per artt.  
Tumbler in extra clear transparent glass for arts.  
Verre en verre transparent extra clair pour arts.  
Vaso de vidrio extraclaro transparente para art.

A23100 - A2310N - A04100 - A0410N

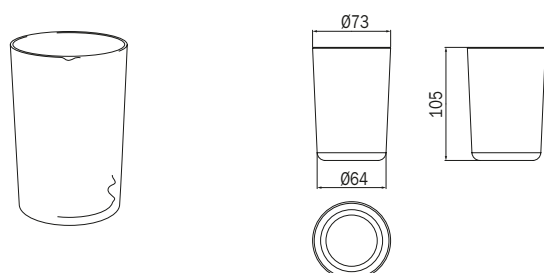

cod.	pz.	€
<b>R03600</b>	1	12,80

# RICAMBI / SPARE PARTS / PIÈCES DE RECHARGE / REPUESTOS

## R01100

Bicchiere in PMMA per artt.  
PMMA tumbler for arts.  
Verre en PMMA pour les arts.  
Vaso en PMMA para los art.

A2310N - A0410N - A2317N

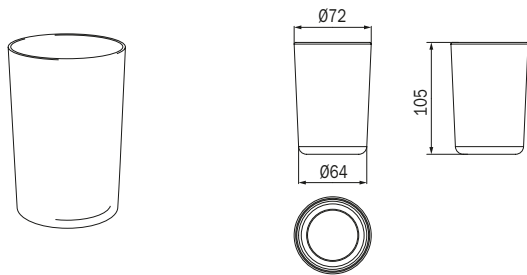

cod.	pz.	€
<b>R01100</b>	1	5,40

## R46670001

Contenitore in vetro trasparente extrachiaro per artt.  
Container in extra clear transparent glass for arts.  
Récipient en verre transparent extra clair pour arts.  
Recipiente de vidrio extraclaro transparente para art.

A24120 - A10120 - AV085G - AV085E - AV086F - AV086G

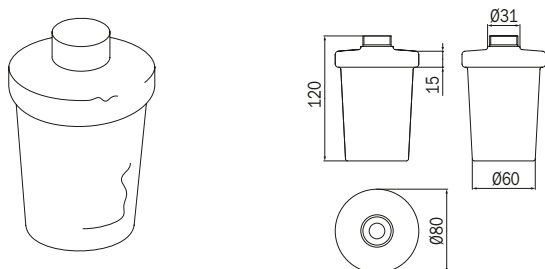

cod.	pz.	€
<b>R46670001</b>	1	29,70

## R46670

Contenitore in vetro satinato per artt.  
Container in satined glass for arts.  
Récipient en verre satiné pour arts.  
Recipiente de vidrio satinado para art.

A46670 - A4667Z - A4667A - A20120

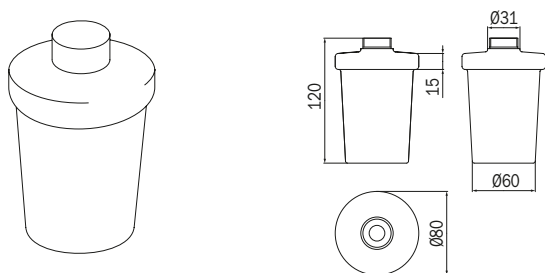

cod.	pz.	€
<b>R46670</b>	1	36,50

## R1512B

Contenitore in vetro satinato per artt.  
Container in satined glass for arts.  
Récipient en verre satiné pour arts.  
Recipiente de vidrio satinado para art.

A2012Z - A15120

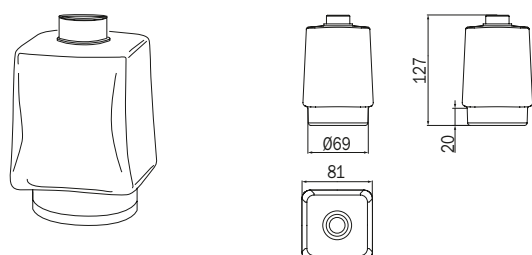

cod.	pz.	€
<b>R1512B</b>	1	29,00

**R1512B004** Contenitore in vetro trasparente extrachiario per artt.  
 Container in extra clear transparent glass for arts.  
 Récipient en verre transparent extra clair pour arts.  
 Recipiente de vidrio extraclaro transparente para art.

A2012Z - A15120

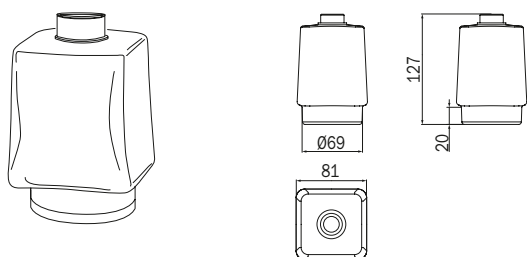

cod.	pz.	€
<b>R1512B004</b>	1	29,00

**R1812N** Contenitore in vetro satinato per artt.  
 Container in satined glass for arts.  
 Récipient en verre satiné pour arts.  
 Recipiente de vidrio satinado para art.

A18120 - A1812Z - A1810D

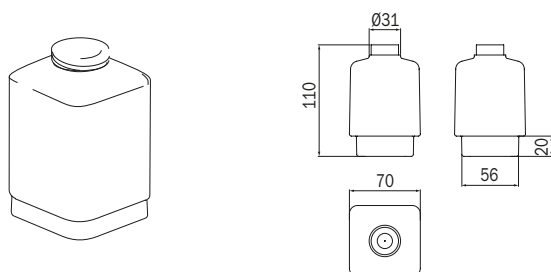

cod.	pz.	€
<b>R1812N</b>	1	20,30

**R76120** Contenitore in vetro satinato per artt.  
 Container in satined glass for arts.  
 Récipient en verre satiné pour arts.  
 Recipiente de vidrio satinado para art.

A36120 - A30120

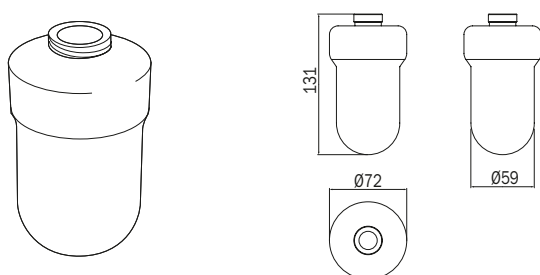

cod.	pz.	€
<b>R76120</b>	1	19,50

**R43670** Contenitore in vetro satinato per artt.  
 Container in satined glass for arts.  
 Récipient en verre satiné pour arts.  
 Recipiente de vidrio satinado para art.

A32120 - A2367A

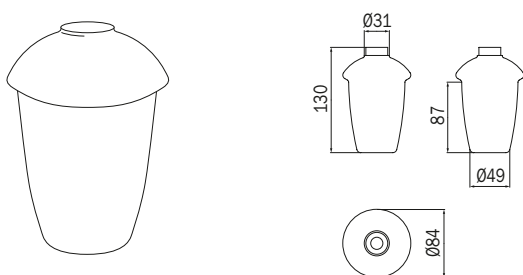

cod.	pz.	€
<b>R43670</b>	1	30,40

# RICAMBI / SPARE PARTS / PIÉCES DE RECHARGE / REPUESTOS

## R88670

Copriserbatorio in vetro satinato per artt.  
Satin glass tank cover for arts.  
Couvercle de réservoir en verre satiné pour arts.  
Cubierta de cristal satinado para art.

A88670/M/Z - A18670

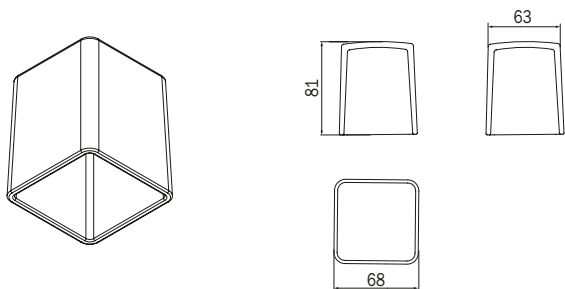

cod.	pz.	€
R88670	1	11,90

## R88120

Erogatore in ottone cromato per artt.  
Distributor in chromed-plated brass for arts.  
Distributeur en laiton chromé pour l'arts.  
Dispensador en latón cromado para art.

A88120/M/Z - A10120 - A20060 - A20120 - A1512Z - A15120 - A2012Z - A1812Z - A1810D - A18120 - A24120 - A46670 - A4667Z - A32120 - A2367A

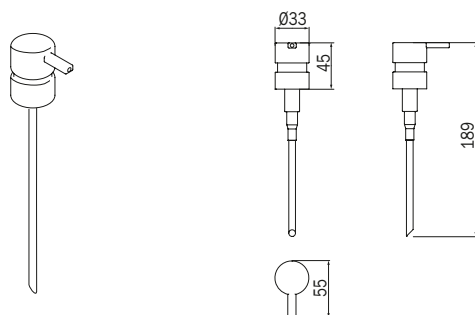

cod.	pz.	€
R88120	1	30,10

## R88120001

Erogatore in finitura NS per artt.  
Distributor in finish NS for arts.  
Distributeur en finition NS pour l'arts.  
Dispensador en acabado NS para art.

A88120/M/Z - A10120

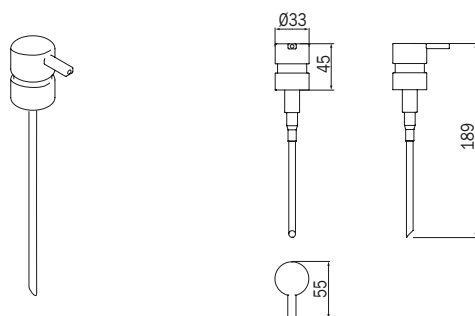

cod.	pz.	€
R88120001	1	32,20

## R88120002

Erogatore in finitura NE per artt.  
Distributor in finish NE for artt.  
Distributeur en finition NE pour l'arts.  
Dispensador en acabado NE para art.

A88120/M/Z - A20060 - A20120 - A1512Z - A15120 - A2012Z - A1812Z - A1810D - A18120 - A24120

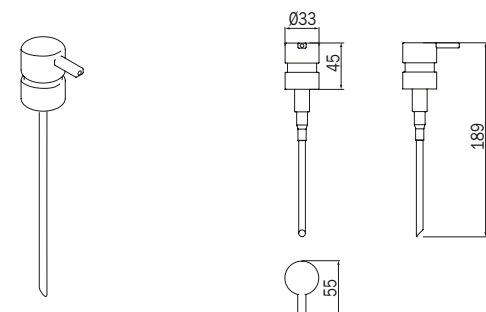

cod.	pz.	€
R88120002	1	48,30



**R88120003** Erogatore in finitura WM per artt.  
 Distributor in finish WM for arts.  
 Distributeur en finition WM pour l'arts.  
 Dispensador en acabado WM para art.

A88120/M/Z - A20060 - A20120 - A1512Z - A15120 - A2012Z - A1812Z -  
 A1810D - A18120 - A24120

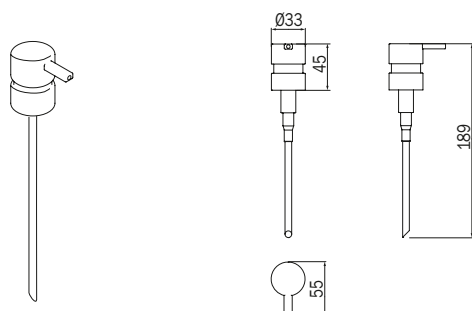

cod.	pz.	€
<b>R88120003</b>	1	48,30

**R01060001** Erogatore in ottone cromato per artt.  
 Dispenser in chrome-plated brass for arts.  
 Doseur en laiton chromé pour arts.  
 Dispensador en latón cromado para art

A46670 - A4667Z - A4667A - R1512B - A20120 - A2012Z - A10120 - A1810D  
 - A18120 - A1812Z - A32120 - A2367A - AV085G - AV085E - A24120CR

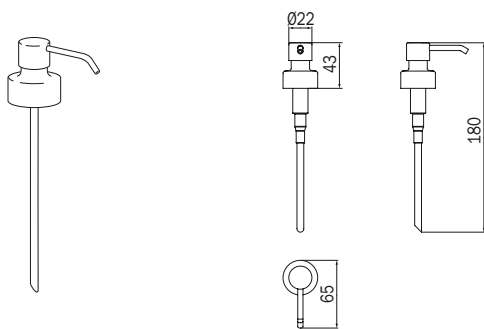

cod.	pz.	€
<b>R01060001</b>	1	24,40

**R01060002** Erogatore in nickel spazzolato per artt.  
 Brushed nickel dispenser brass for art.  
 Doseur en nickel brossé pour art.  
 Dispensador níquel cepillado para art.

A24120

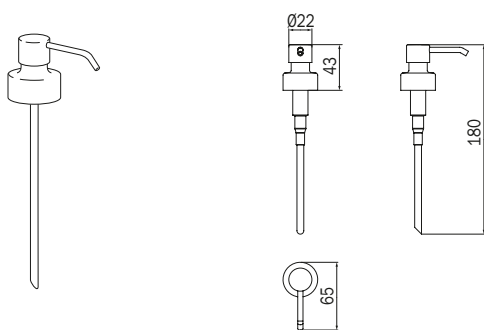

cod.	pz.	€
<b>R01060002</b>	1	25,60

**R01060003** Erogatore bronzato per artt.  
 Bronzed dispenser brass for art.  
 Doseur bronzé pour art.  
 Dispensador bronzado para art.

A24120

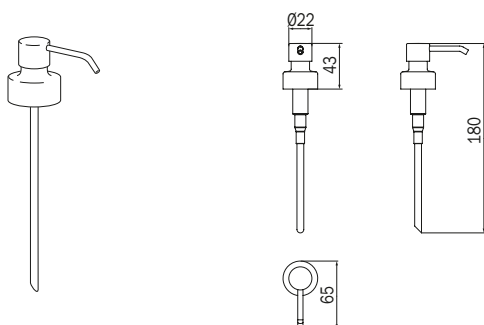

cod.	pz.	€
<b>R01060003</b>	1	30,20

# RICAMBI / SPARE PARTS / PIÉCES DE RECHARGE / REPUESTOS

**R01060004** Erogatore dorato per art.  
Gilded dispenser brass for art.  
Doseur doré pour art.  
Dispensador dorado para art.

A24120

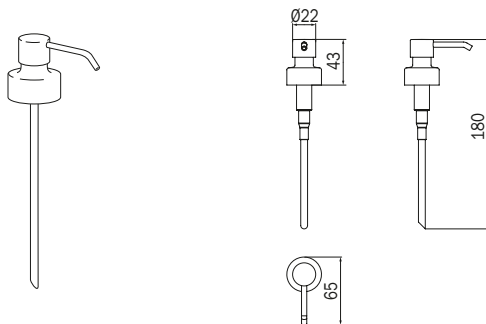

cod.	pz.	€
<b>R01060004</b>	1	30,20

**R01060005** Erogatore nero per art.  
Black dispenser brass for art.  
Doseur noir pour art.  
Dispensador negro para art.

A24120

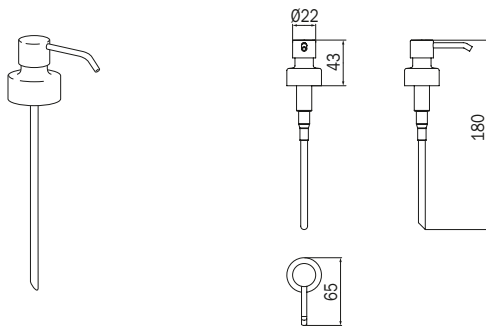

cod.	pz.	€
<b>R01060005</b>	1	31,40

**R76120001** Erogatore in ottone cromato per artt.  
Dispenser in chrome-plated brass for arts.  
Doseur en laiton chromé pour arts.  
Dispensador en latón cromado para art.

A36120 - A30120

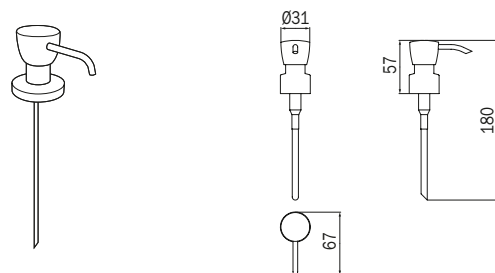

cod.	pz.	€
<b>R76120001</b>	1	30,80

**R0407A001** Erogatore in ottone cromato per artt.  
Dispenser in chrome-plated brass for artt.  
Doseur en laiton chromé pour artt.  
Dispensador en latón cromado para artt.

A0407A

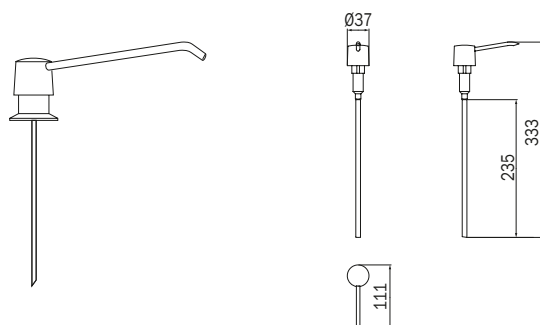

cod.	pz.	€
<b>R0407A001</b>	1	35,60

**R03290001** Rullo in ottone cromato per artt.  
 Chrome-plated brass roll for arts.  
 Dérouleur en laiton chromé pour arts.  
 Eje en latón cromado para art.

A1525A - A1826A - A8028D - A8029D

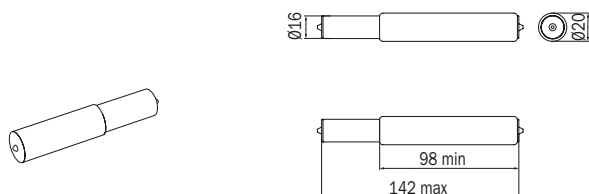

cod.	pz.	€
<b>R03290001</b>	1	15,70

**R03290** Rullo in plastica per artt.  
 Plastic roll for arts.  
 Dérouleur en plastique pour arts  
 Eje de plástico para art.

A23270 - A23260

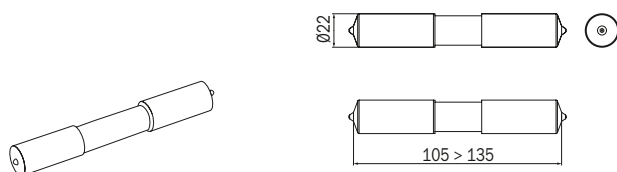

cod.	pz.	€
<b>R03290</b>	1	2,90

**RV014A003** Bacinella interna bianca per artt.  
 White internal basin for arts.  
 Coupelle intérieure blanche pour arts.  
 Cubeta interior blanca para art.

AV014A - A3814A

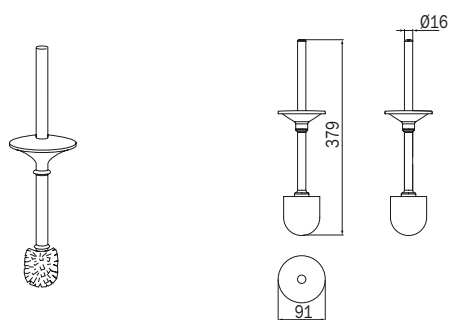

cod.	pz.	€
<b>RV014A003</b>	1	37,70

**RV014B003** Asta completa in ottone cromato con scovolo grigio per artt.  
 Grey brush with chrome-plated brass handle for artt.  
 Balayette complète en laiton chromé avec brosse grise pour artt.  
 Escobilla con mango en latón cromado con escobilla gris para artt.

AV014B

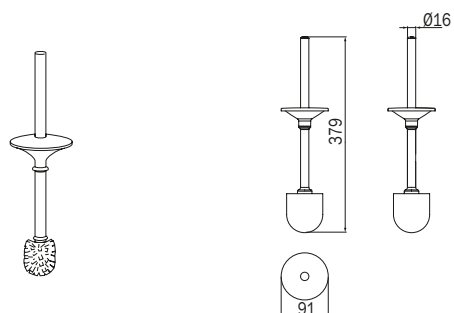

cod.	pz.	€
<b>RV014B003</b>	1	37,70

# RICAMBI / SPARE PARTS / PIÉCES DE RECHARGE / REPUESTOS

**R1814N001** Asta completa in ottone cromato per art.  
Brush with handle in chrome-plated brass for art.  
Balayette complète en laiton chromé pour art.  
Escobilla con mango en latón cromado para art.

A18140

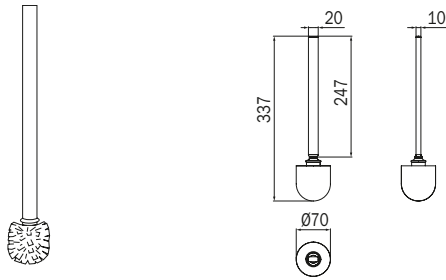

cod.	pz.	€
<b>R1814N001</b>	1	33,00

**R1814N005** Asta completa nera con scovolo nero per art.  
Black brush with black handle for art.  
Balayette complète noir avec brosse noir pour art.  
Escobilla con mango negra e con escobilla negra para art.

A1814B

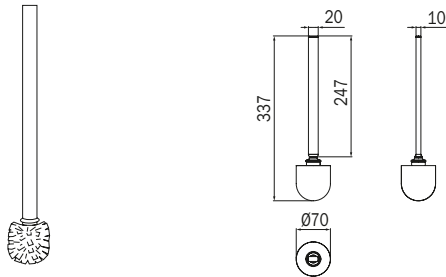

cod.	pz.	€
<b>R1814N005</b>	1	52,60

**R76140001** Asta completa per artt.  
Brush with handle for arts.  
Balayette complète pour arts.  
Escobilla con mango para art.

A36140 - A30140

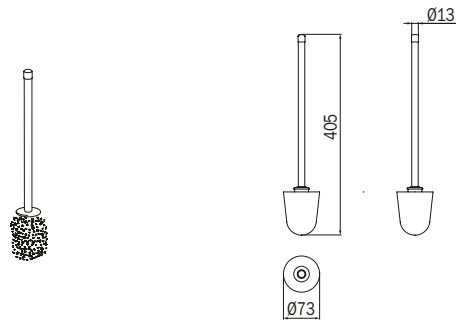

cod.	pz.	€
<b>R76140001</b>	1	22,30

**R37140** Asta completa in ottone cromato per artt.  
Brush with handle in chrome-plated brass for arts.  
Balayette complète en laiton chromé pour arts.  
Escobilla con mango en latón cromado para art.

A37140 - A32240

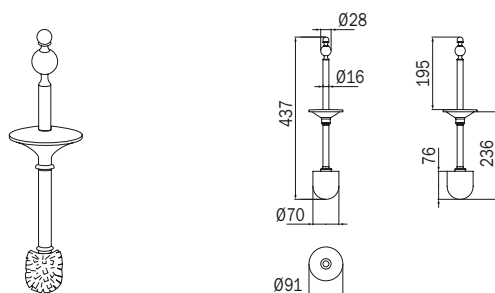

cod.	pz.	€
<b>R37140</b>	1	41,80

**RV014A030** Asta completa bianca con scovolo bianco per artt.  
White brush with white handle for arts.  
Balayette complète blanche avec brosse blanche pour arts.  
Escobilla con mango blanca e con escobilla blanca para art.

AV014A - A3814A

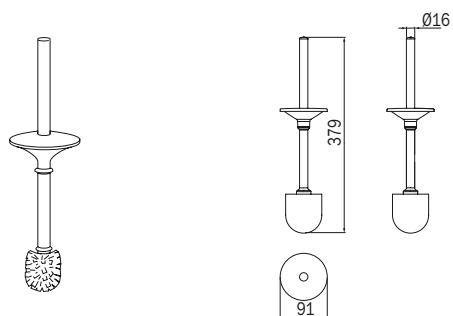

cod.	pz.	€
<b>RV014A030</b>	1	37,20

**R41140** Asta completa in ottone cromato per artt.  
Brush with handle in chrome-plated brass for artt.  
Balayette complète en laiton chromé pour artt.  
Escobilla con mango en latón cromado para artt.

A04140

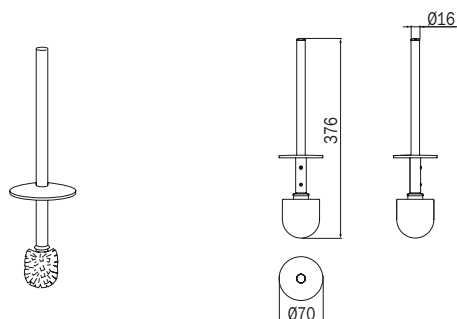

cod.	pz.	€
<b>R41140</b>	1	62,90

**R07140** Asta completa in ottone cromato per artt.  
Brush with handle in chrome-plated brass for artt.  
Balayette complète en laiton chromé pour artt.  
Escobilla con mango en latón cromado para artt.

A07140

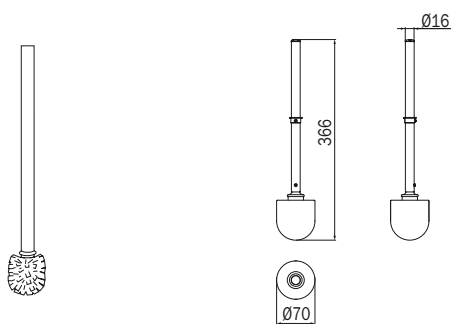

cod.	pz.	€
<b>R07140</b>	1	29,00

**R21140** Asta completa in ottone cromato per artt.  
Brush with handle in chrome-plated brass for arts.  
Balayette complète en laiton chromé pour arts.  
Escobilla con mango en latón cromado para artt.

A05140 - A0414A

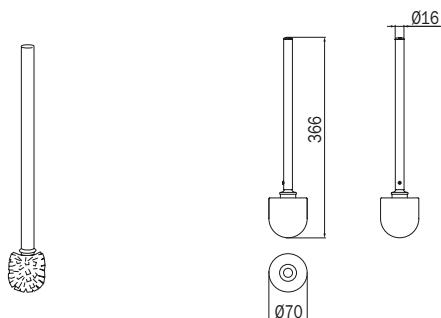

cod.	pz.	€
<b>R21140</b>	1	23,70

# RICAMBI / SPARE PARTS / PIÉCES DE RECHARGE / REPUESTOS

## RV8140

Asta completa in ottone cromato per art.  
Brush with handle in chrome-plated brass for art.  
Balayette complète en laiton chromé pour art.  
Escobilla con mango en latón cromado para art.

AV8140

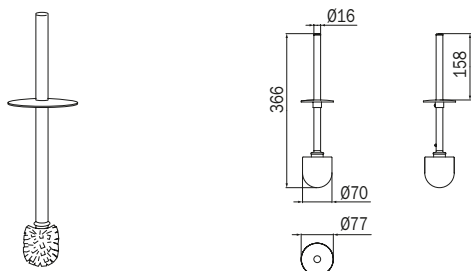

cod.	pz.	€
RV8140	1	36,70

## RV0140

Scovolo bianco per artt.  
White brush for arts.  
Brosse blanche pour arts.  
Escobilla blanca para art.

AV014A - A32240 - A3814A - A23240

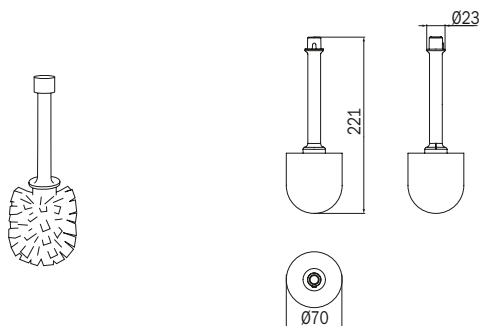

cod.	pz.	€
RV0140	1	11,20

## RV0140001

Scovolo bianco per artt. Confezione da 10 pz.  
White brush for arts. The packing contains 10 pcs.  
Brosse blanche pour arts. Lot de 10 pz.  
Escobilla blanca para art. Paquete de 10 piezas

AV014A - A3814A

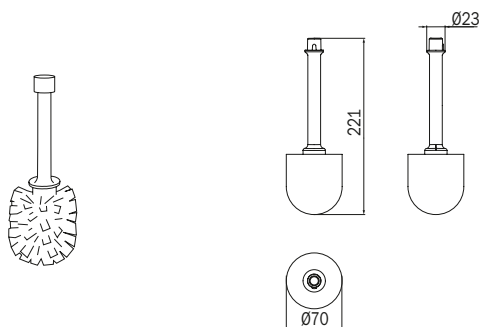

cod.	pz.	€
RV0140001	1	8,70

## RV014B

Scovolo grigio per art.  
Grey brush for art.  
Brosse grise pour art.  
Escobilla gris para art.

AV014B

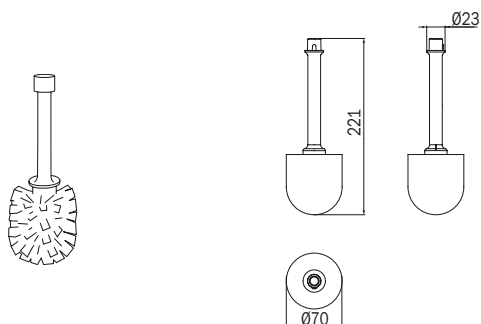

cod.	pz.	€
RV014B	1	11,20

**RV014B001** Scovolo grigio per art. Confezione da 10 pz.  
 Grey brush for art. The packing contains 10 pcs.  
 Brosse grise pour art. Lot de 10 pz.  
 Escobilla gris para art. Paquete de 10 piezas

AV014B

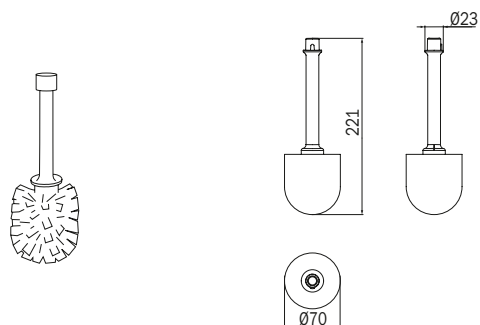

cod.	pz.	€
<b>RV014B001</b>	1	8,70

**RV114A002** Scovolo bianco per art.  
 White brush for art.  
 Brosse blanche pour art.  
 Escobilla blanca para art.

AV114A

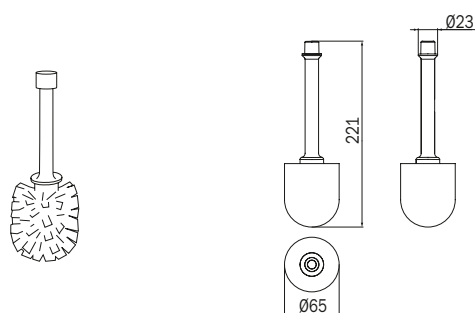

cod.	pz.	€
<b>RV114A002</b>	1	14,90

**R38140023** Scovolo bianco per artt.  
 White brush for arts.  
 Brosse blanche pour arts.  
 Escobilla blanca para art.

A0414A - A07140 - A05140 - A04140 - AV8140

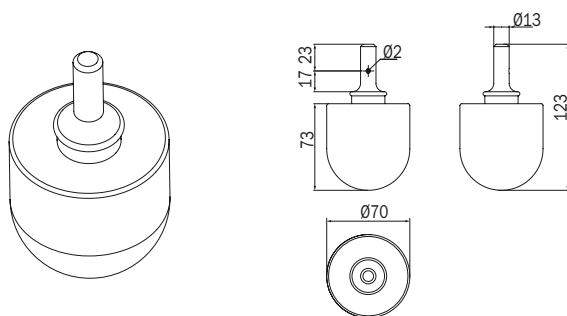

cod.	pz.	€
<b>R38140023</b>	1	8,90

**R38140033** Scovolo nero per artt.  
 Black brush for arts.  
 Brosse noir pour arts.  
 Escobilla negro para art.

A0414A - A07140 - A05140 - A04140 - AV8140

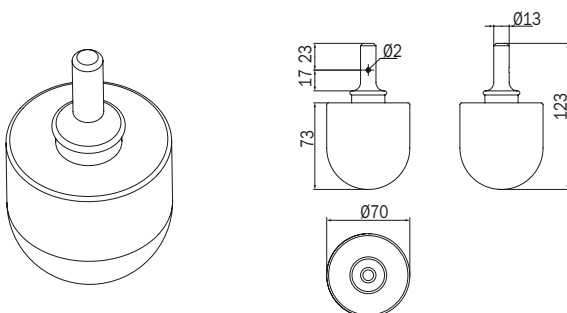

cod.	pz.	€
<b>R38140033</b>	1	8,90

**RICAMBI / SPARE PARTS / PIÉCES DE RECHARGE / REPUESTOS**

**R13140001** Scovolo bianco per art.  
White brush for art.  
Brosse blanche pour art.  
Escobilla blanca para art.

A18140

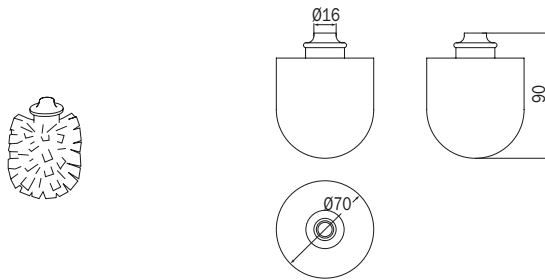

cod.	pz.	€
<b>R13140001</b>	1	7,60

**R1314B001** Scovolo nero per art.  
Black brush for art.  
Brosse noir pour art.  
Escobilla negro para art.

A1814B

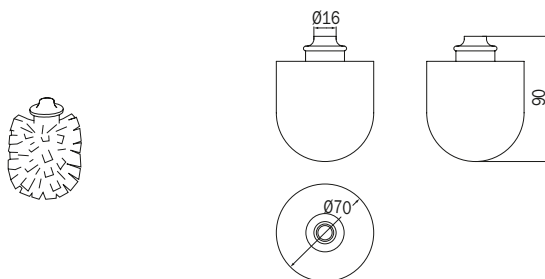

cod.	pz.	€
<b>R1314B001</b>	1	7,60

**R76140002** Scovolo bianco per art.  
White brush for art.  
Brosse blanche pour art.  
Escobilla blanca para art.

A36140

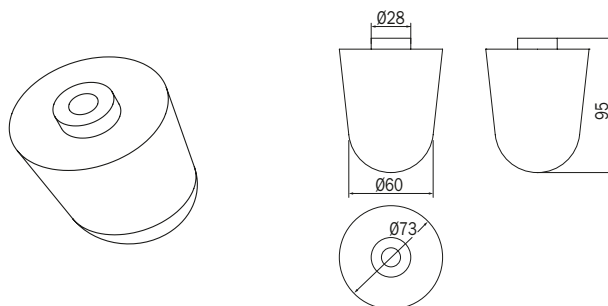

cod.	pz.	€
<b>R76140002</b>	1	10,00

**RV014A009** Bacinella interna bianca per artt.  
White internal dish for arts.  
Coupelle intérieur blanche pour arts.  
Cubeta interior blanca para art.

AV014A - A23240

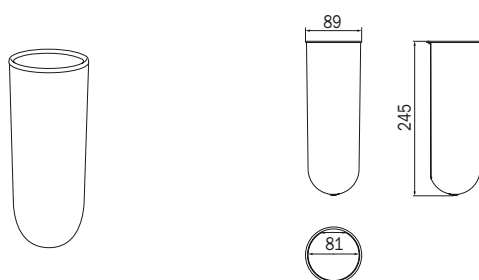

cod.	pz.	€
<b>RV014A009</b>	1	15,60



**RV014B004** Bacinella interna grigia per artt.  
 Grey internal dish for artt.  
 Coupelle intérieur grise pour artt.  
 Cubeta interior gris para artt.

AV014B

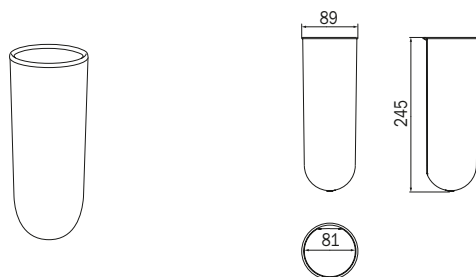

cod.	pz.	€
<b>RV014B004</b>	1	15,80

**RV014A005** Fondo in plastica trasparente per artt.  
 Base in transparent plastic for arts.  
 Bouchon de fermeture inférieure pour arts.  
 Cubeta de plástica transparente para artt.

AV014A - AV014B - A23240 - A32240

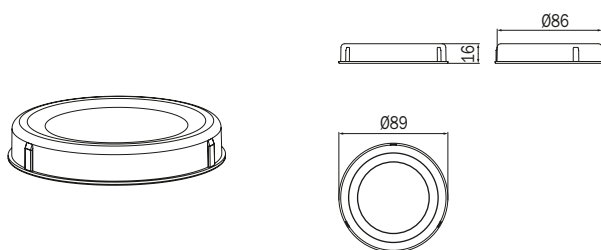

cod.	pz.	€
<b>RV014A005</b>	1	5,20

**R1814N** Bacinella in vetro satinato per artt.  
 Dish in satined glass for arts.  
 Coupelle en verre satiné pour arts.  
 Cubeta di vetro satinato para artt.

A18140 - A1814B

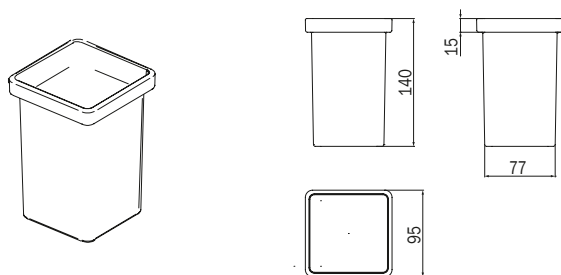

cod.	pz.	€
<b>R1814N</b>	1	36,00

**R76140** Bacinella in vetro satinato per artt.  
 Dish in satined glass for arts.  
 Coupelle en verre satiné pour arts.  
 Cubeta di vetro satinato para artt.

A36140 - A30140

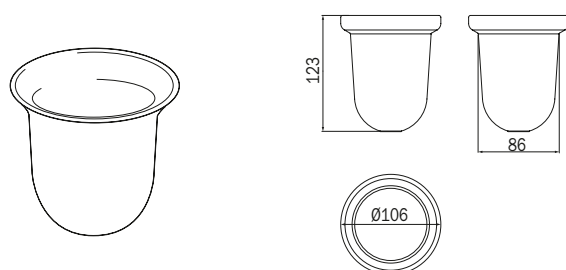

cod.	pz.	€
<b>R76140</b>	1	23,20

## RICAMBI / SPARE PARTS / PIÉCES DE RECHARGE / REPUESTOS

**R38140018** Bacinella in polipropilene (PP) neutro per artt.  
Dish in neutral polypropylene (PP) for arts.  
Coupelle en polypropylène (PP) neutre pour arts.  
Cubeta de polipropileno (PP) neutro para art.

A3814A - A32240 - A23240

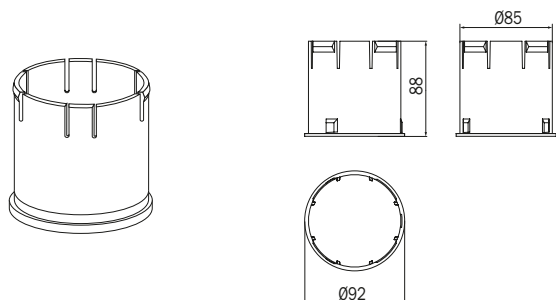

cod.	pz.	€
<b>R38140018</b>	1	4,60

**R31140004** Bacinella interna in polipropilene (PP) bianco per artt.  
Internal dish in white polypropylene (PP) for arts.  
Coupelle intérieur en polypropylène (PP) blanc pour arts.  
Cubeta interior de polipropileno (PP) blanco para art.

A04140 - AV086E - AV086D

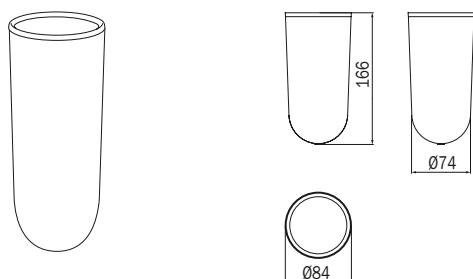

cod.	pz.	€
<b>R31140004</b>	1	4,90

**R31140003** Bacinella esterna in ABS cromato per artt.  
External dish in chrome-plated ABS for arts.  
Coupelle extérieur en ABS chromé pour arts.  
Cubeta exterior de ABS cromado para art.

A04140 - AV086E - AV086D

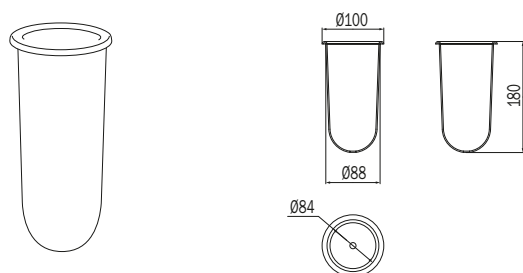

cod.	pz.	€
<b>R31140003</b>	1	34,90

**R05140** Bacinella in polipropilene (PP) bianco per artt.  
Dish in white polypropylene (PP) for arts.  
Coupelle intérieur en polypropylène (PP) blanc pour arts.  
Cubeta interior de polipropileno (PP) blanco para art.

A05140 - A0414A

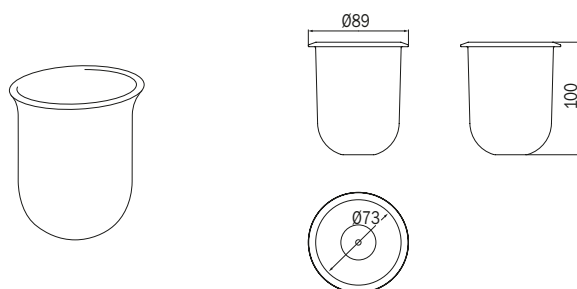

cod.	pz.	€
<b>R05140</b>	1	8,70

**R14680**

Ripiano in cristallo trasparente temperato 6 mm per art.  
Shelf in tempered transparent crystal mm 6 for art.  
Tablette en verre trempé transparent 6 mm pour art.  
Estante de cristal templado transparente 6 mm para art.

A46080

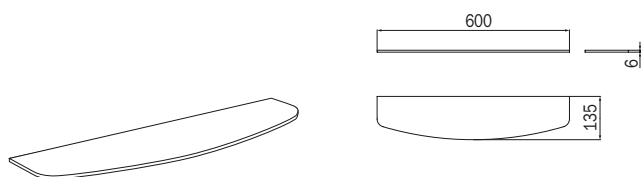

cod.	pz.	€
<b>R14680</b>	1	102,90

**R1150A**

Ripiano in cristallo trasparente temperato. Spessore vetro 6 mm  
Shelf in transparent tempered crystal.6 mm thick glass  
Tablette en verre trempé, épaisseur verre 6 mm.  
Estante de cristal templado, espesor vidrio 6 mm.

RV408A - R1809N

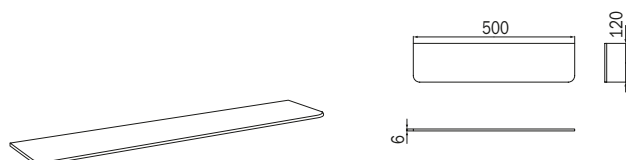

cod.	pz.	€
<b>R1150A</b>	1	43,60

**R76090**

Ripiano in cristallo temperato satinato 6 mm per art.  
Shelf in tempered satinated crystal mm 6 for art.  
Tablette en verre satiné trempé 6 mm pour art.  
Estante de cristal satinado templado 6 mm para art.

A36090

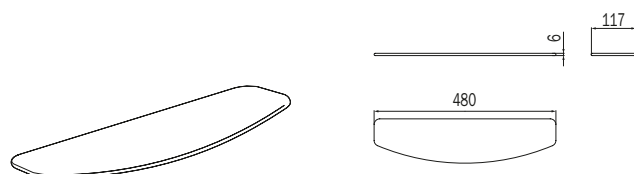

cod.	pz.	€
<b>R76090</b>	1	29,10

**R11320001**

Ripiano in cristallo satinato temperato 5 mm per art.  
Shelf in tempered satinated crystal mm 5 for art.  
Tablette en verre satiné trempé 5 mm pour art.  
Estante de cristal satinado templado 5 mm para art.

A32080

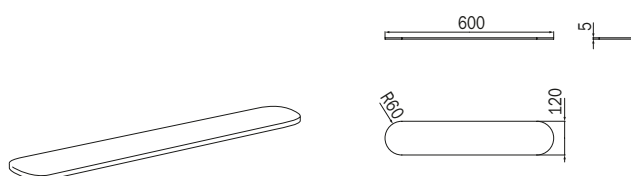

cod.	pz.	€
<b>R11320001</b>	1	68,30

## RICAMBI / SPARE PARTS / PIÉCES DE RECHARGE / REPUESTOS

**R11700002** Ripiano in cristallo trasparente temperato 6 mm per art.  
Shelf in tempered transparent crystal mm 6 for art.  
Tablette en verre trempé transparent 6 mm pour art.  
Estante de cristal templado transparente 6 mm para art.

A23070

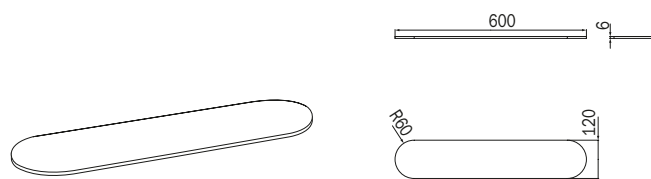

cod.	pz.	€
<b>R11700002</b>	1	53,00

**R11260** Ripiano in cristallo trasparente temperato 5 mm per art.  
Shelf in tempered transparent crystal mm 5 for art.  
Tablette en verre trempé transparent 5 mm pour art.  
Estante de cristal templado transparente 5 mm para art.

A2308A

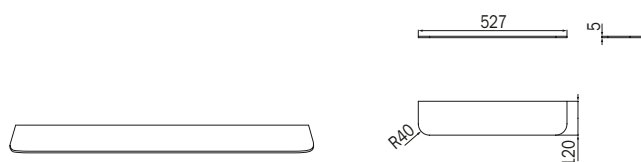

cod.	pz.	€
<b>R11260</b>	1	42,40

**R11260001** Ripiano in cristallo trasparente temperato 5 mm per art.  
Shelf in tempered transparent crystal mm 5 for art.  
Tablette en verre trempé transparent 5 mm pour art.  
Estante de cristal templado transparente 5 mm para art.

A2308C

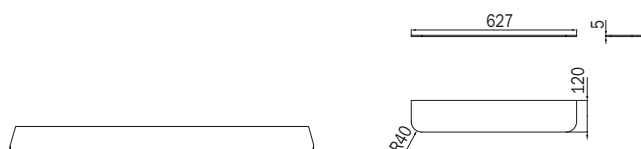

cod.	pz.	€
<b>R11260001</b>	1	47,40

**RV408A**

Supporti in ottone cromato, spessore vetro max 6 mm  
Supports in chrome-plated brass, the packing contains 2 pieces, max 6 mm thick glass  
Supports en laiton, vendus par deux, épaisseur verre max 6 mm  
Soportes de latón, paquetes de 2 unidades, espesor vidrio máx 6 mm

AV408A - AV408C

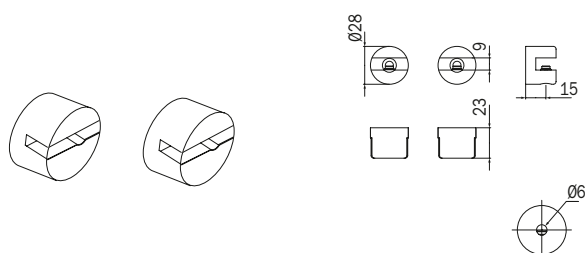

cod.	pz.	€
<b>RV408A</b>	1	36,60

**RV408A001** Ripiano in cristallo trasparente temperato 6 mm per art.  
Shelf in tempered transparent crystal mm 6 for art.  
Tablette en verre trempé transparent 6 mm pour art.  
Estante de cristal templado transparente 6 mm para art.

AV408A

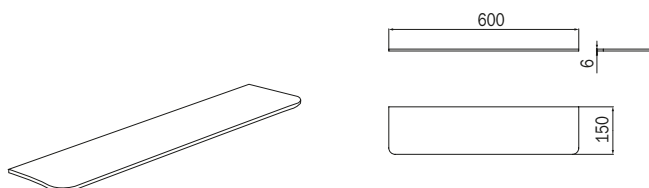

cod.	pz.	€
<b>RV408A001</b>	1	66,20

**R04310** Ripiano in PMMA trasparente per art.  
Shelf in transparent PMMA for art.  
Tablette en PMMA transparent pour art.  
Estante de PMMA transparente para art.

A04320

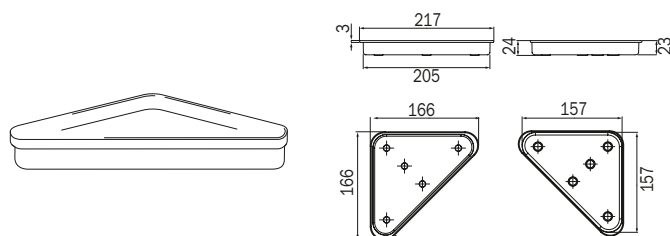

cod.	pz.	€
<b>R04310</b>	1	9,00

**R05300** Bacinella in vetro trasparente extrachiaro per art.  
Dish in extra clear transparent glass for art.  
Coupelle en verre transparent extra clair pour art.  
Cubeta de vidrio extraclaro transparente para art.

A05300

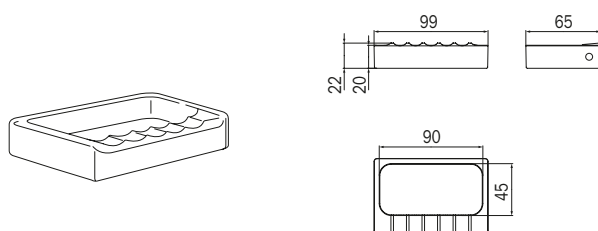

cod.	pz.	€
<b>R05300</b>	1	40,00

**R01500** Gancio per tende, in polipropilene (PP) bianco  
Curtain hook, in white polypropylene (PP)  
Crochet pour rideaux, en polypropylène (PP) blanc  
Gancho para cortinas, de polipropileno (PP) blanco

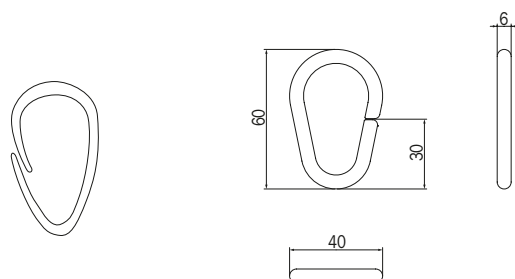

cod.	pz.	€
<b>R01500</b>	1	2,10

## RICAMBI / SPARE PARTS / PIÈCES DE RECHARGE / REPUESTOS

**R01500002** Confezione da 12 ganci per tende in polipropilene (PP) bianco  
 The packing contains 12 curtain hooks in white polypropylene (PP)  
 Lot de 12 crochets pour rideaux en polypropylène (PP) blanc  
 Paquete de 12 ganchos para cortinas de polipropileno (PP) blanco

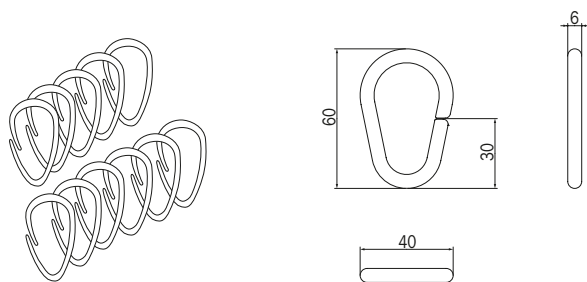

cod.	pz.	€
<b>R01500002</b>	1	3,90

### RV454A

Tubo per artt.  
 Flexible tube for arts.  
 Tube pour arts.  
 Tubo para art.

AV454C - AV454D

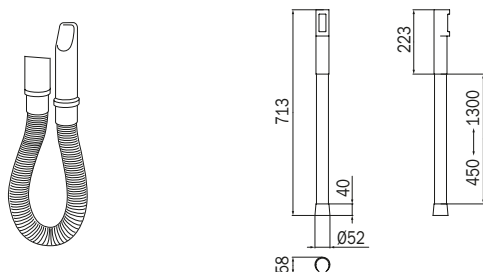

cod.	pz.	€
<b>RV454A</b>	1	86,70

### RMC128

N° 10 confezioni di 2 viti in inox mm Ø 4,2 L 38 + 2 tasselli  
 N° 10 packing with 2 screws in stainless steel mm Ø 4,2 L 38 + 2 dowels for arts.  
 N° 10 lots de 2 vis en inox mm Ø 4,2 L 38 + 2 chevilles  
 N° 10 bolsas con 2 tornillos de inox mm Ø 4,2 L 38 + 2 tacos

AV114A - AV014 - AV120 - AV190 - A2416A/  
 250/280/10A/110/120/15A/15B -  
 A4618/200/252/510/080/31V/150 -  
 A1520A/150 - A3814A - A3018A/B/C/D/E/19C/  
 15A/150/160/20A/20B/110/100/120/  
 10D/250/260/140/950/920/090 - A18090 -  
 A36090A/B/C - A2018A/B/C/D/150/160/20A/  
 20B/110/120/100/11Z/12Z/10Z/10N/25A/25B/  
 28A/260 - A38210/250 - AV401D/427G/567A -  
 A0467N/620/610/31V - AV0420/A - AV408A -  
 AV425A/B - A0525C - A07250 - A05620 - A06770 -  
 A5896 - AL483



cod.	pz.	€
<b>RMC128</b>	1	20,30

### RMC016

Viti in inox mm Ø 4,5 L 40 + 2 tasselli per artt.  
 Screws in stainless steel mm Ø 4,5 L 40 + 2 dowels for arts.  
 Vis en inox mm Ø 4,5 L 40 + 2 chevilles pour arts.  
 Tornillos de inox mm Ø 4,5 L 40 + 2 tacos para art.

A1351A - A1331A - A1051B - A1031B - AV426F -  
 AV426E - AV426D



cod.	pz.	€
<b>RMC016</b>	1	2,30

**RMC116**

N° 10 confezioni di 2 viti in inox mm Ø 4,5 L 40 + 2 tasselli per artt.  
 N° 10 packing with 2 screws in stainless steel mm Ø 4,5 L 40 + 2 dowels for arts.  
 N° 10 lots de 2 vis en inox mm Ø 4,5 L 40 + 2 chevilles pour arts.  
 N° 10 bolsas con 2 tornillos de inox mm Ø 4,5 L 40 + 2 tacos para art.

A1351A - A1331A - A1051B - A1031B - AV426F -  
 AV426E - AV426D



cod.	pz.	€
<b>RMC116</b>	1	22,00

**RMC028**

Vite in inox mm Ø 4,2 L 38 + tasselli, confezione da 2 pz. Per artt.  
 Screw in stainless steel mm Ø 4,2 L 38 + dowels, the packing contains 2 pcs. for Arts.  
 Vis en inox mm Ø 4,2 L 38 + chevilles, lot de 2 pz. pour arts.  
 Tornillo de inox mm Ø 4,2 L 38 + tacos, paquete de 2 piezas para art.

AV114A - AV014 - AV120 - AV190 - A2416A/  
 250/280/10A/110/120/15A/15B -  
 A4618/200/252/510/080/31V/150 - A1520A/150  
 - A3814A - A38210/250 - AV401D/427G/567A  
 - A0467N/620/610/31V - AV0420/A - AV408A -  
 AV425A/B - A0525C - A07250 - A05620 - A06770  
 - A5896 - AL483



cod.	pz.	€
<b>RMC028</b>	1	2,10

**RMC029**

Vite in inox mm Ø 5,5 L 50 + tasselli, confezione da 2 pz. Per artt.  
 Screw in stainless steel mm Ø 5,5 L 50 + dowels, the packing contains 2 pcs. For Arts.  
 Vis en inox mm Ø 5,5 L 50 + chevilles, lot de 2 pz. pour arts.  
 Tornillo de inox mm Ø 5,5 L 50 + tacos, paquete de 2 piezas para art.

A1510N - A1518 - A1525A



cod.	pz.	€
<b>RMC029</b>	1	2,00

**RMC025**

Vite in inox mm Ø 4,2 L 38 + tasselli, confezione da 2 pz. per artt.  
 Screw in stainless steel mm Ø 4,2 L 38 + dowels, the packing contains 2 pcs. for arts.  
 Vis en inox mm Ø 4,2 L 38 + chevilles, lot de 2 pz. pour arts.  
 Tornillo de inox mm Ø 4,2 L 38 + tacos, paquete de 2 piezas para art.

A3827A - A0591M - A12252 - A12253 - A05300  
 - A04490 - A04510 - A04500 - A04320 - A04310 -  
 A04030 - A05430 - A04660 - AV401A - AV427A



cod.	pz.	€
<b>RMC025</b>	1	1,60

## RICAMBI / SPARE PARTS / PIÈCES DE RECHARGE / REPUESTOS

### RMC062

Vite in inox mm Ø 5,5 L 50 + tasselli, confezione da 6 pz. per artt.  
Screw in stainless steel mm Ø 5,5 L 50 + dowels, the packing contains 6 pcs. for arts.  
Vis en inox mm Ø 5,5 L 50 + chevilles, lot de 6 pz. pour arts.  
Tornillo de inox mm Ø 5,5 L 50 + tacos, paquete de 6 piezas para art.

A36920 - A36950 - A0492T - A0491T - A0490T  
- A0490F - A0490C - A04690 - A0148A -  
A01400CR003 - A048E/G/M - A30920 - A30950

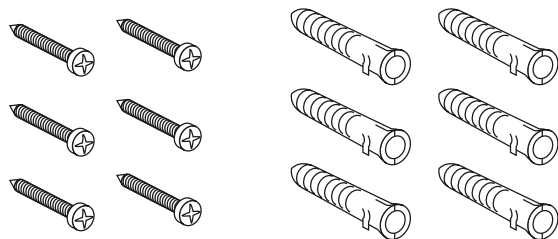

cod.	pz.	€
RMC062	1	6,60

### R1300001

Coprivite per artt.  
Screw covers for arts.  
Cache-vis pour arts.  
Cubre tornillos para art.

A1331A - A1351A - AV426F - AV426D - AV426E

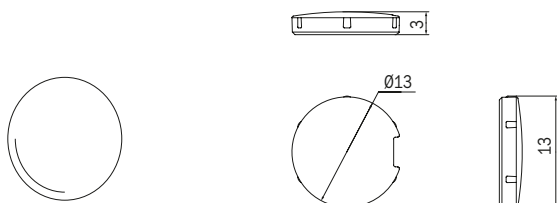

cod.	pz.	€
R1300001	1	2,00

### RMC031

Vite in inox mm Ø 4,2 L 38 + tasselli, confezione da 3 pz. per artt.  
Screw in stainless steel mm Ø 4,2 L 38 + dowels, the packing contains 3 pcs. for arts.  
Vis en inox mm Ø 4,2 L 38 + chevilles, lot de 3 pz. pour arts.  
Tornillo de inox mm Ø 4,2 L 38 + tacos, paquete de 3 piezas para art.

A2490A/B/C/D/91C/680/260 - A2390A/B/C/  
D/91B/C/16T/150/110/100/210/67A/490/510/  
280/270/250/08A/08C - AV4280 - A04210/200/94  
/18/160/10N/100/110/11A/140/680 - A0458A/C  
- AV058C/D - A0144 - A01410 - A2301N/070 -  
A0414A - A0468C

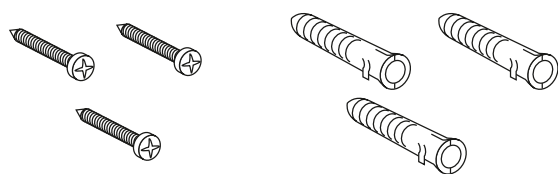

cod.	pz.	€
RMC031	1	3,10

### R8035A

Anta per artt.  
Door for arts.  
Porte pour arts.  
Puerta para art.

A8035A/B - A8036A/B - A8037A/B - A8038A/B

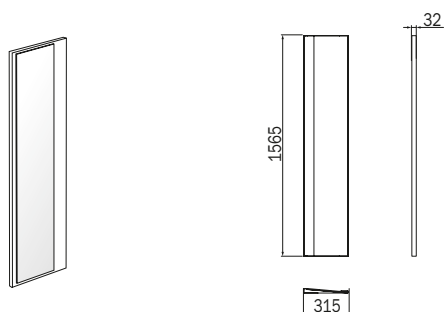

cod.	pz.	€
R8035A	1	436,00

(BX)



**R8035A**

Anta per artt.  
Door for arts.  
Porte pour arts.  
Puerta para art.

A8035A/B - A8036A/B - A8037A/B - A8038A/B

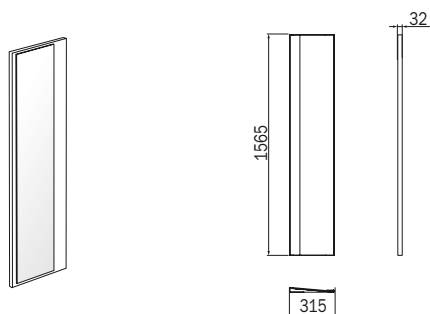

001 (CE)  
002 (NX)  
003 (CX)  
004 (AX)  
005 (MP)  
006 (TL)  
007 (BN)  
008 (AQ)  
009 (GD)

cod.	pz.	€
<b>R8035A ...</b>	1	436,00

**R80750**

Anta per artt.  
Door for arts.  
Porte pour arts.  
Puerta para art.

A80750 - A80760

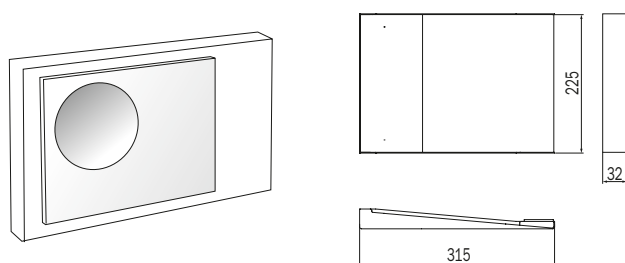

(BX)

cod.	pz.	€
<b>R80750</b>	1	183,30

**R80750**

Anta per artt.  
Door for arts.  
Porte pour arts.  
Puerta para art.

A80750 - A80760

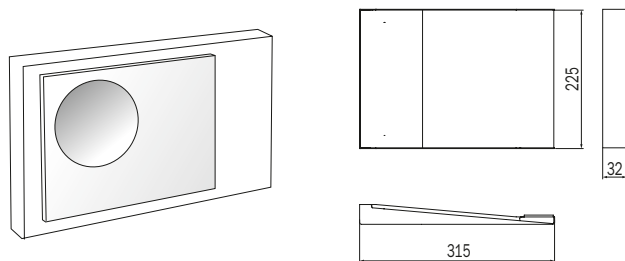

001 (CE)  
002 (NX)  
003 (CX)  
004 (AX)  
005 (MP)  
006 (TL)  
007 (BN)  
008 (AQ)  
009 (GD)

cod.	pz.	€
<b>R80750 ...</b>	1	183,30

**R8085A**

Anta portarotolo per artt.  
Paper holder door for arts.  
Porte porte-rouleau pour arts.  
Puerta portarollos para art.

A8085A/B - A8086A

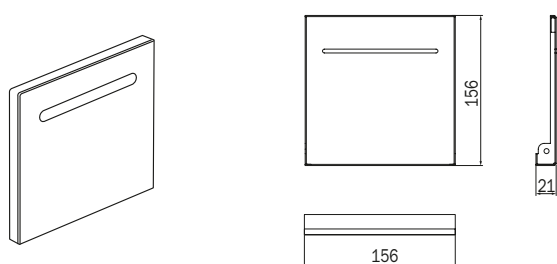

(BX)

cod.	pz.	€
<b>R8085A</b>	1	48,90

# RICAMBI / SPARE PARTS / PIÉCES DE RECHARGE / REPUESTOS

## R8085A

Anta portarotolo per artt.  
Paper holder door for arts.  
Porte porte-rouleau pour arts.  
Puerta portarollos para art.

A8085A/B - A8086A

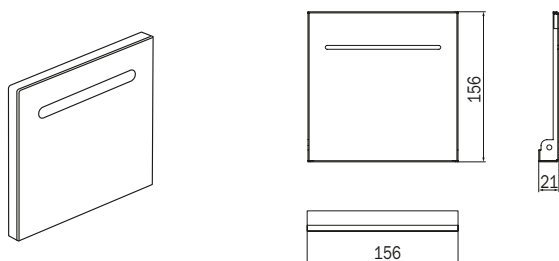

001 (CE)  
002 (NX)  
003 (CX)  
004 (AX)  
005 (MP)  
006 (TL)  
007 (BN)  
008 (AQ)  
009 (GD)

cod.	pz.	€
R8085A ...	1	48,90

## R8085A

Anta portascopino My Love per artt.  
Toilet brush My Love holder door for arts.  
Porte porte-balai My Love pour arts.  
Puerta escobillero My Love para art.

A8085A/C - A8086A/C

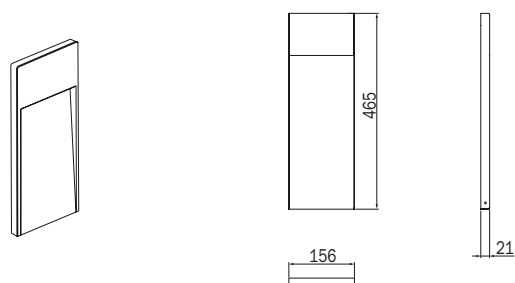

010 (BX)  
011 (CE)  
012 (NX)  
013 (CX)  
014 (AX)  
015 (MP)  
016 (TL)  
017 (BN)  
018 (AQ)  
019 (GD)

cod.	pz.	€
R8085A ...	1	129,70

## R8085B

Anta idroscopino per artt.  
Hydrobrush door for arts.  
Porte douchette hygiénique WC pour arts.  
Puerta ducha higiénica para art.

A8085B/D

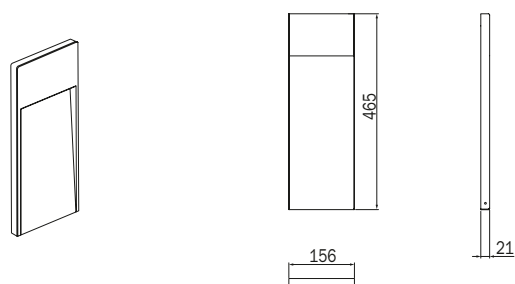

(BX)

cod.	pz.	€
R8085B	1	129,70

## R8085B

Anta idroscopino per artt.  
Hydrobrush door for arts.  
Porte douchette hygiénique WC pour arts.  
Puerta ducha higiénica para art.

A8085B/D

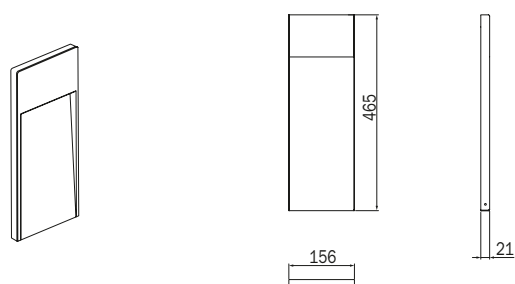

001 (CE)  
002 (NX)  
003 (CX)  
004 (AX)  
005 (MP)  
006 (TL)  
007 (BN)  
008 (AQ)  
009 (GD)

cod.	pz.	€
R8085B ...	1	129,70

**R8085B010** Idroscopino per artt.  
Hydrobrush for arts.  
Douchette hygiénique WC pour arts.  
Ducha higiénica para art.

A8085B/D

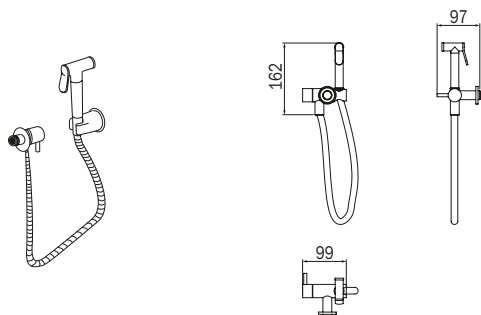

cod.	pz.	€
<b>R8085B010</b>	1	164,00

**R8085C** Anta portarotolo per artt.  
Paper holder door for arts.  
Porte porte-rouleau pour arts.  
Puerta portarollos para art.

A8085C/D

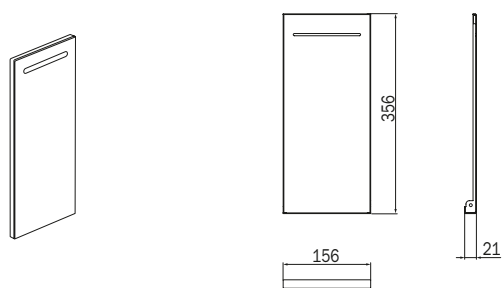

cod.	pz.	€
<b>R8085C</b>	1	77,20

**R8085C** Anta portarotolo per artt.  
Paper holder door for arts.  
Porte porte-rouleau pour arts.  
Puerta portarollos para art.

A8085C/D

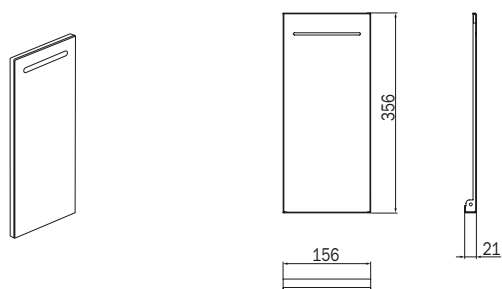

cod.	pz.	€
<b>R8085C ...</b>	1	77,20

001 (CE)  
002 (NX)  
003 (CX)  
004 (AX)  
005 (MP)  
006 (TL)  
007 (BN)  
008 (AQ)  
009 (GD)

**RMOB7750221** Mensola in vetro per artt.  
Glass shelf for arts.  
Tablette en verre pour arts.  
Repisa de vidrio para art.

A8035A/B/C - A8036A/B/C - A8037A/B/C - A8038A/B

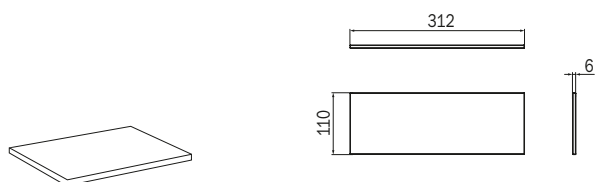

cod.	pz.	€
<b>RMOB7750221</b>	1	18,60

CERTIFICATO  
 CERTIFICADO  
 CERTIFIKAT  
 証明書  
 CERTIFICATE  
 ZERTIFIKAT



# CERTIFICATO

Nr. 50 100 3476 Rev.010

STATISTISKE / STATISTISKE / STATISTISKE

IL SISTEMA DI GESTIONE PER LA QUALITÀ DI  
THE QUALITY MANAGEMENT SYSTEM OF

**INDA S.p.A.**

SEDE LEGALE E OPERATIVA:  
REGISTERED OFFICE AND OPERATIONAL SITE:

**VIA DELL'INDUSTRIA 41**  
**IT - 24040 PAGAZZANO (BG)**

SEDE OPERATIVA:  
OPERATIONAL SITE:



**VIA POSTUMIA OVEST 72**  
**IT - 31048 SAN BIAGIO DI CALLALTA (TV)**

È CONFORME AI REQUISITI DELLA NORMA  
HAS BEEN FOUND TO COMPLY WITH THE REQUIREMENTS OF

**UNI EN ISO 9001:2015**

QUESTO CERTIFICATO È VALIDO PER IL SEGUENTE CAMPO DI APPLICAZIONE  
THIS CERTIFICATE IS VALID FOR THE FOLLOWING SCOPE OF APPLICATION

**Progettazione e fabbricazione di accessori e mobili per l'arredo del bagno (par 17, 23)**  
*Design and manufacture of accessories and furniture solutions for bathroom décor (par 17, 23)*

Per l'Organismo di Certificazione For the Certification Body TUV Italia S.p.A.	Validità / Validity
	Dal / From: 2021-11-21
SGQ N° 018A	Al / To: 2024-11-20
<p style="font-size: x-small;">SEDE LEGALE E OPERATIVA REGISTERED OFFICE AND OPERATIONAL SITE</p> <p style="font-size: x-small;">SEDE OPERATIVA OPERATIONAL SITE</p>	Data emissione / Issuing Date
 <b>Francesco Sorrelia</b> <small>Responsabile Ufficio Tecnico Technical Assistant (Quality Manager)</small>	2021-11-04























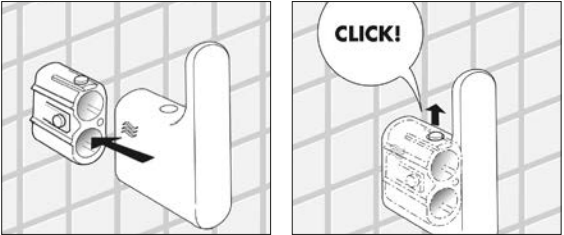





**PRIMA CERTIFICAZIONE / FIRST CERTIFICATION: 2003-11-27**

LA VALIDITÀ DEL PRESENTE CERTIFICATO È SUBORDINATA A SUCCESSIVE VERIFICHE A 12 MESI E AL PRIMO SCADUTO DEL CERTIFICATO  
THE VALIDITY OF THE PRESENT CERTIFICATE IS SUBORDINATED TO THE PERIODIC CHECKS TO BE MADE AT 12 MONTHS AND ON THE COMPLETION OF THE CHECKS  
CERTIFICATE VALIDITY EXTENDS FOR THREE YEARS

TUV Italia • Gruppo TÜV SÜD • Via Caraccioli 126, Par. 23 • 20099 Sesto San Giovanni (MI) • Italia • [www.tuv.it](http://www.tuv.it) • TÜV®

- La divisione Inda accessori ha ottenuto da TÜV Italia - Gruppo TÜV Sud la certificazione del sistema di qualità, in accordo alla normativa UNI EN ISO 9001:2015.
- La globalità dei processi operativi, dall'acquisizione dell'ordine alla consegna del prodotto, è costantemente sotto controllo.
- TÜV Italia, garantisce la conformità di Inda agli elevati standard qualitativi imposti dalla certificazione UNI EN ISO 9001:2015. Questo risultato garantisce la costante affidabilità dell'intero sistema aziendale.
- The Inda accessories division has obtained the quality system certification from TÜV Italia - Gruppo TÜV Sud, according to the UNI EN ISO 9001:2015 standard.
- Overall operative processes, from order purchase to product delivery, are constantly checked.
- TÜV Italy guarantees the Inda conformity with higher quality standards provided by the UNI EN ISO 9001:2015 certification. This result ensures complete and constant company system dependability.
- La divisione accessoires INDA a obtenu de TÜV Italia - Gruppo TÜV Sud la certification de leur système de qualité, selon la norme UNI EN ISO 9001:2015.
- La globalité des procédés d'exploitation, de l'enregistrement de la commande à la livraison du produit est constamment sous contrôle.
- TÜV Italia garantit la conformité de Inda aux standards de qualité élevés qu'impose la certification UNI EN ISO 9001:2015. Ce résultat garantit la fiabilité constante de toute l'organisation de l'entreprise.
- La División accesorios Inda ha obtenido la certificación TÜV Italia - Gruppo TÜV Sud del sistema de calidad, conforme a la normativa UNI EN ISO 9001:2015.
- La totalidad de los procesos operativos, desde que se reciben los pedidos hasta la entrega del producto, está constantemente bajo control.
- TÜV Italia, garantiza la conformidad de Inda a los elevados estándares de calidad impuestos por la certificación UNI EN ISO 9001:2015. Este resultado garantiza la constante fiabilidad del sistema empresarial completo.

**TECNICHE**  
**TECHNICAL**  
**TECHNIQUES**  
**TÉCNICAS**

	<b>Installazione reversibile</b> Reversible installation Installation réversible Instalación reversible		<b>Installazione non reversibile</b> Not reversible installation Installation non réversible Instalación no reversible
	<b>Articolo con chiave</b> Article with key Article avec clé Artículo con llave		<b>Prodotto ignifugo</b> Fireproof product Produit ignifuge Artículo inñfugo
	<b>Fattore di ingrandimento</b> Magnifying factor Facteur de grossissement Factor de aumento		<b>Silenzioso</b> Silent Silencieux No ruido
	<b>Tagliabile a misura</b> Feasible to be cut at required measure Coupés à votre dimension Se puede cortar a medida		<b>Articoli sganciabili</b> Removable products Articles amovibles Artículos desenganchables
	<b>Bacinella con foro</b> Dish with hole Coupelle percée Bandeja con orificio		<b>Fissaggio con tasselli</b> Fixing with plugs Fixation avec chevilles Fijación con clavijas
	<b>Possibile installazione a muro mediante adesivo in pasta</b> Possible wall-mounted installation with paste adhesive Installation murale possible grâce à la colle prévue à cet effet Posible instalación a pared mediante adhesivo en pasta		<b>Kit fissaggio a parete</b> Fixing kit with glue Kit de fixation avec colle Kit de fijación con pasta
			<b>Chiusura rallentata</b> Soft closing Fermeture ralentie Cierre ralentizado
	<b>Iluminazione a led</b> Led lighting Eclairage à led Iluminación led		<b>Capacità di contenimento</b> Containment capacity Capacité Capacidad
	<b>Temperatura del colore della luce (tonalità)</b> Color temperature Température de couleur Color de la temperatura (Tonalidad)		<b>Regolazione dell'intensità della luce</b> Light intensity adjustment Réglage de l'intensité lumineuse Ajuste de la intensidad de la luz
	<b>Regolazione del colore della luce</b> Light color adjustment Réglage de couleur Ajuste del color de la luz		<b>Antibatterico</b> Antibacterial Antibactérien Antibacteriano
	<b>Ricaricabile</b> Rechargeable Interchangeable Recargable		<b>Sistema autocentrante</b> Self-centering-system Système d'auto-centrage Sistema autocentrante
	<b>Resistenza meccanica</b> Mechanical resistance Résistance mécanique Resistencia mecánica		<b>Portasalviette carta da 350 pezzi</b> Paper towel dispenser for 350 pcs Distributeur de serviettes pour 350 pièces Portaservilletas de papel para 350 piezas
	<b>Nuovi articoli / serie</b> New articles / series Nouveaux articles / séries Nuevos artículos / serie		<b>Disponibile da</b> Available starting from Disponible à partir de Disponible del
	<b>Articoli in eliminazione</b> Product to be discontinued Articles en élimination Artículos en eliminación		<b>4 ore di posa</b> 4 hours of laying 4 heures de pose 4 horas de colocación

## Legenda simboli / Symbol key Légende symboles / Leyenda símbolos

<b>ELETRICHE</b>	<b>(Phon, asciugamani, ecc.)</b>
<b>ELECTRICAL</b>	<b>(Hairdryers, hand dryers, etc.)</b>
<b>ELECTRIQUES</b>	<b>(Sèche-cheveux, sèche-mains, etc.)</b>
<b>ELÉTRICOS</b>	<b>(Secadores de manos, etc.)</b>



### Grado di protezione IP

La "resistenza" offerta dall'apparecchio alla penetrazione di solidi e liquidi viene indicata dal prefisso IP (International Protection) seguita da 2 cifre significative, di cui la prima identifica il grado di protezione contro l'ingresso dei corpi solidi e la seconda dei liquidi.

Prima cifra caratteristica (solidi)

**X** non rilevante

**0** non protetto

**1** protetto contro la penetrazione di corpi solidi di dimensioni superiori a 50 mm.

**2** protetto contro la penetrazione di corpi solidi di dimensioni superiori a 12 mm.

**3** protetto contro la penetrazione di corpi solidi di dimensioni superiori a 2,5 mm.

**4** protetto contro la penetrazione di corpi solidi di dimensioni superiori a 1 mm.

Seconda cifra caratteristica (liquidi)

**0** non protetto

**1** protetto contro le cadute verticali di gocce d'acqua

**2** protetto contro la caduta dell'acqua con inclinazione massima di 15°

**3** protetto contro la pioggia

**4** protetto contro gli spruzzi

### IP protection level

The appliance "resistance" to solids and liquids penetration, is indicated by the IP (International Protection) code followed by two significant numbers, the first identifies the protection level against solid parts entering and the second against liquids.

First characteristic number (solids)

**X** not relevant

**0** not protected

**1** protected against penetration of solid parts exceeding 50 mm from penetrating.

**2** protected against penetration of solid parts exceeding 12 mm from penetrating.

**3** protected against penetration of solid parts exceeding 2,5 mm from penetrating.

**4** protected against penetration of solid parts exceeding 1 mm from penetrating.

Second characteristic number (liquids)

**0** not protected

**1** not protected against water falling at a maximum inclination of 15°

**2** protected against water falling at a maximum inclination of 15°

**3** protected against rain

**4** protected against spraying

### Degré de protection IP

La "résistance" offerte par l'appareil contre la pénétration de solides et de liquides est indiquée par le préfixe IP (international protection) suivi de 2 chiffres significatifs: le premier indique le degré de protection contre l'entrée de corps solides et le second contre celle de liquides.

Premier chiffre caractéristique (solides)

**X** insignifiant

**0** pas protégé

**1** protégé contre la pénétration de corps solides de dimensions supérieures à 50 mm.

**2** protégé contre la pénétration de corps solides de dimensions supérieures à 12 mm.

**3** protégé contre la pénétration de corps solides de dimensions supérieures à 2,5 mm.

**4** protégé contre la pénétration de corps solides de dimensions supérieures à 1 mm.

Second chiffre caractéristique (liquides)

**0** pas protégé

**1** protégé contre les tombées verticales de gouttes d'eau

**2** protégé contre les tombées d'eau avec inclinaison maximum de 15°

**3** protégé contre la pluie

**4** protégé contre les éclaboussures

### Grado de protección IP

La "resistencia" que el aparato ofrece a la entrada de sólidos y líquidos se indica con el prefijo IP (International Protection) seguida de 2 cifras indicativas, de las cuales, la primera identifica el grado de protección frente a la entrada de cuerpos sólidos y la segunda frente a líquidos.

Primera cifra indicativa (sólidos)

**X** no relevante

**0** no protegido

**1** protegido frente a la entrada de cuerpos sólidos de dimensiones superiores a 50 mm.

**2** protegido frente a la entrada de cuerpos sólidos de dimensiones superiores a 12 mm.

**3** protegido frente a la entrada de cuerpos sólidos de dimensiones superiores a 2,5 mm.

**4** protegido frente a la entrada de cuerpos sólidos de dimensiones superiores a 1 mm.

Segunda cifra indicativa (líquidos)

**0** no protegido

**1** protegido frente a las caídas verticales de gotas de agua

**2** protegido frente a la caída del agua con inclinación máxima de 15°

**3** protegido frente a la lluvia

**4** protegido frente a las salpicaduras



La marcatura CE è significato di libera circolazione nel mercato europeo; è quindi il passaporto obbligatorio per le frontiere dell'Unione Europea.  
Tutti i nostri prodotti per illuminazione ed elettrici sono conformi alle **direttive**.

The CE mark means free circulation in the European market; it is, therefore, the mandatory passport for all European Union borders.  
All our electrical and lighting products conform to the **standards**.

Le label CE est synonyme de libre circulation à l'intérieur du marché européen; il représente, par conséquent, le passeport obligatoire pour les frontières de l'union européenne.  
Tous nos produits électriques et d'éclairage sont conformes aux **directives**:

La marca CE representa la libre circulación en el mercado europeo, y es por lo tanto el pasaporte obligatorio en las fronteras de la Unión Europea.  
Todos nuestros productos eléctricos y para la iluminación son conformes con las directivas:



**Marchio CLASSE II**  
**CLASS II mark**  
**Label CLASSE II**  
**Marca CLASSE II**

Con doppio isolamento e/o isolamento rinforzato in ogni parte e senza dispositivi per la messa a terra.

With double insulation and/or reinforced insulation on all parts and without e/o earthing devices.

Avec double isolation et/ou isolation renforcée pour chaque partie et sans dispositif de mise à la terre.

Con doble aislamiento y/o aislamiento reforzado en cada componente y sin dispositivos para conexión a tierra.



**Marchio SEV**  
**SEV mark**  
**Label SEV**  
**Marca SEV**

Istituto di certificazione svizzero sulla sicurezza degli apparati elettrici.

Swiss Quality Mark Institute for safe electrical appliances.

Institut de certification suisse pour la sécurité des appareils électriques.

Instituto de certificación suizo sobre la seguridad de los aparatos eléctricos.



**Presa elettrica**  
**Electrical plug**  
**Prise électrique**  
**Toma de corriente**



**No presa elettrica**  
**No electrical socket**  
**Pas de prise électrique**  
**Sin enchufe eléctrico**



**Marchio NEMKO**  
**NEMKO mark**  
**Label NEMKO**  
**Marca NEMKO**

**MECCANICHE** (maniglioni, sgabelli, ecc.)  
**MECHANICAL** (Grap-bars, stools, etc.)  
**MECANIQUES** (Barres d'appui, tabourets, etc.)  
**MECÁNICOS** (manillones, taburetes, etc.)



**Marchio TÜV**  
**TÜV mark**  
**Label TÜV**  
**Marca TÜV**

Certifica la resistenza meccanica sotto i carichi indicati.

It certifies the mechanical resistance to the indicated loads.

Certifie la résistance mécanique pour les charges indiquées.

Certifica la resistencia mecánica de las barras rectas sometidas a las cargas indicadas.



Fissaggio con tasselli  
 Fixing with plugs  
 Fixation avec chevilles  
 Fixing with plugs

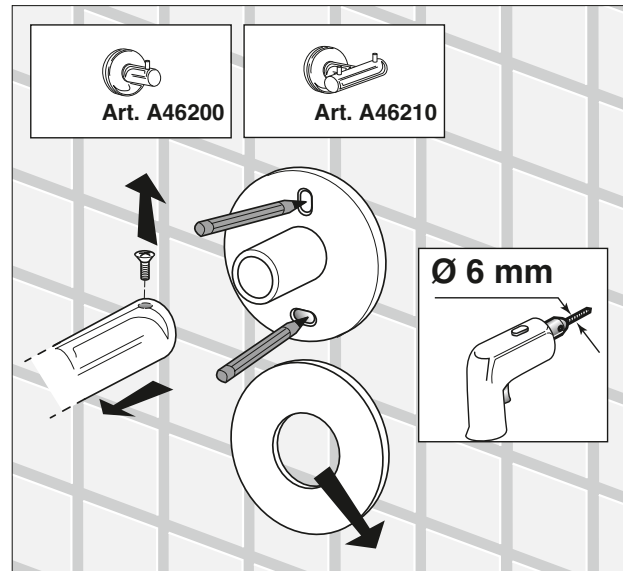
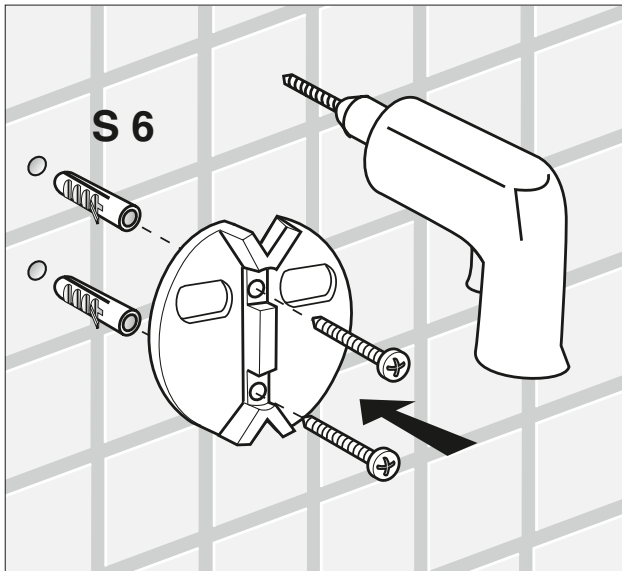

click

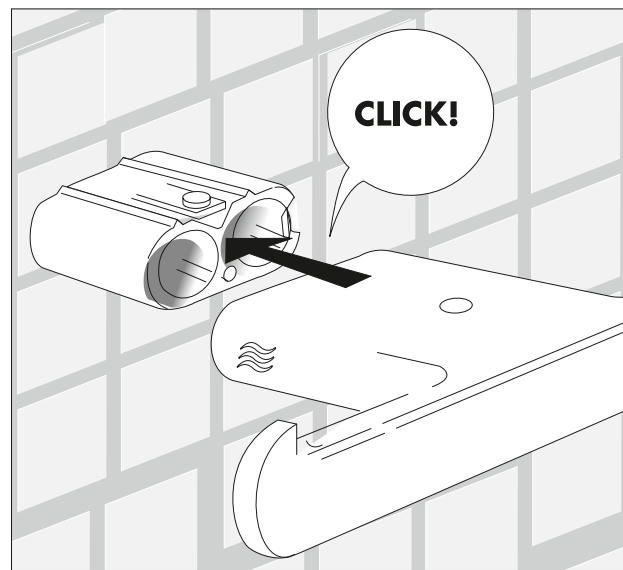
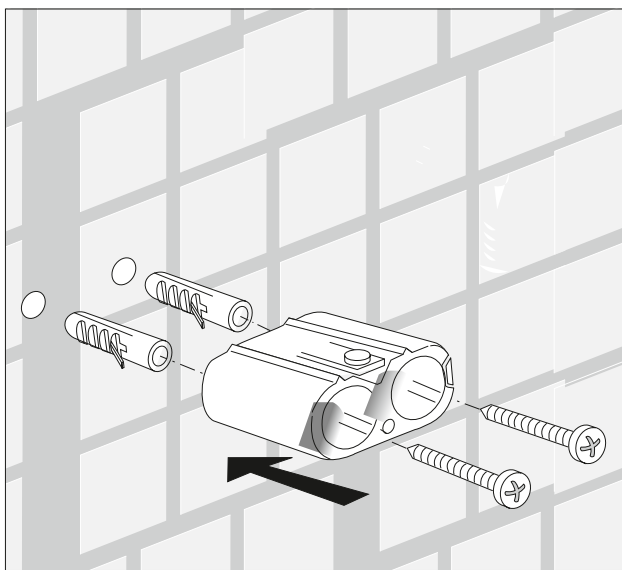





Possibile installazione a muro mediante adesivo in pasta  
 Possible wall-mounted installation with paste adhesive  
 Installation murale possible grâce à la colle prévue à cet effet  
 Posible instalación a pared mediante adhesivo en pasta

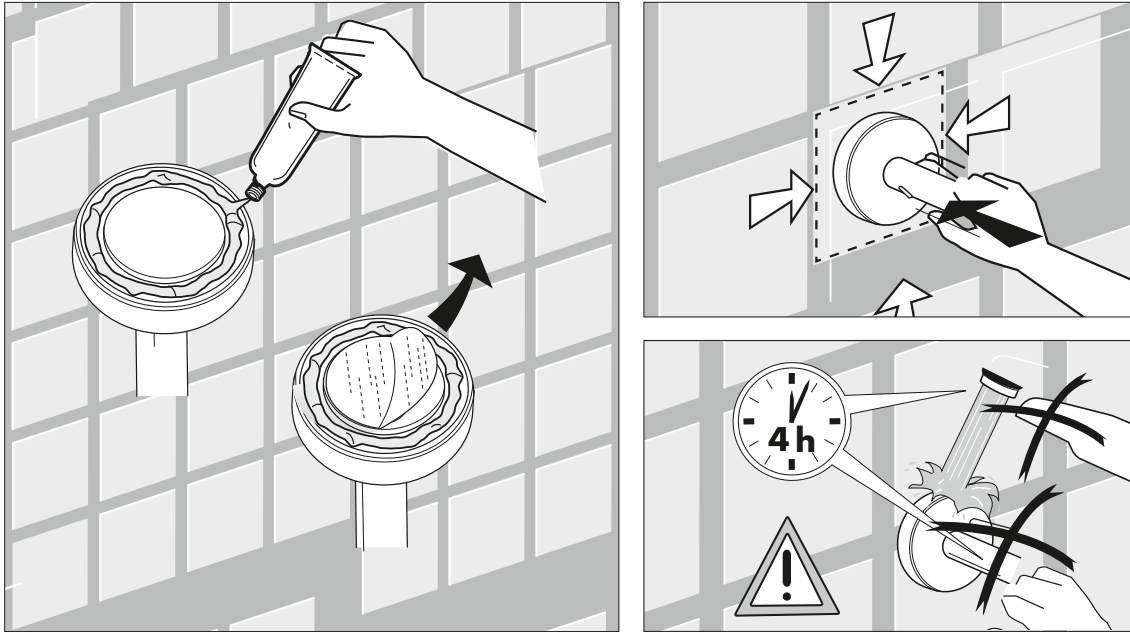

Kit fissaggio a parete  
 Fixing kit with glue  
 Kit de fixation avec colle  
 Kit de fijación con pasta

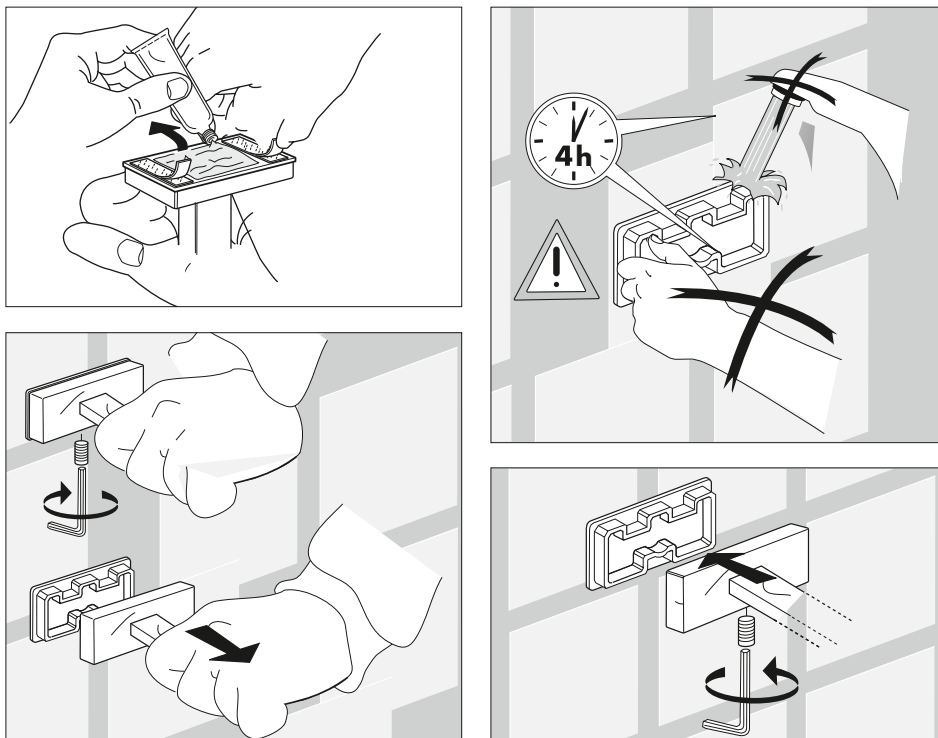



## PREZZI IVA ESCLUSA Le misure sono in mm.

1. VALIDITA' E DIRITTO DI MODIFICA
  - 1.1 Qualsiasi contratto sottoscritto da INDA SpA per la vendita dei propri prodotti indicati nel listino prezzi (di seguito i "Prodotti" e ciascuno di essi il "Prodotto") a qualunque cliente (di seguito l'"Acquirente") sarà soggetto alle presenti condizioni generali di vendita. In caso di discordanza tra quanto previsto dalle presenti condizioni generali di vendita e quanto pattuito in specifici accordi tra INDA SpA e l'Acquirente, prevarrà quanto previsto in detti specifici accordi.
  - 1.2 INDA SpA si riserva il diritto di modificare e/o variare le presenti condizioni generali di vendita nonché il listino prezzi.
2. CARATTERISTICHE DEI PRODOTTI
  - 2.1 Nei singoli contratti di vendita stipulati da INDA SpA, le eventuali informazioni riguardanti i Prodotti ed il loro uso sono vincolanti per le parti, salvo che le parti non abbiano previsto diversamente nel singolo contratto di vendita.
  - 2.2 Eventuali informazioni o dati sulle caratteristiche e/o specifiche tecniche dei Prodotti contenute nel listino prezzi sono indicative e non vincolanti. I Prodotti vengono realizzati con diversi materiali: INDA SpA si riserva il diritto di apportare ai Prodotti le modifiche che, senza alterarne le caratteristiche essenziali e di imballo, dovessero risultare necessarie e/o opportune.
3. PREZZO E TERMINI DI PAGAMENTO
  - 3.1 Ove non vi sia stato uno specifico accordo tra INDA SpA e l'Acquirente in merito al prezzo dei Prodotti, si applicherà per ciascun Prodotto il relativo prezzo di listino in vigore al momento della conclusione del contratto. I prezzi per la vendita dei Prodotti indicati nel listino prezzi si intendono franco Magazzino Centrale o franco Fabbrica, IVA e ogni altra tassa o imposta esclusa.
  - 3.2 Qualora l'Acquirente non effettui il pagamento di quanto dovuto entro il termine pattuito, INDA SpA potrà, a propria discrezione e senza alcun preavviso, sospendere le consegne in corso relativamente ai Prodotti non ancora consegnati e/o annullare le ulteriori consegne. A pagamento avvenuto, i tempi di spedizione degli ordini rimasti in sospeso saranno ricalcolati, a far data dal pagamento stesso, in base ai termini di produzione indicati nel listino prezzi. I pagamenti dei Prodotti già consegnati non saranno subordinati al completamento dell'ordine.
  - 3.3 Senza alcun pregiudizio per gli ulteriori rimedi consentiti dalla legge e dalle presenti condizioni generali di vendita, fatto salvo il diritto al risarcimento dei danni, INDA SpA si riserva il diritto di applicare tassi di mora su pagamenti ritardati a decorrere dalla data in cui sia maturato il diritto di pagamento, in attuazione dal Decreto Legislativo n°231/2002 e secondo gli aggiornamenti comunicati periodicamente dal Ministero dell'Economia e delle Finanze, senza necessità di formale costituzione in mora.
  - 3.4 INDA SpA ha diritto al risarcimento dei costi sostenuti per l'eventuale recupero delle somme non tempestivamente corrispostegli, come previsto dal Decreto Legislativo n°231 del 2002.
  - 3.5 Il prezzo pattuito, salvo ove diversamente indicato, rimane invariato fino alla data di spedizione indicata nella conferma d'ordine. Se, per richiesta dell'Acquirente o per motivi non imputabili a INDA SpA, la data di spedizione viene posticipata, INDA SpA si riserva di rivedere il prezzo applicando all'Acquirente eventuali aumenti e/o spese di sosta e magazzinaggio nel frattempo intervenuti.
4. ACCETTAZIONE DEGLI ORDINI
  - 4.1 Gli ordini verranno considerati validi solo se effettuati per iscritto e ricevuti da INDA SpA, via telefax o via e-mail, agli indirizzi dalla stessa comunicati.
  - 4.2 Nessun contratto sarà concluso tra INDA SpA e l'Acquirente fino a che non vi sia stata accettazione scritta dell'ordine dell'Acquirente da parte di INDA SpA, tramite conferma d'ordine giunta a conoscenza dell'Acquirente.
  - 4.3 Ordine e/o modifiche di ordini dovranno essere comunicati/confermati per iscritto dall'Acquirente tramite telefax o e-mail.
  - 4.4 Ordini di importo lordo inferiore ad Euro 300,00 (IVA esclusa) saranno gravati di un addebito di Euro 8,00 netti per spese forfettarie di gestione ordine.
  - 4.5 INDA SpA si riserva il diritto di valutare la fattibilità di Prodotti su specifica richiesta dell'Acquirente, di stabilirne i prezzi, le modalità e i termini di consegna.
5. GARANZIA DI CONFORMITA' PRODOTTI
  - 5.1 INDA SpA garantisce i propri prodotti per 24 mesi a decorrere dalla data d'acquisto e comunque entro i limiti del DPR 224 24/05/88 e secondo le direttive Europee. La garanzia copre esclusivamente vizi e difetti di fabbricazione o assemblaggio. Difetti estetici o strutturali devono essere comunicati per iscritto a INDA SpA solo ed esclusivamente prima dell'installazione, allegando i documenti di acquisto e di prodotto.
  - 5.2 La garanzia impegna INDA SpA solo alla riparazione e/o alla sostituzione degli elementi difettosi: sono pertanto escluse ulteriori pretese da parte dell'acquirente, ed esclude qualsiasi indennizzo derivato dal disagio, od onere o costo relativo accessorio. La non conformità dovrà essere riconosciuta solo da parte di personale autorizzato da INDA SpA
  - 5.3 Sono comunque esclusi dalla garanzia i seguenti casi:
    - Se il difetto è riconducibile al trasporto.
    - Rotture di tutte le parti in vetro temperato, in particolare causate da impatto, urti durante il trasporto, movimentazione manuale degli elementi in fase di installazione e impatti accidentali durante l'utilizzo.
    - Se l'installazione non è stata eseguita dettagliatamente secondo istruzioni INDA SpA
    - Se il vizio di funzionamento è conseguente ad un intervento sul prodotto non autorizzato.
    - Se il funzionamento difettoso è conseguente alla normale usura del prodotto, alla negligenza o incuranza da parte dell'acquirente nel rispetto delle indicazioni allegate al prodotto.
    - Se il difetto è riconducibile all'utilizzo di detergenti abrasivi, a base acida, o prodotti non adatti alla pulizia di superfici laccate, verniciate, anodizzate e vetrose. Si consiglia l'utilizzo di articoli per la cura del prodotto a marchio INDA SpA
    - Se il funzionamento difettoso è conseguente a forze maggiori.
    - Manomissione del prodotto da parte dell'acquirente.
  - 5.4 INDA SpA declina qualsiasi responsabilità per eventuali danni a persone, animali o cose causati da errori di installazione, di regolazione, imperfetto utilizzo o la mancata osservanza di tutte le prescrizioni indicate nella documentazione allegata al prodotto.
  - 5.5 INDA SpA si riserva il diritto di apportare modifiche tecniche ed estetiche ai propri prodotti in qualsiasi momento senza preavviso, ivi comprese modifiche a volume e peso.
6. RESA E SPEDIZIONE PRODOTTI
  - 6.1 Il destinatario è obbligato a controllare la merce in arrivo e a contestare subito gli eventuali danni direttamente al trasportatore che ne è responsabile. È diritto del destinatario e dovere del trasportatore controllare la spedizione (senza aprire l'imballo) e apporre le eventuali riserve specifiche sul DDT del trasportatore e quello INDA SpA La sola dicitura generica: "RISERVA DI CONTROLLO" non è valida.
  - 6.2 Danno occulto: nel caso di colli rovinati, solo esternamente, questi possono essere ritirati indicando sul DDT (documento di trasporto) del trasportatore e di INDA SpA la clausola "RISERVA CONTROLLO", specificando la motivazione per cui si è posta la riserva, come previsto dal regolamento (DPR 450 2/8/85) vigente. Nel caso di rotture accertate, il destinatario deve darne comunicazione scritta a mezzo raccomandata a INDA SpA e per conoscenza al trasportatore spedendola entro e non oltre 8 giorni dal ricevimento merce.
  - 6.3 Danno accertabile: nel caso di danno evidente ed accertabile anche dal trasportatore, deve essere posta una riserva sul DDT del trasportatore e di INDA SpA indicando chiaramente quantità e codici danneggiati ed il tipo di danno esterno ed interno riscontrato. Copia dei DDT devono essere inviati all'ufficio clienti INDA SpA che successivamente darà le opportune disposizioni per l'eventuale sostituzione e reso del materiale.
  - 6.4 Diversamente da quanto previsto ai paragrafi 6.2 e 6.3, INDA SpA non riconoscerà alcun rimborso per danni o rotture riscontrate.
  - 6.5 Nessun articolo può essere reso senza l'autorizzazione scritta da INDA SpA: i resi autorizzati dovranno pervenire in porto franco al ns. stabilimento utilizzando il trasportatore ed il numero di riferimento comunicati da INDA SpA Il numero di riferimento deve essere riportato sul documento di trasporto. Se nell'accurato controllo INDA SpA si riscontrassero incurie dell'acquirente, il materiale reso sarà gravato di un importo per la copertura delle spese generali oltre ad eventuali spese di ripristino a nuovo.

## 7. TERMINI DI SPEDIZIONE DEI PRODOTTI

- 7.1 La data di spedizione dei Prodotti indicata sulla conferma d'ordine è sempre indicativa e non vincolante, salvo diversamente pattuito per iscritto.
- 7.2 Qualora INDA SpA preveda di non essere in grado di spedire i Prodotti nella data di spedizione indicata sulla conferma d'ordine, ne darà avviso all'Acquirente indicando, ove possibile, la nuova data di spedizione prevista.  
Ove il ritardo imputabile a INDA SpA superi le 6 settimane, l'Acquirente potrà risolvere il contratto relativamente ai Prodotti di cui la spedizione è ritardata, con un preavviso di 10 giorni, da comunicarsi per iscritto via telefax a INDA SpA, con esclusione di qualsiasi altro rimedio o danno.
- 7.3 Non si considera imputabile a INDA SpA l'eventuale ritardo dovuto a cause di forza maggiore o caso fortuito, atti, omissioni dell'Acquirente (ad esempio mancata comunicazione di indicazioni necessarie per la fornitura dei Prodotti).
- 7.4 Nel caso in cui, per cause non imputabili a INDA SpA, INDA SpA stessa risultasse temporaneamente o permanentemente impossibilitata ad effettuare la spedizione, INDA SpA ne darà informazione all'Acquirente e sarà sollevata dagli obblighi di spedizione per tutta la durata dell'impedimento e per tutto il tempo in cui si protraggono gli effetti ad esso conseguenti, nonché da ogni obbligo di risarcimento danni per ritardo o inadempimento nei confronti dell'Acquirente.
- 7.5 In ogni caso, e fatto salvo quanto sopra previsto per il caso di risoluzione del contratto, il risarcimento del danno effettivo subito dall'Acquirente per ritardate spedizioni imputabili a INDA SpA non potrà eccedere un importo massimo corrispondente al 5 % del prezzo netto dei Prodotti spediti in ritardo.  
Sono comunque esclusi da ogni risarcimento i danni indiretti, consequenziali o punitivi.
- 7.6 Il pagamento delle somme sopra indicate esclude qualsiasi ulteriore risarcimento del danno per mancata o ritardata spedizione dei Prodotti.

## 8. RECLAMI

- 8.1 È inteso che eventuali reclami o contestazioni, riguardanti una parte dei Prodotti consegnati o una singola spedizione di Prodotti, non danno diritto all'Acquirente di sospendere o comunque ritardare i pagamenti dei Prodotti oggetto di contestazione, né, tanto meno, di altre forniture.

## 9. FORO COMPETENTE

- 9.1 I contratti tra INDA SpA e l'Acquirente sono retti dalla legge italiana, con espressa esclusione di quanto previsto dalla Convenzione di Vienna del 1980 sulla vendita internazionale di merci.
- 9.2 Per qualsiasi controversia tra le parti, relativa ai rapporti di compravendita o fornitura, alla loro instaurazione, esecuzione o cessazione, sarà esclusivamente competente il Foro di Milano - Italia.
- 9.3 Tuttavia, in deroga a quanto sopra stabilito, INDA SpA ha comunque la facoltà di portare la controversia davanti al giudice competente presso la sede dell'Acquirente.

## 10. ECO CONTRIBUTO RAEE

- 10.1 I prezzi si intendono comprensivi da eco contributo RAEE.

## 11. FORZA MAGGIORE

- 11.1 Ciascuna parte potrà sospendere l'esecuzione dei propri obblighi contrattuali quando tale esecuzione sia resa impossibile o irragionevolmente onerosa da un impedimento imprevedibile indipendente dalla sua volontà, quale ad esempio sciopero, boicottaggio, serrata, incendio, guerra (dichiarata o non) guerra civile, sommosse e rivoluzioni, requisizioni, embargo, interruzioni di energia, ritardi nella consegna di componenti o materie prime.
- 11.2 La parte che desidera avvalersi della presente clausola dovrà comunicare immediatamente per iscritto all'altra parte il verificarsi e la cessazione delle circostanze di forza maggiore.
- 11.3 Qualora la sospensione dovuta a forza maggiore duri più di 6 settimane, ciascuna parte avrà il diritto di risolvere il presente contratto, previo un preavviso di 10 giorni, da comunicarsi alla controparte per iscritto.

## 12. PROPRIETA' INDUSTRIALE E INTELLETTUALE

- 12.1 L'Acquirente riconosce che i documenti, disegni, marchi, nomi, dati ed informazioni, (sia in forma cartacea, sia su supporto elettronico) relativi ai Prodotti sono di esclusiva proprietà di INDA SpA e non possono essere divulgati, alterati, modificati, rimossi o cancellati in qualsiasi modo.
- 12.2 L'Acquirente si impegna a non riprodurli/divulgarli a terzi ed a limitarne l'uso allo specifico Prodotto acquistato.
- 12.3 L'Acquirente ha il limitato diritto di uso dei marchi, nomi o altri segni distintivi così come di ogni altro diritto di privativa industriale o know-how produttivo e commerciale incorporato nei Prodotti e che rimane di proprietà esclusiva di INDA SpA, al solo e limitato fine di utilizzare o di rivendere i Prodotti al pubblico.  
Ogni diverso utilizzo della proprietà intellettuale di INDA SpA da parte dell'Acquirente, se non espressamente concesso per iscritto da INDA SpA, si intenderà violazione da parte dell'Acquirente dei predetti diritti esclusivi di INDA SpA, anche sotto il profilo della responsabilità contrattuale e, come tale, sarà propriamente perseguito.

## 13. INFORMATIVA SUL TRATTAMENTO DEI DATI PERSONALI

- 13.1 I dati personali dell'Acquirente verranno trattati da INDA SpA, con sede operativa in via dell'Industria, 41 - 24040 Pagazzano (BG) - Italia "Titolare del Trattamento" ai sensi del Decreto Legislativo 196/2003, come indicato nella presente informativa.
- 13.2 FINALITA' DEL TRATTAMENTO E NATURA DEL CONFERIMENTO DEI DATI  
I dati personali richiesti sono trattati per le seguenti finalità: (I) conclusione ed esecuzione dei contratti tra l'Acquirente ed INDA SpA; (II) gestione degli aspetti amministrativi e contabili connessi con l'adempimento dei suddetti contratti; (III) adempimento di obblighi di legge.  
Il conferimento dei dati per le finalità sopra descritte è facoltativo, ma indispensabile ai fini dell'instaurazione e dell'esecuzione del rapporto contrattuale tra INDA SpA e l'Acquirente, pertanto, in mancanza di conferimento, INDA SpA non potrà dar corso alla fornitura dei Prodotti richiesti.
- 13.3 MODALITÀ DEL TRATTAMENTO  
Il trattamento dei dati è effettuato nel rispetto delle modalità e dei requisiti previsti dal Decreto Legislativo 196/2003 e comprenderà tutte le operazioni o complesso di operazioni ivi disciplinate.  
Il trattamento è effettuato in forma scritta e/o su supporti cartacei e/o magnetici e/o elettronici.  
I dati sono acquisiti, registrati e trattati presso l'Ufficio Risorse Umane di INDA SpA da soggetti che lavorano all'interno dei suddetti uffici e reparti e che sono stati debitamente nominati incaricati del trattamento.
- 13.4 COMUNICAZIONE DEI DATI  
I dati potranno essere comunicati a soggetti esterni di cui INDA SpA si avvale per motivi strumentali alle finalità di cui all'art. 13.2, che precede.
- 13.5 DIRITTI DELL'INTERESSATO  
L'Acquirente potrà in qualsiasi momento esercitare i diritti di cui all'art. 7 del Decreto Legislativo 196/2003, tra cui il diritto di ottenere l'aggiornamento, la rettifica e/o l'integrazione dei dati incompleti o inesatti, nonché la loro cancellazione quando il trattamento violi norme di legge o di regolamento.



## PRICES VAT EXCLUDED Sizes in mm.

1. VALIDITY AND MODIFICATION RIGHT
  - 1.1 Any contract subscribed by INDA SpA for the sales of its products mentioned on the price list (hereinafter the "Products" and each of them the "Product") to any customer (hereafter referred to as "Buyer") will be subject to the present general sales conditions. In case of discrepancy between what is provided in these sales conditions and as stipulated in special agreements between INDA SpA and the Buyer, shall prevail as provided in these specific agreements.
  - 1.2 INDA SpA reserve the right to change and/or modify the present general sales conditions as well as the price list.
2. FEATURES OF THE PRODUCTS
  - 2.1 In each single sales contract stipulated by INDA SpA, the information regarding the Products and their use, shall be binding for both parties, unless otherwise provided for in the single contact.
  - 2.2 Any information or data on the characteristics and/or specific technical information about the Products contained in the price list are indicative and not binding.  
The Products are made with different materials: INDA SpA reserves the right to make all the changes to the Product that, without altering the essential characteristics and packaging, may be necessary and/or appropriated.
3. PRICE AND PAYMENT TERMS
  - 3.1 Where not been agreed upon a special agreement between INDA SpA and the Buyer about the Product's price, will be applied for each Product the related price list valid at the moment of the contract conclusion.  
The prices for the sale of the products listed in the price list are Ex Works or Ex central warehouse INDA SpA, VAT and any other fee or tax excluded.
  - 3.2 If the Buyer fails to make payment of the due amount within the fixed terms, INDA SpA will, at its discretion and without notice, suspend the delivery of not yet consigned Products and/or cancel further deliveries.  
After payment receipt, the delivery time of the pending orders will be re-calculated, with effect from payment, according to the production terms indicated in the price list.  
Payments for Products already delivered will not be subject to completion of the order.
  - 3.3 Without prejudice for further countermeasures allowed by the law or by the present sales conditions, and safeguarding the right of compensation for damages, INDA SpA reserves the right to apply taxes on arrears upon late payments calculated from the date in which the payment right has matured, in implementation of EU Directive 2000/35/CE, without need of any formal notice.
  - 3.4 The agreed price, unless otherwise stated, remains the same until the delivery date specified in the order confirmation.  
If, on request of the Buyer or for reasons not attributable to INDA SpA, the delivery date is postponed, INDA SpA reserves the right to revise the price applying to the Buyer increases and/or any storage costs in the meantime intervened.
4. ORDER ACCEPTANCE
  - 4.1 Orders will be considered valid only if made in writing and received by INDA SpA, via fax or e-mail at the addresses communicated by INDA SpA.
  - 4.2 No contract will be concluded between INDA SpA and the Buyer until the Buyer's order is accepted by INDA SpA in written form, through an order confirmation delivered to the attention of the Buyer.
  - 4.3 Order and/or amendments to orders shall be announced/confirmed by the Buyer in writing, by fax or via e-mail.
  - 4.4 For orders with an amount lower than € 200,00 (excluding VAT) will be request an additional charge of € 30,00 (excluding VAT).
  - 4.5 INDA SpA reserves the right to evaluate the feasibility of Products on specific request by the Buyer, to establish prices, terms and mode of delivery.
  - 4.6 We do not accept cancellations of orders for Products dedicated or made on specific request of the Buyer.
5. WARRANTY FOR PRODUCT COMPLIANCE
  - 5.1 INDA SpA guarantees its products for 24 months from the date of delivery according to the European directives. The warranty exclusively covers manufacturing irregularities or material defects. Aesthetic or functional defects must be communicated in writing to INDA SpA only and exclusively before installation, enclosing purchase and product documents.
  - 5.2 INDA SpA warranty will be exclusively valid for the repair or the replacement of defective elements: no other purchaser claims shall be considered, absolutely excluding any derived discomfort, burden or accessory cost. The claimed non-compliance must be recognized by INDA SpA authorized technical personnel.
  - 5.3 INDA SpA warranty lapses automatically in following cases:
    - If defect has reference to transport;
    - Tempered glass parts breakages;
    - If installation isn't performed following in detail INDA SpA instruction;
    - If functioning defect is due to unauthorized technical intervention on product;
    - If defective functioning is due to the normal product usury, or to the purchaser negligence or carelessness following product indication;
    - If defect is due to the use of acid based or abrasive detergents, or cleaning products not suitable for glass, anodized, lacquered or varnished surfaces. Use of INDA SpA cleaning products is suggested;
    - If defective functioning is due to a "force majeure" reason;
    - Purchaser manumission of the product.
  - 5.4 INDA SpA declines any responsibility for possible people, animals or goods damage due to installation or adjustments errors, imperfect use or no observance of all prescriptions indicated in product enclosed documents
  - 5.5 INDA SpA reserves the full right to technically and aesthetically modify the product at anytime and without previous notice, including changes in volume and weight.
6. SHIPMENT AND PRODUCTS RETURN
  - 6.1 Deliveries must be immediately inspected, in case of wrong items, and/or shortages, and/or any defect, have to be reported to the forwarder which is the only responsible for it. It is in the right of the receiver and the duty of the forwarder to control the delivery (without opening the package). A formal making specific notification on the delivery notes, the generic written phrase "subject to inspection" is not sufficient.
  - 6.2 Hidden damage: if on delivery, the goods display obvious packaging defects, they can be withdrawn, but the receiver is obliged to note the defects on the PoD marking them with "SUBJECT TO INSPECTION" and specifying reason why, as preview by the European norms in use. In case of proven breakages, the receiver must communicate it in written with a registered letter to INDA SpA and copy to the forwarder in within 7 days from the reception of the goods.
  - 6.3 Verified damage: in case of evident damage verified by the receiver and the forwarder, the damage evidence must be duly marked on PoD, indicating very clearly the quantity and the damaged products codes, verifying if the damage type is occurred on the internal or external side. A further copy of PoD must be sent to INDA SpA customer service that, successively will arrange the possible replacement upon reception of the damaged goods.
  - 6.4 Unlike what is clearly specified on the paragraphs 6.2 and 6.3, INDA SpA will not recognized any refund for the verified damage or breakage.
  - 6.5 Any Item can be returned without INDA SpA written permission. Authorized returns must be sent to our warehouse with transport fees paid, using INDA SpA authorized forwarder, indicating the communicated reference number. The reference number must be absolutely reported on PoD. Returns must be perfectly packaged. After INDA SpA control and in case of verified purchaser's neglect, the returned good will be charged of an amount equal to recover general expenses and any possible restoration costs .
7. PRODUCTS DELIVERY TERMS
  - 7.1 The Products shipment date indicated on the order confirmation is always indicative and not binding, unless otherwise agreed in writing.
  - 7.2 Where INDA SpA forecasts to be unable to ship Products by the agreed date of delivery, shall give notice to the Buyer indicating, where possible, the new foreseen date of dispatch.  
If the delay attributable to INDA SpA exceeds 6 weeks, the Buyer may terminate the contract related to the Products which shipment is delayed, with a 10 days prior notice, to be notified in writing by fax to INDA SpA, with the exclusion of any other remedy or damage.
  - 7.3 It is not considered attributable to INDA SpA any delay due to causes of force majeure or unforeseeable circumstances, acts, omissions by the Buyer (ex. non-disclosure of information necessary for the delivery of the Products).
  - 7.4 In the event that, for reasons not attributable to INDA SpA, INDA SpA itself would be temporarily or permanently unable to make the shipment, INDA SpA will give the information to the Buyer and will be relieved from the requirements of dispatch for the entire duration of the impediment and for as long as the effects arising from the impediment protract, as well as from any obligation of refund for damages, delay or non-fulfilment in respect of the Buyer.

- 7.5 In any case, and except as provided above in the event of contract termination, the compensation for actual loss incurred by the Buyer for delayed shipments due to INDA SpA will not exceed a maximum amount corresponding to 5% of the net price of the Products shipped with delay.  
Are excluded, in any case, from any compensation the indirect, consequential or punitive damages.
- 7.6 The payment of the sums shown above excludes any further compensation of damage for failure or delay in Products shipment.

## 8. COMPLAINTS

- 8.1 It is agreed that any complaints or disputes, concerning any part of the delivered Products or a single shipment of Products, do not entitle the Buyer to suspend or delay the payment of the Products subject to dispute, nor, even less, other supplies.

## 9. POINT OF JURISDICTION

- 9.1 Contracts between INDA SpA and the Buyer are governed by Italian law, with the express exclusion of what required by the Wien Convention of 1980 on the international sale of goods.
- 9.2 For any dispute between the parties relating to sale or supply relations, to their establishment, performance or termination, shall have exclusive jurisdiction the Court of Milan – Italy.
- 9.3 However, notwithstanding the provision above, INDA SpA still has the power to bring the dispute before the competent court at the site of the Buyer.

## 10. WEEE CONTRIBUTION

- 10.1 The prices do not include the WEEE contribution

## 11. FORCE MAJEURE

- 11.1 Either party may suspend performance of its contractual obligations when such performance is rendered impossible or unreasonably onerous by an unforeseeable impediment beyond its control, such as strike, boycotting, lockouts, fire, war (declared or not), civil war, insurrections and revolutions, requisitions, embargo, power interruptions, delays in delivery of components or materials.
- 11.2 The party wishing to make use of this clause must notify immediately in writing to the other part the occurrence and cessation of the circumstances of force majeure.
- 11.3 If the suspension due to force majeure lasts more than 6 weeks, each party shall be entitled to terminate this contract, with a 10 days prior notice, to be notified to the other party in writing.

## 12. INDUSTRIAL AND INTELLECTUAL PROPERTY

- 12.1 The Buyer acknowledges that the documents, drawings, logos, names, data and information (both in paper form, either in electronic form) are exclusive property of INDA SpA and can not be disclosed, altered, modified, removed or erased in any way.
- 12.2 The Buyer agrees not to reproduce/disclose to third parties and to restrict their use to the specific Product purchased.
- 12.3 The Buyer shall have the limited right to use trademarks, names or other distinguishing marks as well as any other industrial executive right or manufacturing and commercial know-how associated with the goods, which remains exclusive property of INDA SpA, to the sole and limited purpose to utilize or resell the goods to the public.  
Any other use of the INDA SpA intellectual property by the Buyer, unless expressly granted in writing by INDA SpA, will be considered an infringement of the INDA SpA exclusive rights by the Buyer, also in terms of contractual liability and, as such, will be properly prosecuted.

## 13. INFORMATION ON THE PROCESSING OF PERSONAL DATA

- 13.1 The Buyer's personal data will be processed by INDA SpA, established in via dell'Industria, 41 - 24040 Pagazzano (BG) - Italia, "Data Controller" under the Legislative Decree No. 196/2003, as indicated in this statement.
- 13.2 PURPOSE OF TREATMENT AND NATURE OF DATA SUBMISSION  
The personal information requested is used for the following purposes: (I) conclusion and execution of contracts between the Buyer and INDA SpA, (II) management of administrative and accounting aspects related to the performance of such contracts, (III) the fulfilment of legal obligations.

Providing data for the purposes described above is optional, but essential in the establishment and enforcement of the contractual relationship between INDA SpA and the Buyer, therefore, in the absence of data submission, INDA SpA will not be able to execute the supply of the required Products.

- 13.3 Data processing is performed in accordance with the procedures and requirements as required by Legislative Decree No. 196/2003 and include all operations or series of transactions covered therein. The treatment is done in writing and/or on paper and/or magnetic and/or electronic supports.  
The data are acquired, recorded and processed at the Office of Human Resources of INDA SpA by persons working within these offices and departments and have been duly appointed to the treatment.
- 13.4 DATA COMMUNICATION  
The data may be communicated to external entities to which INDA SpA relies for instrumental reasons to the purposes of Article. 13.2, above.
- 13.5 RIGHTS OF THE BUYER  
The Buyer may at any time exercise its rights under Art. 7 of the Legislative Decree No. 196/2003, including the right to obtain updating, rectification and/or integration of incomplete or inaccurate data, and their cancellation when the treatment violates laws or regulations.

**PRIX H.T.**

Les dimensions sont indiquées en mm.

1. VALIDITE ET DROIT DE MODIFICATION
  - 1.1 Tout contrat souscrit par INDA SpA pour la vente de ses produits répertoriés dans ses tarifs (ci-après les "Produits") à tout client (ci-après l'"Acheteur" ou "Client") est soumis aux présentes conditions générales de vente.  
En cas de désaccord entre ce qui est prévu sur les présentes conditions générales de vente et ce qui est négocié dans des accords spécifiques entre INDA SpA et l'Acheteur, prévaudra ce qui a été négocié dans des accords spécifiques.
  - 1.2 INDA SpA se réserve le droit de modifier et/ou varier les présentes conditions générales de vente ainsi que ses tarifs.
2. CARACTERISTIQUES DES PRODUITS
  - 2.1 Dans tout contrat de vente stipulé par INDA SpA, les éventuels renseignements concernant les Produits et leur utilisation, engagent les deux parties sauf indication contraire stipulée expressément dans le contrat de vente.
  - 2.2 Les éventuelles informations ou données sur les caractéristiques des Produits répertoriés dans les tarifs sont données à titre indicatif et sans engagement.  
Les produits sont réalisés à partir de plusieurs matériaux:  
INDA SpA se réserve le droit d'apporter des modifications qui pourraient s'avérer nécessaires ou opportunes, sans altérer les caractéristiques essentielles et les emballages des Produits.
3. PRIX ET CONDITIONS DE PAIEMENT
  - 3.1 Sauf indication contraire d'un accord spécifique entre INDA SpA et l'Acheteur à propos du prix des Produits, le prix appliqué est le prix du tarif en vigueur au moment de la conclusion du contrat de vente.
  - 3.2 En cas de retard de règlement de la part de l'Acheteur, INDA SpA se réserve le droit, sans aucun préavis, de suspendre toute livraison en cours et/ou d'annuler toute livraison à venir.  
A réception du règlement, les délais de livraison des commandes suspendues seront recalculés sur la base des délais de fabrication indiqués dans les tarifs.  
Le paiement de Produits déjà livrés ne peut en aucun cas être subordonné à la livraison d'éventuels produits restants à livrer.
  - 3.3 Toute prorogation d'échéance, avec ou sans l'accord de l'Inda, entraînera, conformément aux dispositions légales, la mise en charge du client d'intérêts de retard calculés selon la directive communautaire 2000/35/CE. En outre, tous les frais entraînés par les retards de paiement, notamment ceux de recouvrement et de contentieux, sont à la charge du Client défaillant.
  - 3.4 Le prix négocié, sauf indication contraire, reste inchangé jusqu'à la date de livraison indiquée sur l'accusé de réception de la commande.  
Toutefois, pour faire suite à la demande de l'Acheteur ou pour motifs non imputables à INDA SpA, si la date de livraison est reportée, INDA SpA se réserve le droit de modifier le prix à la hausse notamment pour tenir compte d'éventuels frais de stockage non prévus au moment de la vente.
4. ACCEPTATION DES COMMANDES
  - 4.1 Les commandes sont considérées valables seulement si stipulées par écrit et reçues par INDA SpA, par fax ou courriel aux adresses en vigueur.
  - 4.2 Le contrat de vente n'est parfait qu'après acceptation écrite de la commande par INDA SpA, concrétisée par l'envoi d'un accusé de réception de commande à l'Acheteur.
  - 4.3 Toute commande et/ou modification de commande de la part de l'Acheteur doit être communiquée/confirmée par écrit par fax ou courriel.
  - 4.4 Les commandes dont le montant est inférieur à 200 Euro HT brut donneront lieu à la mise en charge du Client d'une participation aux frais de gestion de commande de 20 Euro.
  - 4.5 INDA SpA se réserve le droit d'étudier la faisabilité de produits "sur mesure" sur demande spécifique du Client, d'établir un devis, les modalités et les conditions de livraison.
  - 4.6 Aucune annulation de commande de produits spéciaux ou sur mesure réalisés à la demande du Client ne pourra être acceptée.
5. GARANTIE ET CONFORMITE DES PRODUITS
  - 5.1 INDA SpA garantit ses propres produits pour une période de 24 mois à compter de la date d'achat, selon les dispositions du Code Civil et des directives Européennes en la matière. La garantie couvre exclusivement les vices et défauts de fabrication ou d'assemblage. Les défauts d'ordre esthétique ou structurel doivent être communiqués par écrit à INDA SpA seulement et exclusivement avant l'installation, en y alléguant les documents d'achat et de produit.
  - 5.2 La garantie engage INDA SpA seulement à la réparation et/ou au remplacement des éléments défectueux : sont cependant exclus les prétentions supplémentaires de la part de l'acquéreur, et exclus toute demande d'indemnisation dérivant de la gêne occasionnée, ou charge ou coût accessoire relatif. La garantie ne couvre pas les frais de main-d'œuvre et ceux résultant des opérations suivantes : démontage, remontage, transport sur site, etc.... La non conformité devra être identifiée et confirmée uniquement par du personnel autorisé par INDA SpA .
  - 5.3 Sont cependant exclus de la garantie les cas suivants:
    - si le défaut est dû au transport;
    - casse des parties en verre trempé;
    - si l'installation n'a pas été effectuée scrupuleusement selon les instructions de INDA SpA ;
    - si le vice de fonctionnement résulte d'une intervention sur le produit effectuée sans autorisation;
    - si le fonctionnement défectueux provient de l'usure normale du produit, d'une négligence ou d'un défaut d'entretien de la part de l'acheteur eu égard aux indications alléguées au produit;
    - si le défaut résulte de l'utilisation de détergents abrasifs, à base acide, ou de produits non adaptés à l'entretien de surfaces laquées, vernies, anodisées ou vitrées. Est conseillée l'utilisation des produits d'entretien de marque « INDA SpA » ;
    - si le fonctionnement défectueux résulte de la force majeure;
    - altération, modification du produit du fait de l'acquéreur.
  - 5.4 INDA SpA décline toute responsabilité pour d'éventuels dommages causés à des personnes, des animaux ou des objets et dus à des erreurs d'installation, de réglage, à une utilisation inappropriée ou à la carence d'observation des prescriptions indiquées dans la documentation alléguée au produit.
  - 5.5 INDA SpA se réserve le droit d'apporter des modifications techniques et esthétiques à ses propres produits à tout moment et sans préavis, y compris les changements dans le volume et le poids.
6. LIVRAISONS ET RETOURS
  - 6.1 Il incombe au destinataire de vérifier l'état des marchandises à l'arrivée, en présence du livreur. Le destinataire doit, par conséquent, ouvrir et vérifier la marchandise à la livraison devant le transporteur.
  - 6.2 En cas de casse ou d'avarie, le destinataire doit impérativement le noter sur le récépissé de transport et sur le bon de livraison, et refuser le ou les colis cassés ou abîmés. En cas de colis manquant, le destinataire doit l'indiquer sur le récépissé de transport et sur le bon de livraison.
  - 6.3 En France, l'Article 105 du Code du Commerce stipule que les réserves portées sur le récépissé de transport et sur le bon de livraison doivent être suffisamment claires, précises et explicites. En Belgique, ce même principe est applicable. Exemple de réserves admises « refusé car colis cassé », « refusé car produit abîmé », « manque 1 colis ». Attention, la mention « sous réserve de déballeage » ne pourra en aucun cas être prise en compte en cas de litige car elle n'est pas admise par les tribunaux. Toujours selon l'Article 105 du Code du Commerce en France, une confirmation des réserves par Lettre Recommandée avec Accusé de Réception doit être expédiée au transporteur dans les 48 heures suivant la réception de la marchandise et une copie doit nous en être adressée. Pour la Belgique, le client doit se conformer à la même procédure.
  - 6.4 En l'absence de réserves expressément prévues sur le récépissé de transport et sur le bon de livraison, notre responsabilité ne pourra en aucun cas être engagée et toute réclamation ne pourra être prise en compte et donner lieu à une substitution gratuite de l'Article.
  - 6.5 Les commandes sont sujettes à acceptation de INDA SpA  
Aucune commande ne pourra être annulée ou modifiée sans le consentement de INDA SpA, qui se réserve le droit de facturer les éventuels frais inhérents.  
La confirmation de l'acceptation de modifications ou annulations et la facturation d'éventuels frais supplémentaires, sera confirmée par INDA SpA uniquement par écrit.  
En cas d'acceptation écrite par INDA SpA de retour de marchandises, le client-expéditeur devra mettre à disposition et correctement emballé pour le transport, le matériel autorisé en retour à la date de retrait indiquée sur l'autorisation de retour.  
Dans le cas contraire, INDA SpA se réserve le droit de facturer au client-expéditeur les coûts engendrés par la présentation du transporteur.
7. CONDITIONS D'EXPEDITION DES PRODUITS
  - 7.1 Les délais de production et/ou d'expédition des Produits indiqués sur la confirmation de commande ne sont donnés qu'à titre purement indicatif.
  - 7.2 Leur dépassement ne saurait entraîner des indemnités de retard ou dommages et intérêts. Il ne pourrait en outre constituer un motif d'annulation, qu'en cas de retard supérieur à 6 semaines non justifié par une circonstance indépendante de la volonté de INDA SpA (notamment force majeure, événement imprévu, guerre, acte de terrorisme, incendie, grève, accident, retards dus aux

- fournisseurs de la société ou aux transporteurs, commande incomplètement ou non correctement renseignée par l'Acheteur).
- 7.3 Dans l'hypothèse où le retard dépasse 6 semaines, l'Acheteur a la faculté d'annuler la commande en informant INDA SpA par écrit (fax) en respectant un préavis de 10 jours.
- 7.4 Dans tous les cas, l'éventuelle prise en charge pour dommages subis suite à un retard de livraison imputable à INDA SpA, ne pourra être supérieure à un montant correspondant à 5% du prix net des Produits livrés en retard.
- 7.5 Le paiement des sommes indiquées au point 7.4. annule toute autre demande de dédommagement pour retard de livraison.

## 8. RECLAMATIONS

- 8.1 Les échéances de paiement ne peuvent être suspendues, retardées ou compensées par l'Acheteur sous aucun prétexte, même en cas de litige, réclamation et/ou contestation en cours, sous peine notamment de suspension de toutes les commandes en cours par INDA SpA

## 9. JURIDICTION COMPETENTE

- 9.1 Les contrats entre INDA SpA et l'Acheteur sont dirigés par la loi italienne, avec exclusion de ce que prévu par la Convention de Vienne de 1980 sur la vente internationale de marchandises.
- 9.2 Sera seul compétent en cas de litige de toute nature ou de contestation relative notamment à la formation ou l'exécution de la commande, le Tribunal de Commerce dont relève le siège social de INDA SpA, à moins que celle-ci ne préfère saisir toute autre juridiction compétente.
- 9.3 Toutefois, en dérogation à ce qui est mentionné ci-dessus, INDA SpA se réserve la faculté de porter la contestation devant le Tribunal de compétence du siège social du client.

## 10. ECOTAXE RAEE

- 10.1 Les prix indiqués par INDA s'entendent hors ECOTAXE RAEE.

## 11. FORCE MAJEURE

- 11.1 Chaque partie pourra suspendre l'exécution de ses obligations contractuelles si celle-ci est rendue impossible ou anormalement onéreuse par un événement imprévu indépendant de sa volonté, notamment: grève, Boycot, incendie, acte de terrorisme, guerre (déclarée ou pas), guerre civile, révoltes et révolutions, réquisitions, embargo, interruption de la distribution énergétique, accidents, retards dus aux Fournisseurs ou aux transporteurs.
- 11.2 La partie qui souhaiterait faire jouer cette clause devra communiquer par écrit à l'autre partie le début et la fin des circonstances de force majeure.
- 11.3 Dans le cas où la suspension pour force majeure dure plus de 6 semaines, chacune des parties aura le droit de mettre un terme au contrat par écrit en respectant un préavis de 10 jours.

## 12. PROPRIETE INDUSTRIELLE ET INTELLECTUELLE

- 12.1 L'Acheteur reconnaît que les documents, dessins, marques, noms, données et informations délivrées par INDA SpA (imprimés sur papier ou en version électronique) sont la propriété exclusive de INDA SpA et ne peuvent en aucune manière être divulgués, altérés, modifiés, effacés en totalité ou en partie.
- 12.2 L'Acheteur s'engage à ne pas les reproduire ni les divulguer à des tiers et en limiter l'usage à la stricte utilisation du Produit acheté.
- 12.3 L'Acheteur peut exercer un droit d'utilisation des marques, noms ou autre signe distinctif ainsi que tout autre droit de propriété industrielle, intellectuelle et commerciale exclusivement réservé à INDA SpA, dans les limites liées au seul cadre d'utilisation et de revente des Produits à ses clients. Tout autre utilisation faite par l'Acheteur de la propriété intellectuelle d'INDA SpA, sauf dérogation écrite et expresse d'INDA SpA, sera considérée comme une violation des droits sus-cités exclusifs d'INDA SpA de la part de l'Acheteur, y compris d'un point de vue de la responsabilité contractuelle, et sera poursuivie comme telle.

## 13. NOTE D'INFORMATION SUR LE TRAITEMENT DES DONNÉES PERSONNELLES

- 13.1 Les données personnelles de l'Acheteur seront traitées par INDA SpA via dell'Industria, 41 - 24040 Pagazzano (BG) - Italia, «Titulaire du Traitement» aux sens du Décret Législatif 196/2003, comme indiqué dans le présente note d'information.

## 13.2 FINALITE DU TRAITEMENT ET DE LA NATURE DE L'ATTRIBUTION DES DONNÉES

Les données personnelles demandées sont traitées pour les buts suivants: (I) conclusion et exécution des contrats entre l'Acheteur et INDA SpA; (II) gestion des aspects administratifs et comptables avec l'accomplissement des susdits contrats; (III) accomplissement d'obligations de loi.

L'attribution des données pour les buts décrits ci-dessus est facultative, mais indispensable aux fins de l'instauration et de l'exécution du rapport contractuel entre INDA SpA et l'Acheteur, par conséquent, en manque d'attribution, INDA SpA ne pourra pas donner cours à la fourniture des Produits demandés.

## 13.3 MODALITE DU TRAITEMENT

Le traitement des données est effectué dans le respect des modalités et des conditions requises prévues par le Décret Législatif 196/2003 et comprendra toutes les opérations ou complexe d'opérations là disciplinées. Le traitement est effectué sous forme écrite et/ou sur supports papiers et/ou magnétiques et/ou électroniques. Les données sont acquises, enregistrées et traitées par le Bureau Ressources Humaines de INDA SpA par les personnes qui travaillent à l'intérieur des susdits bureaux et des rayons et qui ont été nommées et chargées du traitement.

## 13.4 COMMUNICATION DES DONNÉES

Les données pourront être communiquées à des personnes externes dont INDA SpA se sert pour des raisons instrumentales aux buts de l'art. 13,2, qui précède.

## 13.5 DROITS DE L'INTÉRESSÉ

L'Acheteur pourra à tout moment exercer les droits dont l'art. 7 du Décret Législatif 196/2003, parmi lequel le droit d'obtenir la mise à jour, le changement et/ou l'intégration des données incomplètes ou inexactes, ainsi que leur élimination lorsque le traitement viole des règles de loi ou de règlement.



## PRECIOS SIN IVA

Las medidas son en mm.

1. VALIDEZ Y DERECHO DE MODIFICACION
  - 1.1 Cualquier contrato suscrito por INDA SpA o INDA ESPAÑA S.L., de ahora en adelante denominada "INDA", para la venta de sus propios productos indicados en la tarifa de precios (de ahora en adelante los "Productos" y cada uno de ellos el "Producto") a cualquier cliente (de ahora en adelante el "Comprador") estará sujeto a las presentes condiciones generales de venta. En caso de discordancia entre lo previsto en las presentes condiciones generales de venta y aquello pactado en acuerdos específicos entre INDA y el Comprador, prevalecerá lo previsto en dichos acuerdos específicos.
  - 1.2 INDA se reserva el derecho de modificar y/o variar las presentes condiciones de venta como así también la lista de precios.
2. CARACTERISTICAS DE LOS PRODUCTOS
  - 2.1 En los singulares contratos de venta estipulados por INDA, las eventuales informaciones relativas a los Productos y el uso de ellos, son vinculantes para las partes, salvo que las partes lo hubiesen previsto diversamente en el singular contrato de venta.
  - 2.2 Eventuales informaciones o datos sobre las características y/o especificaciones técnicas de los Productos incluidos en la tarifa de precios, son indicativos y no vinculantes. Los Productos se realizan con distintos materiales: INDA se reserva el derecho de aportar a los Productos las modificaciones que, sin alterar las características esenciales y de embalaje, pudiesen resultar necesarias y/u oportunas.
3. PRECIO Y CONDICIONES DE PAGO
  - 3.1 En el caso que no se hubiese estipulado un acuerdo específico entre INDA y el Comprador, respecto al precio de los Productos, se aplicará para cada Producto el precio relativo a la tarifa en vigor en el momento de la conclusión del contrato.
  - 3.2 En el caso que el Comprador no efectuase el pago del total de su deuda respetando las condiciones pactadas, INDA podrá, a su discreción y sin ningún preaviso, suspender las entregas en curso relativas a los Productos aún no entregados y/o anular ulteriores entregas. Una vez efectivizado el pago, los tiempos de expedición de los pedidos que hubiesen quedado suspendidos, se recalcularán a partir de la misma fecha de pago, en base a los tiempos de producción indicados en la tarifa de precios. El pago de los Productos ya entregados, no estará subordinado a la entrega completa del resto del pedido.
  - 3.3 Sin ningún perjuicio por las soluciones ulteriores consentidas por la ley y por las presentes condiciones generales de venta, excepto el derecho de resarcimiento de daños, INDA se reserva el derecho de aplicar tasas de mora a los pagos retrasados, a partir de la fecha en la que se haya devengado el derecho de pago, en conformidad con la Directiva comunitaria 2000/35/CE, sin necesidad de un requerimiento formal de mora.
  - 3.4 El precio pactado, salvo indicación contraria, queda invariado hasta la fecha de expedición indicada en la confirmación del pedido. Si, bajo solicitud del Comprador o por motivos no imputables a INDA, la fecha de expedición fuese pospuesta, INDA se reserva el derecho de reaver el precio aplicando al Comprador eventuales aumentos y/o gastos de permanencia y almacenaje durante el tiempo transcurrido.
4. ACEPTACION DE LOS PEDIDOS
  - 4.1 Los pedidos serán considerados válidos sólo si son efectuados por escrito y recibidos por INDA, vía telefax o vía e-mail, en las direcciones comunicadas por la misma.
  - 4.2 Ningún contrato se concluirá entre INDA y el Comprador hasta que no haya habido una aceptación escrita del pedido del Comprador por parte de INDA, a través de la confirmación del pedido enviada para conocimiento del Comprador.
  - 4.3 Pedidos y/o modificaciones de pedidos deberán ser comunicados/ confirmados por escrito por el Comprador trámite telefax o e-mail.
  - 4.4 Los pedidos de importe inferior a 150 euros pvp (IVA exc.) tendrán un cargo adicional de 15 euros netos por gastos generales de gestión de pedido.
  - 4.5 INDA se reserva el derecho de evaluar la factibilidad de productos según una específica solicitud del Comprador, de establecer los precios, la modalidad y el plazo de entrega.
  - 4.6 No se aceptan anulaciones de pedidos de Productos dedicados o realizados bajo exclusiva petición del Comprador.
5. GARANTIA DE CONFORMIDAD DE LOS PRODUCTOS
  - 5.1 INDA SpA garantiza los productos por 24 meses desde la fecha de adquisición y en cualquier caso en los términos de la legislación española vigente y la normativa europea. La garantía cubre exclusivamente vicios y defectos de fabricación o ensamblaje. Defectos estéticos o estructurales deberán ser comunicados por escrito a INDA SpA sólo y exclusivamente antes de su instalación, adjuntando el documento de compra y de producto.
  - 5.2 La garantía obliga a INDA SpA sólo a la reparación y/o sustitución de los elementos defectuosos: se excluye pues cualquier otra pretensión por parte del comprador y excluye también cualquier tipo de indemnización u otro tipo de coste adicional. La no conformidad del producto deberá ser confirmada sólo por parte de personal autorizado por INDA SpA
  - 5.3 Se excluyen en cualquier caso de la garantía los siguientes casos:
    - Si el defecto se debe al transporte.
    - Rotura de los componentes de cristal templado.
    - Si la instalación no se ha seguido detalladamente según las instrucciones de INDA SpA
    - Si el defecto de funcionamiento se debe a una intervención no autorizada sobre el producto.
    - Si el funcionamiento defectuoso se debe a la negligencia o no observancia de las indicaciones de uso del producto.
    - Si el defecto es provocado por el uso de detergentes abrasivos, de base ácida, o productos no aptos a la limpieza de superficies laqueadas, barnizadas, anodizadas y vítreas. Se aconseja el uso de productos con marca INDA SpA
    - Si el mal funcionamiento es consecuencia de fuerza mayor.
    - Modificación o manipulación indebida del producto por parte del comprador.
  - 5.4 INDA SpA declina cualquier responsabilidad por eventuales daños a personas, animales u objetos causados por error de instalación, regulación, mal uso o no observancia de todas las prescripciones indicadas en la documentación que acompaña al producto.
  - 5.5 INDA SpA se reserva el derecho de modificar las propiedades técnicas y/o estéticas de los productos sin previo aviso, incluidos los cambios en el volumen y el peso.
6. DESTINO Y EXPEDICION DE LOS PRODUCTOS
  - 6.1 El destinatario está obligado a comprobar la mercancía a su recepción y señalar rápidamente los daños apreciados directamente al transportista, que es responsable de la entrega correcta, y comunicar a nuestro departamento en el plazo máximo de 24 horas el daño observado.
  - 6.2 Daño oculto: en el caso de mercancía defectuosa externamente, puede ser retirada indicándolo en el documento de transporte y el albarán de entrega con la cláusula de reserva de control. En el caso de rotura interior evidenciada posteriormente, se debe comunicar por correo certificado o anticipando por fax a INDA SpA en el plazo de 24 horas desde la recepción de la mercancía.
  - 6.3 Daño evidente: en este caso se debe indicar en el documento de transporte y el albarán indicando claramente cantidades y códigos correspondientes, así como el tipo de daño encontrado y mandar copia a INDA SpA en el plazo máximo de 24 horas para la eventual sustitución del material.
  - 6.4 En cualquier caso diferente a los mencionados en los puntos 6.2 y 6.3 no se efectuará ningún reembolso por daños o roturas.
  - 6.5 Ningún artículo puede ser devuelto sin la autorización de INDA SpA Las devoluciones autorizadas deberán enviarse a portes pagados por el comprador, utilizando el transportador indicado por INDA SpA y especificando la referencia correspondiente, pudiendo ser gravadas con un importe a determinar para cubrir gastos generales de gestión.



## 7. TERMINOS DE EXPEDICION DE LOS PRODUCTOS

- 7.1 La fecha de expedición de los Productos señalada en la confirmación de pedido, es siempre indicativa y no vinculante, excepto cuando se hubiese pactado diversamente y por escrito.
- 7.2 En caso que INDA prevea no poder enviar los Productos en la fecha de expedición indicada en la confirmación de pedido, avisará al Comprador indicando, siempre que sea posible, la nueva fecha de expedición prevista.  
Cuando el retraso imputable a INDA supere las 6 semanas, el Comprador podrá resolver el contrato relativo a los Productos de los cuales la expedición está retrasada, con un preaviso de 10 días, comunicándolo por escrito vía telefax a INDA, con exclusión de cualquier otro remedio o daño.
- 7.3 No se considera imputable a INDA un eventual retraso debido a causas de fuerza mayor o caso fortuito, actos, omisiones del Comprador (por ejemplo la falta de comunicación de indicaciones necesarias para el su ministro de los Productos).
- 7.4 En caso que por causas no imputables a INDA, ésta resultase, temporánea o permanentemente imposibilitada a efectuar la expedición, INDA informará al Comprador y será eximida de las obligaciones de expedición por la entera duración del impedimento y por todo el tiempo en el cual se prolonguen los efectos derivados, así como de cualquier obligación de resarcimiento por daños por retraso o incumplimiento para con el Comprador.
- 7.5 De todos modos, y sin perjuicio de lo previsto anteriormente para el caso de resolución del contrato, la indemnización del daño efectivo sufrido por el Comprador por retrasos en las entregas imputables a INDA no podrá exceder un importe máximo correspondiente al 5% del precio neto de los Productos enviados con retraso.  
Quedan excluidos de cualquier indemnización los daños indirectos, consecuentes o punitivos.
- 7.6 El pago de las sumas indicadas anteriormente excluye cualquier ulterior indemnización del daño por falta o retraso en el envío de los Productos.

## 8. RECLAMACIONES

- 8.1 Se entiende que posibles reclamaciones o contestaciones, relativas a una parte de los Productos entregados o una única expedición de Productos, no dan derecho al Comprador a suspender o retrasar los pagos de los Productos objeto de contestación, ni, mucho menos, de otros suministros.

## 9. FUERO COMPETENTE

- 9.1 Los contratos entre INDA y el Comprador se rigen según la ley italiana, con exclusión expresa de lo previsto por la Convención de Viena de 1980 sobre venta internacional de mercancías.
- 9.2 Cualquier controversia entre las partes, concerniente a las relaciones de compra-venta o suministro, a su instauración, ejecución o cese, será exclusivamente bajo competencia del Fuero de Milano – Italia.
- 9.3 Sin embargo, como excepción a lo establecido en el punto anterior, INDA tiene la facultad de llevar la controversia ante el juez competente en la sede del Comprador.

## 10. FUERZA MAYOR

- 10.1 Cualquiera de las partes podrá suspender la ejecución de sus propias obligaciones contractuales cuando tal ejecución se rinda imposible o irracionalmente onerosa por un impedimento imprevisto independiente de su voluntad como por ejemplo huelga, boicot, cierre patronal, incendio, guerra (declarada o no), guerra civil, revueltas y revoluciones, requisas, embargo, interrupciones de energía, retrasos en la entrega de componentes o materias primas.
- 10.2 La parte que desee hacer uso de la presente cláusula, deberá comunicar inmediatamente y por escrito a la otra parte, la manifestación y el cese de las circunstancias de fuerza mayor.
- 10.3 En el momento en el que la suspensión debida a fuerza mayor durase más de 6 semanas, cualquiera de las partes tendrá el derecho de resolver el presente contrato, previo preaviso de 10 días, a comunicar a la contraparte por escrito.

## 11. PROPIEDAD INDUSTRIAL E INTELECTUAL

- 11.1 El Comprador reconoce que los documentos, diseños, marcas, nombres, datos e informaciones, (ya sea en forma impresa, como en formato electrónico) relativos a los Productos son de exclusiva propiedad de INDA y no pueden ser divulgados, alterados, modificados, borrados o cancelados de ningún modo.
- 11.2 El Comprador se compromete a no reproducirlos/divulgarlos a terceros y a limitar el uso al específico Producto comprado.
- 11.3 El comprador goza del derecho limitado del uso de las marcas, nombres u otros signos distintivos, así como de cualquier otro derecho de propiedad industrial o know-know productivo y comercial incorporado en los Productos, que es de exclusiva propiedad de INDA, al único y limitado fin de utilizar o revender los Productos al público. Cada uso diverso de la propiedad intelectual de INDA por parte del Comprador, sin consentimiento escrito concedido por INDA, se percibirá como violación por parte del Comprador de los mencionados derechos exclusivos de INDA, aún bajo el perfil de la responsabilidad contractual y, como tal, será perseguido propiamente.

## 12. INFORMACION SOBRE EL TRATAMIENTO DE LOS DATOS PERSONALES

- 12.1 Los datos personales del Comprador serán tratados por INDA SpA via dell'Industria, 41 - 24040 Pagazzano (BG) - Italia, "Titular del Tratamiento" al amparo del D. Lgs. 196/2003, como indicado en la presente comunicación.
- 12.2 FINALIDAD DEL TRATAMIENTO Y NATURALEZA DE LA CONCESIÓN DE LOS DATOS  
Los datos personales requeridos son tratados con la finalidad siguiente: (I) conclusión y ejecución de contratos entre el Comprador e INDA; (II) gestión de los aspectos administrativos y contables relacionados con el cumplimiento de los mencionados contratos; (III) cumplimiento de las obligaciones de ley.  
La concesión de los datos para las finalidades más arriba descritas es facultativo, pero indispensable para la instauración y ejecución de la relación contractual entre INDA y el Comprador, por lo tanto, a falta de concesión, INDA no podrá dar curso al suministro de los Productos requeridos.
- 12.3 MODALIDAD DEL TRATAMIENTO  
El tratamiento de los datos se efectúa en cumplimiento de las normas y requisitos previstos por el D.Lgs. 196/2003 y comprenderá todas las operaciones o serie de operaciones contempladas por el mismo. El tratamiento se efectuará de manera escrita y/o sobre soporte de papel y/o magnético y/o electrónico.  
Los datos son adquiridos, registrados y tratados a través de la Oficina de Recursos Humanos de INDA por sujetos que trabajan en el interior de dichas oficinas y departamentos y que están debidamente nominados/encargados del tratamiento.
- 12.4 COMUNICACION DE LOS DATOS  
Los datos podrán ser comunicados a sujetos externos, a los cuales INDA se avala por motivos instrumentales, a los fines del art. 12.2 precedente.
- 12.5 DERECHOS DEL INTERESADO  
El comprador podrá en cualquier momento ejercitar sus derechos en virtud del art. 7 del D.Lgs 196/2003, incluyendo el derecho de obtener la actualización, la rectificación y/o la integración de los datos incompletos o inexactos, así como también su cancelación, cuando el tratamiento viole normas de ley o de reglamento.

**Indice Progressivo / Progressive index**  
**Index par ordre croissant / Índice de códigos**

Cod.	Stock	€	Pag.	Cod.	Stock	€	Pag.	Cod.	Stock	€	Pag.
A0144AAP		55,40	301	A0494DCR		74,70	204	A13680CR		173,20	234
A0144BAP		68,30	301	A05090CR		14,80	190	A1390BCR		67,90	140/264
A0146ACR		52,40	300	A05090CR003		10,10	190	A1390CCR		69,40	140/264
A0146BCR		69,40	300	A05140CR		56,50	196/225	A13950CR		66,20	140/264
A0146CCR		102,90	300	A05140CR003		47,60	225	A15100CR03		73,40	107
A01470CR		58,60	301	A0525CAL		83,50	226	A15100CR21		73,40	107
A0148ACR		92,10	300	A0525CAL007		74,70	226	A15100NE03		84,50	107
A0148BCR		126,70	300	A05300CR03		53,40	232	A15100NE21		84,50	107
A0148ECR		54,10	300	A05300CR037		49,60	232	A15110CR03		73,40	107
A0148GCR		82,30	300	A05480CR003		16,10	301	A15110CR21		73,40	107
A0148MCR		109,40	300	A05610CR		14,80	211	A15110NE03		84,50	107
A0198BWW005		37,30	304	A05610CR007		13,40	211	A15110NE21		84,50	107
A0199BWW005		37,30	304	A05620CR003		19,00	209	A15120CR03		103,40	107
A02591QD		74,70	302	A05670CR		92,10	214	A15120CR21		103,40	107
A02592QD		207,90	302	A05840CR		262,00	293	A15120NE03		118,90	107
A02593QD		134,40	303	A05850CR		285,80	293	A15120NE21		118,90	107
A0259AQA		73,70	303	A07140WW		38,30	196/226	A15150CR		96,40	106
A0263AQA		134,40	303	A07250AL		77,00	227	A15150NE		110,90	106
A03750CR		102,90	272	A07250AL007		60,70	227	A1518ACR		70,50	106
A0401CAL		67,30	229	A1010ACR03		55,40	83	A1518ANE		81,20	106
A04030AL		19,70	236	A1010ANS03		61,00	83	A1518BCR		78,10	106
A04030AL007		18,30	236	A10110CR03		55,40	84	A1518BNE		90,00	106
A0407ACR		60,70	217	A10110NS03		61,00	84	A1518CCR		82,30	106
A04100CR03		40,70	218	A10120CR03		83,50	83	A1518CNE		94,80	106
A0410NCR007		24,20	218	A10120NS03		92,00	83	A1518DCR		86,70	106
A04110CR		68,30	213	A10150CR		144,00	81	A1518DNE		99,70	106
A04110CR007		62,90	213	A10150NS		158,60	81	A1520ACR		29,90	106
A0411ACR		69,40	213	A10160CR		55,40	81	A1520ANE		34,50	106
A04140CR		68,30	196/225	A10160NS		60,90	81	A1525BCR		96,40	109
A0415AAC		54,20	205	A1018ACR		63,90	80	A1525BNE		110,90	109
A0415ABZ		62,90	205	A1018ANS		70,40	80	A1527ACR		131,30	109
A0415ACG		54,20	205	A1018BCR		68,30	80	A1527ANE		150,50	109
A0415ACR		38,50	205	A1018BNS		75,20	80	A15490CR		84,50	109
A0415ADR		62,90	205	A1018CCR		72,70	80	A15510CR		171,00	110
A0415ANE		46,70	205	A1018CNS		79,90	80	A18090AC21		108,50	127
A0415AOR		62,90	205	A1018DCR		105,10	80	A18090BZ21		123,90	127
A0415AWM		46,70	205	A1018DNS		115,60	80	A18090CG21		139,50	127
A04160CR		52,00	205	A1018ECR		67,20	80	A18090CR21		77,40	127
A04160CR007		47,00	205	A1018ENS		73,90	80	A18090DR21		123,90	127
A0418ACR		45,00	204	A1018FCR		70,80	80	A18090NE21		89,70	127
A0418ACR007		41,60	204	A1018FNS		77,90	80	A18090OR21		139,50	127
A0418BCR		47,50	204	A1018GCR		76,30	80	A18090WWM21		89,70	127
A0418BCR007		44,10	204	A1018GNS		84,00	80	A1809NCR		40,80	235
A0418CCR		50,20	204	A1018HCR		110,40	80	A18100AC21		57,20	122
A0418CCR007		46,50	204	A1018HNS		121,40	80	A18100BZ21		65,20	122
A04210CR		19,70	211	A1019BCR		104,00	80	A18100CG21		73,60	122
A04210CR007		18,30	211	A1019BNS		114,40	80	A18100CR21		40,80	122
A04250CR		77,00	226	A1019CCR		118,10	80	A18100DR21		65,20	122
A04270CR		67,30	222	A1019CNS		129,90	80	A18100NE21		47,00	122
A04320AL02		91,00	288	A1019FCR		109,20	81	A18100OR21		73,60	122
A0436AWW		201,40	272	A1019FNS		120,10	81	A18100WWM21		47,00	122
A0438AWW		219,90	272	A1019GCR		124,00	81	A1810DAC21		111,70	122
A04490CR		45,50	287	A1019GNS		136,30	81	A1810DBZ21		128,20	122
A04490CR007		34,00	287	A1020ACR		32,90	82	A1810DCG21		143,60	122
A0449HCR		51,10	286	A1020ANS		36,20	82	A1810DCR21		79,70	122
A0449HCR007		40,00	286	A1020BCR		62,90	82	A1810DDR21		128,20	122
A04500CR		39,00	282	A1020BNS		69,20	82	A1810DNE21		91,80	122
A04500CR007		29,30	282	A1020CCR		24,70	83	A1810DOR21		143,60	122
A04510CR		52,80	282	A1020CNS		27,10	83	A1810DWM21		91,80	122
A04510CR007		49,60	282	A1025ACR		55,40	84	A1810FAC21		89,80	123
A0451HCR		66,20	282	A1025ANS		60,90	84	A1810FBZ21		102,80	123
A0451HCR007		45,50	282	A1025BCR		55,40	84	A1810FCG21		115,50	123
A0452DWW		138,60	238	A1025BNS		60,90	84	A1810FCR21		64,10	123
A0453HCR		99,80	283	A1025CCR		71,50	85	A1810FDR21		102,80	123
A04560CR007		8,50	239	A1025CNS		78,70	85	A1810FNE21		74,10	123
A04570CR007		13,20	240	A1025DCR		55,40	84	A1810FOR21		115,50	123
A04610CR		45,60	267	A1025DNS		60,90	84	A1810FWM21		74,10	123
A0461ACR		45,60	268	A10260CR		74,70	85	A1810ZAC21		40,10	123/309
A04620CR		110,60	267	A10260NS		82,20	85	A1810ZBZ21		45,80	123/309
A0462ACR		110,60	267	A10280CR		55,40	85	A1810ZCG21		51,60	123/309
A04660CR		63,90	236	A10280NS		60,90	85	A1810ZCR21		28,60	123/309
A04660CR007		57,50	236	A1031BCR		68,30	86/286	A1810ZDR21		45,80	123/309
A0467NCR		73,70	205	A1031BNE		79,20	286	A1810ZNE21		32,80	123/309
A04680CR		105,10	233	A1031BNS		75,20	86/286	A1810ZOR21		51,60	123/309
A04690CR		183,00	233	A1051BCR		81,30	86/281	A1810ZWM21		32,80	123/309
A0470FCR		146,20	233	A1051BNE		94,30	281	A18110AC21		57,20	122
A0490CCR		72,70	262	A1051BNS		89,50	86/281	A18110BZ21		65,20	122
A0490CCR007		68,30	262	A10680CR		201,40	82	A18110CG21		73,60	122
A0490FCR		62,90	262	A10680NS		221,50	82	A18110CR21		40,80	122
A0490FCR007		57,50	262	A10950CR		79,20	86/263	A18110DR21		65,20	122
A0490TCR		48,00	262	A10950NS		87,10	86/263	A18110NE21		47,00	122
A0490TCR007		36,90	262	A1095BCR		84,50	87/263	A18110OR21		73,60	122
A0491TCR		68,30	262	A1095CCR		93,20	87/263	A18110WWM21		47,00	122
A0491TCR007		62,90	262	A12252CR003		26,50	211	A1811ZAC21		40,10	124/309
A0492TCR		110,60	266	A12253CR003		31,90	212	A1811ZBZ21		45,80	124/309
A0492TCR007		101,80	266	A12254CR003		45,50	212	A1811ZCG21		51,60	124/309
A0494ACR		47,00	204	A13010AL		71,50	230	A1811ZCR21		28,60	124/309
A0494ACR007		43,60	204	A13010NE		82,30	230	A1811ZDR21		45,80	124/309
A0494BCR		53,80	204	A1320ACR		15,80	210	A1811ZNE21		32,80	124/309
A0494BCR007		49,80	204	A1320CCR		29,00	210	A1811ZOR21		51,60	124/309
A0494CCR		63,90	204	A1331ACR		56,50	285	A1811ZWM21		32,80	124/309
A0494CCR007		58,60	204	A1351ACR		62,90	281	A18120AC21		79,20	121

Cod.	Stock	€	Pag.	Cod.	Stock	€	Pag.	Cod.	Stock	€	Pag.
A18120BZ21		90,70	121	A18190CDR		231,90	118	A18510AC		97,60	126/280
A18120CG21		101,90	121	A18190CNE		166,90	118	A18510BZ		111,70	126/280
A18120CR21		56,60	121	A18190COR		260,90	118	A18510CG		125,50	126/280
A18120DR21		90,70	121	A18190CWM		166,90	118	A18510CR		69,70	126/280
A18120NE21		65,20	121	A1820AAC		24,80	120	A18510DR		111,70	126/280
A18120OR21		101,90	121	A1820ABZ		28,20	120	A18510NE		80,80	126/280
A18120WM21		65,20	121	A1820ACG		31,90	120	A18510OR		125,50	126/280
A18122AC21		60,80	123/309	A1820ACR		17,70	120	A18510OWM		80,80	126/280
A18122BZ21		69,70	123/309	A1820ADR		28,20	120	A1851AAC		117,90	127/280
A18122CG21		78,10	123/309	A1820ANE		20,20	120	A1851ABZ		134,90	127/280
A18122CR21		43,30	123/309	A1820AOR		31,90	120	A1851ACG		151,50	127/280
A18122DR21		69,70	123/309	A1820AWM		20,20	120	A1851ACR		84,10	127/280
A18122NE21		49,90	123/309	A1820BAC		35,60	120	A1851ADR		134,90	127/280
A18122OR21		78,10	123/309	A1820BBZ		40,50	120	A1851ANE		97,30	127/280
A18122WM21		49,90	123/309	A1820BCG		45,70	120	A1851AOR		151,50	127/280
A18140AC21		116,30	128	A1820BCR		25,40	120	A1851AWM		97,30	127/280
A18140BZ21		132,60	128	A1820BDR		40,50	120	A18670AC21		91,10	121
A18140CR21		83,00	128	A1820BNE		29,20	120	A18670BZ21		104,00	121
A18140DR21		132,60	128	A1820BOR		45,70	120	A18670CG21		117,00	121
A18140OR21		149,50	128	A1820BWM		29,20	120	A18670CR21		64,90	121
A18140WM21		96,10	128	A1820CAC		50,90	121	A18670DR21		104,00	121
A1814BCG21		149,50	128	A1820CBZ		58,70	121	A18670NE21		74,80	121
A1814BNE21		96,10	128	A1820CCG		65,40	121	A18670OR21		117,00	121
A18150AC		59,80	119	A1820CCR		36,20	121	A18670WM21		74,80	121
A18150BZ		69,70	119	A1820CDR		58,70	121	A18680AC		324,90	120
A18150CG		76,80	119	A1820CNE		41,60	121	A18680BZ		371,00	120
A18150CR		42,60	119	A1820COR		65,40	121	A18680CG		417,70	120
A18150DR		69,70	119	A1820CWM		41,60	121	A18680CR		231,90	120
A18150NE		51,20	119	A18250AC		60,80	124	A18680DR		371,00	120
A18150OR		76,80	119	A18250BZ		69,70	124	A18680NE		267,20	120
A18150WM		51,20	119	A18250CG		78,10	124	A18680OR		417,70	120
A1815ACR		103,90	119	A18250CR		43,30	124	A18680WM		267,20	120
A1815BAC		55,40	119	A18250DR		69,70	124	A1895AAC		135,00	127/263
A1815BBZ		64,10	119	A18250NE		49,90	124	A1895ABZ		154,30	127/263
A1815BCG		70,40	119	A18250OR		78,10	124	A1895ACG		173,60	127/263
A1815BCR		39,10	119	A18250WM		49,90	124	A1895ACR		96,40	127/263
A1815BDR		64,10	119	A1825AAC		60,80	124	A1895ADR		154,30	127/263
A1815BNE		47,60	119	A1825ABZ		69,70	124	A1895ANE		110,90	127/263
A1815BOR		70,40	119	A1825ACG		78,10	124	A1895AOR		173,60	127/263
A1815BWM		47,60	119	A1825ACR		43,30	124	A1895AWM		110,90	127/263
A18160AC		100,70	119	A1825ADR		69,70	124	A1895BAC		144,20	127/263
A18160BZ		115,00	119	A1825ANE		49,90	124	A1895BBZ		164,80	127/263
A18160CG		129,50	119	A1825AOR		78,10	124	A1895BCG		185,40	127/263
A18160CR		71,90	119	A1825AWM		49,90	124	A1895BCR		103,00	127/263
A18160DR		115,00	119	A1825BAC		89,80	124	A1895BDR		164,80	127/263
A18160NE		83,00	119	A1825BBZ		102,80	124	A1895BNE		118,40	127/263
A18160OR		129,50	119	A1825BCG		115,50	124	A1895BOR		185,40	127/263
A18160WM		83,00	119	A1825BCR		64,10	124	A1895BWM		118,40	127/263
A1818AAC		96,20	118	A1825BDR		102,80	124	A1895CAC		154,90	127/263
A1818ABZ		110,60	118	A1825BNE		74,10	124	A1895CBZ		177,00	127/263
A1818ACG		123,70	118	A1825BOR		115,50	124	A1895CCG		199,10	127/263
A1818ACR		68,60	118	A1825BWM		74,10	124	A1895CCR		110,60	127/263
A1818ADR		110,60	118	A18260AC		79,20	125	A1895CDR		177,00	127/263
A1818ANE		79,70	118	A18260BZ		90,70	125	A1895CNE		127,30	127/263
A1818AOR		123,70	118	A18260CG		101,90	125	A1895COR		199,10	127/263
A1818AWM		79,70	118	A18260CR		56,60	125	A1895CWM		127,30	127/263
A1818BAC		116,30	118	A18260DR		90,70	125	A20010AC21		53,90	97/310
A1818BBZ		133,00	118	A18260NE		65,20	125	A20010CR21		41,40	97/310
A1818BCG		149,50	118	A18260OR		101,90	125	A20010NE21		47,70	97/310
A1818BCR		83,00	118	A18260WM		65,20	125	A20010WM21		47,70	97/310
A1818BDR		133,00	118	A1826AAC		106,80	125	A20020AC21		53,90	98/310
A1818BNE		96,10	118	A1826ABZ		122,70	125	A20020CR21		41,40	98/310
A1818BOR		149,50	118	A1826ACG		137,30	125	A20020NE21		47,70	98/310
A1818BWM		96,10	118	A1826ACR		76,30	125	A20020WM21		47,70	98/310
A1818CAC		130,10	118	A1826ADR		122,70	125	A20060AC21		86,20	98/310
A1818CBZ		149,20	118	A1826ANE		88,40	125	A20060CR21		61,30	98/310
A1818CCG		167,30	118	A1826AOR		137,30	125	A20060NE21		76,70	98/310
A1818CCR		92,90	118	A1826AWM		88,40	125	A20060WM21		76,70	98/310
A1818CDR		149,20	118	A18280AC		54,10	125	A20100AC21		67,00	97
A1818CNE		107,20	118	A18280BZ		62,10	125	A20100CR21		51,50	97
A1818COR		167,30	118	A18280CG		69,50	125	A20100NE21		59,30	97
A1818CWM		107,20	118	A18280CR		38,60	125	A20100WM21		59,30	97
A1818DAC		156,50	118	A18280DR		62,10	125	A2010ZCR03		63,90	108/308
A1818DBZ		179,00	118	A18280NE		44,30	125	A2010ZCR21		63,90	108/308
A1818DCG		201,10	118	A18280OR		69,50	125	A2010ZNE03		72,10	108/308
A1818DCR		111,70	118	A18280WM		44,30	125	A2010ZNE21		72,10	108/308
A1818DDR		179,00	118	A18310AC		85,40	126/285	A20110AC21		69,60	97
A1818DNE		129,30	118	A18310BZ		97,30	126/285	A20110CR21		53,50	97
A1818DOR		201,10	118	A18310CG		109,70	126/285	A20110NE21		61,70	97
A1818DWM		129,30	118	A18310CR		60,90	126/285	A20110WM21		61,70	97
A1819BAC		182,70	118	A18310DR		97,30	126/285	A2011ZCR03		58,60	108/308
A1819BBZ		208,70	118	A18310NE		70,80	126/285	A2011ZCR21		58,60	108/308
A1819BCG		234,80	118	A18310OR		109,70	126/285	A2011ZNE03		66,10	108/308
A1819BCR		130,30	118	A18310WM		70,80	126/285	A2011ZNE21		66,10	108/308
A1819BDR		208,70	118	A1849AAC		83,80	126/279	A20120AC21		103,10	96
A1819BNE		150,30	118	A1849ABZ		96,10	126/279	A20120CR21		79,20	96
A1819BOR		234,80	118	A1849ACG		107,70	126/279	A20120NE21		91,20	96
A1819BWM		150,30	118	A1849ACR		59,80	126/279	A20120WM21		91,20	96
A1819CAC		203,00	118	A1849ADR		96,10	126/279	A2012BAC21		121,00	96
A1819CBZ		231,90	118	A1849ANE		69,70	126/279	A2012BCR21		89,10	96
A1819CCG		260,90	118	A1849AOR		107,70	126/279	A2012BNE21		102,30	96
A1819CCR		144,90	118	A1849AWM		69,70	126/279	A2012BWM21		102,30	96

**Indice Progressivo / Progressive index**  
**Index par ordre croissant / Índice de códigos**

Cod.	Stock	€	Pag.	Cod.	Stock	€	Pag.	Cod.	Stock	€	Pag.
A2012ZCR03		79,20	108/308	A2391CCR		86,70	188	A24680CG		401,70	135
A2012ZCR21		79,20	108/308	A2391CCR007		73,70	188	A24680CR		223,00	135
A2012ZNE03		89,30	108/308	A2410AAC03		86,60	138	A24680DR		357,20	135
A2012ZNE21		89,30	108/308	A2410ABZ03		99,80	138	A24680NE		256,50	135
A20150AC		172,20	94	A2410ACG03		111,40	138	A24680OR		401,70	135
A20150CR		137,60	94	A2410ACR03		61,80	138	A24680WM		256,50	135
A20150NE		160,30	94	A2410ADR03		99,80	138	A2490AAC		56,90	134
A20150WM		160,30	94	A2410ANE03		71,50	138	A2490ABZ		65,00	134
A20160AC		115,90	94	A2410AOR03		111,40	138	A2490ACG		73,20	134
A20160CR		77,00	94	A2410AWM03		71,50	138	A2490ACR		40,60	134
A20160NE		90,00	94	A24110AC03		86,60	138	A2490ADR		65,00	134
A20160WM		90,00	94	A24110BZ03		99,80	138	A2490ANE		46,80	134
A2018AAC		94,40	94	A24110CG03		111,40	138	A2490AOR		73,20	134
A2018ACR		67,30	94	A24110CR03		61,80	138	A2490AWM		46,80	134
A2018ANE		77,60	94	A24110DR03		99,80	138	A2490BAC		62,10	134
A2018AWM		77,60	94	A24110NE03		71,50	138	A2490BBZ		71,50	134
A2018BAC		98,80	94	A24110OR03		111,40	138	A2490BCG		79,70	134
A2018BCR		70,50	94	A24110WM03		71,50	138	A2490BCR		44,20	134
A2018BNE		81,20	94	A24120AC03		109,50	137	A2490BDR		71,50	134
A2018BWM		81,20	94	A24120BZ03		125,60	137	A2490BNE		50,80	134
A2018CAC		107,80	94	A24120CG03		140,80	137	A2490BOR		79,70	134
A2018CCR		77,00	94	A24120CR03		78,10	137	A2490BWM		50,80	134
A2018CNE		88,60	94	A24120DR03		125,60	137	A2490CAC		68,40	134
A2018CWM		88,60	94	A24120NE03		90,00	137	A2490CBZ		78,10	134
A2018DAC		124,70	94	A24120OR03		140,80	137	A2490CCG		87,90	134
A2018DCR		88,90	94	A24120WM03		90,00	137	A2490CCR		48,80	134
A2018DNE		102,50	94	A2415AAC		49,10	134	A2490CDR		78,10	134
A2018DWM		102,50	94	A2415ABZ		56,50	134	A2490CNE		56,50	134
A2018MAC		97,00	95	A2415ACG		63,20	134	A2490COR		87,90	134
A2018MCR		72,80	95	A2415ACR		35,10	134	A2490CWM		56,50	134
A2018MNE		83,90	95	A2415ADR		56,50	134	A2490DAC		85,10	134
A2018MWM		83,90	95	A2415ANE		40,20	134	A2490DBZ		97,50	134
A2020AAC		35,70	95	A2415AOR		63,20	134	A2490DCG		109,30	134
A2020ACR		28,50	95	A2415AWM		40,20	134	A2490DCR		60,70	134
A2020ANE		31,50	95	A2415BAC		150,10	135	A2490DDR		97,50	134
A2020AWM		31,50	95	A2415BBZ		172,20	135	A2490DNE		70,50	134
A2020BAC		44,40	95	A2415BCG		193,00	135	A2490DOR		109,30	134
A2020BCR		35,50	95	A2415BCR		107,20	135	A2490DWM		70,50	134
A2020BNE		39,10	95	A2415BDR		172,20	135	A2491CAC		130,60	134
A2020BWM		39,10	95	A2415BNE		123,50	135	A2491CBZ		149,40	134
A2025AAC		64,50	98	A2415BOR		193,00	135	A2491CCG		167,90	134
A2025ACR		51,50	98	A2415BWM		123,50	135	A2491CCR		93,20	134
A2025ANE		58,60	98	A2416AAC		148,70	135	A2491CDR		149,40	134
A2025AWM		58,60	98	A2416ABZ		170,00	135	A2491CNE		107,20	134
A2025BAC		64,50	98	A2416ACG		191,10	135	A2491COR		167,90	134
A2025BCR		51,50	98	A2416ACR		106,10	135	A2491CWM		107,20	134
A2025BNE		58,60	98	A2416ADR		170,00	135	A30090CR26		81,30	173
A2025BWM		58,60	98	A2416ANE		122,40	135	A30100CR21		34,80	171
A20260AC		105,80	99	A2416AOR		191,10	135	A30100CR21		56,50	171
A20260CR		81,30	99	A2416AWM		122,40	135	A30110CR21		34,80	171
A20260NE		93,60	99	A24250AC		74,80	138	A30120CR21		61,80	170
A20260WM		93,60	99	A24250BZ		85,50	138	A30140CR21		61,80	173
A2028AAC		64,50	99	A24250CG		96,10	138	A30150CR		75,90	169
A2028ACR		51,50	99	A24250CR		53,30	138	A3015ACR		41,80	169
A2028ANE		58,60	99	A24250DR		85,50	138	A30160CR		44,50	169
A2028AWM		58,60	99	A24250NE		61,80	138	A3018ACR		34,80	168
A20670AC21		121,00	96	A24250OR		96,10	138	A3018BCR		56,50	168
A20670CR21		90,00	96	A24250WM		61,80	138	A3018CCR		59,70	168
A20670NE21		103,00	96	A2425CAC		105,90	139	A3018DCR		82,30	168
A20670WM21		103,00	96	A2425CBZ		120,90	139	A3018ECR		53,10	168
A23070CR01		106,10	194	A2425CCG		136,10	139	A3019CCR		109,40	168
A2307NCR003		42,40	195	A2425CCR		75,60	139	A3020ACR		26,10	170
A2308ACR01		120,30	195	A2425CDR		120,90	139	A3020BCR		26,10	170
A2308CCR01		139,70	195	A2425CNE		87,00	139	A30250CR		42,30	172
A23100CR03		32,90	190	A2425COR		136,10	139	A3025BCR		49,60	172
A2310NCR007		20,80	191	A2425CWM		87,00	139	A30260CR		53,10	172
A23110CR03		40,60	190	A24260AC		138,20	139	A30920CR		106,10	265
A23150CR		56,50	188	A24260BZ		158,10	139	A30950CR		53,60	173/264
A23150CR007		50,70	188	A24260CG		177,70	139	A32080BZ21		366,80	162
A2316TCR		35,60	189	A24260CR		98,60	139	A32080CR21		251,20	162
A2316TCR007		32,60	189	A24260DR		158,10	139	A32080DR21		408,00	162
A2317NCR003		28,00	191	A24260NE		113,80	139	A32100BZ07		154,90	160
A23210CR		23,90	189/209	A24260OR		177,70	139	A32100CR21		107,20	160
A23210CR007		22,00	189/209	A24260WM		113,80	139	A32100DR21		171,00	160
A23240CR		241,50	198/296	A2426BAC		93,40	139	A32110BZ07		151,60	160
A23250CR		39,80	193	A2426BBZ		106,70	139	A32110CR21		102,90	160
A23250CR007		36,30	193	A2426BCG		120,00	139	A32110DR21		167,80	160
A23260CR		42,70	193	A2426BCR		66,70	139	A32120BZ21		172,20	159
A23260CR003		32,80	193	A2426BDR		106,70	139	A32120CR21		121,40	159
A23270CR		57,50	193	A2426BNE		82,50	139	A32120DR21		184,00	159
A23270CR007		50,90	193	A2426BOR		120,00	139	A32150BZ		217,70	158
A23280CR		37,00	194	A2426BWM		82,50	139	A32150CR		133,20	158
A23280CR007		34,30	194	A24280AC		55,40	140	A32150DR		242,50	158
A2367ACR21		85,50	189	A24280BZ		63,90	140	A32160BZ		166,80	158
A2390ACR		40,60	188	A24280CG		71,20	140	A32160CR		91,00	158
A2390ACR007		37,40	188	A24280CR		39,50	140	A32160DR		184,00	158
A2390BCR		44,80	188	A24280DR		63,90	140	A3218ABZ		254,40	158
A2390BCR007		41,10	188	A24280NE		45,50	140	A3218ACR		144,00	158
A2390CCR		49,00	188	A24280OR		71,20	140	A3218ADR		282,60	158
A2390CCR007		45,20	188	A24280WM		45,50	140	A3218BBZ		263,10	158
A2390DCR		58,60	188	A24680AC		312,40	135	A3218BCR		148,40	158
A2391BCR		81,30	188	A24680BZ		357,20	135	A3218BDR		291,10	158

Cod.	Stock	€	Pag.	Cod.	Stock	€	Pag.	Cod.	Stock	€	Pag.
A3218CBZ		269,50	158	A4626BCR		93,20	152	A7178DNE21		-	44
A3218CCR		153,80	158	A46280CR		72,70	152	A71950AC		-	47
A3218CDR		300,90	158	A46510CR		164,60	153/280	A71950CR		-	47
A32200BZ		150,50	159	A46670CR21		153,80	149	A71950NE		-	47
A32200CR		86,70	159	A4667ZCR21		125,60	150/311	A8028DAL		82,30	221
A32200DR		166,80	159	A4690MCR		105,10	153/265	A8029DAL		139,70	222
A32240CR		242,50	163	A7110DAC04		-	45	A8035AAQ		878,40	32
A32250BZ		138,60	160	A7110DAC21		-	45	A8035AAX		878,40	32
A32250CR		75,90	160	A7110DCR04		-	45	A8035ABN		878,40	32
A32250DR		154,90	160	A7110DCR21		-	45	A8035ABX		878,40	32
A32260BZ		174,40	161	A7110DNE04		-	45	A8035ACE		878,40	32
A32260CR		100,80	161	A7110DNE21		-	45	A8035ACX		878,40	32
A32260DR		193,80	161	A7110FAC04		-	44	A8035AGD		878,40	32
A3226ABZ		226,20	161	A7110FAC21		-	44	A8035AMP		878,40	32
A3226ACR		127,80	161	A7110FCR04		-	44	A8035ANX		878,40	32
A3226ADR		253,30	161	A7110FCR21		-	44	A8035ATL		878,40	32
A32500BZ		205,60	161/281	A7110FNE04		-	44	A8035BAQ		996,30	33
A32500CR		125,60	161/281	A7110FNE21		-	44	A8035BAX		996,30	33
A32500DR		229,50	161/281	A7110WAC04		-	45	A8035BBN		996,30	33
A32680BZ		337,80	159	A7110WAC21		-	45	A8035BBX		996,30	33
A32680CR		192,70	159	A7110WCR04		-	45	A8035BCE		996,30	33
A32680DR		374,50	159	A7110WCR21		-	45	A8035BCX		996,30	33
A32850BZ		656,90	162/296	A7110WNE04		-	45	A8035BGD		996,30	33
A32850CR		377,60	162/296	A7110WNE21		-	45	A8035BMP		996,30	33
A32850DR		729,40	162/296	A7110ZAC04		-	45	A8035BNX		996,30	33
A32920BZ		251,20	162/266	A7110ZAC21		-	45	A8035BTL		996,30	33
A32920CR		175,50	162/266	A7110ZCR04		-	45	A8035CAQ		589,20	33
A32920DR		278,10	162/266	A7110ZCR21		-	45	A8035CAX		589,20	33
A33850CR		492,40	110/292	A7110ZNE04		-	45	A8035CBN		589,20	33
A33850NE		539,40	110/292	A7110ZNE21		-	45	A8035CBX		589,20	33
A3395JCR		208,90	206	A71150AC		-	42	A8035CCE		589,20	33
A3395KCR		161,30	206	A71150CR		-	42	A8035CCX		589,20	33
A36090CR26		68,30	184	A71150NE		-	42	A8035CGD		589,20	33
A36100CR21		28,10	181	A7115AAC		-	42	A8035CMP		589,20	33
A3610DCR21		47,80	181	A7115ACR		-	42	A8035CNX		589,20	33
A36110CR21		28,10	182	A7115ANE		-	42	A8035CTL		589,20	33
A36120CR21		51,70	181	A71180AC		-	43	A8036AAQ		1.098,00	36
A36140CR21		51,70	184	A71180CR		-	43	A8036AAQ		1.098,00	36
A36150CR		65,00	179	A71180NE		-	43	A8036ABN		1.098,00	36
A36160CR		35,80	180	A7118AAC		-	42	A8036ABX		1.098,00	36
A3618ACR		28,10	178	A7118ACR		-	42	A8036ACE		1.098,00	36
A3618BCR		46,20	178	A7118ANE		-	42	A8036ACX		1.098,00	36
A3618CCR		49,60	178	A7118BAC		-	42	A8036AGD		1.098,00	36
A3618DCR		75,90	178	A7118BCR		-	42	A8036AMP		1.098,00	36
A3618ECR		41,80	178	A7118BNE		-	42	A8036ANX		1.098,00	36
A3619CCR		91,00	179	A7118CAC		-	42	A8036ATL		1.098,00	36
A3620ACR		19,60	180	A7118CCR		-	42	A8036BAQ		1.244,80	36
A3620BCR		21,20	180	A7118CNE		-	42	A8036BAX		1.244,80	36
A36250CR		35,10	182	A7118DAC		-	42	A8036BBN		1.244,80	36
A3625BCR		43,70	182	A7118DCR		-	42	A8036BBX		1.244,80	36
A36260CR		45,20	183	A7118DNE		-	42	A8036BCE		1.244,80	36
A3690ACR		48,70	179	A7120AAC		-	43	A8036BCX		1.244,80	36
A3690BCR		55,40	179	A7120ACR		-	43	A8036BGD		1.244,80	36
A3690CCR		62,90	179	A7120ANE		-	43	A8036BMP		1.244,80	36
A36920CR		87,80	183/266	A7120BAC		-	43	A8036BNX		1.244,80	36
A36950CR		50,50	183/265	A7120BCR		-	43	A8036BTL		1.244,80	36
A37140BZ		189,50	163	A7120BNE		-	43	A8036CAQ		736,00	36
A37140CR		105,10	163	A71250AC		-	46	A8036CAX		736,00	36
A37140DR		208,90	163	A71250CR		-	46	A8036CBN		736,00	36
A3814ACR		97,50	224	A71250NE		-	46	A8036CBX		736,00	36
A3814ACR007		88,90	224	A7125BAC		-	46	A8036CCE		736,00	36
A38210CR		30,30	209	A7125BCR		-	46	A8036CCX		736,00	36
A38210CR007		26,70	209	A7125BNE		-	46	A8036CGD		736,00	36
A38240CR		68,30	212	A71260AC		-	46	A8036CMP		736,00	36
A38240CR007		60,70	212	A71260CR		-	46	A8036CNX		736,00	36
A38250CR		58,60	222	A71260NE		-	46	A8036CTL		736,00	36
A38250CR007		50,50	222	A71280AC		-	47	A8037AAQ		1.156,90	37
A3827ACR		66,20	220	A71280CR		-	47	A8037AAX		1.156,90	37
A3827ACR007		57,50	220	A71280NE		-	47	A8037ABN		1.156,90	37
A46080CR21		206,90	153	A7178AAC04		-	44	A8037ABX		1.156,90	37
A46100CR21		106,10	149	A7178AAC21		-	44	A8037ACE		1.156,90	37
A4610ZCR21		99,80	151/311	A7178ACR04		-	44	A8037ACX		1.156,90	37
A46110CR21		106,10	150	A7178ACR21		-	44	A8037AGD		1.156,90	37
A4611MCR		86,70	150	A7178ANE04		-	44	A8037AMP		1.156,90	37
A4611ZCR21		101,80	151/311	A7178ANE21		-	44	A8037ANX		1.156,90	37
A46150CR		170,00	148	A7178BAC04		-	44	A8037ATL		1.156,90	37
A46160CR		91,00	148	A7178BAC21		-	44	A8037BAQ		1.312,30	37
A4618ACR		106,10	146	A7178BCR04		-	44	A8037BAX		1.312,30	37
A4618BCR		117,00	146	A7178BCR21		-	44	A8037BBN		1.312,30	37
A4618CCR		126,70	146	A7178BNE04		-	44	A8037BBX		1.312,30	37
A4618ECR		106,10	146	A7178BNE21		-	44	A8037BCE		1.312,30	37
A4618FCR		117,00	146	A7178CAC04		-	44	A8037BCX		1.312,30	37
A4618GCR		126,70	146	A7178CAC21		-	44	A8037BGD		1.312,30	37
A4618JCR		125,60	147/206	A7178CCR04		-	44	A8037BMP		1.312,30	37
A4618KCR		85,50	147/207	A7178CCR21		-	44	A8037BNX		1.312,30	37
A4618LCR		136,40	146	A7178CNE04		-	44	A8037BTL		1.312,30	37
A4618UCR		128,90	147	A7178CNE21		-	44	A8037CAQ		773,50	38
A46200CR		44,00	148	A7178DAC04		-	44	A8037CAX		773,50	38
A46210CR		58,60	149	A7178DAC21		-	44	A8037CBN		773,50	38
A46250CR		78,10	151	A7178DCR04		-	44	A8037CBX		773,50	38
A46252CR		133,20	152	A7178DCR21		-	44	A8037CCE		773,50	38
A4625ACR		78,10	151	A7178DNE04		-	44	A8037CCX		773,50	38

**Indice Progressivo / Progressive index**  
**Index par ordre croissant / Índice de códigos**

Cod.	Stock	€	Pag.	Cod.	Stock	€	Pag.	Cod.	Stock	€	Pag.
A8037CGD		773,50	38	A8086ANX		696,30	34	A8809RHW		96,50	56
A8037CMP		773,50	38	A8086ATL		696,30	34	A8809RLA		96,50	56
A8037CNX		773,50	38	A8086CAQ		789,50	35	A8809RLD		96,50	56
A8037CTL		773,50	38	A8086CAX		789,50	35	A8809RLG		96,50	56
A8038AAQ		1.156,90	38	A8086CBN		789,50	35	A8809RLJ		96,50	56
A8038AAX		1.156,90	38	A8086CBX		789,50	35	A8809RLM		96,50	56
A8038ABN		1.156,90	38	A8086CCE		789,50	35	A8809RNE		70,80	56
A8038ABX		1.156,90	38	A8086CCX		789,50	35	A8809RNS		64,30	56
A8038ACE		1.156,90	38	A8086CGD		789,50	35	A8809RTB		96,50	56
A8038ACX		1.156,90	38	A8086CMP		789,50	35	A8809RTF		96,50	56
A8038AGD		1.156,90	38	A8086CNX		789,50	35	A8809RTJ		96,50	56
A8038AMP		1.156,90	38	A8086CTL		789,50	35	A8809RWM		70,80	56
A8038ANX		1.156,90	38	A8801MNE		141,50	56	A8809SHA		101,80	55
A8038ATL		1.156,90	38	A8801MNS		128,60	56	A8809SHB		112,50	55
A8038BAQ		1.312,30	38	A8801MWM		141,50	56	A8809SHC		112,50	55
A8038BAX		1.312,30	38	A8809MHA		78,30	56	A8809SHD		101,80	55
A8038BBN		1.312,30	38	A8809MHD		78,30	56	A8809SHE		112,50	55
A8038BBX		1.312,30	38	A8809MHG		78,30	56	A8809SHF		112,50	55
A8038BCE		1.312,30	38	A8809MHJ		78,30	56	A8809SHG		101,80	55
A8038BCX		1.312,30	38	A8809MHM		78,30	56	A8809SHH		112,50	55
A8038BGD		1.312,30	38	A8809MHQ		78,30	56	A8809SHI		112,50	55
A8038BMP		1.312,30	38	A8809MHT		78,30	56	A8809SHJ		101,80	55
A8038BNX		1.312,30	38	A8809MHW		78,30	56	A8809SHK		112,50	55
A8038BTL		1.312,30	38	A8809MLA		78,30	56	A8809SHL		112,50	55
A80750AQ		482,10	30	A8809MLD		78,30	56	A8809SHM		101,80	55
A80750AX		482,10	30	A8809MLG		78,30	56	A8809SHN		112,50	55
A80750BN		482,10	30	A8809MLJ		78,30	56	A8809SHP		112,50	55
A80750BX		482,10	30	A8809MLM		78,30	56	A8809SHQ		101,80	55
A80750CE		482,10	30	A8809MNE		47,20	56	A8809SHR		112,50	55
A80750CX		482,10	30	A8809MNS		42,90	56	A8809SHS		112,50	55
A80750GD		482,10	30	A8809MTB		78,30	56	A8809SHT		101,80	55
A80750MP		482,10	30	A8809MTF		78,30	56	A8809SHU		112,50	55
A80750NX		482,10	30	A8809MTJ		78,30	56	A8809SHV		112,50	55
A80750TL		482,10	30	A8809MWM		47,20	56	A8809SHW		101,80	55
A80760AQ		602,10	34	A8809NHA		75,00	55	A8809SHX		112,50	55
A80760AX		602,10	34	A8809NHB		82,60	55	A8809SHY		112,50	55
A80760BN		602,10	34	A8809NHC		82,60	55	A8809SLA		101,80	55
A80760BX		602,10	34	A8809NHD		75,00	55	A8809SLB		112,50	55
A80760CE		602,10	34	A8809NHE		82,60	55	A8809SLC		112,50	55
A80760CX		602,10	34	A8809NHF		82,60	55	A8809SLD		101,80	55
A80760GD		602,10	34	A8809NHG		75,00	55	A8809SLE		112,50	55
A80760MP		602,10	34	A8809NHH		82,60	55	A8809SLF		112,50	55
A80760NX		602,10	34	A8809NHI		82,60	55	A8809SLG		101,80	55
A80760TL		602,10	34	A8809NHJ		75,00	55	A8809SLH		112,50	55
A8085AAQ		557,10	30	A8809NHK		82,60	55	A8809SLI		112,50	55
A8085AAX		557,10	30	A8809NHL		82,60	55	A8809SLJ		101,80	55
A8085ABN		557,10	30	A8809NHM		75,00	55	A8809SLK		112,50	55
A8085ABX		557,10	30	A8809NHN		82,60	55	A8809SLL		112,50	55
A8085ACE		557,10	30	A8809NHP		82,60	55	A8809SLM		101,80	55
A8085ACX		557,10	30	A8809NHQ		75,00	55	A8809SLN		112,50	55
A8085AGD		557,10	30	A8809NHR		82,60	55	A8809SLR		112,50	55
A8085AMP		557,10	30	A8809NHS		82,60	55	A8809SNE		70,80	55
A8085ANX		557,10	30	A8809NHT		75,00	55	A8809SNS		64,30	55
A8085ATL		557,10	30	A8809NHU		82,60	55	A8809STB		101,80	55
A8085BAQ		589,20	31	A8809NHV		82,60	55	A8809STC		112,50	55
A8085BAX		589,20	31	A8809NHW		75,00	55	A8809STD		112,50	55
A8085BBN		589,20	31	A8809NHX		82,60	55	A8809STF		101,80	55
A8085BBX		589,20	31	A8809NHY		82,60	55	A8809STG		112,50	55
A8085BCE		589,20	31	A8809NLA		75,00	55	A8809STH		112,50	55
A8085BCX		589,20	31	A8809NLB		82,60	55	A8809STJ		101,80	55
A8085BGD		589,20	31	A8809NLC		82,60	55	A8809STK		112,50	55
A8085BMP		589,20	31	A8809NLD		75,00	55	A8809STP		112,50	55
A8085BNX		589,20	31	A8809NLE		82,60	55	A8809SWM		70,80	55
A8085BTL		589,20	31	A8809NLF		82,60	55	A88100CR21		59,00	71
A8085CAQ		632,10	31	A8809NLG		75,00	55	A88100NE21		68,70	59
A8085CAX		632,10	31	A8809NLH		82,60	55	A88100NS21		62,70	59
A8085CBN		632,10	31	A8809NLI		82,60	55	A88100WM21		68,70	59
A8085CBX		632,10	31	A8809NLJ		75,00	55	A8810MNE21		80,40	54
A8085CCE		632,10	31	A8809NLK		82,60	55	A8810MNS21		73,00	54
A8085CCX		632,10	31	A8809NLL		82,60	55	A8810MWM21		80,40	54
A8085CGD		632,10	31	A8809NLM		75,00	55	A8810NNE21		73,00	54
A8085CMP		632,10	31	A8809NLN		82,60	55	A8810NS21		67,00	54
A8085CNX		632,10	31	A8809NLR		82,60	55	A8810NWM21		73,00	54
A8085CTL		632,10	31	A8809NNE		47,20	55	A88110CR21		59,00	71
A8085DAQ		664,20	32	A8809NNS		42,90	55	A88110NE21		68,70	59
A8085DAX		664,20	32	A8809NTB		75,00	55	A88110NS21		62,70	59
A8085DBN		664,20	32	A8809NTC		82,60	55	A88110WM21		68,70	59
A8085DBX		664,20	32	A8809NTD		82,60	55	A88120CR21		80,40	70
A8085DCE		664,20	32	A8809NTF		75,00	55	A88120NE21		94,00	59
A8085DCX		664,20	32	A8809NTG		82,60	55	A88120NS21		85,90	59
A8085DGD		664,20	32	A8809NTH		82,60	55	A88120WM21		94,00	59
A8085DMP		664,20	32	A8809NTJ		75,00	55	A8812MNE21		100,80	53
A8085DNX		664,20	32	A8809NTK		82,60	55	A8812MNS21		91,10	53
A8085DTL		664,20	32	A8809NTP		82,60	55	A8812MWM21		100,80	53
A8086AAQ		696,30	34	A8809NWM		47,20	55	A8814MNE		153,30	57
A8086AAX		696,30	34	A8809RHA		96,50	56	A8814MNS		139,30	57
A8086ABN		696,30	34	A8809RHG		96,50	56	A8814MWM		153,30	57
A8086ABX		696,30	34	A8809RHH		96,50	56	A88150CR		55,60	68
A8086ACE		696,30	34	A8809RHJ		96,50	56	A88150NE		63,70	57
A8086ACX		696,30	34	A8809RHM		96,50	56	A88150NS		58,60	57
A8086AGD		696,30	34	A8809RHQ		96,50	56	A88150WM		63,70	57
A8086AMP		696,30	34	A8809RHT		96,50	56	A8818BCR		75,00	68

Cod.	Stock	€	Pag.	Cod.	Stock	€	Pag.	Cod.	Stock	€	Pag.
A8818BNE		89,00	57	A8826NHG		107,20	54	A8883GNS		203,60	52
A8818BNS		80,40	57	A8826NHJ		117,90	54	A8883GWM		224,00	52
A8818BWM		89,00	57	A8826NHI		117,90	54	A8883HNE		259,30	52
A8818CCR		87,90	68	A8826NHJ		107,20	54	A8883HNS		235,70	52
A8818CNE		100,80	57	A8826NHK		117,90	54	A8883HWM		259,30	52
A8818CNS		91,10	57	A8826NHL		117,90	54	A8883INE		294,60	52
A8818CWM		100,80	57	A8826NHM		107,20	54	A8883INS		267,80	52
A8818DCR		99,80	68	A8826NHN		117,90	54	A8883IWM		294,60	52
A8818DNE		112,50	57	A8826NHP		117,90	54	A8883JNE		330,10	52
A8818DNS		101,80	57	A8826NHQ		107,20	54	A8883JNS		300,00	52
A8818DWM		112,50	57	A8826NHR		117,90	54	A8883JWM		330,10	52
A8818MNE		53,10	53	A8826NHS		117,90	54	A8883KNE		365,40	52
A8818MNS		48,30	53	A8826NHT		107,20	54	A8883KNS		332,10	52
A8818MWM		53,10	53	A8826NHU		117,90	54	A8883KWM		365,40	52
A8818NNE		65,50	53	A8826NHV		117,90	54	A8883LNE		400,70	52
A8818NNS		59,00	53	A8826NHW		107,20	54	A8883LNS		364,30	52
A8818NWM		65,50	53	A8826NHX		117,90	54	A8883LWM		400,70	52
A8818RNE		82,60	53	A8826NHY		117,90	54	A8883MNE		123,20	52
A8818RNS		75,00	53	A8826NLA		107,20	54	A8883MNS		107,20	52
A8818RWM		82,60	53	A8826NLB		117,90	54	A8883MWM		123,20	52
A8818SNE		100,80	53	A8826NLC		117,90	54	A8883NNE		144,70	52
A8818SNS		91,10	53	A8826NLD		107,20	54	A8883NNS		128,60	52
A8818SWM		100,80	53	A8826NLE		117,90	54	A8883NWM		144,70	52
A8820ACR		23,60	69	A8826NLF		117,90	54	A8883ONE		171,40	52
A8820ANE		30,10	58	A8826NLG		107,20	54	A8883ONS		150,00	52
A8820ANS		26,80	58	A8826NLH		117,90	54	A8883OWM		171,40	52
A8820AWM		30,10	58	A8826NLI		117,90	54	A8883PNE		203,60	52
A88250CR		51,50	72	A8826NLJ		107,20	54	A8883PNS		171,40	52
A88250NE		59,00	60	A8826NLK		117,90	54	A8883PWM		203,60	52
A88250NS		53,60	60	A8826NLL		117,90	54	A8883QNE		225,00	52
A88250WWM		59,00	60	A8826NLM		107,20	54	A8883QNS		192,90	52
A8825ACR		51,50	72	A8826NLN		117,90	54	A8883QWM		225,00	52
A8825ANE		59,00	60	A8826NLR		117,90	54	A8883RNE		262,50	52
A8825ANS		53,60	60	A8826NNE		82,60	54	A8883RNS		225,00	52
A8825AWM		59,00	60	A8826NNS		75,00	54	A8883RWM		262,50	52
A8826MHA		107,20	54	A8826NTB		107,20	54	A88K20CR21		210,00	69
A8826MHB		117,90	54	A8826NTC		117,90	54	A88K30CR21		205,00	69
A8826MHC		117,90	54	A8826NTD		117,90	54	A88K40CR21		260,00	70
A8826MHD		107,20	54	A8826NTF		107,20	54	A88K5ACR		130,00	71
A8826MHE		117,90	54	A8826NTG		117,90	54	A88K5BCR		130,00	71
A8826MHF		117,90	54	A8826NTH		117,90	54	AH925XCR		110,60	259
A8826MHG		107,20	54	A8826NTJ		107,20	54	AH992ACR		230,70	254
A8826MHH		117,90	54	A8826NTK		117,90	54	AH992ACU		230,70	254
A8826MHI		117,90	54	A8826NTP		117,90	54	AH993ACR		338,80	255
A8826MHJ		107,20	54	A8826NWM		82,60	54	AH993ACU		338,80	255
A8826MHK		117,90	54	A88280CR		60,60	72	AH993BCR		338,80	256
A8826MHL		117,90	54	A88280NE		69,70	60	AH993BCU		338,80	256
A8826MHM		107,20	54	A88280NS		63,70	60	AH993CCR		362,60	256
A8826MHN		117,90	54	A88280WWM		69,70	60	AH993CCU		362,60	256
A8826MHP		117,90	54	A8842MNE		41,40	56	AH993DCR		362,60	256
A8826MHQ		107,20	54	A8842MNS		37,50	56	AH993DCU		362,60	256
A8826MHR		117,90	54	A8842MWM		41,40	56	AH994ACR		399,40	257
A8826MHS		117,90	54	A8851OCR		75,00	72	AH994ACU		399,40	257
A8826MHT		107,20	54	A8851ONE		82,60	60	AH994BCR		399,40	257
A8826MHU		117,90	54	A8851ONS		75,00	60	AH994BCU		399,40	257
A8826MHV		117,90	54	A8851OWM		82,60	60	AH994CCR		405,90	257
A8826MHW		107,20	54	A8851MNE		47,20	55	AH994CCU		405,90	257
A8826MHX		117,90	54	A8851MNS		42,90	55	AH994DCR		405,90	258
A8826MHY		117,90	54	A8851MWM		47,20	55	AH994DCU		405,90	258
A8826MLA		107,20	54	A8851NNE		47,20	55	AH995ACR		189,50	254
A8826MLB		117,90	54	A8851NNS		42,90	55	AH995ACU		189,50	254
A8826MLC		117,90	54	A8851NWM		47,20	55	AH995BCR		204,60	254
A8826MLD		107,20	54	A88670CR21		91,10	70	AH995BCU		204,60	254
A8826MLE		117,90	54	A88670NE21		105,10	58	AH995CCR		309,60	254
A8826MLF		117,90	54	A88670NS21		96,00	58	AH995CCU		309,60	254
A8826MLG		107,20	54	A88670WM21		105,10	58	AH995FCR		364,80	254
A8826MLH		117,90	54	A8867MNE21		106,10	53	AH995FCU		364,80	254
A8826MLI		117,90	54	A8867MNS21		96,50	53	AH996ACR		334,40	255
A8826MLJ		107,20	54	A8867MWM21		106,10	53	AH996ACU		334,40	255
A8826MLK		117,90	54	A88680CR		150,00	68	AH996BCR		334,40	255
A8826MLL		117,90	54	A88680NE		176,80	58	AH996BCU		334,40	255
A8826MLM		107,20	54	A88680NS		160,70	58	AH997ACR		616,80	258
A8826MLN		117,90	54	A88680WWM		176,80	58	AH997CCR		873,30	258
A8826MLR		117,90	54	A8883ANE		53,60	52	AH9K1ACR		145,20	259
A8826MNE		82,60	54	A8883ANS		48,30	52	A00010AL		32,20	313
A8826MNS		75,00	54	A8883AWM		53,60	52	A00020AL		34,70	313
A8826MTB		107,20	54	A8883BNE		65,50	52	A00060AL		53,60	312
A8826MTC		117,90	54	A8883BNS		59,00	52	AV014AAS		116,90	15/87
A8826MTD		117,90	54	A8883BWM		65,50	52	AV014ABZ		161,90	15/141
A8826MTF		107,20	54	A8883CNE		77,20	52	AV014ACR		100,80	15/87/99/141/ 154/197
A8826MTG		117,90	54	A8883CNS		69,70	52	AV014ACR007		90,10	223
A8826MTH		117,90	54	A8883CWM		77,20	52	AV014ACR01Y		154,00	6
A8826MTJ		107,20	54	A8883DNE		94,40	52	AV014ACR02Y		154,00	6
A8826MTK		117,90	54	A8883DNS		85,70	52	AV014ACR03Y		154,00	6
A8826MTP		117,90	54	A8883DWM		94,40	52	AV014ACS		181,10	15
A8826MWM		82,60	54	A8883ENE		117,90	52	AV014ADR		196,20	15/141
A8826NHA		107,20	54	A8883ENS		107,20	52	AV014AGE		181,10	15
A8826NHB		117,90	54	A8883EWM		117,90	52	AV014AOR		161,90	15/141
A8826NHC		117,90	54	A8883FNE		141,50	52	AV014AWM		100,80	15/99/141
A8826NHD		107,20	54	A8883FNS		128,60	52	AV014AWM05Y		154,00	7
A8826NHE		117,90	54	A8883FWM		141,50	52	AV014AWM06Y		154,00	7
A8826NHF		117,90	54	A8883GNE		224,00	52				

**Indice Progressivo / Progressive index**  
**Index par ordre croissant / Índice de códigos**

Cod.	Stock	€	Pag.
AV014AWM07Y		154,00	8
AV014AWM08Y		154,00	8
AV014AWM09Y		154,00	8
AV014AWY		100,80	15
AV014AWZ		100,80	15
AV014BAC		116,90	15/100/141
AV014BCG		116,90	15/141
AV014BCO		181,10	15
AV014BCR		100,80	15/100/141/154/197
AV014BCR007		90,10	223
AV014BCR04Y		154,00	7
AV014BML		181,10	15
AV014BNC		100,80	15
AV014BNE		100,80	15/100/141
AV014BNE10Y		154,00	9
AV014BNE11Y		154,00	9
AV014BNE12Y		154,00	9
AV014BRM		181,10	15
AV0310CR		133,20	287
AV031ACR		80,20	286
AV0320CR		205,60	288
AV032ACR		172,20	287
AV0330CR		215,40	283
AV033ACR		213,30	288
AV033BCR		213,30	289
AV036BNE		252,30	273
AV036BWZ		238,10	273
AV0420AL		36,30	228
AV0420AL007		33,50	228
AV042ACR		18,00	228
AV042ANE		20,60	228
AV054YSN		180,80	237
AV058CCR		153,30	250
AV058ECR		106,10	250
AV058ENE		141,50	250
AV058FCR		117,90	249
AV058LCR		151,20	251
AV058MCR		162,90	249
AV058PCR		162,70	251
AV058PNE		176,80	251
AV058QCR		172,60	250
AV058XCR		188,60	248
AV058YCR		200,40	249
AV0710CR		45,40	227/313
AV0710NE		52,20	227
AV071ZCR		48,50	227
AV071ZNE		56,50	227
AV085CNE		173,90	292
AV085CWM		173,90	292
AV085DCR		211,10	294
AV085FCR		260,90	294
AV086DCR		233,90	295
AV086ECR		272,80	295
AV0VNO		42,70	302
AV1010AL		37,00	312
AV1060CR		66,00	312
AV1120CR		67,30	214
AV1120NE		78,10	214
AV112ACR		36,10	214
AV114AAS		211,10	19/61/100
AV114ACR		177,90	19/73/100/110
AV114AWM		211,10	19/61/100
AV114BCR		177,90	19/73/100/111
AV114BNE		211,10	19/61/100/111
AV120AAC		34,50	136/207
AV120ABZ		39,10	136/207
AV120ACG		44,30	136/207
AV120ACR		24,60	136/207
AV120ADR		39,10	136/207
AV120ANE		28,20	136/207
AV120AOR		44,30	136/207
AV120AWM		28,20	136/207
AV120BAC		46,30	136/208
AV120BBZ		56,50	136/208
AV120BCG		59,50	136/208
AV120BCR		33,00	136/208
AV120BDR		56,50	136/208
AV120BNE		38,00	136/208
AV120BOR		59,50	136/208
AV120BWM		38,00	136/208
AV120CAC		79,10	137/208
AV120CBZ		93,20	137/208
AV120CCG		101,80	137/208
AV120CCR		56,50	137/208
AV120CDR		93,20	137/208
AV120CNE		65,00	137/208
AV120COR		101,80	137/208
AV120CWM		65,00	137/208
AV120DAC		113,90	137/208
AV120DBG		129,90	137/208
AV120DCG		146,40	137/208
AV120DCR		81,30	137/208

Cod.	Stock	€	Pag.
AV120DDR		129,90	137/208
AV120DNE		94,30	137/208
AV120DOR		146,40	137/208
AV120DWM		94,30	137/208
AV120EAC		77,80	136/207
AV120EBZ		88,90	136/207
AV120ECG		100,00	136/207
AV120ECR		55,60	136/207
AV120EDR		88,90	136/207
AV120ENE		64,00	136/207
AV120EOR		100,00	136/207
AV120EWM		64,00	136/207
AV131DCR		78,10	285
AV131ECR		85,50	284
AV131FAL		87,80	284
AV151DCR		81,30	279
AV151ECR		87,80	279
AV151FAL		106,10	278
AV154ANW		146,50	238
AV154AWW		146,50	238
AV154CWM		69,70	238
AV1580CR		242,00	248
AV158CCR		289,30	248
AV190AAC		55,40	204
AV190ABZ		69,40	204
AV190ACG		58,60	204
AV190ACR		42,80	204
AV190ADR		62,90	204
AV190ANE		49,40	204
AV190AOR		69,40	204
AV190AWM		49,40	204
AV190BAC		62,90	204
AV190BBZ		78,10	204
AV190BCG		66,20	204
AV190BCR		48,50	204
AV190BDR		71,50	204
AV190BNE		56,50	204
AV190BOR		78,10	204
AV190BWM		56,50	204
AV190CAC		66,20	204
AV190CBZ		82,30	204
AV190CCG		69,40	204
AV190CCR		51,40	204
AV190CDR		75,90	204
AV190CNE		59,70	204
AV190COR		82,30	204
AV190CWM		59,70	204
AV231AAL08		82,60	284
AV231AAL13		82,60	284
AV231ANE08		95,00	284
AV231ANS08		90,80	284
AV231ANS13		90,80	284
AV231AWM13		95,00	284
AV231CCR		70,80	283
AV231CNE		79,10	283
AV251AAL08		88,40	278
AV251AAL13		88,40	278
AV251ANE08		100,00	278
AV251ANS08		96,80	278
AV251ANS13		96,80	278
AV251AWM13		100,00	278
AV251CCR		76,70	278
AV251CNE		86,20	278
AV258ACR		330,10	246
AV258ANE		365,40	246
AV258BCR		353,50	246
AV258CCR		377,10	247
AV258CNE		412,50	247
AV258DCR		400,70	247
AV258PCR		306,50	246
AV258QCR		353,50	247
AV375ANE		252,30	273
AV375AWW		238,10	273
AV375BNE		304,20	273
AV375BWW		291,10	273
AV4010AL		73,70	229
AV401DAL		192,70	229
AV401DNE		221,90	229
AV4023AL		53,50	230
AV4023NE		61,80	230
AV4025AL		71,50	231
AV4025NE		82,30	231
AV402AAL		44,10	230
AV402BAL		58,60	231
AV408ACR01		98,60	234
AV408CCR01		122,40	234
AV414AAL		81,40	23/197/224
AV414ANS		87,30	23/224
AV414BNE		87,30	23/224
AV420ACR007		17,50	210
AV425ACR		62,90	219
AV425ANE		72,70	219

Cod.	Stock	€	Pag.
AV425BCR		93,20	220
AV426DCR		70,50	220
AV426ECR		111,60	221
AV426FCR		68,30	221
AV427GAL		125,60	223
AV427GNE		145,20	223
AV4284CR		44,40	194
AV4290AL		264,50	228
AV4290NE		305,30	228
AV454CWM		200,30	237
AV454DWM		241,50	237
AV4670AL		128,90	215
AV467ANW		40,60	215
AV467AWW		40,60	215
AV467BAL		306,40	215
AV467CAL		306,40	216
AV467DAL		306,40	216
AV467EWW		107,20	216
AV467XWW		139,30	217
AV473BNS		555,50	239
AV474ASL		194,80	239
AV567ACR		135,40	213
AV602AAL001		31,40	231
AV602ANS		35,50	231
AV602BAL001		37,30	232
AV602BNS		44,90	232
AV602SAL		71,50	232
AV8140WZ		43,80	225
AV8140WZ007		39,50	225
R0000K		15,10	178
R00100		20,20	321
R00100007		18,00	320
R01060001		24,40	325
R01060002		25,60	325
R01060003		30,20	325
R01060004		30,20	326
R01060005		31,40	326
R01100		5,40	192/219/322
R01110		5,40	192/318
R01500		2,10	337
R01500002		3,90	338
R03110		20,10	191/219/318
R03290		2,90	327
R03290001		15,70	327
R03600		12,80	192/218/321
R0407A001		35,60	326
R04310		9,00	337
R05140		8,70	334
R05300		40,00	337
R07140		29,00	329
R10000A		9,10	87
R11260		42,40	336
R11260001		47,40	336
R11320001		68,30	335
R11509		-	235
R1150A		43,60	195/236/335
R11700002		53,00	336
R13000001		2,00	340
R13140001		7,60	332
R1314B001		7,60	332
R14680		102,90	335
R1510B001		35,70	319
R1510B002		35,70	319
R1511B001		29,90	316
R1511B002		29,90	316
R1512B		29,00	322
R1512B004		29,00	323
R1800N001		15,10	118
R1800N002		24,00	118
R1800N004		27,20	118
R1800N005		24,00	118
R1800N006		17,40	118
R1800N007		21,20	118
R1800N008		27,20	118
R1800N010		17,40	118
R1810N		19,80	320
R1811N		19,80	317
R1812N		20,30	323
R1814N		36,00	333
R1814N001		33,00	328
R1814N005		52,60	328
R21140		23,70	329
R31140003		34,90	334
R31140004		4,90	334
R32100		32,10	321
R32100003		32,50	321
R32110		28,10	317
R32110001		28,40	317
R37140		41,80	328
R38140018		4,60	334
R38140023		8,90	331
R38140033		8,90	331



Cod.	Stock	€	Pag.
R41140		62,90	329
R43670		30,40	323
R46100		23,30	320
R46100001		20,30	319
R46110		23,90	316
R46110001		20,30	316
R46670		36,50	322
R46670001		29,70	322
R76090		29,10	335
R76100		10,00	320
R76110		10,00	317
R76120		19,50	323
R76120001		30,80	326
R76140		23,20	333
R76140001		22,30	328
R76140002		10,00	332
R8035A		436,00	340
R8035A001		436,00	341
R8035A002		436,00	341
R8035A003		436,00	341
R8035A004		436,00	341
R8035A005		436,00	341
R8035A006		436,00	341
R8035A007		436,00	341
R8035A008		436,00	341
R8035A009		436,00	341
R80750		183,30	341
R80750001		183,30	341
R80750002		183,30	341
R80750003		183,30	341
R80750004		183,30	341
R80750005		183,30	341
R80750006		183,30	341
R80750007		183,30	341
R80750008		183,30	341
R80750009		183,30	341
R8085A		48,90	341
R8085A001		48,90	342
R8085A002		48,90	342
R8085A003		48,90	342
R8085A004		48,90	342
R8085A005		48,90	342
R8085A006		48,90	342
R8085A007		48,90	342
R8085A008		48,90	342
R8085A009		48,90	342
R8085A010		129,70	342
R8085A011		129,70	342
R8085A012		129,70	342
R8085A013		129,70	342
R8085A014		129,70	342
R8085A015		129,70	342
R8085A016		129,70	342
R8085A017		129,70	342
R8085A018		129,70	342
R8085A019		129,70	342
R8085B		129,70	342
R8085B001		129,70	342
R8085B002		129,70	342
R8085B003		129,70	342
R8085B004		129,70	342
R8085B005		129,70	342
R8085B006		129,70	342
R8085B007		129,70	342
R8085B008		129,70	342
R8085B009		129,70	342
R8085B010		164,00	343
R8085C		77,20	343
R8085C001		77,20	343
R8085C002		77,20	343
R8085C003		77,20	343
R8085C004		77,20	343
R8085C005		77,20	343
R8085C006		77,20	343
R8085C007		77,20	343
R8085C008		77,20	343
R8085C009		77,20	343
R8810M		32,20	318
R8810M001		34,30	318
R8810M002		34,30	319
R88120		30,10	324
R88120001		32,20	324
R88120002		48,30	324
R88120003		48,30	325
R88670		11,90	324
RMC016		2,30	338
RMC025		1,60	339
RMC028		2,10	339
RMC029		2,00	339
RMC031		3,10	340
RMC062		6,60	340
RMC116		22,00	339

Cod.	Stock	€	Pag.
RMC128		20,30	338
RM0B7750221		18,60	343
RV0140		11,20	330
RV0140001		8,70	330
RV014A003		37,70	327
RV014A005		5,20	333
RV014A009		15,60	332
RV014A030		37,20	329
RV014B		11,20	330
RV014B001		8,70	331
RV014B003		37,70	327
RV014B004		15,80	333
RV114A002		14,90	331
RV408A		36,60	235/336
RV408A001		66,20	337
RV454A		86,70	338
RV467E		21,50	217
RV8140		36,70	330
VT00301000		64,30	31
VT00302000		64,30	32
VT00303000		80,40	33
VT00304000		59,00	30
VT00305000		59,00	35
VT00306000		59,00	35
VT00307000		75,00	37
VT00308000		53,60	34

Inda si riserva, a proprio insindacabile giudizio, di apportare modifiche anche senza preavviso, allo scopo di migliorare la produzione.

Inda reserves the right to modify the products without advance notice to improve production.

Inda se réserve le droit, à tout moment et à son jugement sans appel, d'apporter des modifications sans préavis, afin d'améliorer la production.

Inda se reserva el derecho de realizar, sin previo aviso, las modificaciones que considere convenientes para mejorar el producto.

INDA France  
142, rue de Rivoli  
75001 PARIS  
commandes.france@inda.net

INDA ESPAÑA s.l.  
Avda. de la Riera, 11  
Nave industrial 4  
08960 Sant Just Desvern (BARCELONA)  
pedidos@inda.net

#### **INDA SpA**

**Registered Office**  
**Operational Headquarters**  
**Via dell'Industria, 41**  
**I-24040 Pagazzano (BG)**

**Bathroom Furniture**  
**Via Postumia Ovest, 72**  
**I-31048 Olmi di San Biagio di Callalta (TV)**

**www.inda.net**  
**info@inda.net**

**Piva: IT03868760962**  
**Registro Imprese di Bergamo: 03868760962**  
**Numero REA: BG – 386581**  
**Capitale Sociale: Euro 4.000.000,00 i.v.**



## ACCESSORIES FINISHES

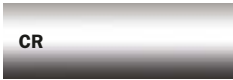

**CR**  
Cromato  
Chrome-plated  
Chromé  
Cromado



**AC**  
Nickel spazzolato  
Brushed nickel  
Nickel brossé  
Níquel cepillado



**CG**  
Cromo nero spazzolato  
Brushed black chrome  
Black chrome brossé  
Cromado negro cepillado



**OR**  
Oro rosato lucido  
Glossy rose-coloured gilded  
Doré rosé brillant  
Cromado rosado brillante



**DR**  
Dorado 24 carati  
Gilded 24 carats  
Doré 24 carats  
Dorado 24 quilates



**BZ**  
Bronzo  
Bronzed  
Bronze  
Bronce



**NE**  
Nero opaco  
Matt black  
Noir mat  
Negro mate



**WM**  
Bianco opaco  
Matt white  
Blanc mat  
Blanco mate



**WZ - WW**  
Bianco lucido  
Glossy white  
Blanc brillant  
Blanco brillante



**NS**  
Acciaio inox spazzolato AISI 304  
Brushed stainless steel AISI 304  
Acier inoxydable brossé AISI 304  
Acero inoxidable cepillado AISI 304



**CU**  
Cromato/nero soft touch  
Chrome-plated/black soft touch  
Chromé/noir soft touch  
Cromado/negro soft touch



**AL**  
Acciaio inox AISI 304  
Stainless steel AISI 304  
Acier inoxydable AISI 304  
Acero inoxidable AISI 304



**AP**  
Alluminio lucido  
Polished aluminium  
Aluminium brillant  
Aluminio brillante



**SL**  
Silver  
Silver  
Silver  
Plata



**SN**  
Silver/nero  
Silver/black  
Silver/noir  
Plata/negro



**NW**  
Nero  
Black  
Noir  
Negro

## GLASS FINISHES



**01**  
Vetro trasparente  
Transparent glass  
Verre transparent  
Vidrio transparente



**02**  
Polimetilmetacrilato  
Polymethyl methacrylate  
Polyméthacrylate de méthyle  
Polimetilmetacrilado



**03**  
Vetro extrachiaro trasparente  
Extra clear transparent glass  
Verre transparent extra clair  
Vidrio extraclaro transparente

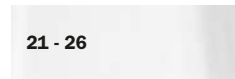

**21 - 26**  
Vetro satinato  
Satined glass  
Verre satiné  
Vidrio satinado

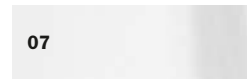

**07**  
Ceramica bianca  
White ceramic  
Céramique blanche  
Ceramica blanca



**04**  
Vetro Fumé  
Fumé glass  
Verre Fumé  
Vidrio Fumé

## MY SECRET FINISHES



**BX** Bianco

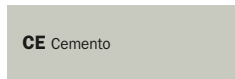

**CE** Cemento

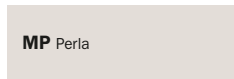

**MP** Perla

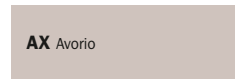

**AX** Avorio

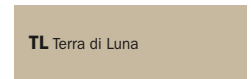

**TL** Terra di Luna

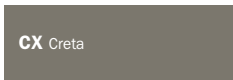

**CX** Creta

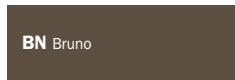

**BN** Bruno

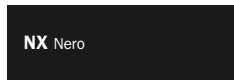

**NX** Nero

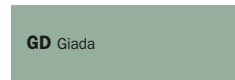

**GD** Giada



**AQ** Acquamarina

## INDISSIMA HPL FINISHES

	Yard	Cemento scuro	Malta	Porfido	Pietra scura	Pietra chiara	Lava	Calacatta	Larice brown	Larice sand	Larice panna	Fiore bianco	Fiore nero	Textil brown	Textil grey	Textil ice
*NS+HPL	HA	HD	HG	HJ	HM	HQ	HT	HW	LA	LD	LG	L J	LM	TB	TF	TJ
*NE+HPL	HB	HE	HH	HK	HN	HR	HU	HX	LB	LE	LH	LK	LN	TC	TG	TK
*WM+HPL	HC	HF	HI	HL	HP	HS	HV	HY	LC	LF	LI	LL	LR	TD	TH	TP



MALTA

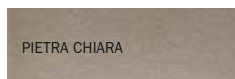

PIETRA CHIARA



PORFIDO

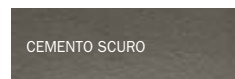

CEMENTO SCURO

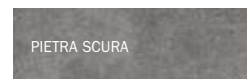

PIETRA SCURA



LAVA

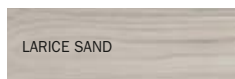

LARICE SAND

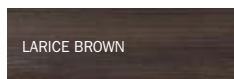

LARICE BROWN

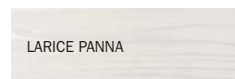

LARICE PANNA



YARD

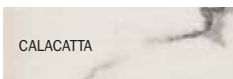

CALACATTA

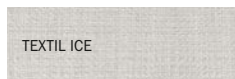

TEXTIL ICE

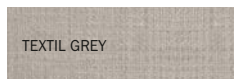

TEXTIL GREY



TEXTIL BROWN

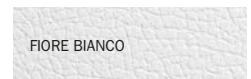

FIORE BIANCO



FIORE NERO

