

# 80

LISTINO PREZZI / PARETI DOCCIA  
PRICE LIST / SHOWER ENCLOSURES





Il nuovo catalogo 80 rappresenta un punto zero nella proposta di Samo.

Ripartiamo dal colore blu, colore che sin dalla fondazione avvenuta nel 1960 rappresenta la nostra azienda: tanti anni di lavoro che testimoniano la nostra competenza ed attaccamento al settore. Abbiamo dedicato tempo ed energie per ripensare completamente quello che da anni rappresenta uno strumento di lavoro di riferimento, utile innanzitutto a voi. Ogni pagina è stata studiata e rivista per essere fruibile da chiunque, perché crediamo che sia importante creare un legame diretto tra la nostra azienda e le persone che scelgono tutti i giorni Samo. Siamo sicuri che apprezzerete tutto il lavoro fatto, pensandolo come il primo passo di un progetto molto più ampio, del quale non vediamo l'ora di parlarvi.

*The new Catalog 80 marks a fresh start for Samo's offerings. We are returning to the color blue, a color that has represented our company since its founding in 1960: many years of work that demonstrate our expertise and commitment to the industry. We have devoted time and energy to completely reimagine what has long been a reference tool, primarily created for you. Every page has been carefully designed and revised to be accessible to everyone, as we believe it is essential to establish a direct connection between our company and the people who choose Samo every day. We are confident that you will appreciate all the work that has gone into this, considering it the first step in a much broader project, which we can't wait to share with you.*

Il Presidente  
The President  
Denis Venturato

**ASSISTENTE DI ZONA / AREA ASSISTANT**

\_\_\_\_\_  
Telefono / Phone number

\_\_\_\_\_  
email

**CAPO AREA / AREA MANAGER**

\_\_\_\_\_  
Telefono / Phone number

\_\_\_\_\_  
email

**AGENZIA DI ZONA / AREA AGENCY**

\_\_\_\_\_  
Telefono / Phone number

\_\_\_\_\_  
email

# INDICE / INDEX

<b>Samo S.p.A</b>	
Siamo Samo / We are Samo	04
Profili / Profiles	06
Vetri / Glass	08
Stampa digitale / Digital Print	12
Piatti doccia / Shower trays	13
Accessori / Accessories	14
Composizione codice / Code Composition	16
Abaco finiture e vetri / Finish and Glass Schedule	18
Scopri la nostra offerta prodotto / Discover our product selection	20
<b>Walk In</b>	
Open 6	60
Open 8	62
Open 8 con mensola parete principale / Open with Shelf main wall	64
Open 8 con mensola parete secondaria / Open with Shelf secondary wall	66
Open 8 screen	68
Open 8 scorrevole	70
Open 8 combinazioni	72
<b>Pareti doccia / Shower walls</b>	
Pyxis	78
Acrux	102
Zenith	122
Polaris	140
Grand Polaris	186
Europa	198
Europa SP	230
Cee Art	248
Cee Art SP	270
America Quattro	286
America Quattro SP	308
America	324
Flex	344
Ciao	356
<b>Pareti Vasca / Bath Screens</b>	
Pareti vasca / Bath Screens	364
<b>Piatti Doccia / Shower Tray</b>	
Piatti doccia / Shower Tray	374
<b>Prodotti Speciali / Special Products</b>	
Prodotti Speciali / Special Products	380
<b>Info e Servizi / Information and Services</b>	
Profili di Compensazione / Compensating and junction profile	386
Attacchi laterali / Side mounts	388
Profili speciali / Special profiles	392
Servizi di pre e post vendita / Pre and Post sales	398
Materiali - Vetro temperato - StarClean / Materials - Tempered glass - StarClean	392
Pulizia prodotti / Product cleaning	402
E-samo Web Services	404
Condizioni generali di trasporto e vendita / General transport and sale terms	406

# SIAMO SAMO / WE ARE SAMO

## SAMO



Da oltre 60 anni, Samo S.p.A. rappresenta l'eccellenza del Made in Italy nel settore delle soluzioni per il bagno, con un forte impegno verso l'innovazione e la ricerca. La nostra missione è offrire esperienze di comfort a 360°, attraverso soluzioni complete che integrano design, tecnologia avanzata e funzionalità. Ogni prodotto è progettato per trasformare lo spazio bagno in un ambiente dove estetica e praticità si fondono armoniosamente, estendendo l'offerta dalle cabine doccia agli accessori e arredi che arricchiscono l'esperienza di benessere quotidiano.

La nostra visione è quella di mantenere la leadership nel mercato globale, continuando a puntare su innovazione e qualità. Con l'introduzione di soluzioni all'avanguardia, come la tecnologia di incollaggio UV per le pareti doccia, Samo si propone di ridefinire continuamente il concetto di lusso e benessere, offrendo ai clienti un'esperienza unica e su misura.

- > 60 anni di storia imprenditoriale
- > 230 dipendenti
- > 50 milioni
- > 55.000 m<sup>2</sup> di stabilimenti produttivi
- > 1.000 pareti doccia prodotti al giorno

*For over 60 years, Samo S.p.A. has represented the excellence of Made in Italy in the bathroom solutions sector, with a strong focus on innovation and research. Our mission is to provide 360-degree comfort experiences through complete solutions that integrate design, advanced technology, and functionality. Each product is designed to transform the bathroom space into an environment where aesthetics and practicality harmoniously blend, extending our range from shower cabins to accessories and furnishings that enhance the daily wellness experience. Our vision is to continue being a global market leader, maintaining our commitment to innovation and quality. By developing cutting-edge solutions, such as UV bonding technology for shower walls, Samo aims to continuously redefine the concepts of luxury and well-being, offering customers a unique and tailored experience.*

- > 60 years of entrepreneurial history
- > 230 employees
- > 50 million
- > 55,000 m<sup>2</sup> of production facilities
- > 1,000 shower walls produced daily

## TECNOLOGIA / TECHNOLOGY



### Incollaggio UV

Soluzione ideale per il fissaggio della componentistica, è la tecnologia d'incollaggio UV, mutuato dalla tecnologia aerea, che ha trovato una grande applicazione nell'industria del vetro in quanto consente di ottenere incollaggi invisibili, ma dotati di un'elevata resistenza meccanica.

Nel corso di questi ultimi anni, il gruppo Samo Industries ha sviluppato questa tecnologia su alcuni dei suoi prodotti. Rispetto all'incollaggio tradizionale, dove l'adesivo viene lasciato asciugare reagendo con l'aria o altre sostanze reagenti, questa tecnologia impiega speciali lampade che emettono raggi UV.

Le colle utilizzate per questa tecnologia polimerizzano una volta esposte ai raggi ultravioletti, garantendo una rapida e sicura giunzione delle parti da unire.

Con questa tecnologia si possono incollare svariate tipologie di materiale, spaziando per diversi settori di utilizzo. Nel nostro caso, questa tecnica è applicata nella giunzione di elementi metallici (cerniere, zanche, maniglie) al vetro.

### UV gluing

*The ideal solution for fixing components is UV gluing technology, borrowed from aeronautic engineering, which has found fantastic applications in the glass industry as it makes it possible to obtain invisible adhesion while guaranteeing a high mechanical resistance.*

*Over the course of 2016, the Samo Industries group developed this technology to be used on some of its products. Compared to traditional gluing, where the adhesive is left to air dry or is set using other reactive substances, this technology uses special lamps that emit UV rays. The glues used for this technology polymerize once they are exposed to ultra-violet rays, guaranteeing a rapid and safe joining of the parts involved. This technology can be used to glue a wide variety of materials, covering various fields of application. In our case, this technique is applied in the joining of metal elements (hinges, fixing elements, handles) to the glass.*

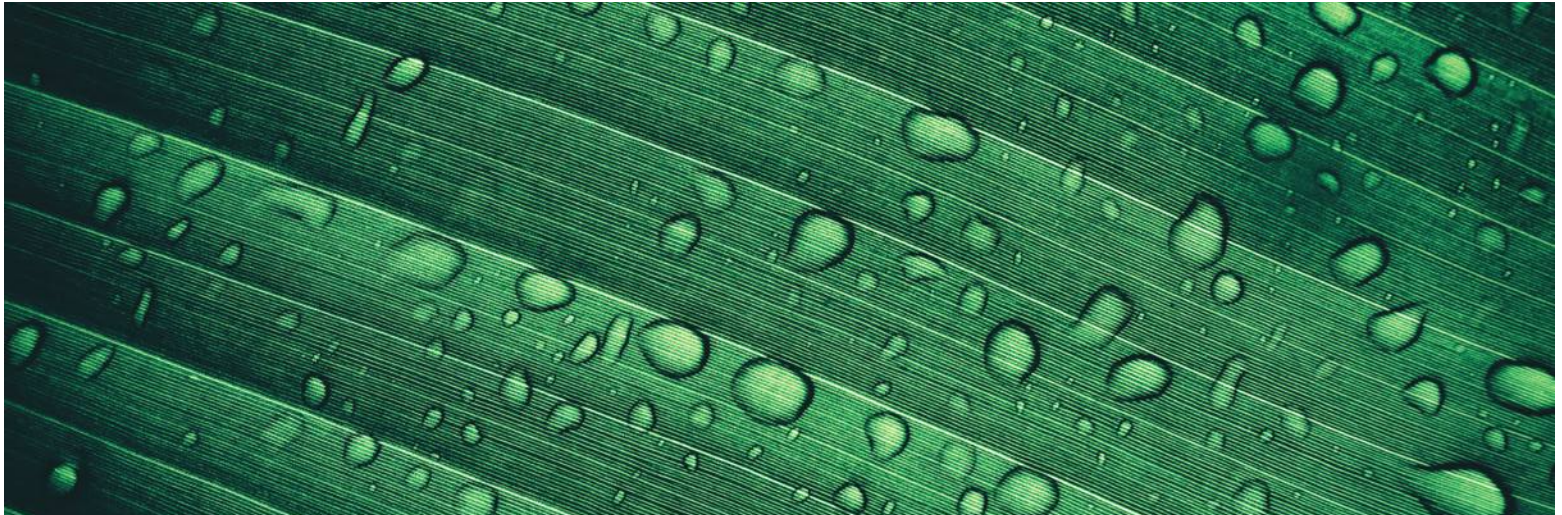

**SAMO utilizza al 100% energia da fonti rinnovabili. Un impegno costante nel tempo.**

Le Garanzie d'Origine GO sono dei certificati internazionali che vengono riconosciuti a quegli impianti di produzione di energia elettrica che rispettano determinate caratteristiche di sostenibilità ambientale. Nati nel 2009, ad oggi sono lo strumento principale per garantire la tracciabilità dell'energia prodotta e sostengono la promozione e lo sviluppo di un mercato su base volontaria dell'energia pulita prodotta da fonti rinnovabili.

L'obiettivo della certificazione GO è quello di garantire al cliente che una quantità di energia pari a quella da lui consumata sia stata prodotta da impianti alimentati da una fonte rinnovabile ben definita in un determinato periodo di tempo. Mediante l'utilizzo di certificati GO, l'acquirente finanzia l'energia pulita testimoniando il proprio impegno a favore dell'ambiente.

Quando l'impegno a favore dell'ambiente e dell'ecosostenibilità delle attività produttive umane facevano i primi vagiti, Samo creò la prima cabina doccia completamente ecologica in collaborazione con Legambiente, realizzata in legno lamellare, alluminio e vetro - materiali riciclabili al 100% - con alcune versioni realizzate con pareti in plastica postconsumo, ovvero in PET riciclato da raccolta differenziata.

Dopo questo primo exploit nel mondo green, l'impegno di Samo si è indirizzato verso il consumo di energia - per la propria attività produttiva - derivata al 100% da fonti rinnovabili.

Come produttori di docce, l'impegno si è poi esteso - attraverso il progetto "Save water" - verso la promozione di un uso consapevole e responsabile dell'acqua, in primo luogo promuovendo quei comportamenti quotidiani che consentano un utilizzo corretto e senza sprechi del bene "acqua", fonte primaria della vita.

A questo impegno fa eco la certificazione CO2 della produzione delle docce, e la compensazione dell'impatto nell'ambiente di diossido di carbonio di tutte le attività di marketing del marchio Samo, attraverso l'acquisto di Carbon Credits.

L'impegno a favore dell'ambiente è un cammino che Samo desidera percorrere da protagonista, con la consapevolezza che non ci si può mai sentire "abbastanza" soddisfatti dei propri passi e dei propri comportamenti, a favore di un'economia realmente sostenibile dal nostro amato pianeta.

**SAMO uses 100% energy from renewable sources**

*The GO - Guarantees of Origin - are recognized international certificates for electricity production factories that respect certain environmental sustainability characteristics. Established in 2009, they are today the main tool ensuring the traceability of the energy produced and supporting the promotion and development of the market for clean energy produced from renewable resources.*

*The aim of GO certification is to ensure the customer that an amount of energy equal to that which they have consumed has been produced by factories powered by a well-defined renewable source over a given period of time. Through the use of GO certificates, the buyer finances clean energy by demonstrating its commitment to the environment.*

*When the commitment to the environment and the eco-sustainability of production activities were making their first stirrings, Samo created the first completely ecological shower enclosure in collaboration with Legambiente, made of laminated wood, aluminum and glass 100% recyclable materials - with some versions made with panels in recycled plastic or recycled PET from selective sorting.*

*After this first success in the green world, Samo's commitment has been directed towards the consumption of energy - for its production activity - made from 100% renewable sources. As manufacturer of showers, the commitment then extended - through the "Save water" project - towards the promotion of a conscious and responsible use of water, first of all by promoting daily behaviors that allow a correct use and without waste of water, primary source of life.*

*This commitment is characterized by the CO2 certification of the production of showers, and the compensation of the carbon dioxide impact on the environment of all the marketing activities of the Samo brand, through the purchase of Carbon Credits.*

*The commitment to the environment is a path that Samo wishes to take as a protagonist, while being aware that one is never completely satisfied with his own approaches and behavior, in favor of a truly sustainable economy for our beloved planet.*

# PROFILI / PROFILES

## STANDARD

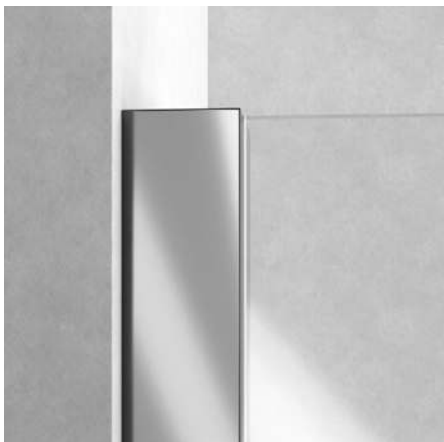

### ULU

**Brillantato Lucido**  
Ossidazione anodica  
**Brilliant Polished**  
Anodic oxidation

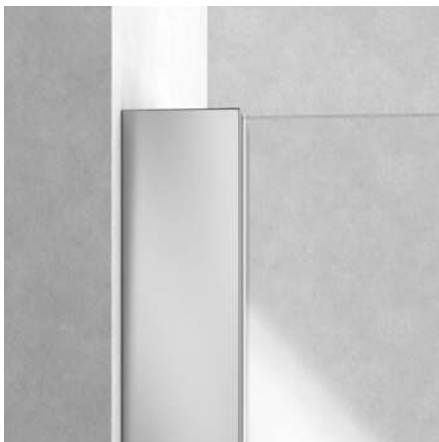

### SAR

**Satinato Argentato**  
Ossidazione anodica  
**Silver Glazed Satin**  
Anodic oxidation

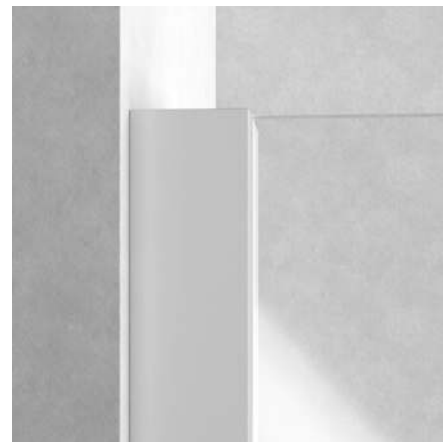

### L91

**Bianco Opaco**  
Verniciatura a polvere effetto opaco  
**Matte White**  
Matte finish powder coating

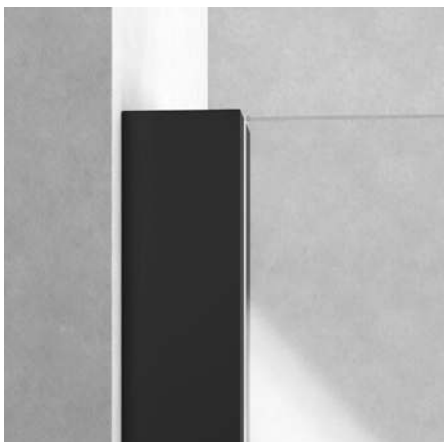

### L96

**Nero Opaco**  
Verniciatura a polvere effetto opaco  
**Matte Black**  
Matte finish powder coating

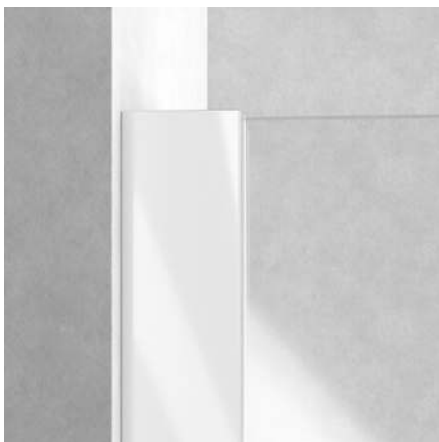

### L01

**Bianco Lucido**  
Verniciatura a polvere effetto lucido  
**Brilliant Polished**  
Glossy finish powder coating

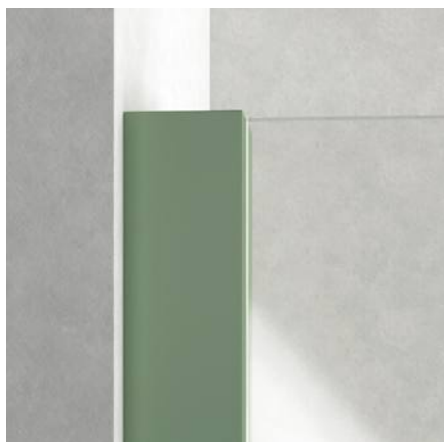

**L73**  
**Sage Opaco**  
Verniciatura a polvere effetto opaco  
**Matte Sage**  
Matte finish powder coating

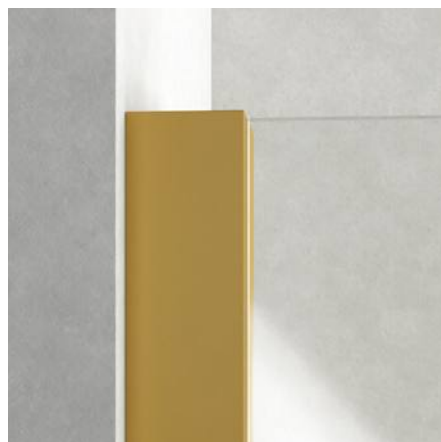

**L86**  
**Ambra Opaco**  
Verniciatura a polvere effetto opaco  
**Matte Ambra**  
Matte finish powder coating

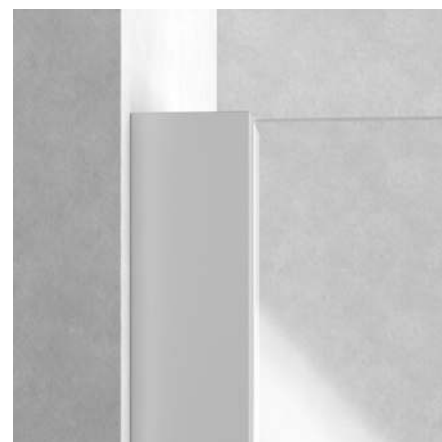

**L90**  
**Artic Opaco**  
Verniciatura a polvere effetto opaco  
**Matte Artic**  
Matte finish powder coating

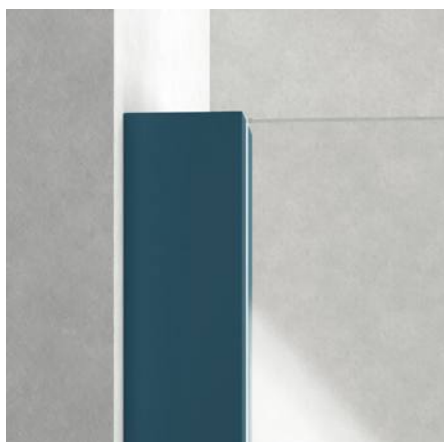

**L92**  
**Sailor Blue Opaco**  
Verniciatura a polvere effetto opaco  
**Matte Sailor Blue**  
Matte finish powder coating

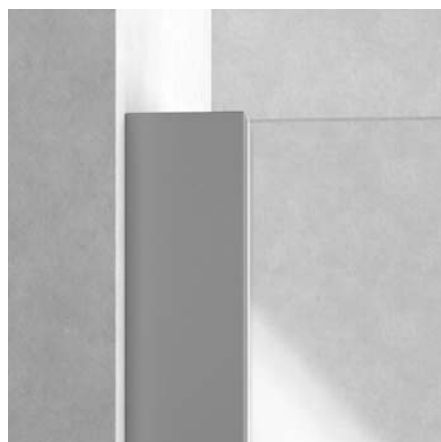

**L95**  
**Grigio Opaco**  
Verniciatura a polvere effetto opaco  
**Matte Grey**  
Matte finish powder coating

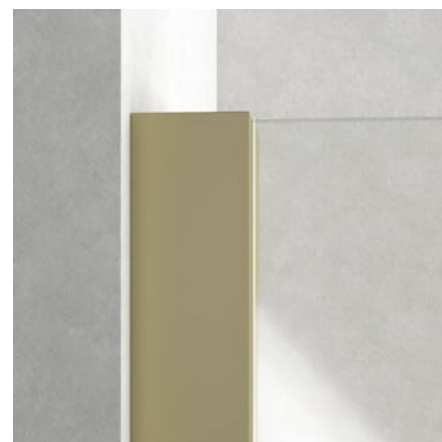

**L98**  
**Sabbia Opaco**  
Verniciatura a polvere effetto opaco  
**Matte Sand**  
Matte finish powder coating

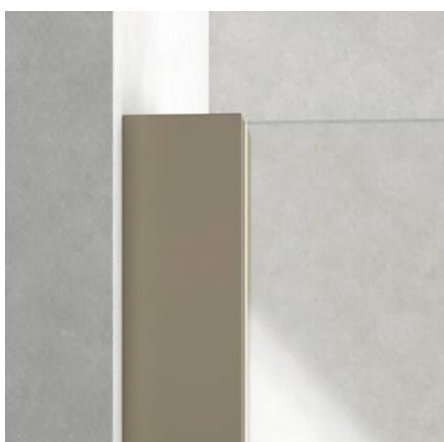

**L99**  
**Tortora Opaco**  
Verniciatura a polvere effetto opaco  
**Matte Dove**  
Matte finish powder coating

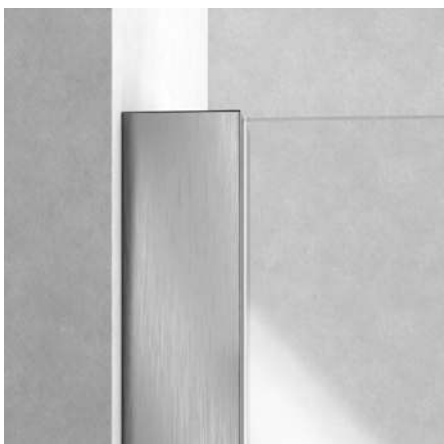

**SNK**

**Nickel Spazzolato**  
Ossidazione anodica  
*Brushed Nickel*  
Anodic oxidation

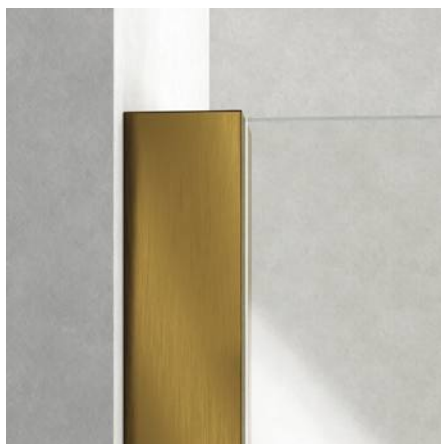

**AL4**

**Bronzo Spazzolato**  
Verniciatura a liquido multistrato  
*Brushed Bronze*  
Multi-layer liquid coating

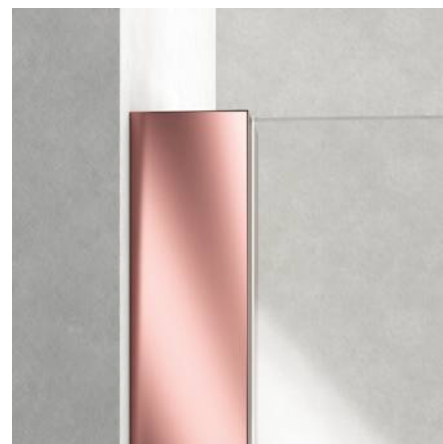

**AL5**

**Oro Rosa Lucido**  
Ossidazione anodica  
*Polished Rose Gold*  
Anodic oxidation

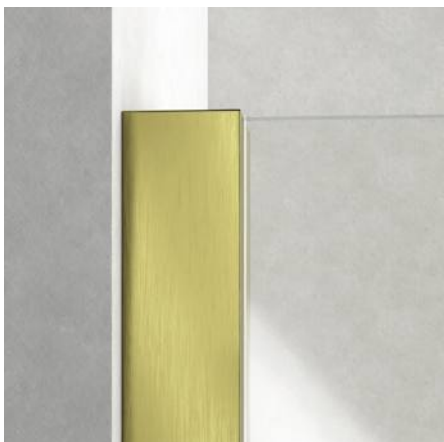

**GLB**

**Oro Spazzolato**  
Ossidazione anodica  
*Brushed Gold*  
Anodic oxidation

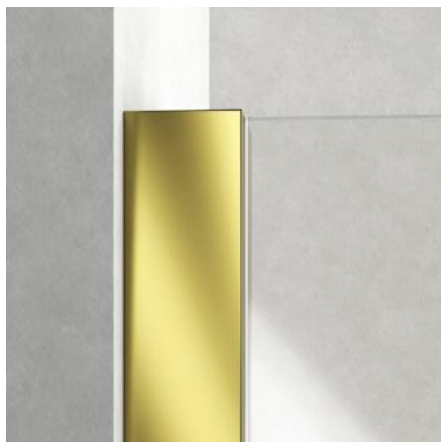

**GLP**

**Oro Lucido**  
Ossidazione anodica  
*Polished Gold*  
Anodic oxidation

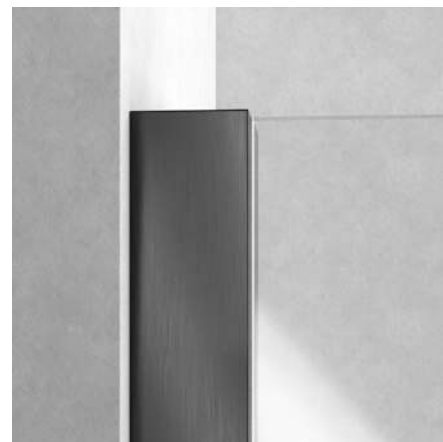

**GMB**

**Gun Metal Spazzolato**  
Ossidazione anodica  
*Brushed Gun Metal*  
Anodic oxidation

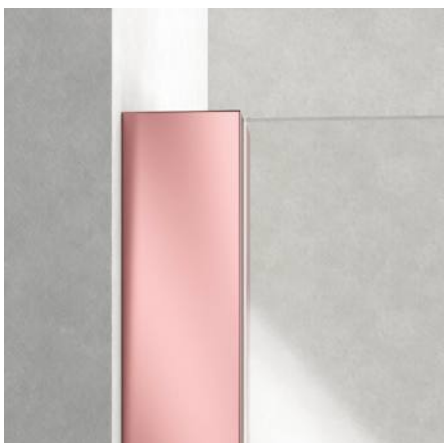

**L55**

**Rosa Metallizzato**  
Verniciatura a liquido effetto metallizzato  
*Metallic Pink*  
Metallic finish liquid coating

# VETRI / GLASS



**TR**  
Trasparente  
*Transparent*



**TE**  
Extrachiaro  
*Extra Clear*



**TG**  
Trasparente Grigio  
*Transparent Grey*



**AS / RS**  
Satinato  
*Satin*



**GS**  
Satinato Grigio  
*Satin Grey*



**RF**  
Fascia Satinata H.100cm  
*Satin Band H.100cm*



**ST**  
Stampato  
*Printed*



**SY**  
Specchio  
*Mirror*

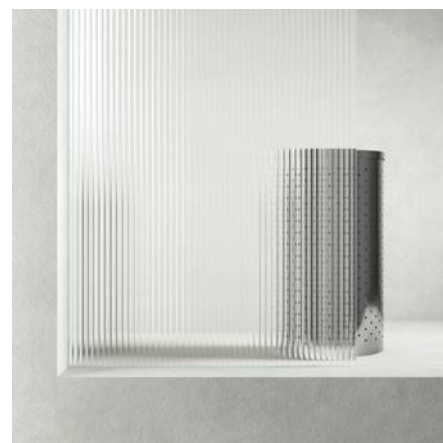

**TC**  
Trasparente Cannettato  
*Transparent Flutes*  
Disponibile solo per Open 6  
*Available only for Open 6*



**TN**

**Sfumato Nuvola**  
*Cloud gradient finish*

Disponibile solo per Open 8  
*Available only for Open 8*

**POLISTIRENE / POLYSTIRENE**



**SE**

**Setola**  
*Setola*



**JU**

**Juta**  
*Juta*

# STAMPA DIGITALE / DIGITAL PRINT

La tecnologia di stampa digitale su vetro è una tecnica avanzata che permette di stampare, su lastre in vetro temperato, immagini e fotografie, disegni e scritte ricevute tramite un supporto digitale. Si tratta di una stampa ad alta definizione e in quadricromia: il getto d'inchiostro ceramico a 4 colori in un'unica applicazione garantisce un'ottima risoluzione dell'immagine sulla superficie del vetro e la massima durata nel tempo, ricreando infinite sfumature. In particolare la stampa digitale consiste nell'utilizzo di speciali vernici ceramiche che, vetrificando durante il processo di tempra, garantiscono inalterata nel tempo la qualità dell'immagine impressa sul vetro.

Il processo di serigrafia è stato fino ad ora il solo modo di decorare vetri con vernici colorate.

La serigrafia necessita dell'utilizzo di specifici telai serigrafici per applicare la vernice e riprodurre l'immagine ed è possibile applicare un solo colore alla volta senza poter donare all'immagine sfumature o gradazioni cromatiche.

Con la stampa digitale le immagini, le fotografie e i disegni sono elaborati da un software dedicato della stampante che riproduce fedelmente il soggetto utilizzando contemporaneamente i 4 colori in un unico passaggio di stampa garantendo, quindi, un'altissima qualità di definizione, colori con sfumature e giochi di trasparenza.

Stampe il cui aspetto, intensità e colore, non si sbiadiranno con il tempo per il contatto con l'acqua o l'uso quotidiano della parete doccia.

L'immagine da stampare dovrà essere in alta risoluzione (risoluzione di almeno 300 DPI, dimensioni minime 21x30cm) in formato digitale (.jpg, .tif) o in formato vettoriale (.ai, .pdf, .eps)

**La stampa digitale è realizzabile solamente su vetro trasparente (TR) ed è possibile la stampa anche di immagini personalizzate.**

Attenzione: la percezione visiva di un'immagine può cambiare a seconda del supporto sulla quale viene realizzata: la stessa immagine ha una resa cromatica diversa a seconda che venga stampata su carta, vetro, o a video.

*Digital printing technology on glass is an advanced technique that allows the printing of images, photographs, designs, and text onto tempered glass sheets using a digital medium. This high-definition, four-color (CMYK) printing process uses ceramic ink jets in a single application, ensuring excellent image resolution on the glass surface and long-lasting durability, reproducing endless shades. Specifically, digital printing uses special ceramic paints that, when vitrified during the tempering process, maintain the quality of the image on the glass over time.*

*Previously, the silkscreen process was the only method to decorate glass with colored paints. Silkscreen printing requires specific frames to apply the paint and reproduce the image, but it can only apply one color at a time, without the ability to create gradients or color shading.*

*With digital printing, images, photographs, and designs are processed by the printer's dedicated software, which accurately reproduces the subject using all four colors in a single printing pass. This results in exceptionally high-definition images, with colors, shading, and transparency effects. The prints will not fade over time, even with exposure to water or daily use, such as on a shower wall.*

*The image to be printed must be in high resolution (at least 300 DPI, minimum dimensions of 21x30cm) in a digital format (.jpg, .tif, .eps, .raw) or vector format (.ai).*

**Digital printing is only possible on transparent glass (TR), and custom images can also be printed.**

Note: Visual perception of an image may vary depending on the material it is printed on. The same image will have different color renditions when printed on paper, glass, or displayed on a screen.

Vetro di base Base Glass	TR	TR	TR
Finitura Profili Profile Finish	Tutte le finiture All finishes	Tutte le finiture (eccetto bianco L91-L01) All finishes (except white L91-L01)	Bianco (L91-L01)
Stampa digitale Digital Print	DD-DM-DH-DI-DK-DN Custom	DG	DG
Colore stampa Print Color	Bianco White	Nero Black	Bianco White
<b>L</b> <b>[cm]</b>			
<101cm	<b>300,00</b>	<b>300,00</b>	<b>300,00</b>
101.1÷151cm	<b>600,00</b>	<b>600,00</b>	<b>600,00</b>
>151.1cm	<b>900,00</b>	<b>900,00</b>	<b>900,00</b>

 Sulla stampa DG "Griglia" è possibile richiedere la stampa di colore nero anche in abbinamento a profili di colore bianco e la stampa bianca su tutte le altre finiture di profilo. L'indicazione va comunicata in fase d'ordine.  
*On the DG "Griglia" print, it is possible to request black print color, even when paired with white profiles, and white print on all other profile finishes. This specification should be communicated at the time of order.*



**DD**  
Brezza

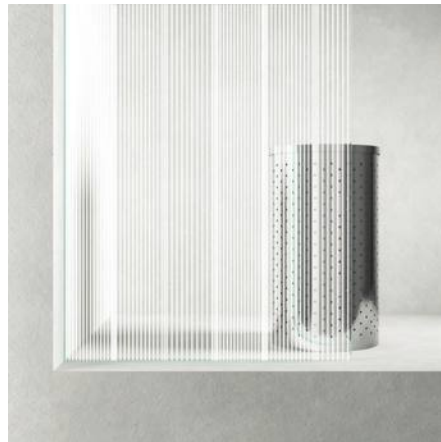

**DM**  
Wave



**DH**  
Cubix



**DI**  
Fronda



**DK**  
Exagon



**DN**  
Rombi



**N6**  
Nouveau



**DL**  
Frame



**DG**  
Griglia

# PIATTI DOCCIA / SHOWER TRAYS

## STONEFIT

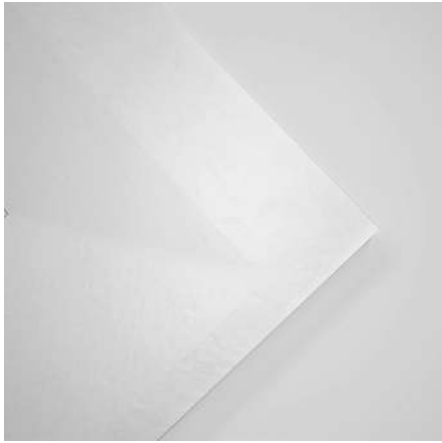

**R01**

**Bianco**

Abbinabile a finitura L91

**White**

Compatible with L91 finish

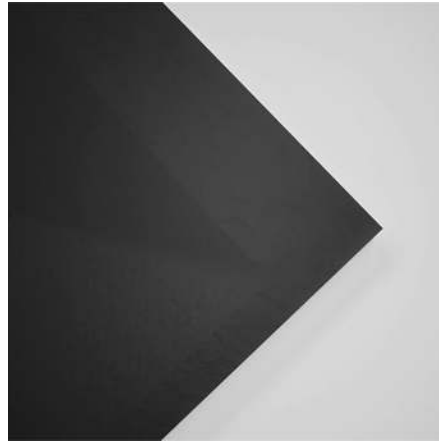

**R06**

**Nero**

Abbinabile a finitura L96

**Black**

Compatible with L96 finish



**R08**

**Sabbia**

Abbinabile a finitura L98

**Sand**

Compatible with L98 finish



**R10**

**Artic**

Abbinabile a finitura L90

**Artic**

Compatible with L90 finish



**R17**

**Grigio**

Abbinabile a finitura L95

**Grey**

Compatible with L95 finish



**R19**

**Tortora**

Abbinabile a finitura L99

**Dove**

Compatible with L99 finish

## STONE



**R01**

**Bianco**

**White**



**R06**

**Nero**

**Black**



**R17**

**Grigio**

**Grey**

# ACCESSORI / ACCESSORIES

## ALLUMINIO / ALUMINIUM



**.09**  
Bianco Goffrato  
*Embossed White*



**.18**  
Nero Goffrato  
*Embossed Black*



**.29**  
Brillantato Lucido  
*Polished Brilliant*



**.73**  
Sage Opaco  
*Matte Sage*



**.86**  
Ambra Opaco  
*Matte Ambra*

## METACRILATO / METACRYLATE



**.80**  
Bianco  
*White*



# COMPOSIZIONE CODICE / CODE COMPOSITION

L [cm]	COD.	A [cm]	B [cm]	C [cm]	[dm3]	[kg]	[Pcs]	V	ULU	L96	L91	ATELIER	DOLCEVITA
137-139	B1744	53	67	68	260	51	2	TR					
								TG					



**B 1744 ULU TR /DX**

Identifica la particolarità del prodotto  
(Non è sempre necessaria)

**DX = versione destra o lato destro**

Identify the product specificity  
(Not always necessary)

**DX = right hand side version or right side**

Finitura pannelli

**TR = vetro trasparente**

Panels finish

**TR = transparent glass**

Finitura profili

**ULU = Brillantato lucido**

Profiles finish

**ULU = Brilliant polished**

Serie, modello e misura del prodotto

**B1744 = Pyxis, porta battente pivot su fisso in linea, 137-139 cm.**

Series, model and size of the product

**B1744 = Pyxis, Pivot hinge door on fixed inline panel, 137-139 cm.**

Tipologia di prodotto

**B = pareti doccia**

Type of product

**B = shower enclosure**

# COMPOSIZIONE CODICE SPECIALE / SPECIAL CODE COMPOSITION

L [cm]	COD.	A [cm]	B [cm]	C [cm]	[dm3]	[kg]	[n°]	V	ULU	L96	L91	DOLCEVITA
117-121	B3984	43,5	69,1	68	138	42	1	TR				
								AS-RF				



Per la creazione del codice del prodotto speciale bisogna aggiungere la lettera S tra la lettera B (Tipologia di prodotto) e il numero di Serie del modello-misura  
 To create the special product code, add the letter "S" between the letter "B" and the "serial number" of the requested article









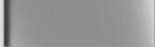
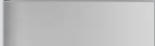
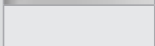
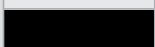
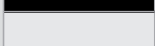

Per la creazione del codice del prodotto speciale con StarClean optional bisogna aggiungere la lettera R tra la lettera B (Tipologia di prodotto) e il numero di Serie del modello-misura  
 To create the special product code with optional StarClean, you must add the letter R between the letter B (Product Type) and the serial number of the model-size

Standard	Maggiorazione Surcharge	Forme Speciali / Special Shapes			
	<b>+20%</b>	 ALTEZZA inferiore <sup>1</sup> Lower HEIGHT <sup>1</sup>	 ALTEZZA superiore <sup>1</sup> Greater HEIGHT <sup>1</sup>	 LARGHEZZA inferiore <sup>2</sup> Lower WIDTH <sup>2</sup>	 LARGHEZZA superiore <sup>2</sup> Greater WIDTH <sup>2</sup>
	<b>+20%</b>	 ALTEZZA inferiore LARGHEZZA inferiore <sup>2</sup> Lower HEIGHT / Lower WIDTH <sup>2</sup>	 ALTEZZA superiore LARGHEZZA inferiore <sup>2</sup> Greater HEIGHT / Lower WIDTH <sup>2</sup>	 ALTEZZA inferiore LARGHEZZA superiore <sup>2</sup> Lower HEIGHT / Greater WIDTH <sup>2</sup>	 ALTEZZA superiore LARGHEZZA superiore <sup>2</sup> Greater HEIGHT / Greater WIDTH <sup>2</sup>
	<b>+30%</b>	 VETRO ritagliato <sup>2</sup> GLASS Beveled <sup>2</sup>	 VETRO sopra muretto <sup>2</sup> GLASS over a low wall <sup>2</sup>	 VETRO sagomato <sup>2</sup> GLASS round <sup>2</sup>	 LARGHEZZA ante personalizzata <sup>2</sup> WIDTH customized doors <sup>2</sup>
	<b>T.B.D</b>	Tipologie di prodotti speciali non contemplate nella tabella qui sopra. Si prega di contattare l'ufficio clienti per avere maggiori informazioni per fattibilità, quantità minime e prezzo dedicato. Types of special products not included in the table above. Please contact customer service for more information on feasibility, minimum quantities, and dedicated pricing.			

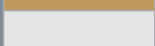
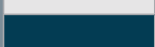





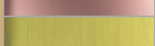
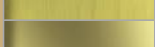
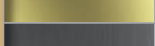
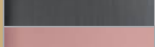



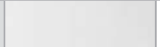

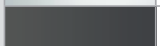
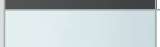
<sup>1</sup> Altezza custom: Sommare maggiorazione al prezzo della misura di riferimento / Custom height: Add a surcharge to the price of the reference size

<sup>2</sup> Larghezza o Altezza+Larghezza: Sommare maggiorazione al prezzo della misura superiore / Custom width or height+width: Add a surcharge to the price of the next larger size

# FINITURE / FINISHES

				OPEN	PYXIS	ACRUX	ZENITH	POLARIS	ALTER	GRAND POLARIS	EUROPA	EUROPA SP	CEE ART	CEE ART SP	AMERICA QUATTRO	AMERICA QUATTRO SP	AMERICA	FLEX	CIAO	PARETI VASCA BATHUB WALLS	
STANDARD		<b>ULU</b>	Brillantato Lucido <i>Brilliant Polished</i>	•	•	•	•	•	•	•	•	•	•	•	•	•				•	
		<b>SAR</b>	Argento Opaco <i>Silver Glazed Satin</i>			•					•	•									
		<b>L91</b>	Bianco Opaco <i>Matte White</i>	•	•	•		•	•	•			•	•	•	•					
		<b>L96</b>	Nero Opaco <i>Matte Black</i>	•	•	•		•	•	•			•	•	•	•					
		<b>L01</b>	Bianco Lucido <i>Glossy White</i>								•	•	•				•	•	•	•	
ATELIER		<b>L73</b>	Sage Opaco <i>Matte Sage</i>	•																	
		<b>L86</b>	Ambra Opaco <i>Matte Ambra</i>	•																	
		<b>L90</b>	Artic Opaco <i>Matte Artic</i>			•															
		<b>L92</b>	Sailor Blue Opaco <i>Matte Sailor Blue</i>			•															
		<b>L95</b>	Grigio Opaco <i>Matte Grey</i>			•							•	•							
		<b>L98</b>	Sabbia Opaco <i>Matte Sand</i>			•															
		<b>L99</b>	Tortora Opaco <i>Matte Dove</i>			•															
DOLCEVITA		<b>SNK</b>	Nickel Spazzolato <i>Brushed Nickel</i>	•	•	•		•													
		<b>AL4</b>	Bronzo Spazzolato <i>Brushed Bronze</i>	•	•	•		•													
		<b>AL5</b>	Oro Rosa Lucido <i>Polished Rose Gold</i>	•	•	•		•													
		<b>GLB</b>	Oro Spazzolato <i>Brushed Gold</i>	•	•	•		•													
		<b>GLP</b>	Oro Lucido <i>Polished Gold</i>	•	•	•		•													
		<b>GMB</b>	Gun Metal Spazzolato <i>Brushed Gun Metal</i>	•	•	•		•													
		<b>L55</b>	Rosa Metallizzato <i>Metallic Pink</i>		•																

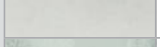
# VETRI / GLASSES

			OPEN	PYXIS	ACRUX	ZENITH	POLARIS	ALTER	GRAND POLARIS	EUROPA	EUROPA SP	CEE ART	CEE ART SP	AMERICA QUATTRO	AMERICA QUATTRO SP	AMERICA	FLEX	CIAO	PARETI VASCA BATHUB WALLS
VETRO / GLASS		<b>TR</b> Trasparente Transparent	•	•	•	•	•	•	•	•	•	•	•	•	•	•	•	•	•
		<b>TE</b> Extrachiaro Extra Clear	•	•	•	•	•	•	•	•	•	•	•						
		<b>TG</b> Trasparente Grigio Transparent Grey	•	•	•	•	•	•	•	•	•	•	•						
		<b>AS</b> Satinato Satin	•		•		•	•	•	•	•	•	•	•					
		<b>RS</b> Satinato Satin																	•
		<b>GS</b> Satinato Grigio Satin Grey	•		•		•	•	•	•	•	•	•	•					
		<b>RF</b> Fascia Satinata H.100cm Satin Band H.100cm	•	•	•	•	•	•	•	•	•	•	•	•		•			
		<b>ST</b> Stampato Printed	•		•		•	•	•	•	•	•	•	•	•		•		•
		<b>SY</b> Specchio Mirror	•		•		•	•	•	•	•	•	•	•					
		<b>TC</b> Trasparente Cannettato Transparent Flutes	•																
		<b>TN</b> Sfumato Nuvola Cloud gradient finish	•																
		<b>SE</b> Setola Setola																•	•
	<b>JU</b> Juta Juta															•		•	

- Vetro proposto di serie nell'offerta prodotto  
Glass offered as standard in the product range
- Vetro proposto su richiesta come prodotto speciale  
Glass offered on request as a special product

## **SCOPRI LA NOSTRA OFFERTA PRODOTTI DISCOVER OUR PRODUCT SELECTION**

Abbiamo riorganizzato la nostra offerta prodotti, rendendo la navigazione del catalogo 80 più fluida e strutturata.

Troverai una prima sezione interamente dedicata al nostro mondo Walk-In declinata attraverso le numerose varianti della nostra serie Open.

A seguire troverai tutte le nostre Pareti Doccia, a partire dall'ultima arrivata Pyxis, simbolo di ricerca tecnica, attenzione al design e cura del dettaglio, fino ad arrivare ai nostri prodotti storici che hanno reso Samo un marchio di riferimento nello spazio bagno.

Per chiudere l'esplorazione dei nostri prodotti, abbiamo riservato una sezione alle Pareti Vasca ed una ai nostri Piatti Doccia, per chiunque voglia creare un bagno completamente coordinato a livello cromatico.

*We have reorganized our product offerings, making the navigation of the catalog 80 more fluid and structured. You will find a first section entirely dedicated to our Walk-In world, featuring the numerous variants of our Open series. Following that, you will discover all our Shower Enclosures, starting with the latest addition, Pyxis, which symbolizes technical research, attention to design, and meticulous detail, all the way to our historic products that have made Samo a benchmark brand in the bathroom space. To conclude the exploration of our products, we have reserved a section for Bathtub Walls and another for our Shower Trays, for anyone looking to create a fully coordinated bathroom in terms of color.*

**WALK-IN**

**CONFIGURAZIONE  
CONFIGURATION**

OPEN 6

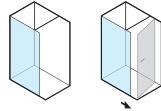

OPEN 8

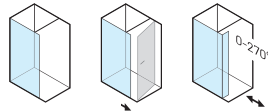

OPEN 8 MENSOLA

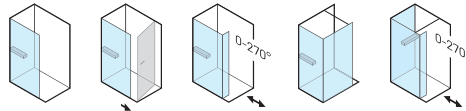

OPEN 8 SCREEN

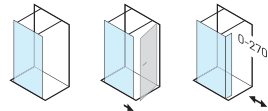

OPEN 8 SCORREVOLE

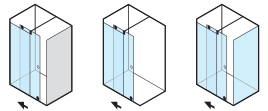

**PARETI DOCCIA**  
**SHOWER ENCLOSURES**

 CONFIGURAZIONE IN NICCHIA  
NICHE CONFIGURATION

 CONFIGURAZIONE IN ANGOLO  
CORNER CONFIGURATION

PYXIS		
ACRUX		
ZENITH		
POLARIS / ALTER		
GRAND POLARIS		
EUROPA		
EUROPA SP		
CEE ART		
CEE ART SP		

CONFIGURAZIONE A TRE LATI  
THREE-SIDED CONFIGURATION

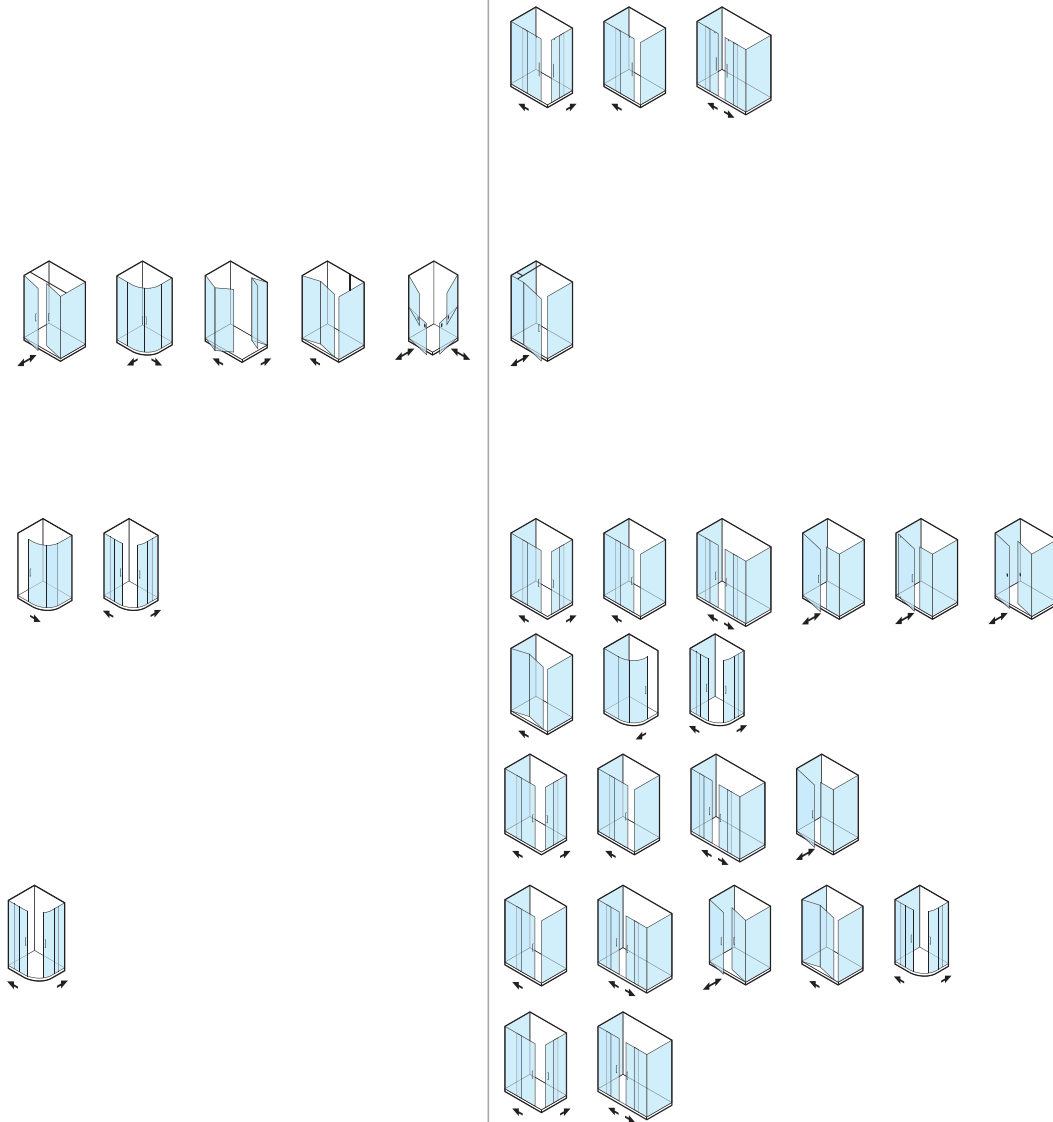

**PARETI DOCCIA**  
**SHOWER ENCLOSURES**

 CONFIGURAZIONE IN NICCHIA  
NICHE CONFIGURATION

 CONFIGURAZIONE IN ANGOLO  
CORNER CONFIGURATION

AMERICA QUATTRO

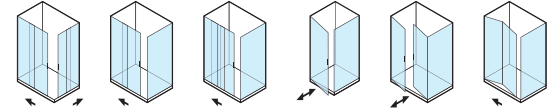
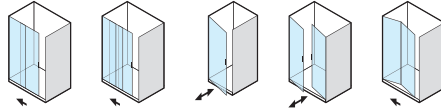

AMERICA QUATTRO SP

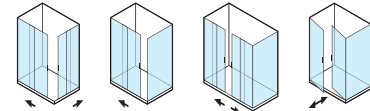
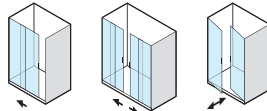

AMERICA

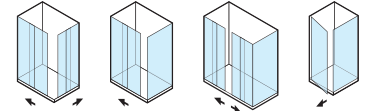
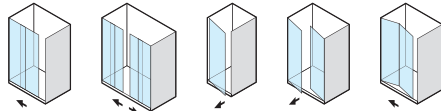

FLEX

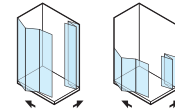
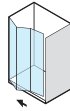

CIAO

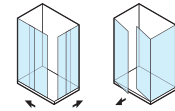
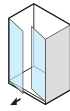

**PARETI VASCA**  
**BATHUB WALLS**

CONFIGURAZIONE  
CONFIGURATION

6mm

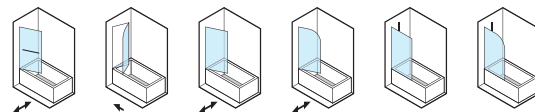

3mm

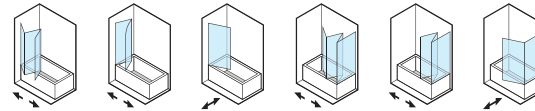

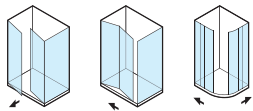
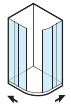

■ CONFIGURAZIONE A TRE LATI  
□ THREE-SIDED CONFIGURATION

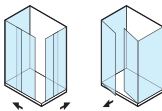
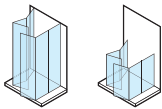
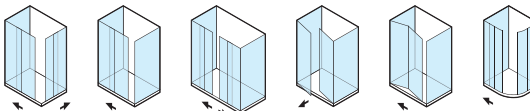
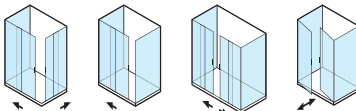
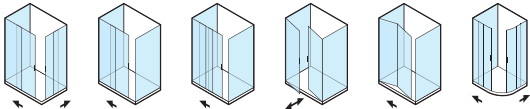

## WALK-IN

La serie Open caratterizza la sezione dedicata ai prodotti Walk-In di Samo.

Abbiamo introdotto le nostre esclusive finiture DolceVita anche su Open 6 per poter creare raffinati giochi cromatici in abbinata con il nuovo vetro cannettato.

Open 6 inoltre, grazie ad un importante restyling, acquisisce la possibilità di abbinarci la porta di chiusura, per chiunque abbia la necessità di avere maggiore intimità nel proprio spazio doccia.

Tutta la gamma Open ha subito un piccolo re-naming per creare maggiore chiarezza e family feeling, per evitare confusione e disorientamento.

*The Open series characterizes the section dedicated to Samo's Walk-In products.*

*We have introduced our exclusive DolceVita finishes to Open 6 as well, enabling refined color combinations alongside the new fluted glass.*

*Additionally, thanks to a major restyling, Open 6 now offers the option of a closing door for those who prefer added privacy in their shower space.*

*The entire Open range has undergone a slight renaming to enhance clarity and family cohesiveness, avoiding confusion and disorientation.*

**WALK-IN**

**CONFIGURAZIONE  
CONFIGURATION**

OPEN 6

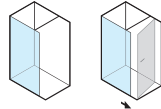

OPEN 8

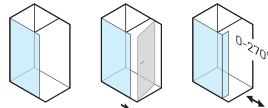

OPEN 8 MENSOLA

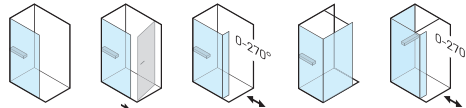

OPEN 8 SCREEN

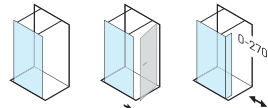

OPEN 8 SCORREVOLE

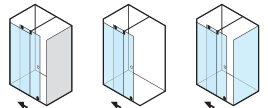









#### **KIT SOSTEGNO STANDARD**

Open 8 Scorrevole nella sua dotazione standard prevede un kit di sostegno ruotabile fino a 50° per lasciare la possibilità di installare il supporto sia sulla parete opposta rispetto all'ingresso della doccia, sia sulla parete laterale, in base a gusti estetici o all'eventuale necessità di evitare ostacoli come finestre o altri elementi.

#### **STANDARD SUPPORT KIT**

*The Open 8 Sliding model in its standard configuration includes a support kit that rotates up to 50°, allowing the support to be installed either on the wall opposite the shower entrance or on the side wall. This flexibility accommodates aesthetic preferences or practical needs to avoid obstacles such as windows or other elements.*





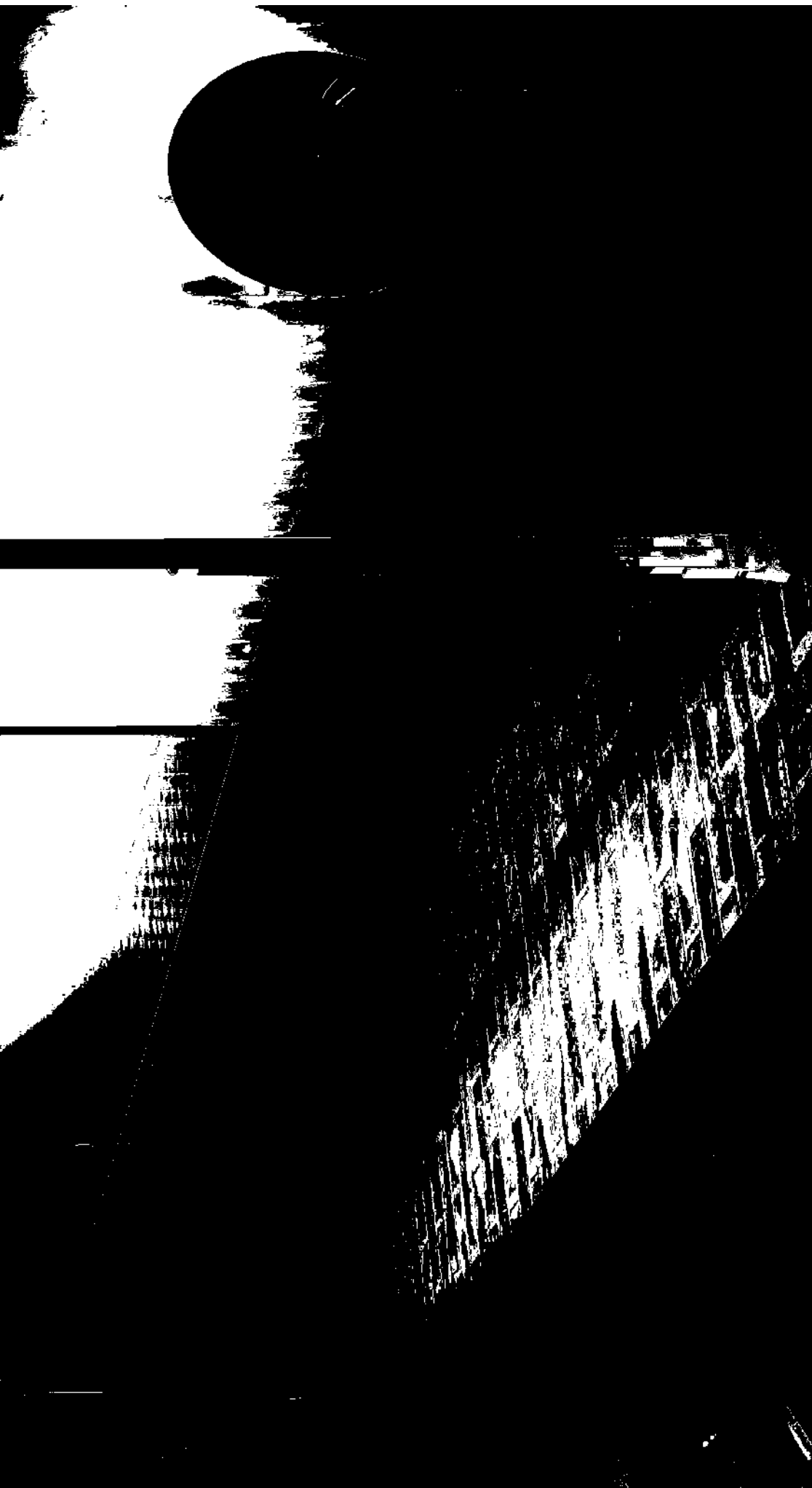

#### **KT4650 / KIT SOSTEGNO IN LINEA**

Abbiamo previsto la possibilità di ordinare un kit di sostegno alternativo per il proprio Open 8 Scorrevole. Il kit KT4650 soddisferà tutti coloro che sono alla ricerca di un sostegno assolutamente lineare e minimale o che possono trovare difficoltà ad utilizzare il kit standard, a causa di ostacoli od impedimenti nella proprio zona bagno.

#### **KT4650 / INLINE SUPPORT KIT**

*We offer the option to order an alternative support kit for the Open 8 Sliding model. The KT4650 kit is perfect for those seeking a completely linear and minimalist support or for anyone who may find it challenging to use the standard kit due to obstacles or constraints in their bathroom space.*

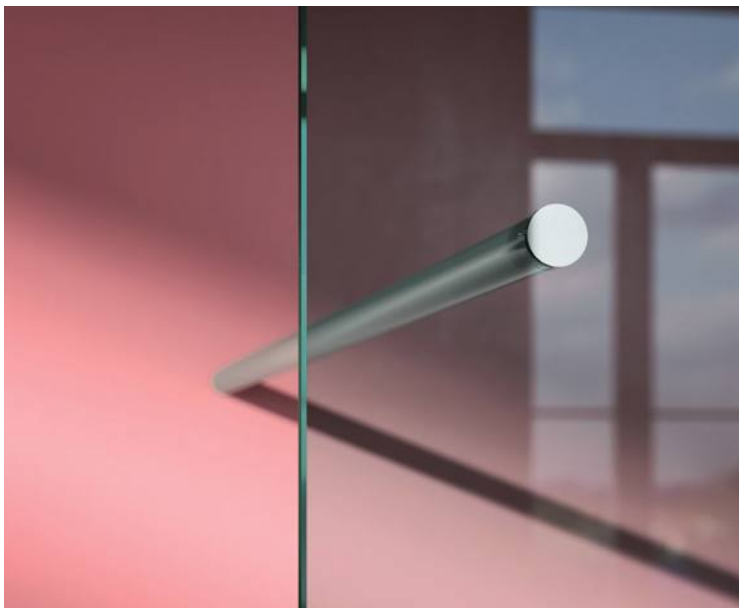

#### **KTO / KIT SOSTEGNO PALO**

Per chiunque desideri un kit di sostegno minimale e che non interrompa il correre del filo della lastra di vetro, è possibile richiedere al momento dell'ordine il Kit Sostegno Palo con codice KTO.

Attenzione a valutare al meglio gli ingombri e gli ostacoli sulla parete opposta alla lastra di vetro per evitare problemi durante l'installazione del prodotto.

#### **KTO / POLE SUPPORT KIT**

*For those seeking a minimalist support kit that maintains the uninterrupted line of the glass panel, the KTO Pole Support Kit can be requested when ordering. Be sure to carefully consider any obstructions or obstacles on the wall opposite the glass panel to avoid issues during product installation.*



#### **KT1400 / ZANCA SNODATA**

La serie Open (no Open 8 Scorrevole) prevede anche una zanca snodata, disponibile come optional, che permette di sostenere la doccia dalla parete laterale e non dalla parete opposta.

Questa zanca si rende necessaria quando sono presenti limiti od ostacoli sulla parete opposta alla lastra di vetro.

#### **KT1400 / ARTICULATED BRACKET**

*The Open series (excluding Open 8 Sliding) also offers an optional articulated bracket that supports the shower from the side wall rather than the opposite wall. This bracket is essential when there are limitations or obstacles on the wall opposite the glass panel.*

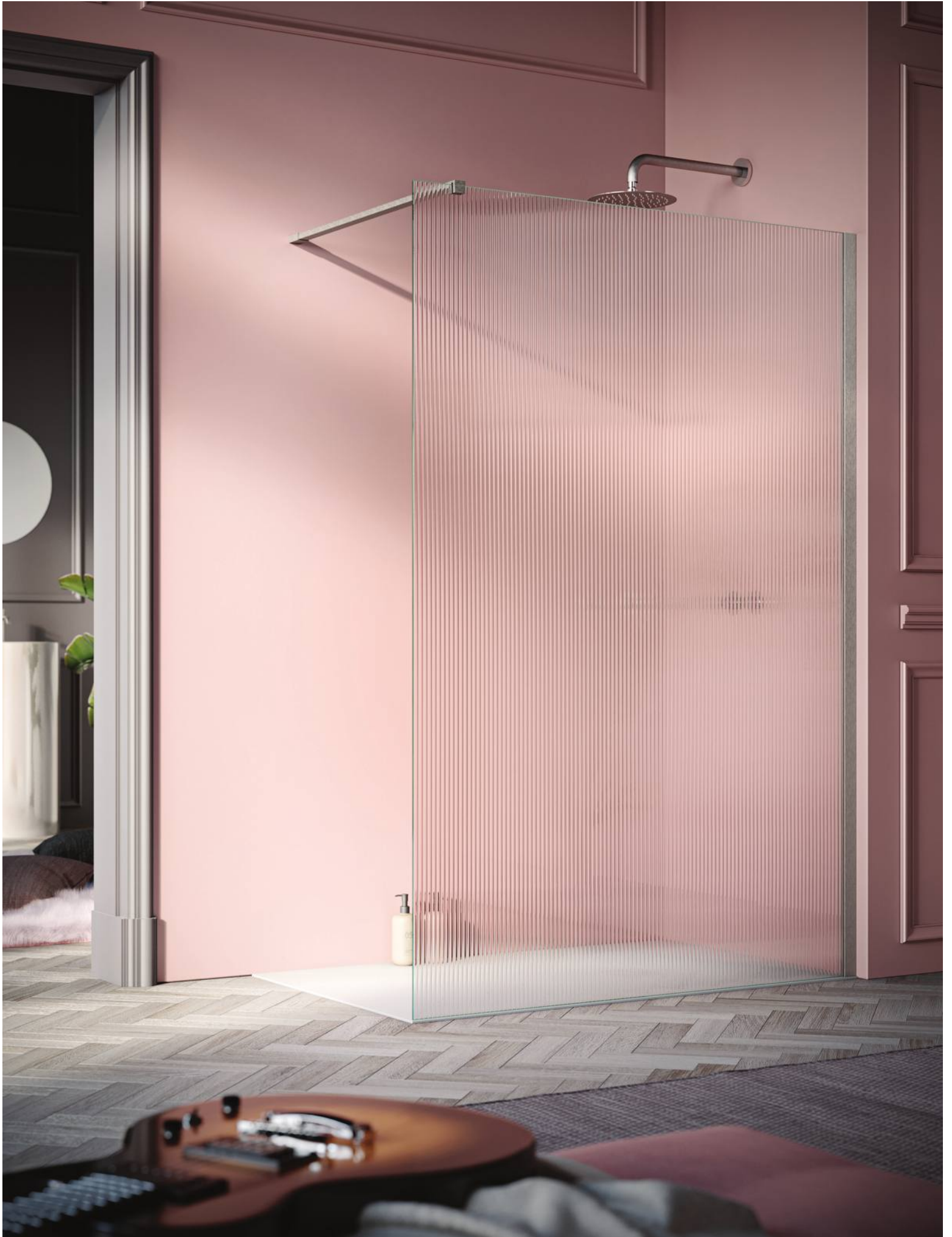













#### **DEFLETTORE PER OPEN**

Per chiunque abbia il desiderio di creare una zona più raccolta all'interno della propria doccia Open, è disponibile un pratico deflettore con vetro da 8mm ruotabile da 0° a 270°. La rotazione è molto importante per mantenere l'accesso all'interno della doccia sempre ampio ed essere messo in posizione solamente nel momento del bisogno.

#### **DEFLECTOR FOR OPEN**

*For anyone wishing to create a more enclosed area within their Open shower, a practical deflector is available with 8mm glass, rotatable from 0° to 270°. This rotation is essential to keep access to the shower spacious and to position the deflector only when needed.*







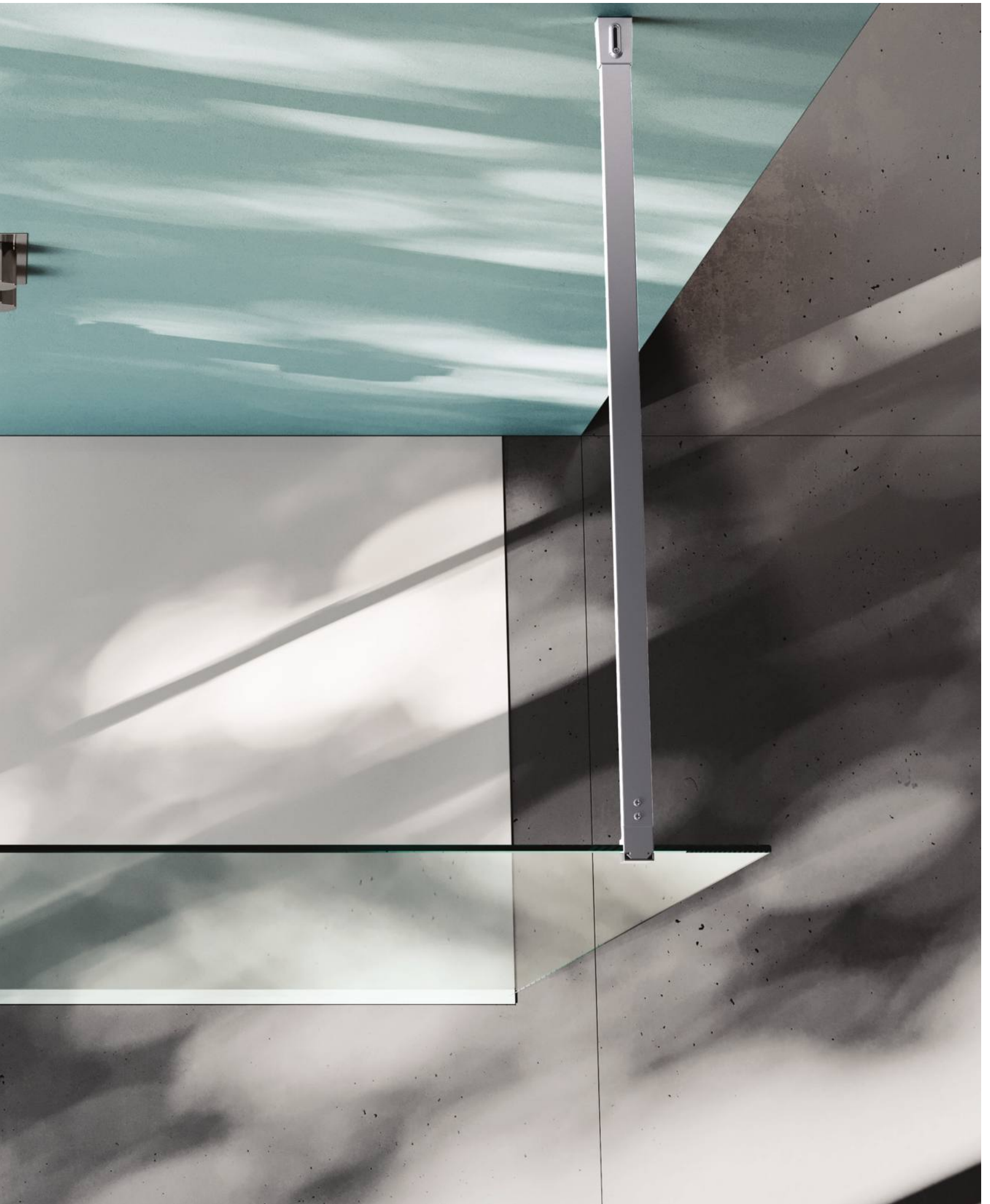





### **MENSOLA CONFIGURABILE**

Open 8 Mensola mette a disposizione del cliente la possibilità di configurare gli elementi da predisporre all'interno del supporto del prodotto. La mensola oltre a contenere questi oggetti, è stata studiata per essere essa stessa l'elemento portante del vetro, dando stabilità e resistenza.

Tra gli elementi disponibili è possibile scegliere tra dosasapone, mensole di appoggio ed elementi contenitivi.

### **CONFIGURABLE SHELF**

*The Open 8 Shelf allows customers to configure elements to include within the product's support. Besides holding items, the shelf is designed to serve as the main support structure for the glass, providing stability and durability. Available elements include soap dispensers, storage shelves, and various container options.*













#### **PORTA DI CHIUSURA**

La serie Open prevede la possibilità di installare su Open 8, Open 8, Open 8 Mensola e Open 8 Screen, una porta di chiusura per evitare la fuoriuscita di schizzi d'acqua o, in generale, per creare maggiore riservatezza ed intimità.

La porta, potendo essere installata in qualsiasi momento, anche successivo a quello di installazione dell'elemento principale, verrà realizzata su misura, in modo da adattarsi al meglio alla propria zona bagno.

La porta è progettata per potersi aprire sia verso l'interno della zona doccia, sia verso l'esterno, in modo da essere completamente adattabile ad ogni situazione.

#### **CLOSURE DOOR**

*The Open series offers an optional closure door for models such as Open 8, Open 8 Mensola, and Open 8 Screen to prevent water splashes and enhance privacy and intimacy. This door can be installed at any time, even after the main element is in place, and is custom-made to perfectly fit your bathroom space. The door is designed to open both inward into the shower area and outward, making it fully adaptable to any situation.*



#### **KT4900 / KIT PALO PAVIMENTO-SOFFITTO**

Se l'installazione della doccia avesse grandi criticità e numerosi ostacoli che non rendono possibile l'utilizzo di nessun sostegno alternativo, la serie Open prevede la possibilità di acquistare il Kit Palo-Pavimento. Il fissaggio di questo elemento sarà esclusivamente sul soffitto, liberando l'utente da ogni vincolo. L'optional è anche adatto a chiunque voglia dare al suo prodotto un'estetica ultra moderna e minimale.

#### **KT4900 / FLOOR-CEILING POLE KIT**

*If the shower installation faces significant challenges and multiple obstacles, making alternative supports unfeasible, the Open series offers the Floor-to-Ceiling Pole Kit. This element is fixed solely to the ceiling, freeing the user from any other constraints. This optional feature is also ideal for anyone looking to give their product an ultra-modern and minimalist aesthetic.*



#### **KT4004 / ZANCA A SOFFITTO**

La serie Open prevede una zanca di sostegno per il vetro da fissare al soffitto. A differenza del Kit Palo-Pavimento KT4900, è possibile ordinare l'accessorio in qualsiasi momento e sostituirlo alla staffa di sostegno standard. È sempre importante verificare la possibilità di installare l'optional per non incorrere in problemi durante la fase di montaggio.

#### **KT4004 / CEILING BRACKET**

*The Open series includes a support bracket for ceiling-mounted glass. Unlike the KT4900 Floor-to-Ceiling Post Kit, this accessory can be ordered at any time and used as a replacement for the standard support bracket. It is always important to verify the feasibility of installing this optional component to avoid issues during assembly.*

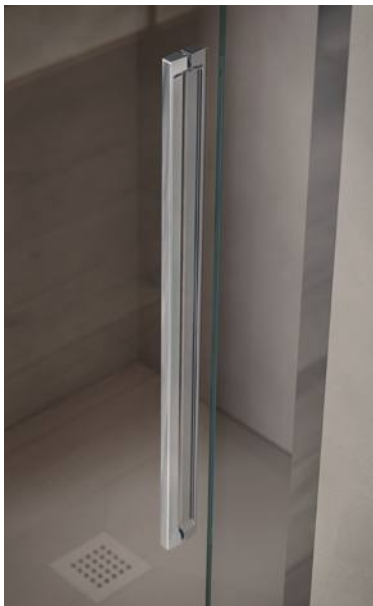

**Maniglia B01 580mm**

Disponibile optional per Open 8 Scorrevole. Da richiedere al momento dell'ordine

**Handle B01 580mm**

Available as an option for Open 8 Sliding. Must be requested at the time of order.

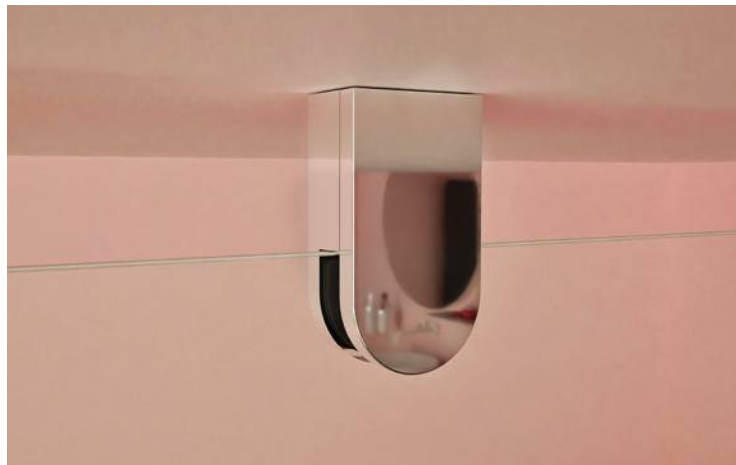

OPTIONAL	COD.		[€]
Supporto ferma vetro a soffitto	KT1006	CRO-L91-L96	85,00
Ceiling-mounted glass holder support		DOLCEVITA	110,00



**KT4710 / ZANCA AD L PICCOLA**

L'ultima tipologia di staffe di sostegno per la serie Open è quella ad L. Una piccola e robusta staffa disegnata per mimetizzarsi nel proprio spazio bagno e dare alla tua parete vetro, l'impressione di fluttuare sul pavimento, senza alcun tipo di sostegno.

Abbiamo previsto due misure di questa zanca, in modo da trovare sempre l'accessorio che meglio si adatta alle dimensioni della propria parete vetro Open.

La zanca ad L piccola misura 185\*155mm.

**KT4710 / SMALL L-SHAPED BRACKET**

The latest type of support bracket in the Open series is the L-bracket. This compact and sturdy bracket is designed to blend seamlessly into the bathroom space, giving your glass wall the impression of floating above the floor without visible support.

We offer two sizes of this bracket to ensure the best fit for your Open glass wall dimensions. The small L-bracket measures 185x155mm.



**KT4720 / ZANCA AD L GRANDE**

L'ultima tipologia di staffe di sostegno per la serie Open è quella ad L. Una piccola e robusta staffa disegnata per mimetizzarsi nel proprio spazio bagno e dare alla tua parete vetro, l'impressione di fluttuare sul pavimento, senza alcun tipo di sostegno.

Abbiamo previsto due misure di questa zanca, in modo da trovare sempre l'accessorio che meglio si adatta alle dimensioni della propria parete vetro Open.

La zanca ad L grande misura 405\*205mm.

**KT4720 / LARGE L-SHAPED BRACKET**

The latest type of support bracket in the Open series is the L-bracket. This compact and sturdy bracket is designed to blend seamlessly into the bathroom space, giving your glass wall the impression of floating above the floor without any visible support.

We offer two sizes of this bracket to ensure the best fit for your Open glass wall dimensions. The large L-bracket measures 405x205mm.







- > Parete doccia senza telaio
- > Vetro temperato 6mm o 8mm
- > Trattamento anticalcare StarClean di serie incluso nel prezzo
- > Estensibilità e regolazione fuori squadra del muro fino a 1,5/2cm
- > Possibilità di configurazione barra porta accessori
- > Stampa digitale disponibile su tutti i vetri piani TR

- > Shower wall without frame
- > 6mm or 8mm tempered glass
- > StarClean anti-limescale treatment included in the price
- > Wall adjustment and out-of-square compensation up to 1,5/2cm
- > Option to configure accessory bar
- > Digital printing available on all flat glasses TR

# OPEN

## PRODOTTI DELLA SERIE / PRODUCTS OF THE SERIES

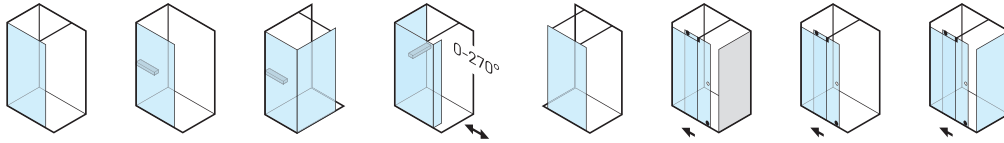

60-61  
62-63

64-65

66-67

Vedi modelli  
See models

68-69

70-71

70-71

70-71

## PROFILI / PROFILES

### STANDARD

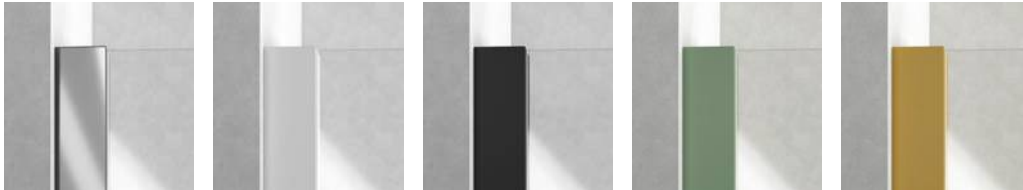

**ULU / CRO**

Brillianto Lucido  
Brilliant Polished

**L91**

Bianco Opaco  
Matte White

**L96**

Nero Opaco  
Matte Black

**L73**

Sage Opaco  
Matte Sage

**L86**

Ambra Opaco  
Matte Ambra

### DOLCEVITA



**SNK**

Nickel Spazzolato  
Brushed Nickel

**AL4**

Bronzo Spazzolato  
Brushed Bronze

**AL5**

Oro Rosa Lucido  
Polished Rose Gold

**GLB**

Oro Spazzolato  
Brushed Gold

**GLP**

Oro Lucido  
Polished Gold

**GMB**

Gun Metal Spazzolato  
Brushed Gun Metal

## VETRO / GLASS

### STANDARD



**TR**

Trasparente  
Transparent

**TG**

Trasparente Grigio  
Transparent Grey

**GS**

Satinato Grigio  
Satin Grey

**RF**

Fascia H.100cm  
Band H.100cm

### ON DEMAND



**ST**

Stampato  
Printed

**TE**

Extrachiario  
Extra Clear

**AS**

Satinato  
Satin

**SY**

Specchio  
Mirror

**TC**

Cannettato  
Fluted

**TN**

Sfumato Nuvola  
Nuvola Gradient

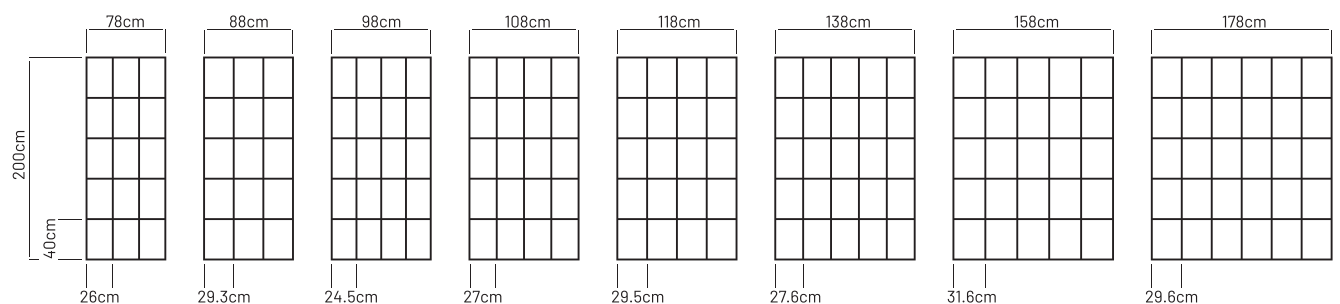

Proporzioni stampa  
digitale DG "Griglia"  
DG "Griglia" digital print  
proportions

# OPEN 6

PARETE PRINCIPALE  
MAIN WALL



Per istruzioni di montaggio  
e ricambi inquadra il codice QR  
For assembly instructions  
and spare parts, scan the QR code



**H. 200cm**  
**SP. 6mm**

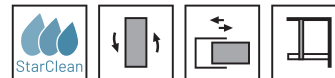

Parete vetro con area di accesso totalmente libera, con la sola presenza del profilo verticale e di un braccetto di sostegno a dare stabilità al prodotto. Modello adatto per chi predilige un'estetica minimale e moderna.

*Glass wall with a completely open access area, featuring only a vertical profile and a support arm to provide stability to the product. This model is ideal for those who prefer a minimalistic and modern aesthetic.*

**CONFIGURAZIONE AD ANGOLO**  
**CORNER CONFIGURATION**

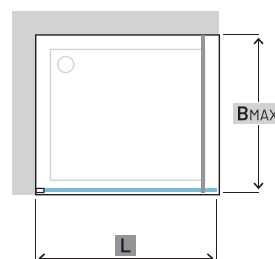

**COMBINAZIONI**  
**COMBINATIONS**

Non è possibile realizzare COMBINAZIONI.  
*It is not possible to create COMBINATIONS.*

## ORIENTAMENTO E POSSIBILI COMBINAZIONI / ORIENTATION AND POSSIBLE CONFIGURATIONS

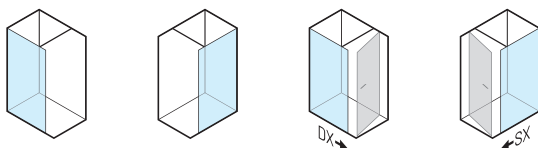

### PROFILI / PROFILES

STANDARD	
ULU	Brillantato Lucido Brilliant Polished
L91	Bianco Opaco Matte White
L96	Nero Opaco Matte Black

DOLCEVITA	
SNK	Nickel Spazzolato Nickel Brushed
AL4	Bronzo Spazzolato Brushed Bronze
AL5	Oro Rosa Lucido Polished Rose Gold
GLB	Oro Spazzolato Brushed Gold
GLP	Oro Lucido Polished Gold
GMB	Gun Metal Spazzolato Brushed Gun Metal

### VETRO / GLASS

STANDARD		
TR	Trasparente Transparent	
ON DEMAND		
TE	Extrachiaro Extra Clear	TR +25%
TG	Trasparente Grigio Transparent Grey	TR +25%
AS	Satinato Satin	TR +25%
GS	Satinato Grigio Satin Grey	TR +25%
RF	Fascia H.100cm Band H.100cm	TR +25%
TC	Cannettato Fluted	TR +50%
SY	Specchio Mirror <sup>4</sup>	TR +50%

## PARETE / PANEL

L [cm]	COD.	B MAX [cm]	[dm <sup>3</sup> ]	[kg]	[Pcs]	V	ULU	L96	L91	DOLCEVITA
76,5-78	B4091	120	120	34	1	TR	465,00			605,00
78,5-80	B4001						465,00			605,00
86,5-88	B4093	120	135	39	1	TR	490,00			635,00
88,5-90	B4003						490,00			635,00
96,5-98	B4095	120	150	44	1	TR	515,00			670,00
98,5-100	B4005						515,00			670,00
116,5-118	B4097	120	181	54	1	TR	565,00			735,00
118,5-120	B4007						565,00			735,00
136,5-138	B4099	120	244	64	1	TR	625,00			815,00
138,5-140	B4009						625,00			815,00

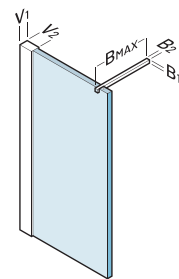

L	Value
V1	18mm
V2	40mm
B1	15mm
B2	30mm
BMAX	120cm

## PORTA / DOOR

H. 200cm  
SP. 6mm



L1 [cm]	COD.	C [cm]	[dm <sup>3</sup> ]	[kg]	[Pcs]	V	ULU	L96	L91	DOLCEVITA
70-85,9	B478X	62-78	107	25	1	TR	610,00			795,00
86-100	B478Y	78-92	120	32	1	TR	660,00			860,00

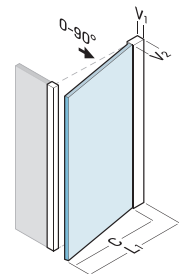

L1	Value
V1	32mm
V2	38mm

Porta battente per chiusura in configurazione ad angolo di Open 6.  
Estensibilità della porta battente 2cm su profilo verticale a muro.  
Hinged door for corner configuration for Open 6.  
Extendibility of the hinged door by 2 cm on the vertical wall-mounted profile.

SU MISURA/CUSTOM	PARETE WALL	[€]	PORTA DOOR	[€]
Altezza/Height <sup>1</sup>	10-220cm	+20%	110-220cm	+20%
Larghezza/Width <sup>2</sup>	35-160cm	+20%	50-100cm	+20%
Altezza/Height Larghezza/Width <sup>2</sup>	10-220cm 35-160cm	+20%	110-220cm 50-100cm	+20%
Altre forme Other shapes <sup>2</sup>		+30%		+30%

OPTIONAL	[cm]	COD.	[€]
Zanca a soffitto Ceiling bracket	-	KT4004 (P.54)	50,00 DOLCEVITA 65,00
Zanca L piccola Small L-shaped bracket <sup>3</sup>	185x155	KT4710 (P.55)	185,00 DOLCEVITA 245,00
Zanca L grande Big L-shaped bracket <sup>3</sup>	405x205	KT4720 (P.55)	210,00 DOLCEVITA 275,00
Zanca snodata Articulated bracket <sup>3</sup>	L.1120	KT1400 (P.34)	100,00 DOLCEVITA 130,00
Kit sostegno 1500 1500 support kit <sup>3</sup>	L.1500	KT4091-1500	70,00 DOLCEVITA 95,00

<sup>1</sup> Dal prezzo della misura di riferimento / From the price of selected size

<sup>2</sup> Dal prezzo della misura superiore / From the price of the larger size

<sup>3</sup> Da richiedere al momento dell'ordine / To be requested at the time of order

<sup>4</sup> Fattibilità dopo verifica tecnica / Feasibility after technical verification

DISPONIBILITA' A MAGAZZINO / STOCK AVAILABILITY

1/2 Settimane/Weeks

2/3 Settimane/Weeks

3/4 Settimane/Weeks

# OPEN 8

PARETE PRINCIPALE  
MAIN WALL



Per istruzioni di montaggio  
e ricambi inquadra il codice QR  
For assembly instructions  
and spare parts, scan the QR code



**H. 200cm**  
**SP. 8mm**

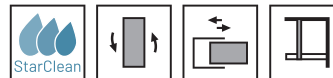

Parete vetro con area di accesso totalmente libera, con la sola presenza del profilo verticale e di un braccetto di sostegno a dare stabilità al prodotto. Modello adatto per chi predilige un'estetica minimale e moderna.

*Glass wall with a completely open access area, featuring only a vertical profile and a support arm to provide stability to the product. This model is ideal for those who prefer a minimalistic and modern aesthetic.*

**CONFIGURAZIONE AD ANGOLO**  
**CORNER CONFIGURATION**

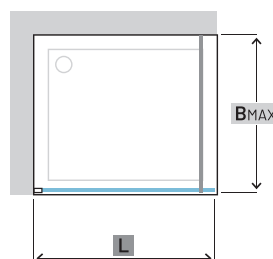

**COMBINAZIONI**  
**COMBINATIONS**

Consultare la pagina COMBINAZIONI per le opzioni disponibili.  
Check the COMBINATIONS page for the available options.

## ORIENTAMENTO E POSSIBILI COMBINAZIONI / ORIENTATION AND POSSIBLE CONFIGURATIONS

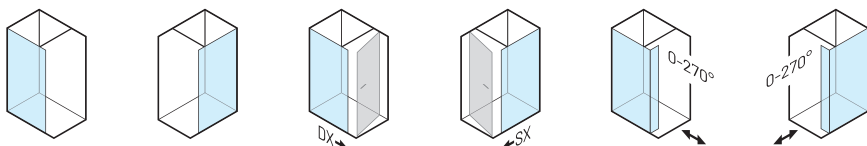

### PROFILI / PROFILES

STANDARD	
ULU	Brillantato Lucido Brilliant Polished
L91	Bianco Opaco Matte White
L96	Nero Opaco Matte Black

ATELIER	
L73	Sage Opaco Matte Sage
L86	Ambra Opaco Matte Ambra

DOLCEVITA	
SNK	Nickel Spazzolato Nickel Brushed
AL4	Bronzo Spazzolato Brushed Bronze
AL5	Oro Rosa Lucido Polished Rose Gold
GLB	Oro Spazzolato Brushed Gold
GLP	Oro Lucido Polished Gold
GMB	Gun Metal Spazzolato Brushed Gun Metal

### VETRO / GLASS

STANDARD	
TR	Trasparente Transparent
TG	Trasparente Grigio Transparent Grey
GS	Grigio Satinato Satin Grey
RF	Fascia H.100cm Band H.100cm

ON DEMAND		
TE	Extrachiaro Extra Clear	TR +25%
AS	Satinato Satin	TR +25%
SY	Specchio Mirror *	TR +50%
TN	Sfumato Nuvola Nuvola Gradient	TR +50%

## PARETE / PANEL

L [cm]	COD.	B MAX [cm]	[dm <sup>3</sup> ]	[kg]	[Pcs]	V	ULU	L96	L91	ATELIER	DOLCEVITA
76,5-78	B4081	120	120	34	1	TR	640,00			640,00	830,00
78,5-80	B4051					TG-GS-RF	800,00			800,00	1.040,00
86,5-88	B4082	120	135	39	1	TR	725,00			725,00	945,00
88,5-90	B4052					TG-GS-RF	905,00			905,00	1.175,00
96,5-98	B4083	120	150	44	1	TR	725,00			725,00	945,00
98,5-100	B4053					TG-GS-RF	905,00			905,00	1.175,00
116,5-118	B4084	120	181	54	1	TR	790,00			790,00	1.025,00
118,5-120	B4054					TG-GS-RF	990,00			990,00	1.285,00
136,5-138	B4085	120	244	64	1	TR	855,00			855,00	1.110,00
138,5-140	B4055					TG-GS-RF	1.070,00			1.070,00	1.390,00
156,5-158	B4086	120	270	75	1	TR	920,00			920,00	1.195,00
158,5-160	B4056					TG-GS-RF	1.150,00			1.150,00	1.495,00
176,5-178	B4087	120	300	83	1	TR	985,00			985,00	1.280,00
178,5-180	B4057					TG-GS-RF	1.230,00			1.230,00	1.600,00

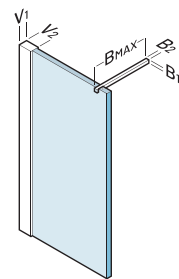

L
V1 17mm
V2 40mm
B1 15mm
B2 30mm
BMAX 120cm

## PORTA / DOOR

H. 200cm  
SP. 6mm



L1 [cm]	COD.	C [cm]	[dm <sup>3</sup> ]	[kg]	[Pcs]	V	ULU	L96	L91	ATELIER	DOLCEVITA
70-85,9	B478X	62-78	107	25	1	TR	610,00			610,00	795,00
						TG-GS-RF	765,00			765,00	995,00
86-100	B478Y	78-92	120	32	1	TR	660,00			660,00	860,00
						TG-GS-RF	825,00			825,00	1.075,00

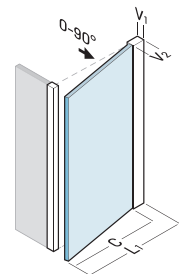

L1
V1 32mm
V2 38mm

Porta battente per chiusura in configurazione ad angolo di Open 8. Estensibilità della porta battente 2cm su profilo verticale a muro.  
Hinged door for corner configuration for Open 8. Extensibility of the hinged door by 2 cm on the vertical wall-mounted profile.

## DEFLETTORE / DEFLECTOR

H. 200cm  
SP. 8mm

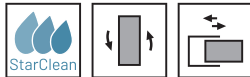

L2 [cm]	COD.	C [cm]	[dm <sup>3</sup> ]	[kg]	[Pcs]	V	ULU	L96	L91	ATELIER	DOLCEVITA
30	B4771	-	50	35	1	TR	400,00			400,00	520,00
						TG-GS-RF	500,00			500,00	650,00
40	B4772	-	50	35	1	TR	425,00			425,00	555,00
						TG-GS-RF	530,00			530,00	690,00
50	B4773	-	50	35	1	TR	450,00			450,00	585,00
						TG-GS-RF	565,00			565,00	735,00



L2
V1 31mm
V2 40mm



SU MISURA/CUSTOM	PARETE WALL	[€]	PORTA DOOR	DEFLETTORE DEFLECTOR	[€]
Altezza/Height <sup>1</sup>	80-245cm <sup>4</sup>	+20%	110-220cm	100-220cm	+20%
Larghezza/Width <sup>2</sup>	15-240cm <sup>4</sup>	+20%	50-100cm	15-60cm	+20%
Altezza/Height	80-245cm <sup>4</sup>	+20%	110-220cm	100-220cm	+20%
Larghezza/Width <sup>2</sup>	15-240cm <sup>4</sup>	+20%	50-100cm	15-60cm	+20%
Altre forme Other shapes <sup>2</sup>		+30%			+30%

OPTIONAL	[mm]	COD.	[€]
Zanca a soffitto Ceiling bracket	-	KT4004 (P.54)	50,00
Zanca L piccola Small L-shaped bracket <sup>3</sup>	185x155	KT4710 (P.55)	185,00
Zanca L grande Big L-shaped bracket <sup>3</sup>	405x205	KT4720 (P.55)	210,00
Zanca snodata Articulated bracket <sup>3</sup>	L.1120	KT1400 (P.34)	100,00
Kit sostegno 1200 ricambio 1200 support kit replacement <sup>3</sup>	L.1200	RIC1809	105,00
Kit palo pavimento-soffitto Floor-ceiling pole kit <sup>3</sup>	min.2670 max.2720	KT4900 (P.54)	290,00
Kit sostegno palo Pole support kit <sup>3</sup>	750-850	KTO (P.34)	170,00

<sup>1</sup> Dal prezzo della misura di riferimento / From the price of selected size

<sup>2</sup> Dal prezzo della misura superiore / From the price of the larger size

<sup>3</sup> Da richiedere al momento dell'ordine / To be requested at the time of order

<sup>4</sup> Fattibilità dopo verifica tecnica / Feasibility after technical verification

DISPONIBILITA' A MAGAZZINO / STOCK AVAILABILITY

1/2 Settimane/Weeks

2/3 Settimane/Weeks

3/4 Settimane/Weeks

# OPEN 8 MENSOLA

PARETE PRINCIPALE CON MENSOLA  
MAIN WALL WITH SHELF



Per istruzioni di montaggio  
e ricambi inquadra il codice QR  
For assembly instructions  
and spare parts, scan the QR code



H. 200cm  
SP. 8mm

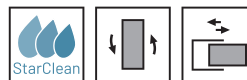

Parete vetro con area di accesso totalmente libera, con la sola presenza del profilo verticale e di una mensola interna personalizzabile e configurabile a dare stabilità al prodotto. Modello adatto per chi predilige un'estetica minimale e moderna e necessita di una zona di appoggio e contenimento.

*Glass wall with a completely open access area, featuring only a vertical profile and a customizable, configurable internal shelf to provide stability to the product. This model is ideal for those who prefer a minimalistic and modern aesthetic and require a support and storage area.*

## CONFIGURAZIONE AD ANGOLO CORNER CONFIGURATION

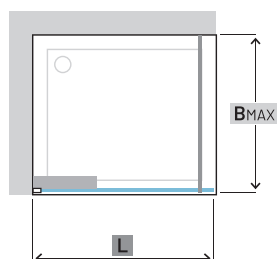

### COMBINAZIONI COMBINATIONS

Non è possibile realizzare COMBINAZIONI.  
It is not possible to create COMBINATIONS.

## ORIENTAMENTO E POSSIBILI COMBINAZIONI / ORIENTATION AND POSSIBLE CONFIGURATIONS

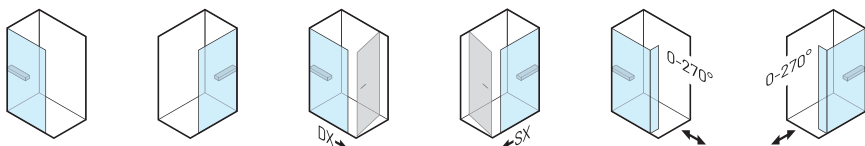

## PROFILI / PROFILES

STANDARD	
ULU	Brillantato Lucido Brilliant Polished
L91	Bianco Opaco Matte White
L96	Nero Opaco Matte Black

ATELIER	
L73	Sage Opaco Matte Sage
L86	Ambra Opaco Matte Ambra

DOLCEVITA	
SNK	Nickel Spazzolato Nickel Brushed
AL4	Bronzo Spazzolato Brushed Bronze
AL5	Oro Rosa Lucido Polished Rose Gold
GLB	Oro Spazzolato Brushed Gold
GLP	Oro Lucido Polished Gold
GMB	Gun Metal Spazzolato Brushed Gun Metal

## VETRO / GLASS

STANDARD		
TR	Trasparente Transparent	
TG	Trasparente Grigio Transparent Grey	
GS	Grigio Satinato Satin Grey	
RF	Fascia H.100cm Band H.100cm	
ON DEMAND		
TE	Extrachiaro Extra Clear	TR +25%
AS	Satinato Satin	TR +25%
SY	Specchio Mirror *	TR +50%
TN	Sfumato Nuvola Nuvola Gradient	TR +50%

## PARETE / PANEL

L [cm]	COD.	B MAX [cm]	[dm <sup>3</sup> ]	[kg]	[Pcs]	V	ULU	L96	L91	ATELIER	DOLCEVITA
76,5-78	B4781	-	145	34	1	TR		750,00		750,00	975,00
78,5-80	B4751	-				TG-GS-RF		940,00		940,00	1.220,00
86,5-88	B4782	-	165	39	1	TR		830,00		830,00	1.080,00
88,5-90	B4752	-				TG-GS-RF		1.040,00		1.040,00	1.350,00
96,5-98	B4783	-	183	44	1	TR		830,00		830,00	1.080,00
98,5-100	B4753	-				TG-GS-RF		1.040,00		1.040,00	1.350,00
116,5-118	B4784	-	201	54	1	TR		890,00		890,00	1.155,00
118,5-120	B4754	-				TG-GS-RF		1.115,00		1.115,00	1.450,00
136,5-138	B4785	-	220	64	1	TR		995,00		995,00	1.295,00
138,5-140	B4755	-				TG-GS-RF		1.245,00		1.245,00	1.620,00
156,5-158	B4786	-	280	75	1	TR		1.065,00		1.065,00	1.385,00
158,5-160	B4756	-				TG-GS-RF		1.330,00		1.330,00	1.730,00
176,5-178	B4787	-	310	83	1	TR		1.270,00		1.270,00	1.650,00
178,5-180	B4757	-				TG-GS-RF		1.590,00		1.590,00	2.065,00

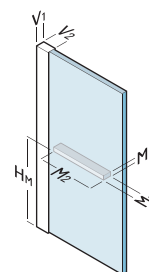

L
V <sub>1</sub> 17mm
V <sub>2</sub> 40mm
M <sub>1</sub> 94mm
M <sub>2</sub> 596mm
M <sub>3</sub> 40mm
H <sub>M</sub> 100cm

## PORTA / DOOR

H. 200cm  
SP. 6mm



L1 [cm]	COD.	B MAX [cm]	[dm <sup>3</sup> ]	[kg]	[Pcs]	V	ULU	L96	L91	ATELIER	DOLCEVITA
70-85,9	B478X	62-78	107	25	1	TR		610,00		610,00	795,00
						TG-GS-RF		765,00		765,00	995,00
86-100	B478Y	78-92	120	32	1	TR		660,00		660,00	860,00
						TG-GS-RF		825,00		825,00	1.075,00

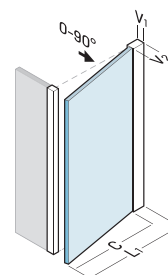

L1
V <sub>1</sub> 32mm
V <sub>2</sub> 38mm

Porta battente per chiusura in configurazione ad angolo di Open 8. Estensibilità della porta battente 2cm su profilo verticale a muro.  
Hinged door for corner configuration for Open 8. Extensibility of the hinged door by 2 cm on the vertical wall-mounted profile.

## DEFLETTORE / DEFLECTOR

H. 200cm  
SP. 8mm

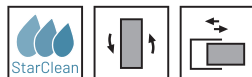

L2 [cm]	COD.	C [cm]	[dm <sup>3</sup> ]	[kg]	[Pcs]	V	ULU	L96	L91	ATELIER	DOLCEVITA
30	B4771	-	50	35	1	TR		400,00		400,00	520,00
						TG-GS-RF		500,00		500,00	650,00
40	B4772	-	50	35	1	TR		425,00		425,00	555,00
						TG-GS-RF		530,00		530,00	690,00
50	B4773	-	50	35	1	TR		450,00		450,00	585,00
						TG-GS-RF		565,00		565,00	735,00



L2
V <sub>1</sub> 31mm
V <sub>2</sub> 40mm



SU MISURA/CUSTOM	PARETE WALL	[€]	PORTA DOOR	DEFLETTORE DEFLECTOR	[€]
Altezza/Height <sup>1</sup>	110-220cm	+20%	110-220cm	100-220cm	+20%
Larghezza/Width <sup>2</sup>	50-180cm	+20%	50-100cm	15-60cm	+20%
Altezza/Height	110-220cm	+20%	110-220cm	100-220cm	+20%
Larghezza/Width <sup>2</sup>	50-180cm	+20%	50-100cm	15-60cm	+20%
Altre forme Other shapes <sup>2</sup>		+30%			+30%

OPTIONAL	[mm]	COD.	[€]
Zanca a soffitto Ceiling bracket	-	KT4004 (P.54)	50,00
Zanca L piccola Small L-shaped bracket <sup>3</sup>	185x155	KT4710 (P.55)	185,00
Zanca L grande Big L-shaped bracket <sup>3</sup>	405x205	KT4720 (P.55)	210,00
Zanca snodata Articulated bracket <sup>3</sup>	L.1120	KT1400 (P.34)	100,00
Kit sostegno 1200 ricambio 1200 support kit replacement <sup>3</sup>	L.1200	RIC1809	105,00
Kit palo pavimento-soffitto Floor-ceiling pole kit <sup>3</sup>	min.2670 max.2720	KT4900 (P.54)	290,00
Kit sostegno palo Pole support kit <sup>3</sup>	750-850	KTO (P.34)	170,00

DISPONIBILITA' A MAGAZZINO / STOCK AVAILABILITY

1/2 Settimane/Weeks 2/3 Settimane/Weeks 3/4 Settimane/Weeks

<sup>1</sup> Dal prezzo della misura di riferimento / From the price of selected size

<sup>2</sup> Dal prezzo della misura superiore / From the price of the larger size

<sup>3</sup> Da richiedere al momento dell'ordine / To be requested at the time of order

<sup>4</sup> Fattibilità dopo verifica tecnica / Feasibility after technical verification

# OPEN 8 MENSOLA

PARETE SECONDARIA CON MENSOLA  
SECONDARY WALL WITH SHELF



Per istruzioni di montaggio  
e ricambi inquadra il codice QR  
For assembly instructions  
and spare parts, scan the QR code



H. 200cm  
SP. 8mm

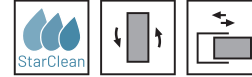

Parete vetro con area di accesso totalmente libera, con la presenza del profilo verticale e di una mensola interna personalizzabile e configurabile a dare stabilità al prodotto. Modello da configurare insieme ad una parete Open 8, non utilizzabile individualmente.

*Glass wall with a completely open access area, featuring only a vertical profile and a customizable, configurable internal shelf to provide stability to the product. This model is designed to be configured alongside an Open 8 wall and cannot be used individually.*

## CONFIGURAZIONE AD ANGOLO CORNER CONFIGURATION

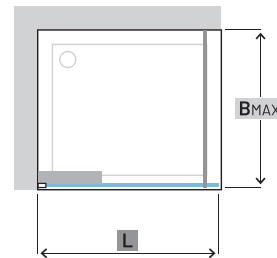

## COMBINAZIONI COMBINATIONS

Non è possibile realizzare COMBINAZIONI.  
It is not possible to create COMBINATIONS.

## ORIENTAMENTO E POSSIBILI COMBINAZIONI / ORIENTATION AND POSSIBLE CONFIGURATIONS

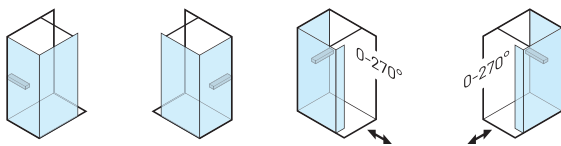

## PROFILI / PROFILES

STANDARD	
ULU	Brillantato Lucido Brilliant Polished
L91	Bianco Opaco Matte White
L96	Nero Opaco Matte Black

ATELIER	
L73	Sage Opaco Matte Sage
L86	Ambra Opaco Matte Ambra

DOLCEVITA	
SNK	Nickel Spazzolato Nickel Brushed
AL4	Bronzo Spazzolato Brushed Bronze
AL5	Oro Rosa Lucido Polished Rose Gold
GLB	Oro Spazzolato Brushed Gold
GLP	Oro Lucido Polished Gold
GMB	Gun Metal Spazzolato Brushed Gun Metal

## VETRO / GLASS

STANDARD		
TR	Trasparente Transparent	
TG	Trasparente Grigio Transparent Grey	
GS	Grigio Satinato Satin Grey	
RF	Fascia H.100cm Band H.100cm	
ON DEMAND		
TE	Extrachiaro Extra Clear	TR +25%
AS	Satinato Satin	TR +25%
SY	Specchio Mirror *	TR +50%
TN	Sfumato Nuvola Nuvola Gradient	TR +50%

## PARETE SECONDARIA / SECONDARY PANEL

L2 [cm]	COD.	C [cm]	[dm3]	[kg]	[Pcs]	V	ULU L96 L91	ATELIER	DOLCEVITA
78,5-80	B4745	-	116	44	1	TR TG-GS-RF	685,00 855,00	685,00 855,00	1.155,00 1.450,00
88,5-90	B4746	-	131	49	1	TR TG-GS-RF	755,00 945,00	755,00 945,00	1.280,00 1.600,00
98,5-100	B4747	-	145	54	1	TR TG-GS-RF	755,00 945,00	755,00 945,00	1.280,00 1.600,00

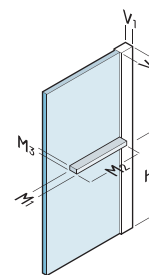

L	Value
V1	17mm
V2	40mm
M1	94mm
M2	596mm
M3	40mm
HM	100cm

## PARETE / PANEL

H. 200cm  
SP. 8mm

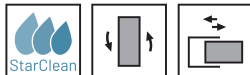

L [cm]	COD.	B MAX [cm]	[dm3]	[kg]	[Pcs]	V	ULU L96 L91	ATELIER	DOLCEVITA
76,5-78	B4081	120	120	34	1	TR	640,00	640,00	830,00
78,5-80	B4051	120	120	34	1	TG-GS-RF	800,00	800,00	1.040,00
86,5-88	B4082	120	135	39	1	TR	725,00	725,00	945,00
88,5-90	B4052	120	135	39	1	TG-GS-RF	905,00	905,00	1.175,00
96,5-98	B4083	120	150	44	1	TR	725,00	725,00	945,00
98,5-100	B4053	120	150	44	1	TG-GS-RF	905,00	905,00	1.175,00
116,5-118	B4084	120	181	54	1	TR	790,00	790,00	1.025,00
118,5-120	B4054	120	181	54	1	TG-GS-RF	990,00	990,00	1.285,00
136,5-138	B4085	120	244	64	1	TR	855,00	855,00	1.110,00
138,5-140	B4055	120	244	64	1	TG-GS-RF	1.070,00	1.070,00	1.390,00
156,5-158	B4086	120	270	75	1	TR	920,00	920,00	1.195,00
158,5-160	B4056	120	270	75	1	TG-GS-RF	1.150,00	1.150,00	1.495,00
176,5-178	B4087	120	300	83	1	TR	985,00	985,00	1.280,00
178,5-180	B4057	120	300	83	1	TG-GS-RF	1.230,00	1.230,00	1.600,00

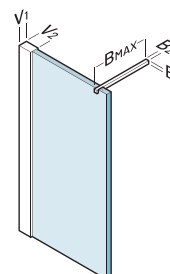

L	Value
V1	17mm
V2	40mm
B1	15mm
B2	30mm
BMAX	120cm

## ACCESSORI / ACCESSORIES



5146-S



5147-S



5148-S



5152-S



5153-S

L*P*H [mm]	COD.	DESCRIZIONE / DESCRIPTION.	[dm3]	[kg]	[Pcs]	.09	.18	.29	.80	.73	.86
85*85*105	5146-S	Porta spazzolini - Toothbrush holder	22	0,100	1		45,00		40,00		60,00
130*85*60	5147-S	Portasapone - Soap dish	25	0,120	1		45,00		40,00		60,00
205*85*60	5148-S	Portaoggetti - Storage compartment	35	0,200	1		50,00		45,00		65,00
90*85*150	5152-S	Dosasapone - Shelf	52	0,250	1		75,00		-		85,00
290*85*60	5153-S	Mensola d'appoggio - Support shelf	28	0,150	1		45,00		-		-

! Gli accessori in finitura Sage (.73) e Ambra (.86) sono ordinabili solo in abbinamento ad almeno una parete doccia, nello stesso colore scelto e con un unico ordine.  
Nella composizione degli accessori da inserire nella mensola non superare mai la lunghezza totale di 580 mm.  
Accessories in Sage finish (.73) and Amber (.86) can only be ordered in combination with at least one shower enclosure, in the same chosen color, and with a single order.  
When composing the accessories to be placed on the shelf, never exceed a total length of 580 mm.

SU MISURA/CUSTOM	PARETE WALL	[€]	PORTA DOOR	DEFLETTORE DEFLECTOR	[€]
Altezza/Height <sup>1</sup>	110-220cm	+20%	110-220cm	100-220cm	+20%
Larghezza/Width <sup>2</sup>	50-180cm	+20%	50-100cm	15-60cm	+20%
Altezza/Height Larghezza/Width <sup>2</sup>	110-220cm 50-180cm	+20%	110-220cm 50-100cm	100-220cm 15-60cm	+20%
Altre forme Other shapes <sup>2</sup>		+30%			+30%

OPTIONAL	[mm]	COD.	[€]
Zanca a soffitto Ceiling bracket	-	KT4004 (P.54)	CRO-L91-L96 50,00 DOLCEVITA 65,00
Zanca L piccola Small L-shaped bracket <sup>3</sup>	185x155	KT4710 (P.55)	CRO-L91-L96 185,00 DOLCEVITA 245,00
Zanca L grande Big L-shaped bracket <sup>3</sup>	405x205	KT4720 (P.55)	CRO-L91-L96 210,00 ATELIER 210,00 DOLCEVITA 275,00
Zanca snodata Articulated bracket <sup>3</sup>	L.1120	KT1400 (P.34)	ULU-L91-L96 100,00 DOLCEVITA 130,00
Kit sostegno 1200 ricambio 1200 support kit replacement <sup>3</sup>	L.1200	RIC1809	ULU-L91-L96 105,00 ATELIER 105,00 DOLCEVITA 130,00
Kit palo pavimento-soffitto Floor-ceiling pole kit <sup>3</sup>	min.2670 max.2720	KT4900 (P.54)	ULU-L91-L96 290,00 ATELIER 290,00 DOLCEVITA 380,00
Kit sostegno palo Pole support kit <sup>3</sup>	750-850	KTO (P.34)	CRO-L91-L96 130,00 DOLCEVITA 170,00

<sup>1</sup> Dal prezzo della misura di riferimento / From the price of selected size

<sup>2</sup> Dal prezzo della misura superiore / From the price of the larger size

<sup>3</sup> Da richiedere al momento dell'ordine / To be requested at the time of order

<sup>4</sup> Fattibilità dopo verifica tecnica / Feasibility after technical verification

DISPONIBILITA' A MAGAZZINO / STOCK AVAILABILITY

1/2 Settimane/Weeks

2/3 Settimane/Weeks

3/4 Settimane/Weeks

# OPEN 8 SCREEN

PARETE PRINCIPALE  
MAIN WALL



Per istruzioni di montaggio  
e ricambi inquadra il codice QR  
For assembly instructions  
and spare parts, scan the QR code



**H. 200cm**  
**SP. 8mm**

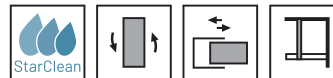

Parete vetro con area di accesso totalmente libera, con la sola presenza di due braccetti di sostegno a dare stabilità al prodotto. Modello adatto per chi predilige un'estetica minimale e moderna.

Glass wall with a completely open access area, featuring only two support arms to provide stability to the product. This model is ideal for those who prefer a minimalistic and modern aesthetic.

CONFIGURAZIONE IN NICCHIA  
NICHE CONFIGURATION

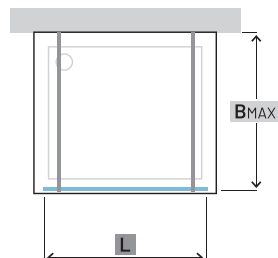

COMBINAZIONI  
COMBINATIONS

Non è possibile realizzare COMBINAZIONI.  
It is not possible to create COMBINATIONS.

## ORIENTAMENTO E POSSIBILI COMBINAZIONI / ORIENTATION AND POSSIBLE CONFIGURATIONS

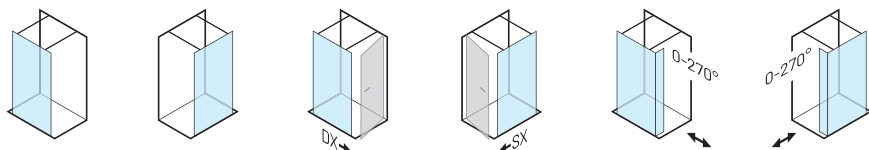

### PROFILI / PROFILES

STANDARD	
CRO	Brillantato Lucido Brilliant Polished
L91	Bianco Opaco Matte White
L96	Nero Opaco Matte Black

DOLCEVITA	
SNK	Nickel Spazzolato Nickel Brushed
AL4	Bronzo Spazzolato Brushed Bronze
AL5	Oro Rosa Lucido Polished Rose Gold
GLB	Oro Spazzolato Brushed Gold
GLP	Oro Lucido Polished Gold
GMB	Gun Metal Spazzolato Brushed Gun Metal

### VETRO / GLASS

STANDARD		
TR	Trasparente Transparent	
TG	Trasparente Grigio Transparent Grey	
GS	Grigio Satinato Satin Grey	
ON DEMAND		
TE	Extrachiario Extra Clear	TR +25%
AS	Satinato Satin	TR +25%
RF	Fascia H.100cm Band H.100cm	TR +25%
SY	Specchio Mirror <sup>4</sup>	TR +50%
TN	Sfumato Nuvola Nuvola Gradient	TR +50%

## PARETE / PANEL

L [cm]	COD.	B MAX [cm]	[dm <sup>3</sup> ]	[kg]	[Pcs]	V	CRO	L96	L91	DOLCEVITA
96	B4073	120	133	42	1	TR		740,00		960,00
						TG-GS		925,00		1.220,00
116	B4075	120	174	52	1	TR		795,00		1.035,00
						TG-GS		995,00		1.305,00
136	B4077	120	246	62	1	TR		850,00		1.105,00
						TG-GS		1.065,00		1.400,00

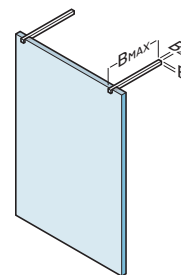

L
B <sub>1</sub> 15mm
B <sub>2</sub> 30mm
B <sub>MAX</sub> 120cm

## PORTA / DOOR

H. 200cm  
SP. 6mm



L1 [cm]	COD.	B MAX [cm]	[dm <sup>3</sup> ]	[kg]	[Pcs]	V	ULU	L96	L91	DOLCEVITA
70-85,9	B478X	62-78	107	25	1	TR		610,00		795,00
						TG-GS		765,00		995,00
86-100	B478Y	78-92	120	32	1	TR		660,00		860,00
						TG-GS		825,00		1.075,00

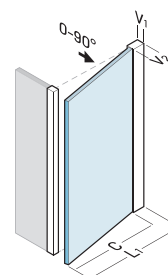

L1
V <sub>1</sub> 32mm
V <sub>2</sub> 38mm

Porta battente per chiusura in configurazione ad angolo di Open 8. Estensibilità della porta battente 2cm su profilo verticale a muro.  
Hinged door for corner configuration for Open 6. Extensibility of the hinged door by 2 cm on the vertical wall-mounted profile.

## DEFLETTORE / DEFLECTOR

H. 200cm  
SP. 8mm

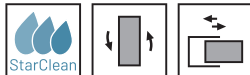

L2 [cm]	COD.	C [cm]	[dm <sup>3</sup> ]	[kg]	[Pcs]	V	ULU	L96	L91	DOLCEVITA
30	B4771	-	50	35	1	TR		400,00		520,00
						TG-GS-RF		500,00		650,00
40	B4772	-	50	35	1	TR		425,00		555,00
						TG-GS-RF		530,00		690,00
50	B4773	-	50	35	1	TR		450,00		585,00
						TG-GS-RF		565,00		735,00



L2
V <sub>1</sub> 31mm
V <sub>2</sub> 40mm



SU MISURA/CUSTOM	PARETE WALL	[€]	PORTA DOOR	DEFLETTORE DEFLECTOR	[€]
Altezza/Height <sup>1</sup>	50-245cm <sup>4</sup>	+20%	110-220cm	110-220cm	+20%
Larghezza/Width <sup>2</sup>	70-200cm	+20%	50-100cm	50-100cm	+20%
Altezza/Height	50-245cm <sup>4</sup>	+20%	110-220cm	110-220cm	+20%
Larghezza/Width <sup>2</sup>	70-200cm	+20%	50-100cm	50-100cm	+20%
Altre forme Other shapes <sup>2</sup>		+30%			+30%

OPTIONAL	[cm]	COD.	[€]
Kit sostegno 1500 1500 support kit <sup>3</sup>	L.1500	KT4091-1500	70,00
		DOLCEVITA	95,00
Kit palo pavimento-soffitto Floor-ceiling pole kit <sup>3</sup>	min.2670 max.2720	KT4900 (P.54)	290,00
		DOLCEVITA	380,00
Kit sostegno palo 1Pz Pole support kit <sup>3</sup> 1Pc	750-850	KTO (P.34)	130,00
		DOLCEVITA	170,00

<sup>1</sup> Dal prezzo della misura di riferimento / From the price of selected size

<sup>2</sup> Dal prezzo della misura superiore / From the price of the larger size

<sup>3</sup> Da richiedere al momento dell'ordine / To be requested at the time of order

<sup>4</sup> Fattibilità dopo verifica tecnica / Feasibility after technical verification

DISPONIBILITA' A MAGAZZINO / STOCK AVAILABILITY

1/2 Settimane/Weeks

2/3 Settimane/Weeks

3/4 Settimane/Weeks

# OPEN 8 SCORREVOLE

PARETE PRINCIPALE SCORREVOLE  
SLIDING MAIN WALL



Per istruzioni di montaggio  
e ricambi inquadra il codice QR  
For assembly instructions  
and spare parts, scan the QR code



H. 206cm  
SP. 8mm



Parete vetro formata da un'anta fissa e un'anta scorrevole lateralmente. L'anta scorre grazie alla presenza di due massicce ruote posizionate ad altezze diverse e contrapposte per dare la massima fluidità al movimento di apertura.

Glass wall consisting of a fixed panel and a sliding panel. The sliding panel moves smoothly thanks to the presence of two robust wheels positioned at different and opposing heights, ensuring maximum fluidity in the opening motion.

CONFIGURAZIONE IN NICCHIA  
NICHE CONFIGURATION

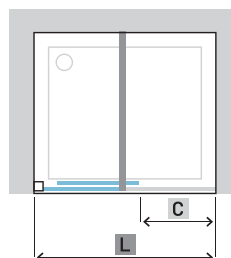

CONFIGURAZIONE IN ANGOLO  
CORNER CONFIGURATION

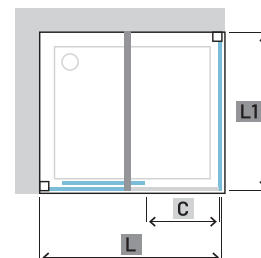

CONFIGURAZIONI A TRE LATI  
THREE-SIDED CONFIGURATIONS

Non è possibile realizzare configurazioni a tre lati.  
It is not possible to create three-sided configurations.

## ORIENTAMENTO E POSSIBILI COMBINAZIONI / ORIENTATION AND POSSIBLE CONFIGURATIONS

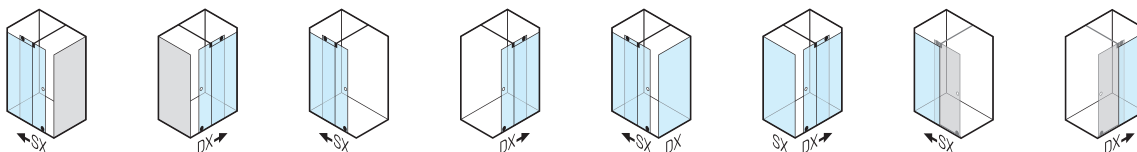

## PROFILI / PROFILES

STANDARD	
ULU	Brillantato Lucido Brilliant Polished
L91	Bianco Opaco Matte White
L96	Nero Opaco Matte Black

ATELIER	
L73	Sage Opaco Matte Sage
L86	Ambra Opaco Matte Ambra

STANDARD	
TR	Trasparente Transparent
TG	Trasparente Grigio Transparent Grey
GS	Grigio Satinato Satin Grey
RF	Fascia H.100cm Band H.100cm

ON DEMAND		
TE	Extrachiaro Extra Clear	TR +25%
AS	Satinato Satin	TR +25%
SY	Specchio Mirror <sup>4</sup>	TR +50%
TN	Sfumato Nuvola Nuvola Gradient	TR +50%

I vetri AS-GS-RF-SY non sono reversibili.  
Specificare lato apertura /DX o /SX.  
The AS-GS-RF-SY panels are non reversible.  
Specify the opening side /DX) or left /SX.

## PORTA / DOOR

L [cm]	COD.	C [cm]	[dm <sup>3</sup> ]	[kg]	[Pcs]	V	ULU	L96	L91	ATELIER
100	B4600	42	144	50	1	TR		1.070,00		1.070,00
						TG-GS-RF		1.340,00		1.340,00
120	B4601	52	174	60	1	TR		1.105,00		1.105,00
						TG-GS-RF		1.380,00		1.380,00
140	B4602	62	244	67	1	TR		1.155,00		1.155,00
						TG-GS-RF		1.445,00		1.445,00
160	B4603	72	280	76	1	TR		1.220,00		1.220,00
						TG-GS-RF		1.525,00		1.525,00
180	B4604	82	314	84	1	TR		1.355,00		1.355,00
						TG-GS-RF		1.695,00		1.695,00

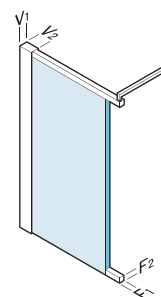

L	Value
V <sub>1</sub>	17mm
V <sub>2</sub>	40mm
F <sub>1</sub>	14mm
F <sub>2</sub>	13mm

## PARETE FISSA / FIXED PANEL

H. 205cm  
SP. 6mm

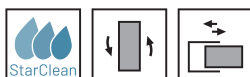

L1 [cm]	COD.	C [cm]	[dm <sup>3</sup> ]	[kg]	[Pcs]	V	ULU	L96	L91	ATELIER
68-70	B4650	-	110	36	1	TR		570,00		570,00
						TG-GS-RF		715,00		715,00
78-80	B4651	-	120	42	1	TR		630,00		630,00
						TG-GS-RF		790,00		790,00
88-90	B4652	-	130	46	1	TR		710,00		710,00
						TG-GS-RF		890,00		890,00
98-100	B4653	-	145	50	1	TR		710,00		710,00
						TG-GS-RF		890,00		890,00

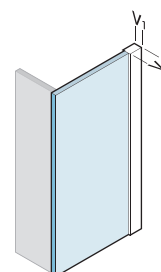

L1	Value
V <sub>1</sub>	17mm
V <sub>2</sub>	40mm

## KIT PORTA PER OPEN 8 / DOOR KIT FOR OPEN 8

H. 200cm  
SP. 8mm

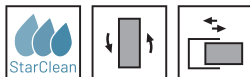

[cm]	COD.	C [cm]	[dm <sup>3</sup> ]	[kg]	[Pcs]	V	ULU	L96	L91	ATELIER
100	B461X	42	144	50	1	TR		685,00		685,00
						TG-GS-RF		855,00		855,00

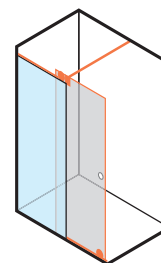

**!** Kit compatibile esclusivamente con parete vetro Open 8 (no Open 8 Mensola).  
Il kit prevede la possibilità di installare su una parete vetro Open 8 una porta e relative staffe per renderla una parete doccia Open 8 scorrevole. La porta può avere larghezza massima 100cm.  
Possibilità di ordinare il kit in un secondo momento.  
*Kit compatible exclusively with Open 8 glass wall (not Open 8 Shelf).  
The kit allows the installation of a door and related brackets on an Open 8 glass wall to convert it into a sliding Open 8 shower wall. The door can have a maximum width of 100 cm.  
The kit can be ordered at a later time.*

SU MISURA/CUSTOM	PORTA DOOR	[€]	PARETE PANEL	[€]
Altezza/Height <sup>1</sup>	150-220cm	+20%	90-220cm	+20%
Larghezza/Width <sup>2</sup>	80-220cm	+20%	35-180cm	+20%
Altezza/Height	150-220cm	+20%	90-220cm	+20%
Larghezza/Width <sup>2</sup>	80-220cm	+20%	35-180cm	+20%
Altre forme Other shapes <sup>2</sup>		+30%		+30%

OPTIONAL	[mm]	COD.	[€]
Maniglia 58cm Handle 58cm <sup>3</sup>	-	B01	ULU-L91-L96 105,00 ATELIER 105,00
Kit sostegno in linea Inline support kit <sup>3</sup>	L.2000	KT4650	ULU-L91-L96 170,00 ATELIER 170,00
Kit chiusura in nicchia Niche closing kit <sup>3</sup>	-	KT4600	ULU-L91-L96 100,00 ATELIER 100,00

<sup>1</sup> Dal prezzo della misura di riferimento / From the price of selected size

<sup>2</sup> Dal prezzo della misura superiore / From the price of the larger size

<sup>3</sup> Da richiedere al momento dell'ordine / To be requested at the time of order

<sup>4</sup> Fattibilità dopo verifica tecnica / Feasibility after technical verification

DISPONIBILITA' A MAGAZZINO / STOCK AVAILABILITY

1/2 Settimane/Weeks

2/3 Settimane/Weeks

3/4 Settimane/Weeks

# OPEN 8 COMBINAZIONI

ELEMENTI BASE  
BASIC ELEMENTS



Per istruzioni di montaggio  
e ricambi inquadra il codice QR  
For assembly instructions  
and spare parts, scan the QR code



H. 200cm  
SP. 8mm

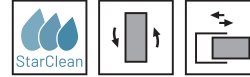

## POSSIBILI COMBINAZIONI / POSSIBLE CONFIGURATIONS

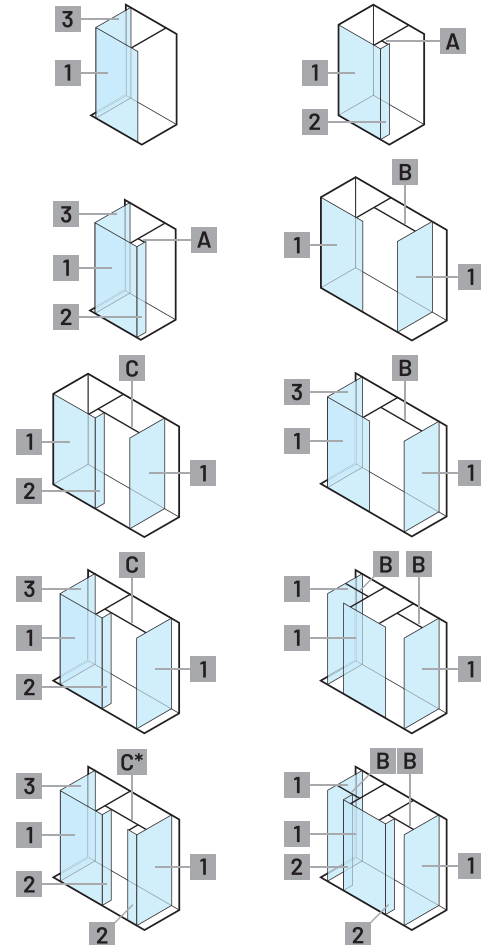

### PROFILI / PROFILES

STANDARD	
ULU	Brillantato Lucido <i>Brilliant Polished</i>
L91	Bianco Opaco <i>Matte White</i>
L96	Nero Opaco <i>Matte Black</i>

DOLCEVITA	
SNK	Nickel Spazzolato <i>Nickel Brushed</i>
AL4	Bronzo Spazzolato <i>Brushed Bronze</i>
AL5	Oro Rosa Lucido <i>Polished Rose Gold</i>
GLB	Oro Spazzolato <i>Brushed Gold</i>
GLP	Oro Lucido <i>Polished Gold</i>
GMB	Gun Metal Spazzolato <i>Brushed Gun Metal</i>

### VETRO / GLASS

STANDARD	
TR	Trasparente <i>Transparent</i>
TG	Trasparente Grigio <i>Transparent Grey</i>
GS	Grigio Satinato <i>Satin Grey</i>
RF	Fascia H.100cm <i>Band H.100cm</i>
ON DEMAND	
TE	Extrachiaro <i>Extra Clear</i> TR +25%
AS	Satinato <i>Satin</i> TR +25%
SY	Specchio <i>Mirror</i> <sup>3</sup> TR +25%

## PARETE 1 - OPEN 8 / PANEL 1 - OPEN 8

L [cm]	COD.	B MAX [cm]	[dm <sup>3</sup> ]	[kg]	[Pcs]	V	ULU L96 L91	DOLCEVITA
76,5-78	B4081	120	120	34	1	TR	640,00	830,00
78,5-80	B4051					TG-GS-RF	800,00	1.040,00
86,5-88	B4082	120	135	39	1	TR	725,00	945,00
88,5-90	B4052					TG-GS-RF	905,00	1.175,00
96,5-98	B4083	120	150	44	1	TR	725,00	945,00
98,5-100	B4053					TG-GS-RF	905,00	1.175,00
116,5-118	B4084	120	181	54	1	TR	790,00	1.025,00
118,5-120	B4054					TG-GS-RF	990,00	1.285,00
136,5-138	B4085	120	244	64	1	TR	855,00	1.110,00
138,5-140	B4055					TG-GS-RF	1.070,00	1.390,00
156,5-158	B4086	120	270	75	1	TR	920,00	1.195,00
158,5-160	B4056					TG-GS-RF	1.150,00	1.495,00
176,5-178	B4087	120	300	83	1	TR	985,00	1.280,00
178,5-180	B4057					TG-GS-RF	1.230,00	1.600,00

## PARETE 2 / PANEL 2

H. 200cm  
SP. 6mm



L [cm]	COD.	C [cm]	[dm <sup>3</sup> ]	[kg]	[Pcs]	V	ULU L96 L91	DOLCEVITA
20	B4040	120	133	42	1	TR	240,00	310,00
						TG-GS-RF	300,00	390,00
30	B4041	120	174	52	1	TR	265,00	345,00
						TG-GS-RF	330,00	430,00

## PARETE 3 / PANEL 3

H. 200cm  
SP. 8mm

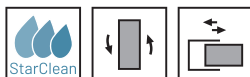

L [cm]	COD.	C [cm]	[dm <sup>3</sup> ]	[kg]	[Pcs]	V	ULU L96 L91	DOLCEVITA
77,5-79	B4045	120	246	62	1	TR	570,00	740,00
						TG-GS-RF	715,00	930,00
87,5-89	B4047	120	246	62	1	TR	650,00	845,00
						TG-GS-RF	815,00	1.060,00
97,5-99	B4049	120	246	62	1	TR	650,00	845,00
						TG-GS-RF	815,00	1.060,00

## KIT DI SOSTEGNO / SUPPORT KIT

RIF.	[mm]	COD.	ULU L96 L91	DOLCEVITA
A	150	KT4000	50,00	65,00
B	700	KT4001	80,00	105,00
C	700	KT4002	105,00	140,00

! C\* KT4002 da realizzare speciale in base alla configurazione

C\* KT4002 to be made special based on the configuration

SU MISURA/CUSTOM	PARETE WALL	[€]
↕ Altezza/Height <sup>1</sup>	110-220cm	+20%
↔ Larghezza/Width <sup>2</sup>	20-110cm	+20%
↕ Altezza/Height ↔ Larghezza/Width <sup>2</sup>	110-220cm 20-110cm	+20%
Altre forme Other shapes <sup>2</sup>		+30%

<sup>1</sup> Dal prezzo della misura di riferimento / From the price of selected size

<sup>2</sup> Dal prezzo della misura superiore / From the price of the larger size

<sup>3</sup> Fattibilità dopo verifica tecnica / Feasibility after technical verification

DISPONIBILITA' A MAGAZZINO / STOCK AVAILABILITY

1/2 Settimane/Weeks

2/3 Settimane/Weeks

3/4 Settimane/Weeks



## PARETI DOCCIA

### SHOWER ENCLOSURES

Con il catalogo Samo 80 abbiamo deciso di offrire ai nostri clienti uno strumento di lavoro totalmente rinnovato e semplificato nel suo utilizzo. Per la sezione dedicata alle Pareti Doccia abbiamo riposizionato i nostri prodotti seguendo un ordine più strutturato e rigoroso, in modo da trovare sempre velocemente il prodotto desiderato. L'inserimento delle finiture DolceVita su Pyxis, Acrux e Polaris ci ha permesso di realizzare un unico supporto di lavoro sul quale ritrovare facilmente tutto il mondo Samo. Per dare ulteriore libertà e creatività abbiamo deciso di introdurre nuovi vetri, Trasparente Extrachiaro, Cannettato (su Open 6) e Sfumato Nuvola (su Open 8) e abbiamo esteso su tutta la nostra gamma di prodotti con vetri di spessore 8mm e 6mm la possibilità di richiedere su richiesta tutte i vetri tecnicamente fattibili, ad oggi possibilità mai prevista nell'offerta di Samo.

*With the Samo 80 catalog, we have decided to offer our customers a completely renewed and simplified working tool. For the section dedicated to Shower Walls, we have repositioned our products following a more structured and rigorous order, making it easier to quickly find the desired product.*











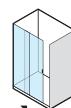
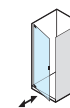
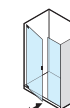
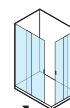
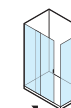
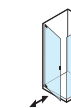
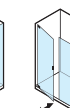
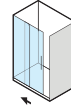
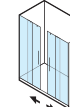
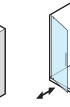
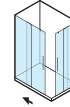
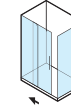
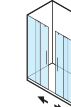
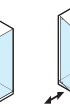
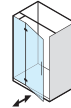
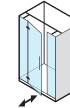
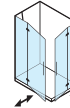
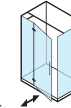
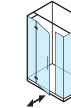
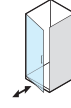
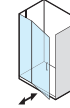
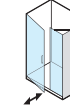
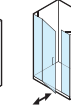
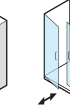
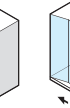
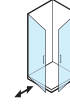
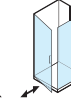
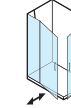

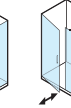
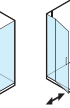
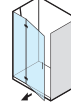
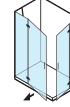
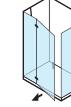
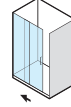
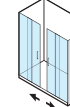
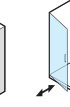

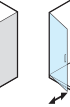
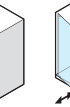
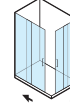
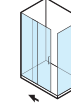
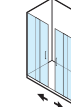
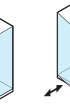
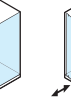
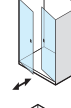
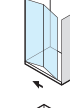
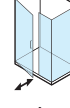
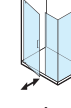
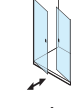
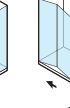
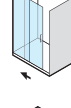
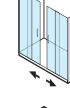
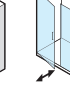

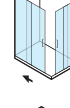
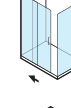
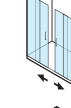
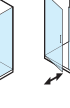

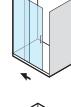
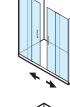
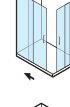
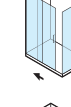
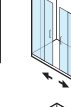
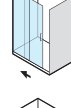
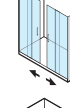
*The inclusion of DolceVita finishes on Pyxis, Acrux, and Polaris has allowed us to create a single working support where you can easily find everything related to the Samo world.*

*To provide further freedom and creativity, we have decided to introduce new glass options: Extra Clear Transparent, Ribbed (on Open 6), and Cloudy Gradient (on Open 8). We have also extended the possibility to request any technically feasible glass for our entire range of products with 8mm and 6mm thicknesses, a feature not previously available in Samo's offerings.*

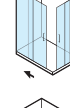
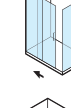
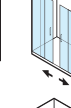
**PARETI DOCCIA**  
**SHOWER ENCLOSURES**

 CONFIGURAZIONE IN NICCHIA  
NICHE CONFIGURATION

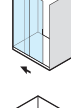
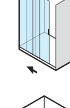
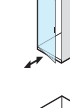
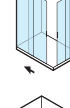
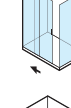
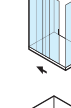
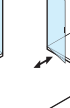
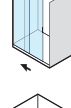
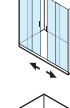
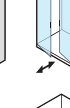
 CONFIGURAZIONE IN ANGOLO  
CORNER CONFIGURATION

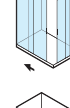
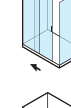
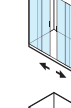
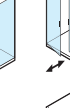
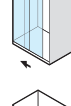
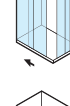
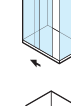
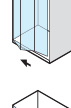
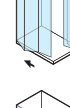
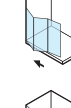
PYXIS	  	   
ACRUX	  	   
ZENITH	 	  
POLARIS / ALTER	     	     
GRAND POLARIS		 
EUROPA	     	    
EUROPA SP	 	   
CEE ART	    	     
CEE ART SP	 	  
AMERICA QUATTRO	    	     
AMERICA QUATTRO SP	  	   
AMERICA	    	   
FLEX		 
CIAO		 

**CONFIGURAZIONE A TRE LATI**  
**THREE-SIDED CONFIGURATION**

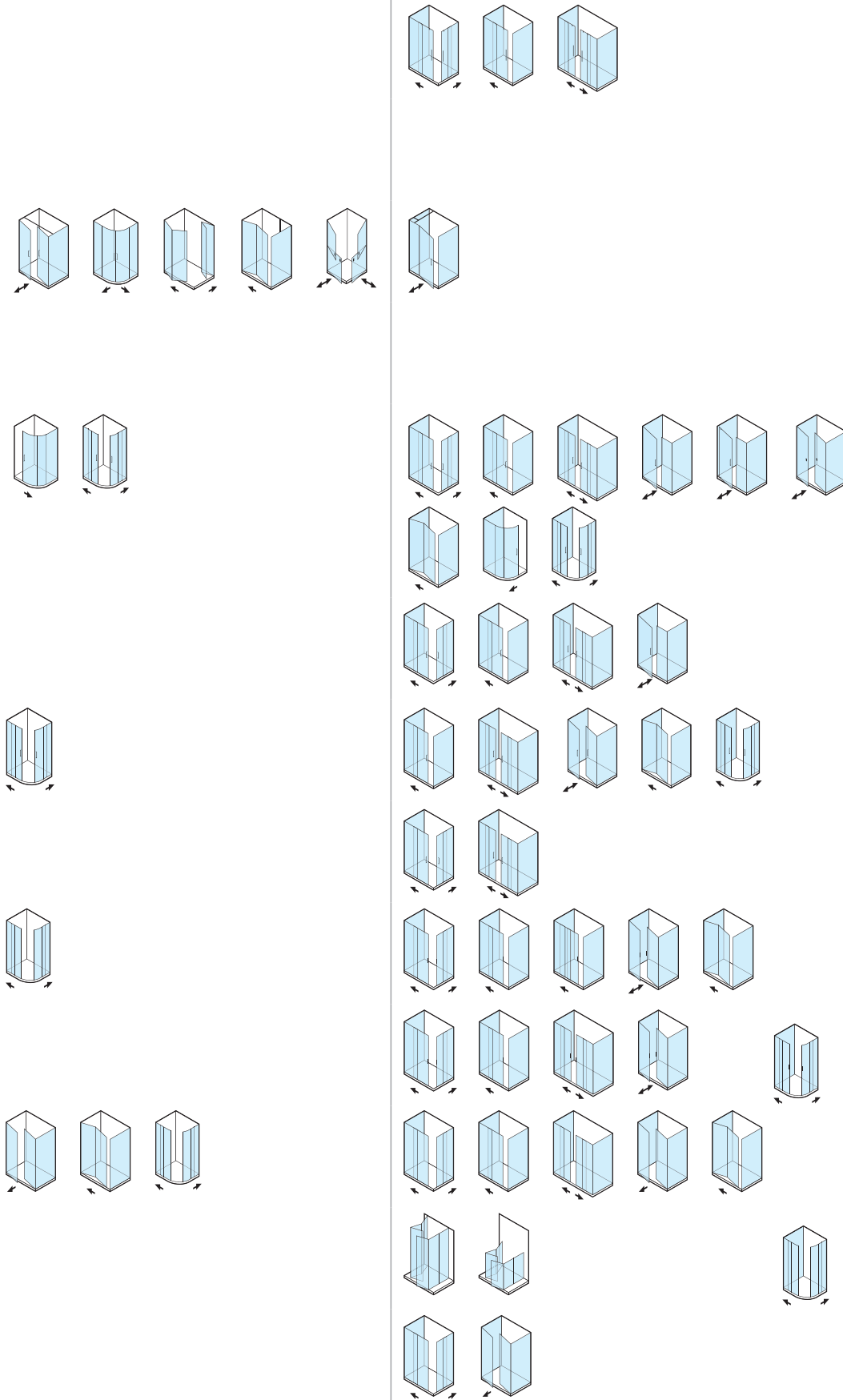

# PYXIS



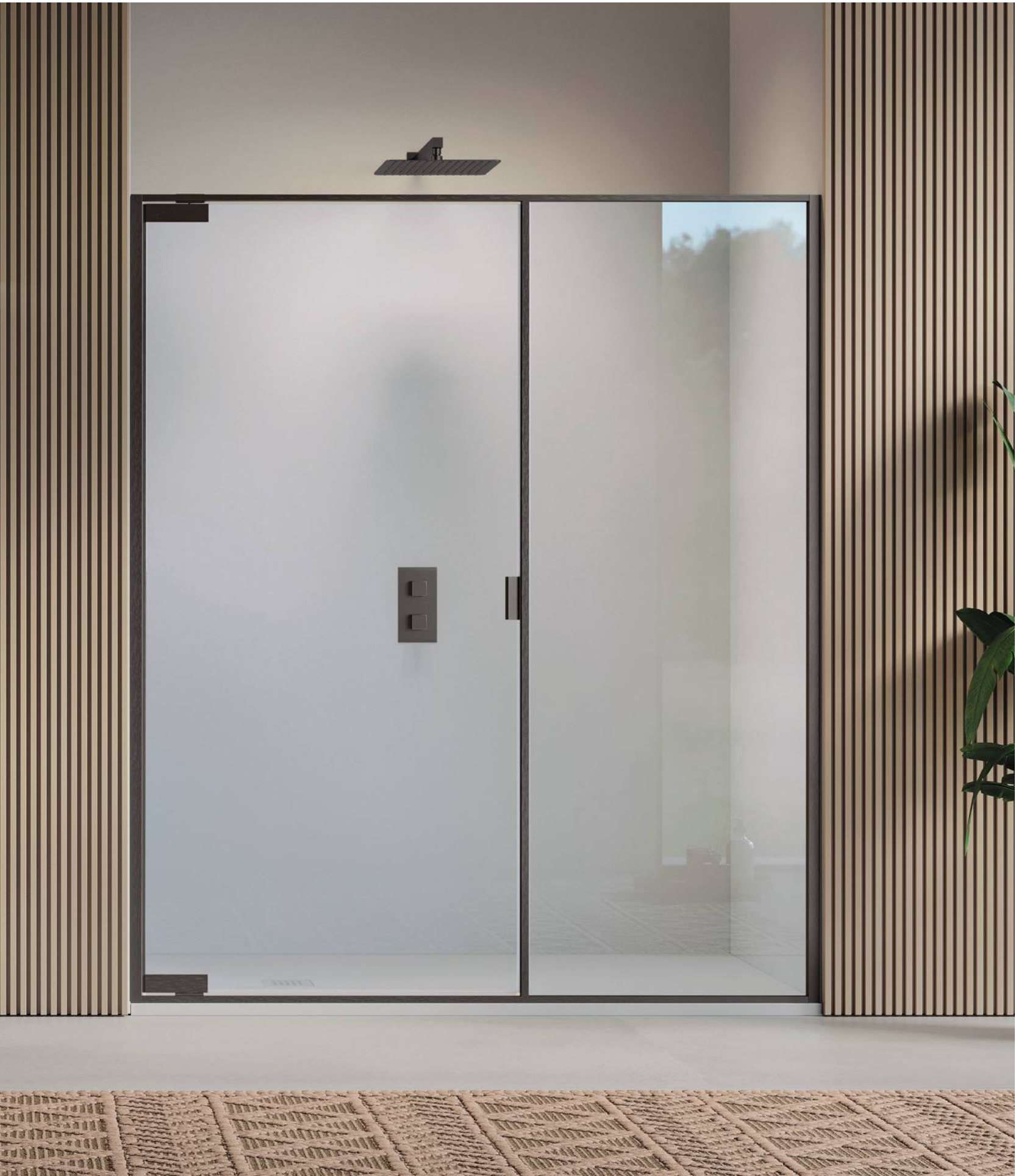















- > Parete doccia con telaio parziale
- > Vetro temperato 6mm per porte scorrevoli e pareti fisse, 8mm per porte battenti pivot
- > Trattamento anticalcare StarClean di serie incluso nel prezzo
- > Estensibilità e regolazione fuori squadra del muro fino a 1cm
- > Profili orizzontali H.1,5cm
- > Maniglia e componentistica in finitura con il telaio
- > Sgancio anta scorrevole per una agile pulizia del prodotto
- > Sistema scorrimenti e cerniere pivot incollati su vetro con tecnologia UV
- > Profilo magnetico di chiusura in alluminio su porte scorrevoli
- > Profilo magnetico di chiusura in alluminio bilaterale a scomparsa a triplo magnete su porte battenti

- > Shower enclosure with partial frame
- > 6mm tempered glass for sliding doors and fixed panels, 8mm for pivot-hinged doors
- > StarClean anti-limescale treatment included in the price
- > Wall adjustment and out-of-square compensation up to 1cm
- > Horizontal profiles H.1.5cm
- > Handle and components finished to match the frame
- > Detachable sliding door for easy product cleaning
- > Sliding system and pivot hinges glued to the glass with UV technology
- > Magnetic aluminum closing profile on sliding doors
- > Bilateral concealed aluminum magnetic closing profile with triple magnet on pivot-hinged doors

# PYXIS

## PRODOTTI DELLA SERIE / PRODUCTS OF THE SERIES

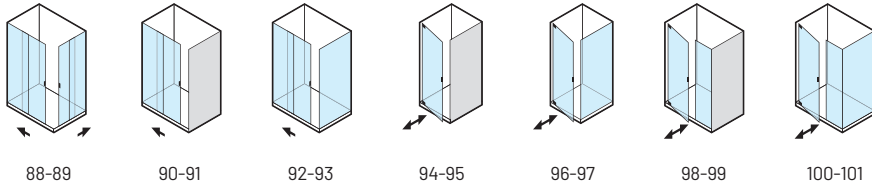

## PROFILI / PROFILES

### STANDARD



**ULU**  
Brilliantato Lucido  
*Brilliant Polished*

**L91**  
Bianco Opaco  
*Matte White*

**L96**  
Nero Opaco  
*Matte Black*

### DOLCEVITA

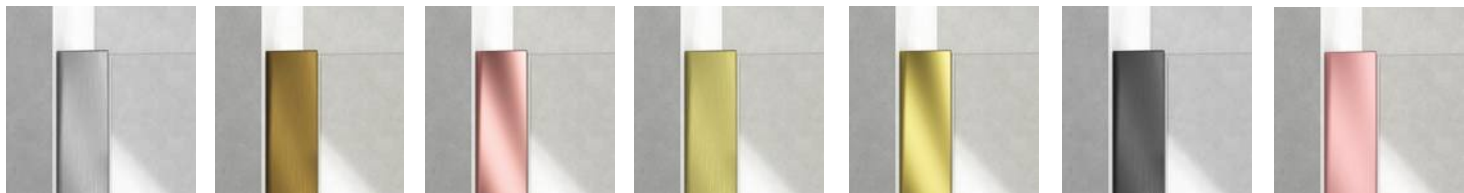

**SNK**  
Nickel Spazzolato  
*Brushed Nickel*

**AL4**  
Bronzo Spazzolato  
*Brushed Bronze*

**AL5**  
Oro Rosa Lucido  
*Polished Rose Gold*

**GLB**  
Oro Spazzolato  
*Brushed Gold*

**GLP**  
Oro Lucido  
*Polished Gold*

**GMB**  
Gun Metal Spazzolato  
*Brushed Gun Metal*

**L55**  
Rosa Metalizzato  
*Metallic Pink*

## VETRO / GLASS

### STANDARD



**TR**  
Trasparente  
*Transparent*

**TG**  
Trasparente Grigio  
*Transparent Grey*

### ON DEMAND



**TE**  
Extra Chiaro  
*Extra Clear*

**RF**  
Fascia H.100cm  
*Band H.100cm*

# PYXIS

LATO ANGOLO  
SIDE CORNER



Per istruzioni di montaggio  
e ricambi inquadra il codice QR  
For assembly instructions  
and spare parts, scan the QR code



**H. 200cm**  
**SP. 6mm**



Parete doccia ad angolo a quattro ante, apertura ad ante scorrevoli nell'angolo del prodotto. Modello adatto per la maggior parte delle installazioni e disponibile in un'ampia gamma di dimensioni, soprattutto per chi vuole massimizzare le dimensioni d'ingresso.

*Corner shower wall with four panels, featuring sliding doors at the corner of the product. Suitable for most installations and available in a wide range of sizes, especially for those looking to maximize the entry dimensions.*

### CONFIGURAZIONE AD ANGOLO CORNER CONFIGURATION

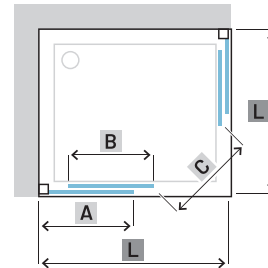

### CONFIGURAZIONI IN NICCHIA E A TRE LATI NICHE AND THREE-SIDED CONFIGURATIONS

Non è possibile realizzare configurazioni in nicchia.  
Non è possibile realizzare configurazioni a tre lati.  
*It is not possible to create niche configurations.  
It is not possible to create three-sided configurations.*

### ORIENTAMENTO E POSSIBILI COMBINAZIONI / ORIENTATION AND POSSIBLE CONFIGURATIONS

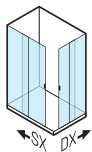

#### PROFILI / PROFILES

STANDARD	
ULU	Brillantato Lucido Brilliant Polished
L91	Bianco Opaco Matte White
L96	Nero Opaco Matte Black

DOLCEVITA	
SNK	Nickel Spazzolato Nickel Brushed
AL4	Bronzo Spazzolato Brushed Bronze
AL5	Oro Rosa Lucido Polished Rose Gold
GLB	Oro Spazzolato Brushed Gold
GLP	Oro Lucido Polished Gold
GMB	Gun Metal Spazzolato Brushed Gun Metal
L55	Rosa Metallizzato Metallic Pink

#### VETRO / GLASS

STANDARD		
TR	Trasparente Transparent	
TG	Trasparente Grigio Transparent Grey	
ON DEMAND		
TE	Extrachiario Extra Clear	TR +25%
RF	Fascia H.100cm Band H.100cm	TR +25%

**PORTA / DOOR**

L [cm]	COD.	A [cm]	B [cm]	C [cm]	[dm <sup>3</sup> ]	[kg]	[Pcs]	V				DOLCEVITA
									ULU	L96	L91	
67,5-68,5	B1820	34,2-35,2	31	34	118	28	1	TR	725,00			945,00
								TG	905,00		1.175,00	
68,5-69,5	B1821	34,2-35,2	31	34	119	29	1	TR	725,00			945,00
								TG	905,00		1.175,00	
77,5-78,5	B1822	39,2-40,2	36	41	137	32	1	TR	760,00			990,00
								TG	950,00		1.235,00	
78,5-79,5	B1823	39,2-40,2	36	41	138	33	1	TR	760,00			990,00
								TG	950,00		1.235,00	
87,5-88,5	B1824	44,2-45,2	41	48	151	37	1	TR	785,00			1.020,00
								TG	980,00		1.275,00	
88,5-89,5	B1825	44,2-45,2	41	48	152	38	1	TR	785,00			1.020,00
								TG	980,00		1.275,00	
97,5-98,5	B1826	54,2-55,2	41	48	168	41	1	TR	810,00			1.055,00
								TG	1.015,00		1.320,00	
98,5-99,5	B1827	54,2-55,2	41	48	169	42	1	TR	810,00			1.055,00
								TG	1.015,00		1.320,00	
117,5-118,5	B1828	74,2-75,2	41	48	201	47	1	TR	880,00			1.145,00
								TG	1.100,00		1.430,00	
118,5-119,5	B1829	74,2-75,2	41	48	202	48	1	TR	880,00			1.145,00
								TG	1.100,00		1.430,00	

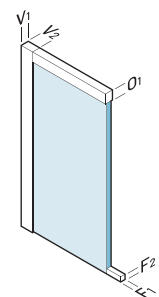

L	
V <sub>1</sub>	35mm
V <sub>2</sub>	28mm
O <sub>1</sub>	20mm
F <sub>1</sub>	10mm
F <sub>2</sub>	10mm

! I valori della tabella prezzi si riferiscono ad un singolo lato: sommare l'importo dei due codici della misura desiderata per ottenere il prezzo totale di una doccia ad angolo quadrata o rettangolare. Apertura (C) determinata con due lati della stessa misura. Specificare il verso di apertura della parete doccia (/SX o /DX).  
 The prices in the table refer to a single side: add the amounts of the two codes for the desired size to get the total price of a square or rectangular corner shower. Opening (C) is determined by two sides of the same size. Specify the opening direction of the shower enclosure (/SX or /DX).

SU MISURA/CUSTOM	PORTA DOOR	[€]
↕ Altezza/Height <sup>1</sup>	150-200cm	+20%
↔ Larghezza/Width <sup>2</sup>	67,5-120cm	+20%
↕ Altezza/Height ↔ Larghezza/Width <sup>2</sup>	150-200cm 67,5-120cm	+20%
Altre forme Other shapes <sup>2</sup>		+30%

OPTIONAL	COD.	[€]
Profilo compensazione Compensation profile	COM11A STANDARD (+3cm) DOLCEVITA	90,00 120,00

<sup>1</sup> Dal prezzo della misura di riferimento/From the price of selected size  
<sup>2</sup> Dal prezzo della misura superiore/From the price of the larger size

DISPONIBILITA' A MAGAZZINO / STOCK AVAILABILITY

1/2 Settimane/Weeks    2/3 Settimane/Weeks    3/4 Settimane/Weeks

# PYXIS

PORTA SCORREVOLE  
SLIDING DOOR



Per istruzioni di montaggio  
e ricambi inquadra il codice QR  
For assembly instructions  
and spare parts, scan the QR code



**H. 200cm**  
**SP. 6mm**



Parete doccia a due ante con apertura laterale scorrevole. Modello adatto per la maggior parte delle installazioni e disponibile in un'ampia gamma di dimensioni.

Shower wall with two panels and side sliding opening. Suitable for most installations and available in a wide range of sizes.

### CONFIGURAZIONE IN NICCHIA NICHE CONFIGURATION

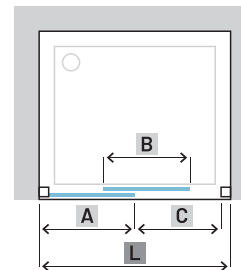

### CONFIGURAZIONI IN ANGOLO E A TRE LATI CORNER AND THREE-SIDED CONFIGURATIONS

Non è possibile realizzare configurazioni in angolo.  
Non è possibile realizzare configurazioni a tre lati.  
It is not possible to create corner configurations.  
It is not possible to create three-sided configurations.

### ORIENTAMENTO E POSSIBILI COMBINAZIONI / ORIENTATION AND POSSIBLE CONFIGURATIONS

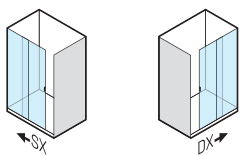

### PROFILI / PROFILES

STANDARD	
ULU	Brillantato Lucido Brilliant Polished
L91	Bianco Opaco Matte White
L96	Nero Opaco Matte Black

DOLCEVITA	
SNK	Nickel Spazzolato Nickel Brushed
AL4	Bronzo Spazzolato Brushed Bronze
AL5	Oro Rosa Lucido Polished Rose Gold
GLB	Oro Spazzolato Brushed Gold
GLP	Oro Lucido Polished Gold
GMB	Gun Metal Spazzolato Brushed Gun Metal
L55	Rosa Metallizzato Metallic Pink

### VETRO / GLASS

STANDARD		
TR	Trasparente Transparent	
TG	Trasparente Grigio Transparent Grey	
ON DEMAND		
TE	Extrachiario Extra Clear	TR +25%
RF	Fascia H.100cm Band H.100cm	TR +25%

**PORTA / DOOR**

L [cm]	COD.	A [cm]	B [cm]	C [cm]	[dm <sup>3</sup> ]	[kg]	[Pcs]	V	ULU	L96	L91	DOLCEVITA
96,5-98,5	B1770	48	48	40	184	36	2	TR	965,00			1.255,00
								TG	1.205,00		1.565,00	
98,5-100,5	B1771	50	48	40	187	37	2	TR	965,00			1.255,00
								TG	1.205,00		1.565,00	
106,5-108,5	B1772	53	53	45	203	40	2	TR	1.010,00			1.315,00
								TG	1.265,00		1.645,00	
108,5-110,5	B1773	55	53	45	206	41	2	TR	1.010,00			1.315,00
								TG	1.265,00		1.645,00	
116,5-118,5	B1774	58	58	50	222	44	2	TR	1.040,00			1.350,00
								TG	1.300,00		1.690,00	
118,5-120,5	B1775	60	58	50	226	44	2	TR	1.040,00			1.350,00
								TG	1.300,00		1.690,00	
136,5-138,5	B1776	68	68	60	260	51	2	TR	1.125,00			1.465,00
								TG	1.405,00		1.825,00	
138,5-140,5	B1777	70	68	60	264	52	2	TR	1.125,00			1.465,00
								TG	1.405,00		1.825,00	
156,5-158,5	B1778	78	78	70	298	59	2	TR	1.225,00			1.595,00
								TG	1.530,00		1.990,00	
158,5-160,5	B1779	80	78	70	302	59	2	TR	1.225,00			1.595,00
								TG	1.530,00		1.990,00	

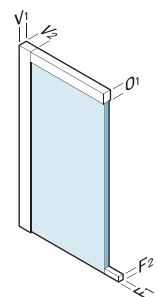

L	
V <sub>1</sub>	54mm
V <sub>2</sub>	28mm
O <sub>1</sub>	15mm
F <sub>1</sub>	10mm
F <sub>2</sub>	10mm

SU MISURA/CUSTOM	PORTA DOOR	[€]
↕ Altezza/Height <sup>1</sup>	150-200cm	+20%
↔ Larghezza/Width <sup>2</sup>	80-158,5cm	+20%
↕ Altezza/Height ↔ Larghezza/Width <sup>2</sup>	150-200cm 80-158,5cm	+20%
Altre forme Other shapes <sup>2</sup>		+30%

OPTIONAL	COD.	[€]
Profilo compensazione Compensation profile	COM11A STANDARD (+3cm) DOLCEVITA	90,00 120,00

<sup>1</sup> Dal prezzo della misura di riferimento/From the price of selected size

<sup>2</sup> Dal prezzo della misura superiore/From the price of the larger size

DISPONIBILITA' A MAGAZZINO / STOCK AVAILABILITY

1/2 Settimane/Weeks

2/3 Settimane/Weeks

3/4 Settimane/Weeks

# PYXIS

PORTA SCORREVOLE + PARETE FISSA DEDICATA  
SLIDING DOOR + DEDICATED FIXED WALL



Per istruzioni di montaggio  
e ricambi inquadra il codice QR  
For assembly instructions  
and spare parts, scan the QR code



**H. 200cm**  
**SP. 6mm**



Parete doccia a due ante con apertura laterale scorrevole con parete fissa dedicata per configurazioni ad angolo. Modello adatto per la maggior parte delle installazioni e disponibile in un'ampia gamma di dimensioni.

Shower enclosure with two sliding doors and a dedicated fixed panel for corner configurations. A model suitable for most installations and available in a wide range of sizes.

### CONFIGURAZIONE AD ANGOLO CORNER CONFIGURATION

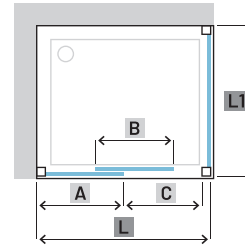

### CONFIGURAZIONI IN NICCHIA E A TRE LATI NICHE AND THREE-SIDED CONFIGURATIONS

Non è possibile realizzare configurazioni in nicchia.  
Non è possibile realizzare configurazioni a tre lati.  
It is not possible to create niche configurations.  
It is not possible to create three-sided configurations.

### ORIENTAMENTO E POSSIBILI COMBINAZIONI / ORIENTATION AND POSSIBLE CONFIGURATIONS

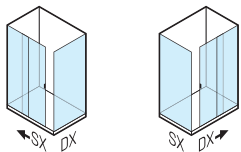

### PROFILI / PROFILES

STANDARD	
ULU	Brillantato Lucido Brilliant Polished
L91	Bianco Opaco Matte White
L96	Nero Opaco Matte Black

DOLCEVITA	
SNK	Nickel Spazzolato Nickel Brushed
AL4	Bronzo Spazzolato Brushed Bronze
AL5	Oro Rosa Lucido Polished Rose Gold
GLB	Oro Spazzolato Brushed Gold
GLP	Oro Lucido Polished Gold
GMB	Gun Metal Spazzolato Brushed Gun Metal
L55	Rosa Metallizzato Metallic Pink

### VETRO / GLASS

STANDARD		
TR	Trasparente Transparent	
TG	Trasparente Grigio Transparent Grey	
ON DEMAND		
TE	Extrachiario Extra Clear	TR +25%
RF	Fascia H.100cm Band H.100cm	TR +25%

## PORTA / DOOR

L [cm]	COD.	A [cm]	B [cm]	C [cm]	[dm <sup>3</sup> ]	[kg]	[Pcs]	V	ULU	L96	L91	DOLCEVITA
97,5-98,5	B1780	50	48	40	184	36	2	TR	915,00			1.190,00
								TG	1.145,00			1.490,00
98,5-99,5	B1781	50	48	40	186	36	2	TR	915,00			1.190,00
								TG	1.145,00			1.490,00
107,5-108,5	B1782	55	53	45	203	40	2	TR	955,00			1.240,00
								TG	1.195,00			1.555,00
108,5-109,5	B1783	55	53	45	205	40	2	TR	955,00			1.240,00
								TG	1.195,00			1.555,00
117,5-118,5	B1784	60	58	50	222	44	2	TR	990,00			1.285,00
								TG	1.240,00			1.610,00
118,5-119,5	B1785	60	58	50	224	44	2	TR	990,00			1.285,00
								TG	1.240,00			1.610,00
137,5-138,5	B1786	70	68	60	260	51	2	TR	1.070,00			1.390,00
								TG	1.340,00			1.740,00
138,5-139,5	B1787	70	68	60	262	51	2	TR	1.070,00			1.390,00
								TG	1.340,00			1.740,00
157,5-158,5	B1788	80	78	70	298	58	2	TR	1.165,00			1.515,00
								TG	1.455,00			1.890,00
158,5-159,5	B1789	80	78	70	300	59	2	TR	1.165,00			1.515,00
								TG	1.455,00			1.890,00

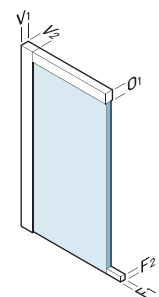

L	
V <sub>1</sub>	35mm
V <sub>2</sub>	28mm
O <sub>1</sub>	15mm
F <sub>1</sub>	10mm
F <sub>2</sub>	10mm

## PARETE FISSA / FIXED PANEL

H. 200cm  
SP. 6mm



L1 [cm]	COD.	A [cm]	B [cm]	C [cm]	[dm <sup>3</sup> ]	[kg]	[Pcs]	V	ULU	L96	L91	DOLCEVITA
67,5-68,5	B1790	-	-	-	121	24	1	TR	395,00			515,00
								TG	495,00			645,00
68,5-69,5	B1791	-	-	-	123	24	1	TR	395,00			515,00
								TG	495,00			645,00
72,5-73,5	B1792	-	-	-	126	26	1	TR	405,00			525,00
								TG	505,00			655,00
73,5-74,5	B1793	-	-	-	128	26	1	TR	405,00			525,00
								TG	505,00			655,00
77,5-78,5	B1794	-	-	-	130	28	1	TR	415,00			540,00
								TG	520,00			675,00
78,5-79,5	B1795	-	-	-	132	28	1	TR	415,00			540,00
								TG	520,00			675,00
87,5-88,5	B1796	-	-	-	142	31	1	TR	435,00			565,00
								TG	545,00			710,00
88,5-89,5	B1797	-	-	-	144	31	1	TR	435,00			565,00
								TG	545,00			710,00
97,5-98,5	B1798	-	-	-	149	33	1	TR	460,00			600,00
								TG	575,00			750,00
98,5-99,5	B1799	-	-	-	151	33	1	TR	460,00			600,00
								TG	575,00			750,00

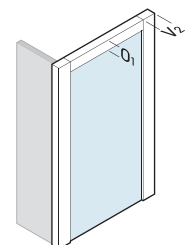

L1	
V <sub>2</sub>	28mm
O <sub>1</sub>	15mm

SU MISURA/CUSTOM	PORTA DOOR	[€]	PARETE FISSA FIXED PANEL	[€]
↕ Altezza/Height <sup>1</sup>	150-200cm	+20%	150-200cm	+20%
↔ Larghezza/Width <sup>2</sup>	80-158,5cm	+20%	30-140cm	+20%
↕ Altezza/Height ↔ Larghezza/Width <sup>2</sup>	150-200cm 80-158,5cm	+20%	150-200cm 30-140cm	+20%
Altre forme Other shapes <sup>2</sup>		+30%		+30%

OPTIONAL	COD.	[€]
Profilo compensazione Compensation profile	COM11A STANDARD (+3cm) DOLCEVITA	90,00 120,00

<sup>1</sup> Dal prezzo della misura di riferimento/From the price of selected size

<sup>2</sup> Dal prezzo della misura superiore/From the price of the larger size

DISPONIBILITA' A MAGAZZINO / STOCK AVAILABILITY

1/2 Settimane/Weeks

2/3 Settimane/Weeks

3/4 Settimane/Weeks

# PYXIS

## PORTA BATTENTE PIVOT PIVOT HINGED DOOR



Per istruzioni di montaggio  
e ricambi inquadra il codice QR  
For assembly instructions  
and spare parts, scan the QR code



**H. 200cm**  
**SP. 8mm**



Parete doccia con apertura a porta battente pivotante. L'apertura dell'anta è sia verso l'interno che verso l'esterno. Modello adatto per situazioni che necessitano di aperture generose, ma di ingombri minimizzati all'interno del bagno.

Shower enclosure with a pivoting hinged door. The door opens both inward and outward. A model suitable for situations requiring generous openings while minimizing space usage inside the bathroom.

### CONFIGURAZIONE IN NICCHIA NICHE CONFIGURATION

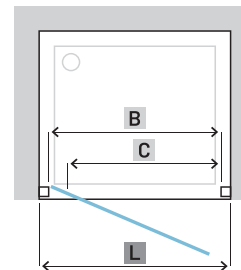

### CONFIGURAZIONI IN ANGOLO E A TRE LATI CORNER AND THREE-SIDED CONFIGURATIONS

Non è possibile realizzare configurazioni in angolo.  
Non è possibile realizzare configurazioni a tre lati.  
It is not possible to create corner configurations.  
It is not possible to create three-sided configurations.

### ORIENTAMENTO E POSSIBILI COMBINAZIONI / ORIENTATION AND POSSIBLE CONFIGURATIONS

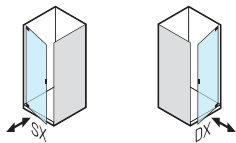

### PROFILI / PROFILES

STANDARD	
ULU	Brillantato Lucido Brilliant Polished
L91	Bianco Opaco Matte White
L96	Nero Opaco Matte Black

DOLCEVITA	
SNK	Nickel Spazzolato Nickel Brushed
AL4	Bronzo Spazzolato Brushed Bronze
AL5	Oro Rosa Lucido Polished Rose Gold
GLB	Oro Spazzolato Brushed Gold
GLP	Oro Lucido Polished Gold
GMB	Gun Metal Spazzolato Brushed Gun Metal
L55	Rosa Metallizzato Metallic Pink

### VETRO / GLASS

STANDARD		
TR	Trasparente Transparent	
TG	Trasparente Grigio Transparent Grey	
ON DEMAND		
TE	Extrachiario Extra Clear	TR +25%
RF	Fascia H.100cm Band H.100cm	TR +25%

**PORTA / DOOR**

L [cm]	COD.	A [cm]	B [cm]	C [cm]	[dm <sup>3</sup> ]	[kg]	[Pcs]	V	ULU	L96	L91	DOLCEVITA
67-69	B1700	-	47	48	117	24	1	TR	1.135,00			1.475,00
								TG	1.420,00			1.845,00
69-71	B1701	-	49	50	120	25	1	TR	1.135,00			1.475,00
								TG	1.420,00			1.845,00
72-74	B1702	-	52	53	131	27	1	TR	1.155,00			1.500,00
								TG	1.445,00			1.880,00
74-76	B1703	-	54	55	135	28	1	TR	1.155,00			1.500,00
								TG	1.445,00			1.880,00
77-79	B1704	-	57	58	148	30	1	TR	1.165,00			1.515,00
								TG	1.455,00			1.890,00
79-81	B1705	-	59	60	152	31	1	TR	1.165,00			1.515,00
								TG	1.455,00			1.890,00
87-89	B1706	-	67	68	163	33	1	TR	1.185,00			1.540,00
								TG	1.480,00			1.925,00
89-91	B1707	-	69	70	167	34	1	TR	1.185,00			1.540,00
								TG	1.480,00			1.925,00
97-99	B1708	-	77	78	175	35	1	TR	1.225,00			1.595,00
								TG	1.530,00			1.990,00
99-101	B1709	-	79	80	179	36	1	TR	1.225,00			1.595,00
								TG	1.530,00			1.990,00

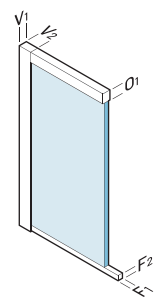

L	
V <sub>1</sub>	54mm
V <sub>2</sub>	28mm
O <sub>1</sub>	15mm
O <sub>3</sub>	15mm
O <sub>4</sub>	15mm

SU MISURA/CUSTOM	PORTA DOOR	[€]
↕ Altezza/Height <sup>1</sup>	150-200cm	+20%
↔ Larghezza/Width <sup>2</sup>	60-99cm	+20%
↕↔ Altezza/Height Larghezza/Width <sup>2</sup>	150-200cm 60-99cm	+20%
Altre forme Other shapes <sup>2</sup>		+30%

OPTIONAL	COD.	[€]
Profilo compensazione Compensation profile	COM11A STANDARD (+3cm) DOLCEVITA	90,00 120,00

<sup>1</sup> Dal prezzo della misura di riferimento/From the price of selected size

<sup>2</sup> Dal prezzo della misura superiore/From the price of the larger size

DISPONIBILITA' A MAGAZZINO / STOCK AVAILABILITY

1/2 Settimane/Weeks

2/3 Settimane/Weeks

3/4 Settimane/Weeks

# PYXIS

PORTA BATTENTE PIVOT + PARETE FISSA DEDICATA  
PIVOT HINGED DOOR + DEDICATED FIXED PANEL



Per istruzioni di montaggio  
e ricambi inquadra il codice QR  
For assembly instructions  
and spare parts, scan the QR code



**H. 200cm**  
**SP. 8mm**



Parete doccia con apertura a porta battente pivotante con parete fissa dedicata per configurazioni ad angolo. L'apertura dell'anta è sia verso l'interno che verso l'esterno. Modello adatto per situazioni che necessitano di aperture generose, ma di ingombri minimizzati all'interno del bagno.

Shower enclosure with a pivoting hinged door and a dedicated fixed panel for corner configurations. The door opens both inward and outward. A model suitable for situations requiring generous openings while minimizing space usage inside the bathroom.

### CONFIGURAZIONE AD ANGOLO CORNER CONFIGURATION

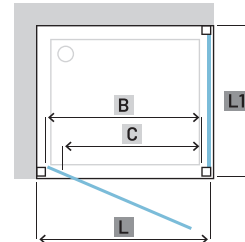

### CONFIGURAZIONI IN NICCHIA E A TRE LATI NICHE AND THREE-SIDED CONFIGURATIONS

Non è possibile realizzare configurazioni in nicchia.  
Non è possibile realizzare configurazioni a tre lati.  
It is not possible to create niche configurations.  
It is not possible to create three-sided configurations.

### ORIENTAMENTO E POSSIBILI COMBINAZIONI / ORIENTATION AND POSSIBLE CONFIGURATIONS

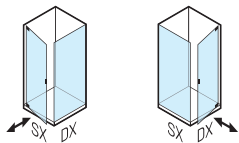

### PROFILI / PROFILES

STANDARD	
ULU	Brillantato Lucido Brilliant Polished
L91	Bianco Opaco Matte White
L96	Nero Opaco Matte Black

DOLCEVITA	
SNK	Nickel Spazzolato Nickel Brushed
AL4	Bronzo Spazzolato Brushed Bronze
AL5	Oro Rosa Lucido Polished Rose Gold
GLB	Oro Spazzolato Brushed Gold
GLP	Oro Lucido Polished Gold
GMB	Gun Metal Spazzolato Brushed Gun Metal
L55	Rosa Metallizzato Metallic Pink

### VETRO / GLASS

STANDARD		
TR	Trasparente Transparent	
TG	Trasparente Grigio Transparent Grey	
ON DEMAND		
TE	Extrachiaro Extra Clear	TR +25%
RF	Fascia H.100cm Band H.100cm	TR +25%

**PORTA / DOOR**

L [cm]	COD.	A [cm]	B [cm]	C [cm]	[dm3]	[kg]	[Pcs]	V	ULU	L96	L91	DOLCEVITA
67-68	B1720	-	47	48	117	24	1	TR	1.080,00			1.405,00
								TG	1.350,00			1.755,00
68-69	B1721	-	48	49	119	24	1	TR	1.080,00			1.405,00
								TG	1.350,00			1.755,00
72-73	B1722	-	52	53	131	27	1	TR	1.100,00			1.430,00
								TG	1.375,00			1.790,00
73-74	B1723	-	53	54	133	27	1	TR	1.100,00			1.430,00
								TG	1.375,00			1.790,00
77-78	B1724	-	57	58	148	30	1	TR	1.115,00			1.450,00
								TG	1.395,00			1.815,00
78-79	B1725	-	58	59	150	30	1	TR	1.115,00			1.450,00
								TG	1.395,00			1.815,00
87-88	B1726	-	67	68	163	33	1	TR	1.135,00			1.475,00
								TG	1.420,00			1.845,00
88-89	B1727	-	68	69	165	33	1	TR	1.135,00			1.475,00
								TG	1.420,00			1.845,00
97-98	B1728	-	77	78	175	35	1	TR	1.175,00			1.530,00
								TG	1.470,00			1.910,00
98-99	B1729	-	78	79	177	35	1	TR	1.175,00			1.530,00
								TG	1.470,00			1.910,00

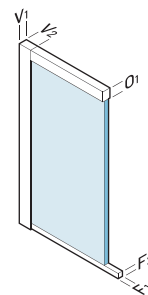

L	
V <sub>1</sub>	35mm
V <sub>2</sub>	28mm
O <sub>1</sub>	15mm
O <sub>3</sub>	15mm
O <sub>4</sub>	15mm

**PARETE FISSA / FIXED PANEL**

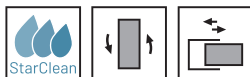
 H. 200cm  
 SP. 6mm

L1 [cm]	COD.	A [cm]	B [cm]	C [cm]	[dm3]	[kg]	[Pcs]	V	ULU	L96	L91	DOLCEVITA
67-68	B1730	-	-	-	121	24	1	TR	395,00			515,00
								TG	495,00			645,00
68-69	B1731	-	-	-	123	24	1	TR	395,00			515,00
								TG	495,00			645,00
72-73	B1732	-	-	-	126	26	1	TR	405,00			525,00
								TG	505,00			655,00
73-74	B1733	-	-	-	128	26	1	TR	405,00			525,00
								TG	505,00			655,00
77-78	B1734	-	-	-	130	28	1	TR	415,00			540,00
								TG	520,00			675,00
78-79	B1735	-	-	-	132	28	1	TR	415,00			540,00
								TG	520,00			675,00
87-88	B1736	-	-	-	142	31	1	TR	435,00			565,00
								TG	545,00			710,00
88-89	B1737	-	-	-	144	31	1	TR	435,00			565,00
								TG	545,00			710,00
97-98	B1738	-	-	-	149	33	1	TR	460,00			600,00
								TG	575,00			750,00
98-99	B1739	-	-	-	151	33	1	TR	460,00			600,00
								TG	575,00			750,00

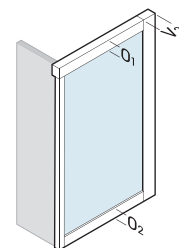

L1	
V <sub>2</sub>	28mm
O <sub>1</sub>	15mm
O <sub>2</sub>	15mm

SU MISURA/CUSTOM	PORTA DOOR	[€]	PARETE FISSA FIXED PANEL	[€]
▲▼ Altezza/Height <sup>1</sup>	150-200cm	+20%	150-200cm	+20%
◀▶ Larghezza/Width <sup>2</sup>	60-99cm	+20%	30-140cm	+20%
◆ Altezza/Height Larghezza/Width <sup>2</sup>	150-200cm 60-99cm	+20%	150-200cm 30-140cm	+20%
Altre forme Other shapes <sup>2</sup>		+30%		+30%

OPTIONAL	COD.	[€]
Profilo compensazione Compensation profile	COM11A STANDARD (+3cm)	90,00
	DOLCEVITA	120,00

<sup>1</sup> Dal prezzo della misura di riferimento/From the price of selected size

<sup>2</sup> Dal prezzo della misura superiore/From the price of the larger size

DISPONIBILITA' A MAGAZZINO / STOCK AVAILABILITY

1/2 Settimane/Weeks	2/3 Settimane/Weeks	3/4 Settimane/Weeks
---------------------	---------------------	---------------------

# PYXIS

PORTA BATTENTE PIVOT SU FISSO IN LINEA  
PIVOT HINGED DOOR ON FIXED INLINE PANEL



Per istruzioni di montaggio  
e ricambi inquadra il codice QR  
For assembly instructions  
and spare parts, scan the QR code



**H. 200cm**  
**SP. 8mm (porta/door)**  
**SP. 6mm (fissa/fixed)**



Parete doccia con apertura a porta battente pivotante su parete fissa in linea. L'apertura dell'anta è sia verso l'interno che verso l'esterno. Modello ad alto impatto estetico e disponibile in dimensioni maggiori rispetto ad una tradizionale porta.

Shower enclosure with a pivoting hinged door on a fixed inline panel. The door opens both inward and outward. A model with high aesthetic impact and available in larger sizes compared to a traditional door.

### CONFIGURAZIONE IN NICCHIA NICHE CONFIGURATION

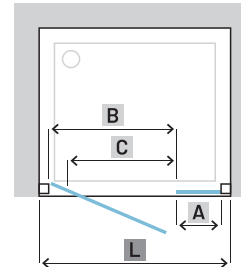

### CONFIGURAZIONI IN ANGOLO E A TRE LATI CORNER AND THREE-SIDED CONFIGURATIONS

Non è possibile realizzare configurazioni in angolo.  
Non è possibile realizzare configurazioni a tre lati.

It is not possible to create corner configurations.  
It is not possible to create three-sided configurations.

### ORIENTAMENTO E POSSIBILI COMBINAZIONI / ORIENTATION AND POSSIBLE CONFIGURATIONS

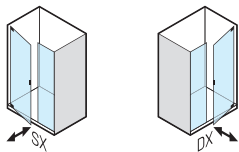

### PROFILI / PROFILES

STANDARD	
ULU	Brillantato Lucido Brilliant Polished
L91	Bianco Opaco Matte White
L96	Nero Opaco Matte Black

DOLCEVITA	
SNK	Nickel Spazzolato Nickel Brushed
AL4	Bronzo Spazzolato Brushed Bronze
AL5	Oro Rosa Lucido Polished Rose Gold
GLB	Oro Spazzolato Brushed Gold
GLP	Oro Lucido Polished Gold
GMB	Gun Metal Spazzolato Brushed Gun Metal
L55	Rosa Metallizzato Metallic Pink

### VETRO / GLASS

STANDARD	
TR	Trasparente Transparent
TG	Trasparente Grigio Transparent Grey

ON DEMAND		
TE	Extrachiaro Extra Clear	TR +25%
RF	Fascia H.100cm Band H.100cm	TR +25%

**PORTA / DOOR**

L [cm]	COD.	A [cm]	B [cm]	C [cm]	[dm <sup>3</sup> ]	[kg]	[Pcs]	V				DOLCEVITA
									ULU	L96	L91	
97-99	B1740	33	47	48	184	36	2	TR	1.415,00			1.840,00
								TG	1.770,00		2.300,00	
99-101	B1741	33	49	50	188	37	2	TR	1.415,00			1.840,00
								TG	1.770,00		2.300,00	
117-119	B1742	33	67	68	222	44	2	TR	1.475,00			1.920,00
								TG	1.845,00		2.400,00	
119-121	B1743	33	69	70	226	44	2	TR	1.475,00			1.920,00
								TG	1.845,00		2.400,00	
137-139	B1744	53	67	68	260	51	2	TR	1.510,00			1.965,00
								TG	1.890,00		2.455,00	
139-141	B1745	53	69	70	264	52	2	TR	1.510,00			1.965,00
								TG	1.890,00		2.455,00	
157-159	B1746	73	67	68	298	58	2	TR	1.560,00			2.030,00
								TG	1.950,00		2.535,00	
159-161	B1747	73	69	70	302	59	2	TR	1.560,00			2.030,00
								TG	1.950,00		2.535,00	
177-179	B1748	83	77	78	336	66	2	TR	1.590,00			2.065,00
								TG	1.990,00		2.585,00	
179-181	B1749	83	79	80	340	67	2	TR	1.590,00			2.065,00
								TG	1.990,00		2.585,00	

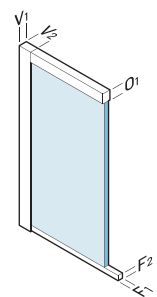

L	
V <sub>1</sub>	54mm
V <sub>2</sub>	28mm
O <sub>1</sub>	15mm
O <sub>3</sub>	15mm
O <sub>4</sub>	15mm

SU MISURA/CUSTOM	PORTA DOOR	[€]
↕ Altezza/Height <sup>1</sup>	150-200cm	+20%
↔ Larghezza/Width <sup>2</sup>	90-200cm	+20%
↕ Altezza/Height ↔ Larghezza/Width <sup>2</sup>	150-200cm 90-200cm	+20%
Altre forme Other shapes <sup>2</sup>		+30%

OPTIONAL	COD.	[€]
Profilo compensazione Compensation profile	COM11A STANDARD (+3cm) DOLCEVITA	90,00 120,00

**DISPONIBILITA' A MAGAZZINO / STOCK AVAILABILITY**

1/2 Settimane/Weeks	2/3 Settimane/Weeks	3/4 Settimane/Weeks
---------------------	---------------------	---------------------

<sup>1</sup> Dal prezzo della misura di riferimento/From the price of selected size

<sup>2</sup> Dal prezzo della misura superiore/From the price of the larger size

# PYXIS

PORTA BATTENTE PIVOT SU FISSO IN LINEA + PARETE FISSA DEDICATA  
 PIVOT HINGED DOOR ON FIXED INLINE PANEL + DEDICATED FIXED PANEL



Per istruzioni di montaggio  
 e ricambi inquadra il codice QR  
 For assembly instructions  
 and spare parts, scan the QR code



**H. 200cm**  
**SP. 8mm (porta / door)**  
**SP. 6mm (fissa / fixed)**



Parete doccia con apertura a porta battente pivotante su parete fissa in linea con parete fissa dedicata per configurazioni ad angolo. L'apertura dell'anta è sia verso l'interno che verso l'esterno. Modello ad alto impatto estetico e disponibile in dimensioni maggiori rispetto ad una tradizionale porta.

Shower enclosure with a pivoting hinged door on an inline fixed panel and a dedicated fixed panel for corner configurations. The door opens both inward and outward. A model with high aesthetic impact, available in larger sizes compared to a traditional door.

### CONFIGURAZIONE AD ANGOLO CORNER CONFIGURATION

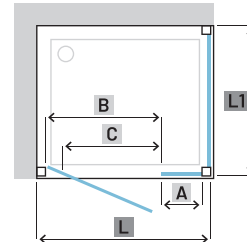

### CONFIGURAZIONI IN NICCHIA E A TRE LATI NICHE AND THREE-SIDED CONFIGURATIONS

Non è possibile realizzare configurazioni in nicchia.  
 Non è possibile realizzare configurazioni a tre lati.  
 It is not possible to create niche configurations.  
 It is not possible to create three-sided configurations.

### ORIENTAMENTO E POSSIBILI COMBINAZIONI / ORIENTATION AND POSSIBLE CONFIGURATIONS

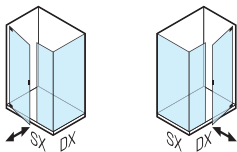

### PROFILI / PROFILES

STANDARD	
ULU	Brillantato Lucido Brilliant Polished
L91	Bianco Opaco Matte White
L96	Nero Opaco Matte Black

DOLCEVITA	
SNK	Nickel Spazzolato Nickel Brushed
AL4	Bronzo Spazzolato Brushed Bronze
AL5	Oro Rosa Lucido Polished Rose Gold
GLB	Oro Spazzolato Brushed Gold
GLP	Oro Lucido Polished Gold
GMB	Gun Metal Spazzolato Brushed Gun Metal
L55	Rosa Metallizzato Metallic Pink

### VETRO / GLASS

STANDARD		
TR	Trasparente Transparent	
TG	Trasparente Grigio Transparent Grey	
ON DEMAND		
TE	Extrachiario Extra Clear	TR +25%
RF	Fascia H.100cm Band H.100cm	TR +25%

**PORTA / DOOR**

L [cm]	COD.	A [cm]	B [cm]	C [cm]	[dm <sup>3</sup> ]	[kg]	[Pcs]	V				DOLCEVITA
									ULU	L96	L91	
97-98	B1750	34	47	48	184	36	2	TR	1.350,00			1.755,00
								TG	1.690,00		2.195,00	
98-99	B1751	34	48	49	186	36	2	TR	1.350,00			1.755,00
								TG	1.690,00		2.195,00	
117-118	B1752	34	67	68	222	44	2	TR	1.405,00			1.825,00
								TG	1.755,00		2.280,00	
118-119	B1753	34	68	69	224	44	2	TR	1.405,00			1.825,00
								TG	1.755,00		2.280,00	
137-138	B1754	54	67	68	260	51	2	TR	1.445,00			1.880,00
								TG	1.805,00		2.345,00	
138-139	B1755	54	68	69	262	51	2	TR	1.445,00			1.880,00
								TG	1.805,00		2.345,00	
157-158	B1756	74	67	68	298	58	2	TR	1.485,00			1.930,00
								TG	1.855,00		2.410,00	
158-159	B1757	74	68	69	300	59	2	TR	1.485,00			1.930,00
								TG	1.855,00		2.410,00	
177-178	B1758	84	77	78	336	66	2	TR	1.520,00			1.975,00
								TG	1.900,00		2.470,00	
178-179	B1759	84	78	79	338	66	2	TR	1.520,00			1.975,00
								TG	1.900,00		2.470,00	

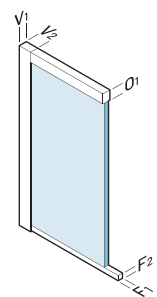

L	
V <sub>1</sub>	35mm
V <sub>2</sub>	28mm
O <sub>1</sub>	15mm
O <sub>3</sub>	15mm
O <sub>4</sub>	15mm

**PARETE FISSA / FIXED PANEL**

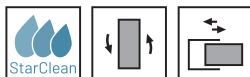
 H. 200cm  
 SP. 6mm

L1 [cm]	COD.	A [cm]	B [cm]	C [cm]	[dm <sup>3</sup> ]	[kg]	[Pcs]	V				DOLCEVITA
									ULU	L96	L91	
67-68	B1760	-	-	-	121	24	1	TR	395,00			515,00
								TG	495,00		645,00	
68-69	B1761	-	-	-	123	24	1	TR	395,00			515,00
								TG	495,00		645,00	
72-73	B1762	-	-	-	126	26	1	TR	405,00			525,00
								TG	505,00		655,00	
73-74	B1763	-	-	-	128	26	1	TR	405,00			525,00
								TG	505,00		655,00	
77-78	B1764	-	-	-	130	28	1	TR	415,00			540,00
								TG	520,00		675,00	
78-79	B1765	-	-	-	132	28	1	TR	415,00			540,00
								TG	520,00		675,00	
87-88	B1766	-	-	-	142	31	1	TR	435,00			565,00
								TG	545,00		710,00	
88-89	B1767	-	-	-	144	31	1	TR	435,00			565,00
								TG	545,00		710,00	
97-98	B1768	-	-	-	149	33	1	TR	460,00			600,00
								TG	575,00		750,00	
98-99	B1769	-	-	-	151	33	1	TR	460,00			600,00
								TG	575,00		750,00	

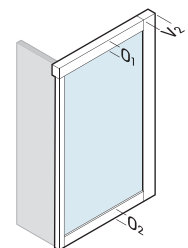

L1	
V <sub>2</sub>	28mm
O <sub>1</sub>	15mm
O <sub>2</sub>	15mm

SU MISURA/CUSTOM	PORTA DOOR	[€]	PARETE FISSA FIXED PANEL	[€]
▲▼ Altezza/Height <sup>1</sup>	150-200cm	+20%	150-200cm	+20%
◀▶ Larghezza/Width <sup>2</sup>	90-200cm	+20%	30-140cm	+20%
◆ Altezza/Height Larghezza/Width <sup>2</sup>	150-200cm 90-200cm	+20%	150-200cm 30-140cm	+20%
Altre forme Other shapes <sup>2</sup>		+30%		+30%

OPTIONAL	COD.	[€]
Profilo compensazione Compensation profile	COM11A STANDARD (+3cm) DOLCEVITA	90,00 120,00

<sup>1</sup> Dal prezzo della misura di riferimento/From the price of selected size

<sup>2</sup> Dal prezzo della misura superiore/From the price of the larger size

DISPONIBILITA' A MAGAZZINO / STOCK AVAILABILITY

1/2 Settimane/Weeks	2/3 Settimane/Weeks	3/4 Settimane/Weeks
---------------------	---------------------	---------------------

# ACRUX















- > Parete doccia con telaio parziale
- > Vetro temperato 8mm per porte scorrevoli e porte battenti pivot, 6mm per pareti fisse
- > Trattamento anticalcare StarClean di serie incluso nel prezzo
- > Estensibilità e regolazione fuori squadra del muro fino a 2cm
- > Soft closing sulle porte scorrevoli, compreso nel prezzo
- > Sgancio anta scorrevole per una agile pulizia del prodotto
- > Interasse maniglia 580 mm
- > Stampa digitale disponibile su tutti i vetri piani TR

- > Shower enclosure with partial frame
- > 8mm tempered glass for sliding doors and pivot-hinged doors, 6mm for fixed panels
- > StarClean anti-limescale treatment included in the price
- > Wall adjustment and out-of-square compensation up to 2cm
- > Soft closing on sliding doors, included in the price
- > Detachable sliding door for easy product cleaning
- > Handle centre-to-centre distance 580 mm
- > Digital printing available on all flat glasses TR

# ACRUX

## PRODOTTI DELLA SERIE / PRODUCTS OF THE SERIES

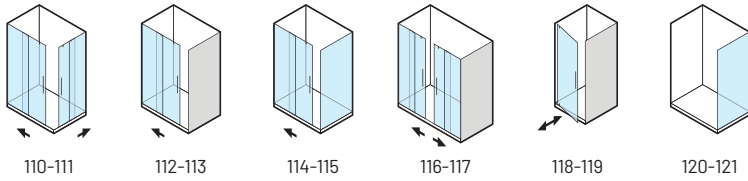

## PROFILI / PROFILES

### STANDARD

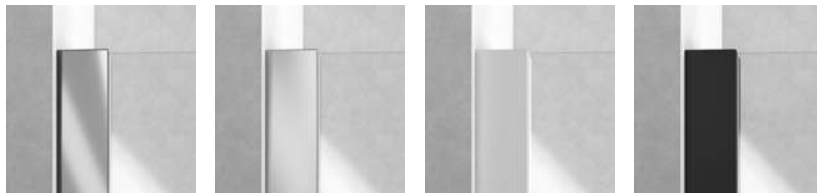

**ULU**  
Brillianto Lucido  
*Brilliant Polished*

**SAR**  
Satinato Argento  
*Silver Glazed Satin*

**L91**  
Bianco Opaco  
*Matte White*

**L96**  
Nero Opaco  
*Matte Black*

### ATELIER

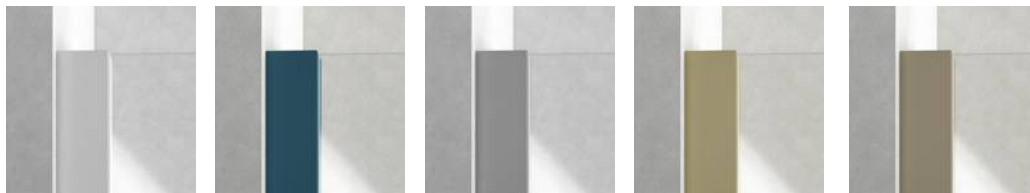

**L90**  
Artico Opaco  
*Matte Artichoke*

**L92**  
Sailor Blue Opaco  
*Matte Sailor Blue*

**L95**  
Grigio Opaco  
*Matte Grey*

**L98**  
Sabbia Opaco  
*Matte Sand*

**L99**  
Tortora Opaco  
*Matte Dove*

### DOLCEVITA



**SNK**  
Nickel Spazzolato  
*Brushed Nickel*

**AL4**  
Bronzo Spazzolato  
*Brushed Bronze*

**AL5**  
Oro Rosa Lucido  
*Polished Rose Gold*

**GLB**  
Oro Spazzolato  
*Brushed Gold*

**GLP**  
Oro Lucido  
*Polished Gold*

**GMB**  
Gun Metal Spazzolato  
*Brushed Gun Metal*

## VETRO / GLASS

### STANDARD



**TR**  
Trasparente  
*Transparent*

**TG**  
Trasparente Grigio  
*Transparent Grey*

**RF**  
Fascia H.100cm  
*Band H.100cm*

### ON DEMAND



**ST**  
Stampato  
*Printed*

**TE**  
Extrachiaro  
*Extra Clear*

**AS**  
Satinato  
*Satin*

**GS**  
Satinato grigio  
*Satin Grey*

**SY**  
Specchio  
*Mirror*

# ACRUX

LATO ANGOLO  
SIDE CORNER



Per istruzioni di montaggio  
e ricambi inquadra il codice QR  
For assembly instructions  
and spare parts, scan the QR code



**H. 200cm**  
**SP. 8mm (porta / door)**  
**SP. 6mm (fissa / fixed)**

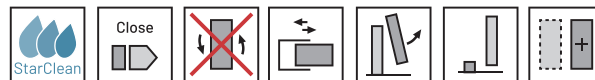

Parete doccia ad angolo a quattro ante, apertura ad ante scorrevoli nell'angolo del prodotto. Modello adatto per la maggior parte delle installazioni e disponibile in un'ampia gamma di dimensioni, soprattutto per chi vuole massimizzare le dimensioni d'ingresso.

Corner shower wall with four panels, featuring sliding doors at the corner of the product. Suitable for most installations and available in a wide range of sizes, especially for those looking to maximize the entry dimensions.

### CONFIGURAZIONE AD ANGOLO CORNER CONFIGURATION

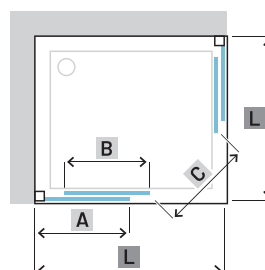

### CONFIGURAZIONI A TRE LATI THREE-SIDED CONFIGURATIONS

Per configurazioni a tre lati utilizzare la parete fissa standard AcruX nella pagina seguente.

For three-sided configurations, use the standard AcruX fixed panel on the following page.

### ORIENTAMENTO E POSSIBILI COMBINAZIONI / ORIENTATION AND POSSIBLE CONFIGURATIONS

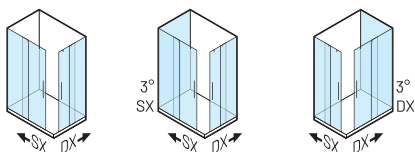

### PROFILI / PROFILES

STANDARD	
ULU	Brillantato Lucido Brilliant Polished
SAR	Satinato Argento Silver Glazed Satin
L91	Bianco Opaco Matte White
L96	Nero Opaco Matte Black

In finitura SAR, componentistica e maniglia sono in finitura cromata  
In SAR finish, the components and handle are in a chrome finish

ATELIER	
L90	Artico Opaco Matte Artic
L92	Sailor Blue Opaco Matte Sailor blue
L95	Grigio Opaco Matte Grey
L98	Sabbia Opaco Matte Sand
L99	Tortora Opaco Matte Dove

DOLCEVITA	
SNK	Nickel Spazzolato Nickel Brushed
AL4	Bronzo Spazzolato Brushed Bronze
AL5	Oro Rosa Lucido Polished Rose Gold
GLB	Oro Spazzolato Brushed Gold
GLP	Oro Lucido Polished Gold
GMB	Gun Metal Spazzolato Brushed Gun Metal

### VETRO / GLASS

STANDARD	
TR	Trasparente Transparent
TG	Trasparente Grigio Transparent Grey
RF	Fascia H.100cm Band H.100cm

ON DEMAND		
ST	Stampato Printed	TR +10%
TE	Extrachiaro Extra Clear	TR +25%
AS	Satinato Satin	TR +25%
GS	Satinato Grigio Satin Grey	TR +25%
SY	Specchio Mirror 4	TR +50%

## PORTA / DOOR

L [cm]	COD.	A [cm]	B [cm]	C [cm]	[dm <sup>3</sup> ]	[kg]	[Pcs]	V				ATELIER	DOLCEVITA
									ULU	L96	SAR L91		
67-69	B8816	32	33,3	36	80	29	1	TR	840,00			840,00	1.090,00
								TG-RF	1.050,00		1.050,00	1.365,00	
72-74	B8817	34,5	35,8	40	83	32	1	TR	860,00			860,00	1.120,00
								TG-RF	1.075,00		1.075,00	1.400,00	
77-79	B8818	37	38,3	43	87	34	1	TR	880,00			880,00	1.145,00
								TG-RF	1.100,00		1.100,00	1.430,00	
87-89	B8820	42	43,3	50	97	37	1	TR	910,00			910,00	1.185,00
								TG-RF	1.140,00		1.140,00	1.480,00	
97-99	B8821	52	43,3	51	101	40	1	TR	940,00			940,00	1.220,00
								TG-RF	1.175,00		1.175,00	1.525,00	
107-109	B8832	62	43,3	51	106	43	1	TR	985,00			985,00	1.280,00
								TG-RF	1.230,00		1.230,00	1.600,00	
117-119	B8833	72	43,3	51	123	46	1	TR	1.015,00			1.015,00	1.320,00
								TG-RF	1.270,00		1.270,00	1.650,00	

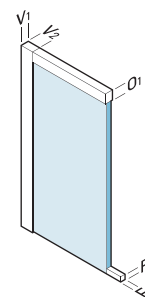

L
V <sub>1</sub> 37mm
V <sub>2</sub> 37mm
O <sub>1</sub> 37mm
F <sub>1</sub> 10mm
F <sub>2</sub> 10mm

! I valori della tabella prezzi si riferiscono ad un singolo lato: sommare l'importo dei due codici della misura desiderata per ottenere il prezzo totale di una doccia ad angolo quadrata o rettangolare. Apertura (C) determinata con due lati della stessa misura. Specificare il verso di apertura della parete doccia (/SX o /DX).

The prices in the table refer to a single side: add the amounts of the two codes for the desired size to get the total price of a square or rectangular corner shower. Opening (C) is determined by two sides of the same size. Specify the opening direction of the shower enclosure (/SX or /DX).

## PARETE FISSA / FIXED PANEL

H. 200cm  
SP. 6mm



L1 [cm]	COD.	A [cm]	B [cm]	C [cm]	[dm <sup>3</sup> ]	[kg]	[Pcs]	V				ATELIER	DOLCEVITA
									ULU	L96	SAR L91		
67-69	B8822	-	-	-	99	24	1	TR	415,00			415,00	540,00
								TG-RF	520,00		520,00	675,00	
70-72	B8823	-	-	-	105	26	1	TR	435,00			435,00	565,00
								TG-RF	545,00		545,00	705,00	
72-74	B8824	-	-	-	113	27	1	TR	450,00			450,00	585,00
								TG-RF	565,00		565,00	730,00	
77-79	B8825	-	-	-	119	29	1	TR	470,00			470,00	610,00
								TG-RF	590,00		590,00	765,00	
87-89	B8826	-	-	-	124	30	1	TR	485,00			485,00	630,00
								TG-RF	605,00		605,00	790,00	
97-99	B8827	-	-	-	129	31	1	TR	505,00			505,00	655,00
								TG-RF	630,00		630,00	820,00	

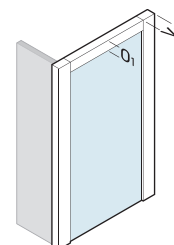

L1
V <sub>2</sub> 37mm
O <sub>1</sub> 37mm

! Utilizzare la parete fissa standard Acrux qui sopra per configurazioni a tre lati.  
Use the standard Acrux fixed panel above for three-sided configurations.

SU MISURA/CUSTOM	PORTA DOOR	[€]	PARETE FISSA FIXED PANEL	[€]
Altezza/Height <sup>1</sup>	100-210cm	+20%	150-210cm	+20%
Larghezza/Width <sup>2</sup>	60-120cm	+20%	30-140cm	+20%
Altezza/Height Larghezza/Width <sup>2</sup>	100-210cm 60-120cm	+20%	150-210cm 30-140cm	+20%
Altre forme Other shapes <sup>2</sup>		+30%		+30%

OPTIONAL	COD.	[€]
Maniglia/Handle 32cm <sup>3</sup>	L00	ULU-L91-L96
Maniglia/Handle 32cm <sup>3</sup>	N00	DOLCEVITA
Maniglia/Handle 58cm <sup>3</sup>	B00	ULU
		50,00
		105,00

<sup>1</sup> Dal prezzo della misura di riferimento / From the price of selected size

<sup>2</sup> Dal prezzo della misura superiore / From the price of the larger size

<sup>3</sup> Da richiedere al momento dell'ordine / To be requested at the time of order

<sup>4</sup> Contattare l'ufficio clienti per informazioni / Contact the customer service office for information

DISPONIBILITA' A MAGAZZINO / STOCK AVAILABILITY

1/2 Settimane/Weeks

2/3 Settimane/Weeks

3/4 Settimane/Weeks

# ACRUX

PORTA SCORREVOLE  
SLIDING DOOR



Per istruzioni di montaggio  
e ricambi inquadra il codice QR  
For assembly instructions  
and spare parts, scan the QR code



**H. 200cm**  
**SP. 8mm (porta / door)**  
**SP. 6mm (fissa / fixed)**

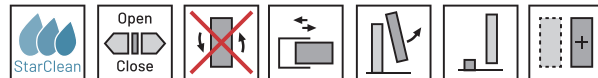

Parete doccia a due ante con apertura laterale scorrevole. Modello adatto per la maggior parte delle installazioni e disponibile in un'ampia gamma di dimensioni.

Shower wall with two panels and side sliding opening. Suitable for most installations and available in a wide range of sizes.

**CONFIGURAZIONE IN NICCHIA**  
**NICHE CONFIGURATION**

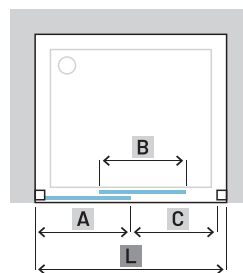

**CONFIGURAZIONE IN ANGOLO**  
**CORNER CONFIGURATION**

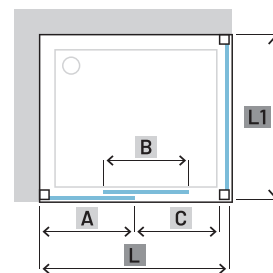

**CONFIGURAZIONI A TRE LATI**  
**THREE-SIDED CONFIGURATIONS**

Per configurazioni a tre lati utilizzare due pareti fisse standard AcruX (B8822>8827).

For three-sided configurations, use two standard AcruX fixed panels (B8822>8827).

## ORIENTAMENTO E POSSIBILI COMBINAZIONI / ORIENTATION AND POSSIBLE CONFIGURATIONS

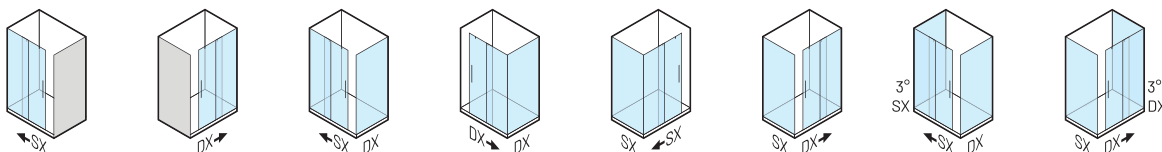

## PROFILI / PROFILES

STANDARD	
ULU	Brillantato Lucido Brilliant Polished
SAR	Satinato Argento Silver Glazed Satin
L91	Bianco Opaco Matte White
L96	Nero Opaco Matte Black

In finitura SAR, componentistica e maniglia sono in finitura cromata  
In SAR finish, the components and handle are in a chrome finish

ATELIER	
L90	Artico Opaco Matte Artic
L92	Sailor Blue Opaco Matte Sailor blue
L95	Grigio Opaco Matte Grey
L98	Sabbia Opaco Matte Sand
L99	Tortora Opaco Matte Dove

DOLCEVITA	
SNK	Nickel Spazzolato Nickel Brushed
AL4	Bronzo Spazzolato Brushed Bronze
AL5	Oro Rosa Lucido Polished Rose Gold
GLB	Oro Spazzolato Brushed Gold
GLP	Oro Lucido Polished Gold
GMB	Gun Metal Spazzolato Brushed Gun Metal

## VETRO / GLASS

STANDARD	
TR	Trasparente Transparent
TG	Trasparente Grigio Transparent Grey
RF	Fascia H.100cm Band H.100cm

ON DEMAND		
ST	Stampato Printed	TR +10%
TE	Extrachiaro Extra Clear	TR +25%
AS	Satinato Satin	TR +25%
GS	Satinato Grigio Satin Grey	TR +25%
SY	Specchio Mirror <sup>4</sup>	TR +50%

## PORTA / DOOR

L [cm]	COD.	A [cm]	B [cm]	C [cm]	[dm <sup>3</sup> ]	[kg]	[n°]	V					
									ULU	L96	SAR L91	ATELIER	DOLCEVITA
97-101	B8812	47	48	40	150	42	1	TR	1.020,00			1.020,00	1.325,00
								TG-RF	1.275,00		1.275,00	1.655,00	
107-111	B8813	52	53	45	150	47	1	TR	1.065,00			1.065,00	1.385,00
								TG-RF	1.330,00		1.330,00	1.730,00	
117-121	B8814	57	58	50	170	51	1	TR	1.105,00			1.105,00	1.435,00
								TG-RF	1.380,00		1.380,00	1.795,00	
127-131	B8815	62	63	55	200	56	2	TR	1.155,00			1.155,00	1.500,00
								TG-RF	1.445,00		1.445,00	1.875,00	
137-141	B8842	67	68	60	240	56	2	TR	1.200,00			1.200,00	1.560,00
								TG-RF	1.500,00		1.500,00	1.950,00	
147-151	B8844	72	73	65	250	61	2	TR	1.250,00			1.250,00	1.625,00
								TG-RF	1.565,00		1.565,00	2.030,00	
157-161	B8845	77	78	70	260	65	2	TR	1.305,00			1.305,00	1.695,00
								TG-RF	1.630,00		1.630,00	2.120,00	
167-171	B8843	87	78	70	260	69	2	TR	1.355,00			1.355,00	1.760,00
								TG-RF	1.695,00		1.695,00	2.200,00	
177-181	B8846	97	78	70	430	72	2	TR	1.415,00			1.415,00	1.840,00
								TG-RF	1.770,00		1.770,00	2.300,00	

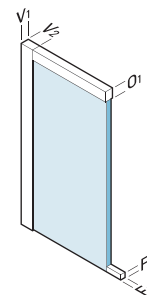

L
V <sub>1</sub> 37mm
V <sub>2</sub> 37mm
O <sub>1</sub> 37mm
F <sub>1</sub> 10mm
F <sub>2</sub> 10mm

## PARETE FISSA / FIXED PANEL

H. 200cm  
SP. 6mm



L1 [cm]	COD.	A [cm]	B [cm]	C [cm]	[dm <sup>3</sup> ]	[kg]	[Pcs]	V					
									ULU	L96	SAR L91	ATELIER	DOLCEVITA
67-69	B8822	-	-	-	99	24	1	TR	415,00			415,00	540,00
								TG-RF	520,00		520,00	675,00	
70-72	B8823	-	-	-	105	26	1	TR	435,00			435,00	565,00
								TG-RF	545,00		545,00	705,00	
72-74	B8824	-	-	-	113	27	1	TR	450,00			450,00	585,00
								TG-RF	565,00		565,00	730,00	
77-79	B8825	-	-	-	119	29	1	TR	470,00			470,00	610,00
								TG-RF	590,00		590,00	765,00	
87-89	B8826	-	-	-	124	30	1	TR	485,00			485,00	630,00
								TG-RF	605,00		605,00	790,00	
97-99	B8827	-	-	-	129	31	1	TR	505,00			505,00	655,00
								TG-RF	630,00		630,00	820,00	

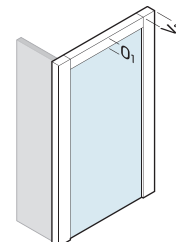

L1
V <sub>2</sub> 37mm
O <sub>1</sub> 37mm

Utilizzare la parete fissa standard Acrux qui sopra per configurazioni ad angolo ed a tre lati.  
Use the standard Acrux fixed panel above for three-sided and corner configurations.

SU MISURA/CUSTOM	PORTA DOOR	[€]	PARETE FISSA FIXED PANEL	[€]
Altezza/Height <sup>1</sup>	100-210cm	+20%	150-210cm	+20%
Larghezza/Width <sup>2</sup>	90-200cm	+20%	30-140cm	+20%
Altezza/Height Larghezza/Width <sup>2</sup>	100-210cm 90-200cm	+20%	150-210cm 30-140cm	+20%
Altre forme Other shapes <sup>2</sup>		+30%		+30%

OPTIONAL	COD.	[€]
Maniglia/Handle 32cm <sup>3</sup>	L00	ULU-L91-L96
Maniglia/Handle 32cm <sup>3</sup>	N00	DOLCEVITA
Maniglia/Handle 58cm <sup>3</sup>	B00	ULU
		50,00
		105,00

<sup>1</sup> Dal prezzo della misura di riferimento / From the price of selected size

<sup>2</sup> Dal prezzo della misura superiore / From the price of the larger size

<sup>3</sup> Da richiedere al momento dell'ordine / To be requested at the time of order

<sup>4</sup> Contattare l'ufficio clienti per informazioni / Contact the customer service office for information

DISPONIBILITA' A MAGAZZINO / STOCK AVAILABILITY

1/2 Settimane/Weeks

2/3 Settimane/Weeks

3/4 Settimane/Weeks

# ACRUX

PORTA SCORREVOLE + PARETE FISSA DEDICATA  
SLIDING DOOR + DEDICATED FIXED WALL



Per istruzioni di montaggio  
e ricambi inquadra il codice QR  
For assembly instructions  
and spare parts, scan the QR code



**H. 200cm**  
**SP. 8mm (porta / door)**  
**SP. 6mm (fissa / fixed)**

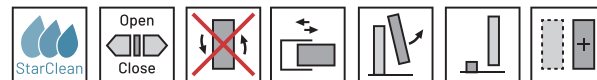

Parete doccia a due ante con apertura laterale scorrevole con parete fissa dedicata per configurazioni ad angolo. Modello adatto per la maggior parte delle installazioni e disponibile in un'ampia gamma di dimensioni.

Shower enclosure with two sliding doors and a dedicated fixed panel for corner configurations. A model suitable for most installations and available in a wide range of sizes.

### CONFIGURAZIONE AD ANGOLO CORNER CONFIGURATION

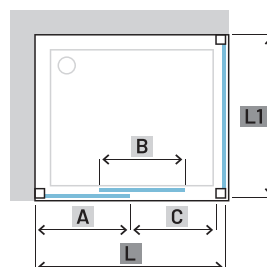

### CONFIGURAZIONI A TRE LATI THREE-SIDED CONFIGURATIONS

Per configurazioni a tre lati utilizzare una parete fissa dedicata e una parete fissa standard AcruX (B8822>8827).

For three-sided configurations, use a dedicated fixed panel and a standard AcruX fixed panel (B8822>8827).

### ORIENTAMENTO E POSSIBILI COMBINAZIONI / ORIENTATION AND POSSIBLE CONFIGURATIONS

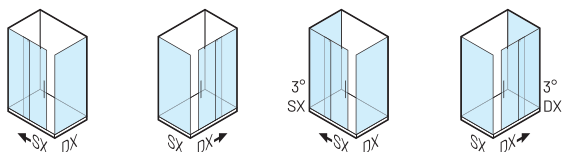

### PROFILI / PROFILES

STANDARD	
ULU	Brillantato Lucido Brilliant Polished
SAR	Satinato Argento Silver Glazed Satin
L91	Bianco Opaco Matte White
L96	Nero Opaco Matte Black

In finitura SAR, componentistica e maniglia sono in finitura cromata  
In SAR finish, the components and handle are in a chrome finish

ATELIER	
L90	Artico Opaco Matte Artic
L92	Sailor Blue Opaco Matte Sailor blue
L95	Grigio Opaco Matte Grey
L98	Sabbia Opaco Matte Sand
L99	Tortora Opaco Matte Dove

DOLCEVITA	
SNK	Nickel Spazzolato Nickel Brushed
AL4	Bronzo Spazzolato Brushed Bronze
AL5	Oro Rosa Lucido Polished Rose Gold
GLB	Oro Spazzolato Brushed Gold
GLP	Oro Lucido Polished Gold
GMB	Gun Metal Spazzolato Brushed Gun Metal

### VETRO / GLASS

STANDARD	
TR	Trasparente Transparent
TG	Trasparente Grigio Transparent Grey
RF	Fascia H.100cm Band H.100cm

ON DEMAND		
ST	Stampato Printed	TR +10%
TE	Extrachiario Extra Clear	TR +25%
AS	Satinato Satin	TR +25%
GS	Satinato Grigio Satin Grey	TR +25%
SY	Specchio Mirror <sup>4</sup>	TR +50%

## PORTA / DOOR

L [cm]	COD.	A [cm]	B [cm]	C [cm]	[dm <sup>3</sup> ]	[kg]	[Pcs]	V	SAR			ATELIER	DOLCEVITA
									ULU	L96	L91		
97-99	B8880	49	49	40	150	42	1	TR	1.020,00			1.020,00	1.325,00
								TG-RF	1.275,00		1.275,00	1.655,00	
107-109	B8881	54	54	45	150	47	1	TR	1.065,00			1.065,00	1.385,00
								TG-RF	1.330,00		1.330,00	1.730,00	
117-119	B8882	59	59	50	170	51	1	TR	1.105,00			1.105,00	1.435,00
								TG-RF	1.380,00		1.380,00	1.795,00	
127-129	B8883	64	64	55	200	56	2	TR	1.155,00			1.155,00	1.500,00
								TG-RF	1.445,00		1.445,00	1.875,00	
137-139	B8884	69	69	60	240	56	2	TR	1.200,00			1.200,00	1.560,00
								TG-RF	1.500,00		1.500,00	1.950,00	
147-149	B8885	74	74	65	250	61	2	TR	1.250,00			1.250,00	1.625,00
								TG-RF	1.565,00		1.565,00	2.030,00	
157-159	B8886	79	79	70	260	65	2	TR	1.305,00			1.305,00	1.695,00
								TG-RF	1.630,00		1.630,00	2.120,00	
167-169	B8887	89	79	70	260	69	2	TR	1.355,00			1.355,00	1.760,00
								TG-RF	1.695,00		1.695,00	2.200,00	
177-179	B8888	99	79	70	430	72	2	TR	1.415,00			1.415,00	1.840,00
								TG-RF	1.770,00		1.770,00	2.300,00	

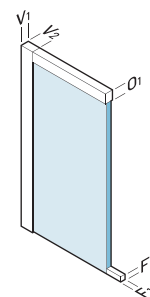

L
V <sub>1</sub> 37mm
V <sub>2</sub> 37mm
O <sub>1</sub> 37mm
F <sub>1</sub> 10mm
F <sub>2</sub> 10mm

## PARETE FISSA DEDICATA / DEDICATED FIXED PANEL

H. 200cm  
SP. 6mm



L1 [cm]	COD.	A [cm]	B [cm]	C [cm]	[dm <sup>3</sup> ]	[kg]	[Pcs]	V	SAR			ATELIER	DOLCEVITA
									ULU	L96	L91		
67-69	B8892	-	-	-	99	24	1	TR	415,00			415,00	540,00
								TG-RF	520,00		520,00	675,00	
70-72	B8893	-	-	-	105	26	1	TR	435,00			435,00	565,00
								TG-RF	545,00		545,00	705,00	
72-74	B8894	-	-	-	113	27	1	TR	450,00			450,00	585,00
								TG-RF	565,00		565,00	730,00	
77-79	B8895	-	-	-	119	29	1	TR	470,00			470,00	610,00
								TG-RF	590,00		590,00	765,00	
87-89	B8896	-	-	-	124	30	1	TR	485,00			485,00	630,00
								TG-RF	605,00		605,00	790,00	
97-99	B8897	-	-	-	129	31	1	TR	505,00			505,00	655,00
								TG-RF	630,00		630,00	820,00	

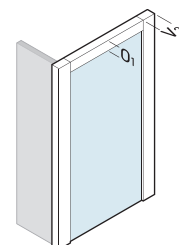

L1
V <sub>2</sub> 37mm
O <sub>1</sub> 37mm

Utilizzare la parete fissa dedicata Acrux qui sopra per configurazioni ad angolo.  
Use the dedicated Acrux fixed panel above for corner configurations.

SU MISURA/CUSTOM	PORTA DOOR	[€]	PARETE FISSA FIXED PANEL	[€]
Altezza/Height <sup>1</sup>	100-210cm	+20%	150-210cm	+20%
Larghezza/Width <sup>2</sup>	90-200cm	+20%	30-140cm	+20%
Altezza/Height Larghezza/Width <sup>2</sup>	100-210cm 90-200cm	+20%	150-210cm 30-140cm	+20%
Altre forme Other shapes <sup>2</sup>		+30%		+30%

OPTIONAL	COD.	[€]
Maniglia/Handle 32cm <sup>3</sup>	L00	ULU-L91-L96
Maniglia/Handle 32cm <sup>3</sup>	N00	DOLCEVITA
Maniglia/Handle 58cm <sup>3</sup>	B00	ULU

<sup>1</sup> Dal prezzo della misura di riferimento / From the price of selected size

<sup>2</sup> Dal prezzo della misura superiore / From the price of the larger size

<sup>3</sup> Da richiedere al momento dell'ordine / To be requested at the time of order

<sup>4</sup> Contattare l'ufficio clienti per informazioni / Contact the customer service office for information

DISPONIBILITA' A MAGAZZINO / STOCK AVAILABILITY

1/2 Settimane/Weeks

2/3 Settimane/Weeks

3/4 Settimane/Weeks

# ACRUX

DOPPIA PORTA SCORREVOLE  
DOUBLE SLIDING DOOR



Per istruzioni di montaggio  
e ricambi inquadra il codice QR  
For assembly instructions  
and spare parts, scan the QR code



**H. 200cm**  
**SP. 8mm (porta / door)**  
**SP. 6mm (fissa / fixed)**

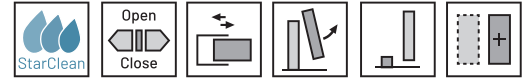

Parete doccia a quattro ante con apertura centrale. L'apertura è centrale data dalle due ante centrali scorrevoli in modo contrapposto. Modello adatto per installazioni di generose dimensioni.

Shower enclosure with four panels and a central opening. The opening is created by the two central sliding doors, which move in opposite directions. This model is suitable for large-scale installations.

**CONFIGURAZIONE IN NICCHIA**  
**NICHE CONFIGURATION**

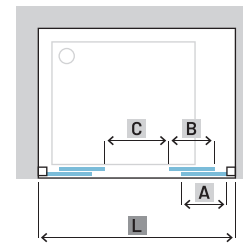

**CONFIGURAZIONE IN ANGOLO**  
**CORNER CONFIGURATION**

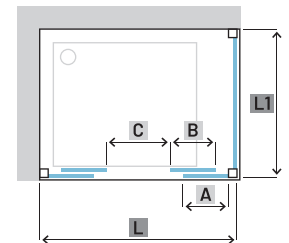

**CONFIGURAZIONI A TRE LATI**  
**THREE-SIDED CONFIGURATIONS**

Per configurazioni a tre lati utilizzare due pareti fisse standard Acruz (B8822>8827).

For three-sided configurations, use two standard Acruz fixed panels (B8822>8827).

## ORIENTAMENTO E POSSIBILI COMBINAZIONI / ORIENTATION AND POSSIBLE CONFIGURATIONS

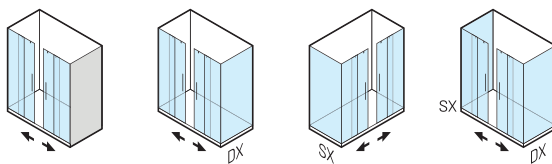

### PROFILI / PROFILES

STANDARD	
<b>ULU</b>	Brillantato Lucido Brilliant Polished
<b>SAR</b>	Satinato Argento Silver Glazed Satin
<b>L91</b>	Bianco Opaco Matte White
<b>L96</b>	Nero Opaco Matte Black

In finitura SAR, componentistica e maniglia sono in finitura cromata  
In SAR finish, the components and handle are in a chrome finish

ATELIER	
<b>L90</b>	Artico Opaco Matte Artic
<b>L92</b>	Sailor Blue Opaco Matte Sailor blue
<b>L95</b>	Grigio Opaco Matte Grey
<b>L98</b>	Sabbia Opaco Matte Sand
<b>L99</b>	Tortora Opaco Matte Dove

DOLCEVITA	
<b>SNK</b>	Nickel Spazzolato Nickel Brushed
<b>AL4</b>	Bronzo Spazzolato Brushed Bronze
<b>AL5</b>	Oro Rosa Lucido Polished Rose Gold
<b>GLB</b>	Oro Spazzolato Brushed Gold
<b>GLP</b>	Oro Lucido Polished Gold
<b>GMB</b>	Gun Metal Spazzolato Brushed Gun Metal

### VETRO / GLASS

STANDARD		
<b>TR</b>	Trasparente Transparent	
<b>TG</b>	Trasparente Grigio Transparent Grey	
<b>RF</b>	Fascia H.100cm Band H.100cm	
ON DEMAND		
<b>ST</b>	Stampato Printed	TR +10%
<b>TE</b>	Extrachiaro Extra Clear	TR +25%
<b>AS</b>	Satinato Satin	TR +25%
<b>GS</b>	Satinato Grigio Satin Grey	TR +25%
<b>SY</b>	Specchio Mirror <sup>6</sup>	TR +50%

## PORTA / DOOR

L [cm]	COD.	A [cm]	B [cm]	C [cm]	[dm <sup>3</sup> ]	[kg]	[n°]	V	SAR			ATELIER	DOLCEVITA
									ULU	L96	L91		
157-161	B8852	42	39,2	61	150	62	2	TR	1.845,00	1.845,00	2.400,00		
								TG-RF	2.305,00	2.305,00	3.000,00		
187-191	B8853	47	48,9	80	200	74	2	TR	1.885,00	1.885,00	2.450,00		
								TG-RF	2.355,00	2.355,00	3.065,00		
177-181	B8854	42	48,9	70	170	70	2	TR	1.920,00	1.920,00	2.495,00		
								TG-RF	2.400,00	2.400,00	3.120,00		
187-191	B8855	47	48,9	80	200	74	2	TR	1.960,00	1.960,00	2.550,00		
								TG-RF	2.450,00	2.450,00	3.190,00		
197-201	B8856	52	48,9	83	200	80	2	TR	2.000,00	2.000,00	2.600,00		
								TG-RF	2.500,00	2.500,00	3.250,00		

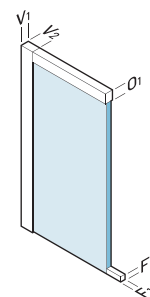

L
V <sub>1</sub> 37mm
V <sub>2</sub> 37mm
O <sub>1</sub> 37mm
F <sub>1</sub> 10mm
F <sub>2</sub> 10mm

## PARETE FISSA / FIXED PANEL

H. 200cm  
SP. 6mm



L1 [cm]	COD.	A [cm]	B [cm]	C [cm]	[dm <sup>3</sup> ]	[kg]	[Pcs]	V	SAR			ATELIER	DOLCEVITA
									ULU	L96	L91		
67-69	B8822	-	-	-	99	24	1	TR	415,00	415,00	540,00		
								TG-RF	520,00	520,00	675,00		
70-72	B8823	-	-	-	105	26	1	TR	435,00	435,00	565,00		
								TG-RF	545,00	545,00	705,00		
72-74	B8824	-	-	-	113	27	1	TR	450,00	450,00	585,00		
								TG-RF	565,00	565,00	730,00		
77-79	B8825	-	-	-	119	29	1	TR	470,00	470,00	610,00		
								TG-RF	590,00	590,00	765,00		
87-89	B8826	-	-	-	124	30	1	TR	485,00	485,00	630,00		
								TG-RF	605,00	605,00	790,00		
97-99	B8827	-	-	-	129	31	1	TR	505,00	505,00	655,00		
								TG-RF	630,00	630,00	820,00		

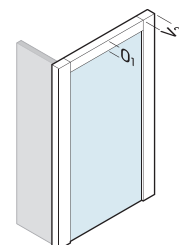

L1
V <sub>2</sub> 37mm
O <sub>1</sub> 37mm

Utilizzare la parete fissa standard Acrux qui sopra per configurazioni ad angolo ed a tre lati.  
Use the standard Acrux fixed panel above for three-sided and corner configurations.

SU MISURA/CUSTOM	PORTA DOOR	[€]	PARETE FISSA FIXED PANEL	[€]
Altezza/Height <sup>1</sup>	150-210cm	+20%	150-210cm	+20%
Larghezza/Width <sup>2</sup>	120-250cm	+20%	30-140cm	+20%
Altezza/Height Larghezza/Width <sup>2</sup>	150-210cm 120-250cm	+20%	150-210cm 30-140cm	+20%
Altre forme Other shapes <sup>2</sup>		+30%		+30%

OPTIONAL	COD.	[€]
Maniglia/Handle 32cm <sup>3</sup>	L00	ULU-L91-L96
Maniglia/Handle 32cm <sup>3</sup>	N00	DOLCEVITA
Maniglia/Handle 58cm <sup>3</sup>	B00	ULU

<sup>1</sup> Dal prezzo della misura di riferimento / From the price of selected size

<sup>2</sup> Dal prezzo della misura superiore / From the price of the larger size

<sup>3</sup> Da richiedere al momento dell'ordine / To be requested at the time of order

<sup>4</sup> Contattare l'ufficio clienti per informazioni / Contact the customer service office for information

DISPONIBILITA' A MAGAZZINO / STOCK AVAILABILITY

1/2 Settimane/Weeks

2/3 Settimane/Weeks

3/4 Settimane/Weeks

# ACRUX

PORTA BATTENTE PIVOT  
PIVOT DOOR



Per istruzioni di montaggio  
e ricambi inquadra il codice QR  
For assembly instructions  
and spare parts, scan the QR code



**H. 200cm**  
**SP. 8mm (porta / door)**  
**SP. 6mm (fissa / fixed)**

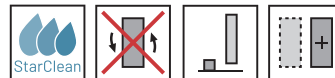

Parete doccia con apertura a porta battente pivotante. L'apertura dell'anta è sia verso l'interno che verso l'esterno. Modello adatto per situazioni che necessitano di aperture generose, ma di ingombri minimizzati all'interno del bagno.

Shower enclosure with a pivoting hinged door. The door opens both inward and outward. A model suitable for situations requiring generous openings while minimizing space usage inside the bathroom.

**CONFIGURAZIONE IN NICCHIA**  
**NICHE CONFIGURATION**

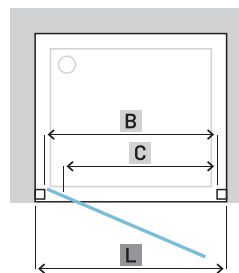

**CONFIGURAZIONE IN ANGOLO**  
**CORNER CONFIGURATION**

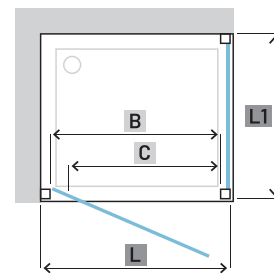

**CONFIGURAZIONI A TRE LATI**  
**THREE-SIDED CONFIGURATIONS**

Non è possibile realizzare configurazioni a tre lati.  
It is not possible to create three-sided configurations.

## ORIENTAMENTO E POSSIBILI COMBINAZIONI / ORIENTATION AND POSSIBLE CONFIGURATIONS

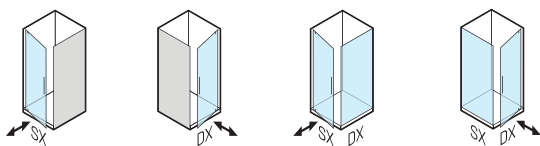

### PROFILI / PROFILES

STANDARD	
ULU	Brillantato Lucido Brilliant Polished
SAR	Satinato Argento Silver Glazed Satin
L91	Bianco Opaco Matte White
L96	Nero Opaco Matte Black

In finitura SAR, componentistica e maniglia sono in finitura cromata  
In SAR finish, the components and handle are in a chrome finish

ATELIER	
L90	Artico Opaco Matte Artic
L92	Sailor Blue Opaco Matte Sailor blue
L95	Grigio Opaco Matte Grey
L98	Sabbia Opaco Matte Sand
L99	Tortora Opaco Matte Dove

DOLCEVITA	
SNK	Nickel Spazzolato Nickel Brushed
AL4	Bronzo Spazzolato Brushed Bronze
AL5	Oro Rosa Lucido Polished Rose Gold
GLB	Oro Spazzolato Brushed Gold
GLP	Oro Lucido Polished Gold
GMB	Gun Metal Spazzolato Brushed Gun Metal

### VETRO / GLASS

STANDARD		
TR	Trasparente Transparent	
TG	Trasparente Grigio Transparent Grey	
RF	Fascia H.100cm Band H.100cm	
ON DEMAND		
ST	Stampato Printed	TR +10%
TE	Extrachiaro Extra Clear	TR +25%
AS	Satinato Satin	TR +25%
GS	Satinato Grigio Satin Grey	TR +25%
SY	Specchio Mirror <sup>6</sup>	TR +50%

## PORTA / DOOR

L [cm]	COD.	A [cm]	B [cm]	C [cm]	[dm <sup>3</sup> ]	[kg]	[n°]	V					
									ULU	L96	SAR L91	ATELIER	DOLCEVITA
67-71	B8801	5,4	51,2	53	120	31	1	TR	1.110,00			1.110,00	1.445,00
								TG-RF	1.390,00		1.390,00	1.805,00	
72-76	B8802	5,4	56,2	58	132	33	1	TR	1.130,00			1.130,00	1.470,00
								TG-RF	1.415,00		1.415,00	1.840,00	
77-81	B8803	5,4	61,2	63	132	36	1	TR	1.145,00			1.145,00	1.490,00
								TG-RF	1.430,00		1.430,00	1.865,00	
82-86	B8804	5,4	66,2	68	132	38	1	TR	1.165,00			1.165,00	1.515,00
								TG-RF	1.455,00		1.455,00	1.895,00	
87-91	B8805	5,4	71,2	73	132	40	1	TR	1.190,00			1.190,00	1.545,00
								TG-RF	1.490,00		1.490,00	1.930,00	
97-101	B8807	5,4	81,2	83	132	40	1	TR	1.205,00			1.205,00	1.565,00
								TG-RF	1.505,00		1.505,00	1.955,00	

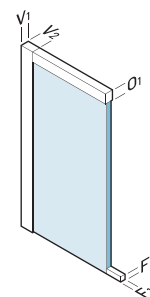

L	
V <sub>1</sub>	37mm
V <sub>2</sub>	37mm
O <sub>1</sub>	37mm
O <sub>2</sub>	37mm
F <sub>1</sub>	10mm
F <sub>2</sub>	10mm

## PARETE FISSA / FIXED PANEL

H. 200cm  
SP. 6mm



L1 [cm]	COD.	A [cm]	B [cm]	C [cm]	[dm <sup>3</sup> ]	[kg]	[Pcs]	V					
									ULU	L96	SAR L91	ATELIER	DOLCEVITA
67-69	B8822	-	-	-	99	24	1	TR	415,00			415,00	540,00
								TG-RF	520,00		520,00	675,00	
70-72	B8823	-	-	-	105	26	1	TR	435,00			435,00	565,00
								TG-RF	545,00		545,00	705,00	
72-74	B8824	-	-	-	113	27	1	TR	450,00			450,00	585,00
								TG-RF	565,00		565,00	730,00	
77-79	B8825	-	-	-	119	29	1	TR	470,00			470,00	610,00
								TG-RF	590,00		590,00	765,00	
87-89	B8826	-	-	-	124	30	1	TR	485,00			485,00	630,00
								TG-RF	605,00		605,00	790,00	
97-99	B8827	-	-	-	129	31	1	TR	505,00			505,00	655,00
								TG-RF	630,00		630,00	820,00	

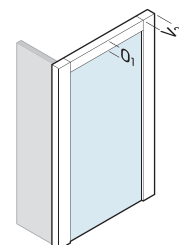

L1	
V <sub>2</sub>	37mm
O <sub>1</sub>	37mm

SU MISURA/CUSTOM	PORTA DOOR	[€]	PARETE FISSA FIXED PANEL	[€]
▲▼ Altezza/Height <sup>1</sup>	150-210cm	+20%	150-210cm	+20%
◀▶ Larghezza/Width <sup>2</sup>	60-100cm	+20%	30-140cm	+20%
◆ Altezza/Height Larghezza/Width <sup>2</sup>	150-210cm 60-100cm	+20%	150-210cm 30-140cm	+20%
Altre forme Other shapes <sup>2</sup>		+30%		+30%

OPTIONAL	COD.	[€]
Maniglia/Handle 32cm <sup>3</sup>	L00	ULU-L91-L96
Maniglia/Handle 32cm <sup>3</sup>	N00	DOLCEVITA
Maniglia/Handle 58cm <sup>3</sup>	B00	ULU
		50,00
		105,00

<sup>1</sup> Dal prezzo della misura di riferimento / From the price of selected size

<sup>2</sup> Dal prezzo della misura superiore / From the price of the larger size

<sup>3</sup> Da richiedere al momento dell'ordine / To be requested at the time of order

<sup>4</sup> Contattare l'ufficio clienti per informazioni / Contact the customer service office for information

DISPONIBILITA' A MAGAZZINO / STOCK AVAILABILITY

1/2 Settimane/Weeks

2/3 Settimane/Weeks

3/4 Settimane/Weeks

# ACRUX

PARETE FISSA  
FIXED PANEL



Per istruzioni di montaggio  
e ricambi inquadra il codice QR  
For assembly instructions  
and spare parts, scan the QR code



**H. 200cm**  
**SP. 6mm (fissa / fixed)**

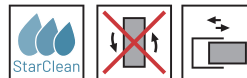

Parete fissa per abbinamenti. È possibile utilizzarla in abbinamento al modello di parete doccia selezionato per realizzare installazioni ad angolo o a tre lati quando possibile.

*Fixed panel for combinations. It can be used in combination with the selected shower enclosure model to create corner or three-sided installations where possible.*



### CONFIGURAZIONI IN ANGOLO ED A TRE LATI CORNER AND THREE-SIDED CONFIGURATIONS

È possibile realizzare configurazioni ad angolo ed a tre lati. Verificare le possibilità nelle pagine dei modelli specifici.

*It is possible to create corner and three-sided configurations; Check the options on the pages of the specific models.*

## ORIENTAMENTO E POSSIBILI COMBINAZIONI / ORIENTATION AND POSSIBLE CONFIGURATIONS

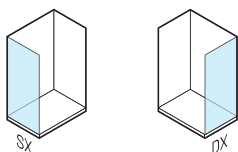

### PROFILI / PROFILES

STANDARD	
ULU	Brillantato Lucido <i>Brilliant Polished</i>
SAR	Satinato Argento <i>Silver Glazed Satin</i>
L91	Bianco Opaco <i>Matte White</i>
L96	Nero Opaco <i>Matte Black</i>

In finitura SAR, componentistica e maniglia sono in finitura cromata  
*In SAR finish, the components and handle are in a chrome finish*

ATELIER	
L90	Artico Opaco <i>Matte Artic</i>
L92	Sailor Blue Opaco <i>Matte Sailor blue</i>
L95	Grigio Opaco <i>Matte Grey</i>
L98	Sabbia Opaco <i>Matte Sand</i>
L99	Tortora Opaco <i>Matte Dove</i>

DOLCEVITA	
SNK	Nickel Spazzolato <i>Nickel Brushed</i>
AL4	Bronzo Spazzolato <i>Brushed Bronze</i>
AL5	Oro Rosa Lucido <i>Polished Rose Gold</i>
GLB	Oro Spazzolato <i>Brushed Gold</i>
GLP	Oro Lucido <i>Polished Gold</i>
GMB	Gun Metal Spazzolato <i>Brushed Gun Metal</i>

### VETRO / GLASS

STANDARD	
TR	Trasparente <i>Transparent</i>
TG	Trasparente Grigio <i>Transparent Grey</i>
RF	Fascia H.100cm <i>Band H.100cm</i>

ON DEMAND		
ST	Stampato <i>Printed</i>	TR +10%
TE	Extrachiario <i>Extra Clear</i>	TR +25%
AS	Satinato <i>Satin</i>	TR +25%
GS	Satinato Grigio <i>Satin Grey</i>	TR +25%
SY	Specchio <i>Mirror 6</i>	TR +50%

**PARETE FISSA / FIXED PANEL**

L1 [cm]	COD.	A [cm]	B [cm]	C [cm]	[dm <sup>3</sup> ]	[kg]	[Pcs]	V	SAR			ATELIER	DOLCEVITA
									ULU	L96	L91		
67-69	B8822	-	-	-	99	24	1	TR	415,00			415,00	540,00
								TG-RF	520,00		520,00	675,00	
70-72	B8823	-	-	-	105	26	1	TR	435,00			435,00	565,00
								TG-RF	545,00		545,00	705,00	
72-74	B8824	-	-	-	113	27	1	TR	450,00			450,00	585,00
								TG-RF	565,00		565,00	730,00	
77-79	B8825	-	-	-	119	29	1	TR	470,00			470,00	610,00
								TG-RF	590,00		590,00	765,00	
87-89	B8826	-	-	-	124	30	1	TR	485,00			485,00	630,00
								TG-RF	605,00		605,00	790,00	
97-99	B8827	-	-	-	129	31	1	TR	505,00			505,00	655,00
								TG-RF	630,00		630,00	820,00	

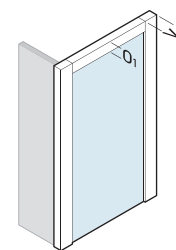

<b>L1</b>	
<b>V<sub>2</sub></b>	37mm
<b>O<sub>1</sub></b>	37mm

SU MISURA/CUSTOM	PARETE PANEL	[€]
↕ Altezza/Height <sup>1</sup>	150-210cm	+20%
↔ Larghezza/Width <sup>2</sup>	30-140cm	+20%
↕ Altezza/Height ↔ Larghezza/Width <sup>2</sup>	150-210cm 30-140cm	+20%
Altre forme Other shapes <sup>2</sup>		+30%

OPTIONAL	COD.	[€]
Maniglia/Handle 32cm <sup>3</sup>	L00	ULU-L91-L96
Maniglia/Handle 32cm <sup>3</sup>	N00	DOLCEVITA
Maniglia/Handle 58cm <sup>3</sup>	B00	ULU
		50,00
		105,00

<sup>1</sup> Dal prezzo della misura di riferimento / From the price of selected size

<sup>2</sup> Dal prezzo della misura superiore / From the price of the larger size

<sup>3</sup> Da richiedere al momento dell'ordine / To be requested at the time of order

<sup>4</sup> Contattare l'ufficio clienti per informazioni / Contact the customer service office for information

**DISPONIBILITA' A MAGAZZINO / STOCK AVAILABILITY**

1/2 Settimane/Weeks    2/3 Settimane/Weeks    3/4 Settimane/Weeks

# ZENITH



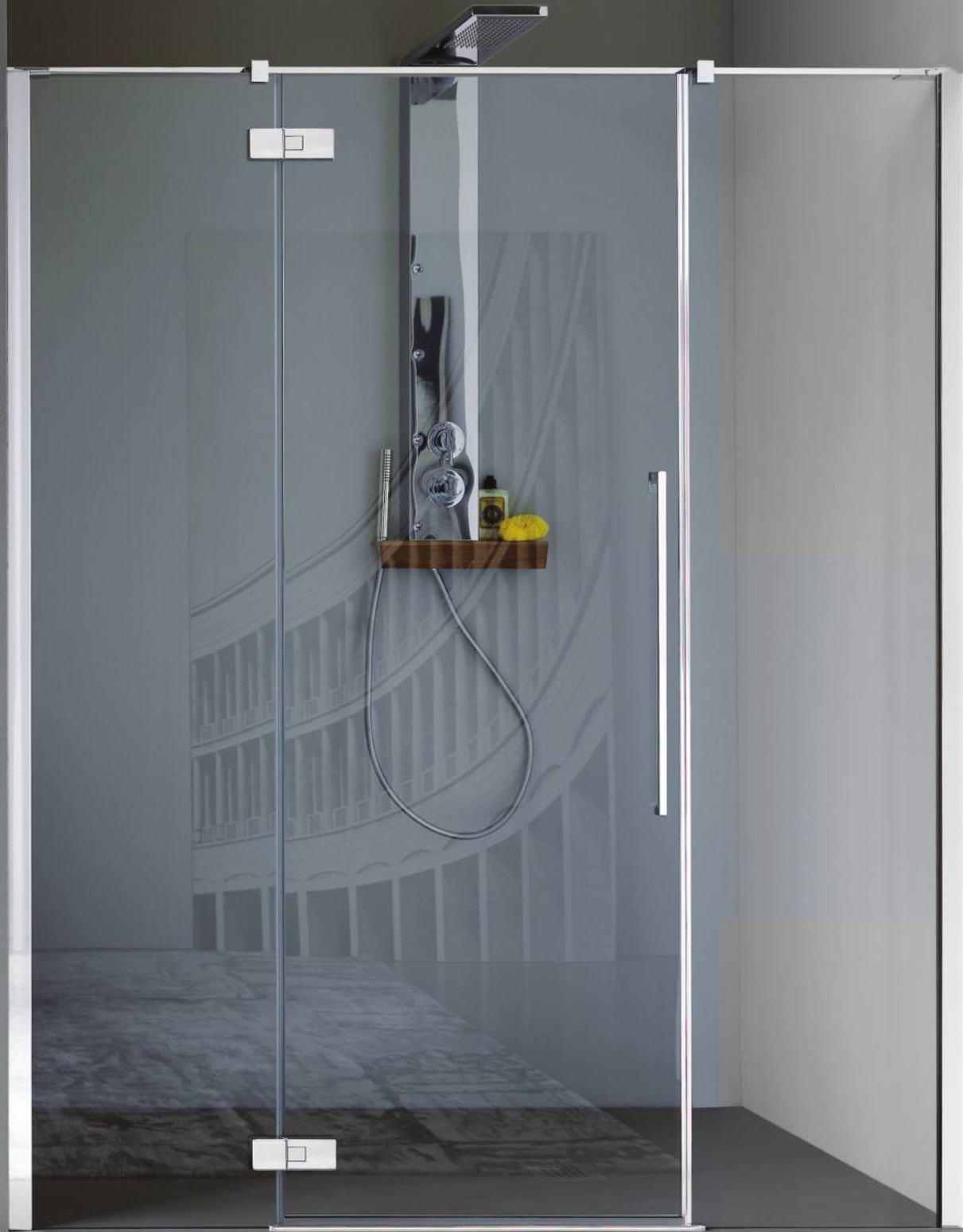







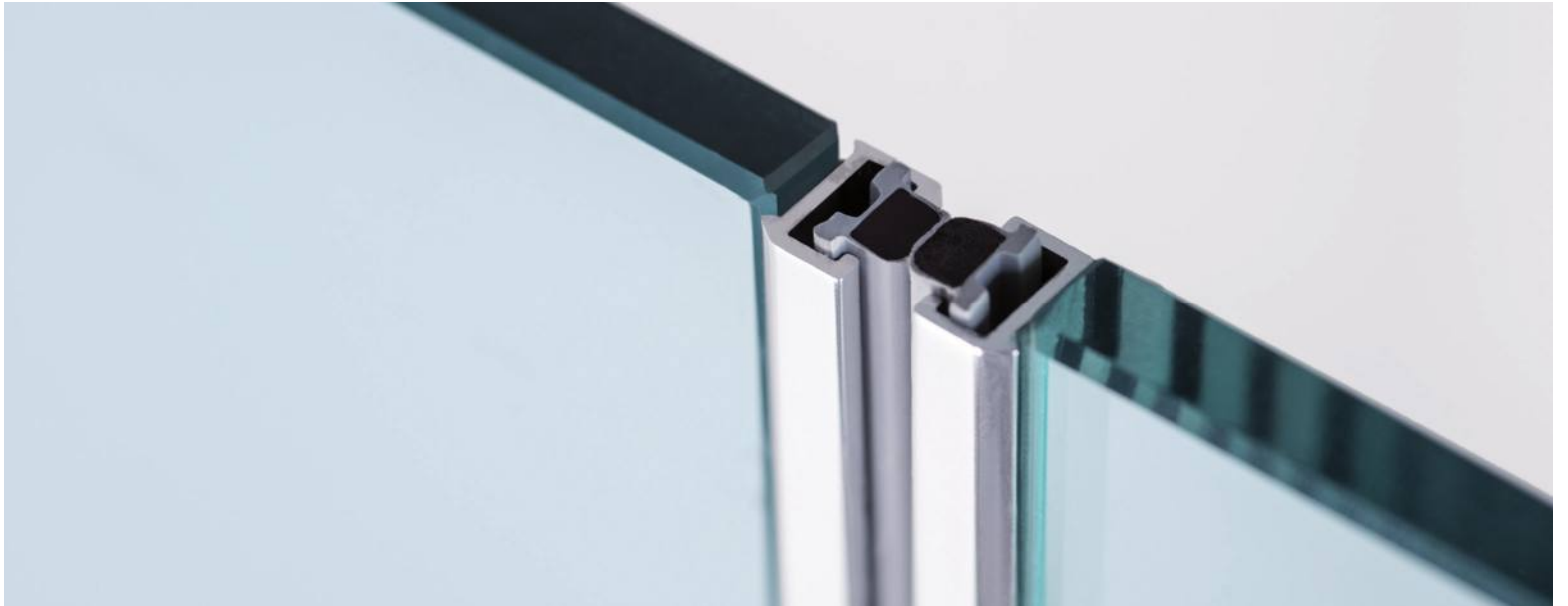



- > Parete doccia senza telaio
- > Vetro temperato 8mm per tutta la gamma
- > Trattamento anticalcare StarClean di serie incluso nel prezzo
- > Estensibilità e regolazione fuori squadra del muro fino a 2cm
- > Cerniere fissate a vetro con tecnologia di incollaggio UV
- > Sgancio anta scorrevole per una agile pulizia del prodotto
- > Interasse maniglia 580mm
- > Stampa digitale disponibile su tutti i vetri piani TR

- > *Frameless shower enclosure*
- > *8mm tempered glass across the entire range*
- > *StarClean anti-limescale treatment included in the price*
- > *Wall adjustment and out-of-square compensation up to 2cm*
- > *Hinges fixed to glass with UV bonding technology*
- > *Detachable sliding door for easy product cleaning*
- > *Handle centre-to-centre distance 580mm*
- > *Digital printing available on all flat glasses TR*

# ZENITH

## PRODOTTI DELLA SERIE / PRODUCTS OF THE SERIES

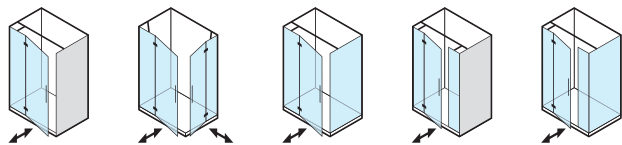

130-131

132-133

134-135

136-137

138-139

## PROFILI / PROFILES

### STANDARD

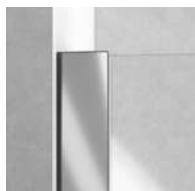

### ULU

Brillantato Lucido  
Brilliant Polished

## VETRO / GLASS

### STANDARD



### TR

Trasparente  
Transparent

### TG

Trasparente Grigio  
Transparent Grey

### ON DEMAND

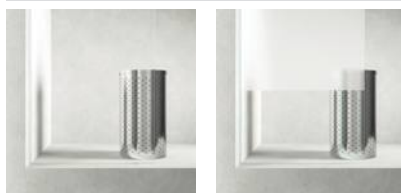

### TE

Extrachiaro  
Extra Clear

### RF

Fascia H.100cm  
Band H.100cm

# ZENITH

PORTA BATTENTE CON FISSO IN LINEA  
HINGED DOOR WITH INLINE FIXED PANEL



Per istruzioni di montaggio  
e ricambi inquadra il codice QR  
For assembly instructions  
and spare parts, scan the QR code



H. 200cm  
SP. 8mm

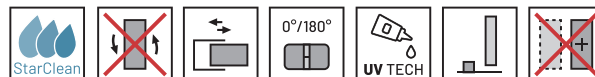

Parete doccia con apertura a porta battente con parete fissa in linea. L'apertura dell'anta è sia verso l'interno che verso l'esterno. Modello ad alto impatto estetico e disponibile in dimensioni maggiori rispetto ad una tradizionale porta.

Shower enclosure with a hinged door with a fixed inline panel. The door opens both inward and outward. A model with high aesthetic impact and available in larger sizes compared to a traditional door.

## CONFIGURAZIONE IN NICCHIA NICHE CONFIGURATION

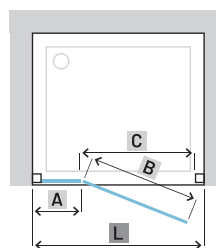

### CONFIGURAZIONI A TRE LATI THREE-SIDED CONFIGURATIONS

Non è possibile realizzare configurazioni a tre lati.  
It is not possible to create three-sided configurations.

## ORIENTAMENTO E POSSIBILI COMBINAZIONI / ORIENTATION AND POSSIBLE CONFIGURATIONS

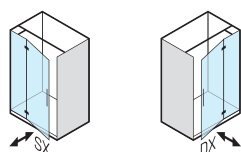

### PROFILI / PROFILES

#### STANDARD

ULU Brillantato Lucido  
Brilliant Polished

### VETRO / GLASS

#### STANDARD

TR Trasparente  
Transparent

TG Trasparente Grigio  
Transparent Grey

#### ON DEMAND

TE Extrachiaro  
Extra Clear TR +25%

RF Fascia H.100cm  
Band H.100cm TR +25%

**PORTA / DOOR**

L [cm]	COD.	A [cm]	B [cm]	C [cm]	[dm <sup>3</sup> ]	[kg]	[Pcs]	V	ULU
77,5-80,5	B9101	26,1-28,1	49	46	140	41	1	TR	1.355,00
								TG	1.695,00
87,5-90,5	B9102	29,3-31,3	56	53	158	45	1	TR	1.385,00
								TG	1.730,00
97,5-100,5	B9103	35,5-37,5	60	57	180	49	1	TR	1.415,00
								TG	1.770,00
117,5-120,5	B9105	44,3-46,3	71	68	207	68	2	TR	1.500,00
								TG	1.875,00
137,5-140,5	B9107	64,2-66,2	71	68	218	78	2	TR	1.600,00
								TG	2.000,00

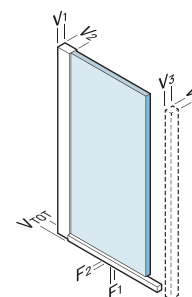

L	
V <sub>1</sub>	40mm
V <sub>2</sub>	40mm
V <sub>3</sub>	23mm
V <sub>4</sub>	23mm
V <sub>TOT</sub>	48mm
F <sub>1</sub>	9mm
F <sub>2</sub>	9mm

SU MISURA/CUSTOM	PORTA DOOR	[€]
↕ Altezza/Height <sup>1</sup>	150-217cm	+20%
↔ Larghezza/Width <sup>2</sup>	70-160cm	+20%
↕↔ Altezza/Height Larghezza/Width <sup>2</sup>	150-217cm 70-160cm	+20%
Altre forme Other shapes <sup>2</sup>		+30%

OPTIONAL	COD.	[€]
Maniglia/Handle 58cm <sup>3</sup>	B00 ULU	105,00

<sup>1</sup> Dal prezzo della misura di riferimento/From the price of selected size

<sup>2</sup> Dal prezzo della misura superiore/From the price of the larger size

<sup>3</sup> Da richiedere al momento dell'ordine/To be requested at the time of order

DISPONIBILITA' A MAGAZZINO / STOCK AVAILABILITY

1/2 Settimane/Weeks

2/3 Settimane/Weeks

3/4 Settimane/Weeks

# ZENITH

PORTA BATTENTE CON FISSO IN LINEA + PORTA BATTENTE CON FISSO IN LINEA  
HINGED DOOR WITH INLINE FIXED PANEL + HINGED DOOR WITH INLINE FIXED PANEL



Per istruzioni di montaggio  
e ricambi inquadra il codice QR  
For assembly instructions  
and spare parts, scan the QR code



**H. 200cm**  
**SP. 8mm**

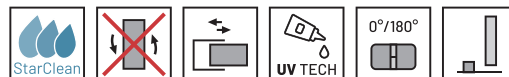

Parete doccia in configurazione ad angolo formata da due porte battenti con parete fissa in linea. L'apertura dell'anta è sia verso l'interno che verso l'esterno. Modello ad alto impatto estetico e disponibile in dimensioni maggiori rispetto ad una tradizionale porta.

Corner shower enclosure configuration consisting of two hinged doors with an inline fixed panel. The door opens both inward and outward. A model with a high aesthetic impact, available in larger sizes compared to a traditional door.

## CONFIGURAZIONE AD ANGOLO CORNER CONFIGURATION

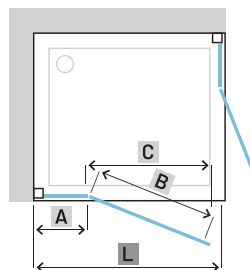

## CONFIGURAZIONI A TRE LATI THREE-SIDED CONFIGURATIONS

Non è possibile realizzare configurazioni a tre lati.  
It is not possible to create three-sided configurations.



## ORIENTAMENTO E POSSIBILI COMBINAZIONI / ORIENTATION AND POSSIBLE CONFIGURATIONS

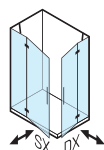

### PROFILI / PROFILES

#### STANDARD

**ULU** Brillantato Lucido  
Brilliant Polished

### VETRO / GLASS

#### STANDARD

**TR** Trasparente  
Transparent

**TG** Trasparente Grigio  
Transparent Grey

#### ON DEMAND

**TE** Extrachiaro  
Extra Clear TR +25%

**RF** Fascia H.100cm  
Band H.100cm TR +25%

## PORTA / DOOR

L [cm]	COD.	L NOM. [cm]	A [cm]	B [cm]	C [cm]	[dm <sup>3</sup> ]	[kg]	[Pcs]	V	ULU
77,5-79,5	<b>B9111</b>	76-78	26,1-28,1	49	65	140	41	1	TR	1.315,00
									TG	1.645,00
87,5-89,5	<b>B9112</b>	86-88	29,3-31,3	56	74	158	45	1	TR	1.340,00
									TG	1.675,00
97,5-99,5	<b>B9113</b>	96-98	35,5-37,5	60	80	180	49	1	TR	1.400,00
									TG	1.750,00
117,5-119,5	<b>B9115</b>	116-118	44,3-46,3	71	96	207	68	2	TR	1.485,00
									TG	1.855,00

**I** I valori della tabella prezzi si riferiscono ad un singolo lato: sommare l'importo dei due codici della misura desiderata per ottenere il prezzo totale di una doccia ad angolo quadrata o rettangolare. Apertura (C) determinata con due lati della stessa misura. Specificare il verso di apertura della parete doccia (/SX o /DX).

The prices in the table refer to a single side: add the amounts of the two codes for the desired size to get the total price of a square or rectangular corner shower. Opening (C) is determined by two sides of the same size. Specify the opening direction of the shower enclosure (/SX or /DX).

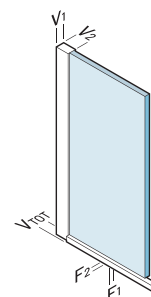

L	
V <sub>1</sub>	40mm
V <sub>2</sub>	40mm
V <sub>TOT</sub>	48mm
F <sub>1</sub>	9mm
F <sub>2</sub>	9mm

SU MISURA/CUSTOM	PORTA DOOR	[€]
↕ Altezza/Height <sup>1</sup>	150-217cm	+20%
↔ Larghezza/Width <sup>2</sup>	70-160cm	+20%
↕↔ Altezza/Height Larghezza/Width <sup>2</sup>	150-217cm 70-160cm	+20%
Altre forme Other shapes <sup>2</sup>		+30%

OPTIONAL	COD.	[€]
Maniglia/Handle 58cm <sup>3</sup>	<b>B00</b> ULU	105,00

<sup>1</sup> Dal prezzo della misura di riferimento/From the price of selected size

<sup>2</sup> Dal prezzo della misura superiore/From the price of the larger size

<sup>3</sup> Da richiedere al momento dell'ordine/To be requested at the time of order

DISPONIBILITA' A MAGAZZINO / STOCK AVAILABILITY

1/2 Settimane/Weeks

2/3 Settimane/Weeks

3/4 Settimane/Weeks

# ZENITH

PORTA BATTENTE CON FISSO IN LINEA + PARETE FISSA DEDICATA  
HINGED DOOR WITH INLINE FIXED PANEL + DEDICATED FIXED PANEL



Per istruzioni di montaggio  
e ricambi inquadra il codice QR  
For assembly instructions  
and spare parts, scan the QR code



H. 200cm  
SP. 8mm

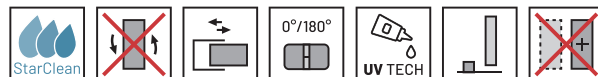

Parete doccia in configurazione ad angolo formata da porta battente con parete fissa in linea più parete fissa. L'apertura dell'anta è sia verso l'interno che verso l'esterno. Modello ad alto impatto estetico e disponibile in dimensioni maggiori rispetto ad una tradizionale porta.

Corner shower enclosure configuration consisting of a hinged door with an inline fixed panel and an additional fixed panel. The door opens both inward and outward. A model with a high aesthetic impact, available in larger sizes compared to a traditional door.

## CONFIGURAZIONE AD ANGOLO CORNER CONFIGURATION

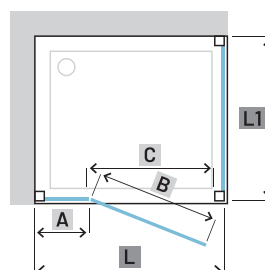

### CONFIGURAZIONI A TRE LATI THREE-SIDED CONFIGURATIONS

Non è possibile realizzare configurazioni a tre lati.  
It is not possible to create three-sided configurations.



## ORIENTAMENTO E POSSIBILI COMBINAZIONI / ORIENTATION AND POSSIBLE CONFIGURATIONS

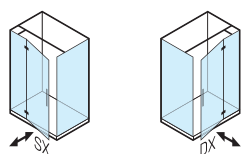

### PROFILI / PROFILES

#### STANDARD

**ULU** Brillantato Lucido  
Brilliant Polished

### VETRO / GLASS

#### STANDARD

**TR** Trasparente  
Transparent

**TG** Trasparente Grigio  
Transparent Grey

#### ON DEMAND

**TE** Extrachiaro  
Extra Clear TR +25%

**RF** Fascia H.100cm  
Band H.100cm TR +25%

## PORTA / DOOR

L [cm]	COD.	L NOM. [cm]	A [cm]	B [cm]	C [cm]	[dm <sup>3</sup> ]	[kg]	[Pcs]	V	ULU
76,7-78,7	B9121	76-78	26,1-28,1	49	46	140	41	1	TR	1.355,00
									TG	1.695,00
86,7-88,7	B9122	86-88	29,3-31,3	56	53	158	45	1	TR	1.385,00
									TG	1.730,00
96,7-98,7	B9123	96-98	35,5-36,5	60	57	180	49	1	TR	1.415,00
									TG	1.770,00
116,7-118,7	B9125	116-118	44,3-46,3	71	68	207	68	2	TR	1.500,00
									TG	1.875,00
136,7-138,7	B9127	136-138	64,2-66,2	71	68	218	76	2	TR	1.600,00
									TG	2.000,00

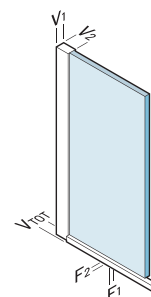

L
V <sub>1</sub> 40mm
V <sub>2</sub> 40mm
V <sub>TOT</sub> 48mm
F <sub>1</sub> 9mm
F <sub>2</sub> 9mm

## PARETE FISSA DEDICATA / DEDICATED FIXED PANEL

H. 200cm  
SP. 8mm

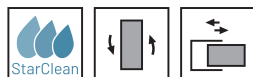

L1 [cm]	COD.	L NOM. [cm]	A [cm]	B [cm]	C [cm]	[dm <sup>3</sup> ]	[kg]	[Pcs]	V	ULU
67,5-69,5	B9150	66-68	-	-	-	128	37	1	TR	865,00
									TG	1.080,00
77,5-79,5	B9151	76-78	-	-	-	146	41	1	TR	865,00
									TG	1.080,00
87,5-89,5	B9152	86-88	-	-	-	166	45	1	TR	890,00
									TG	1.115,00
97,5-99,5	B9153	96-98	-	-	-	182	49	1	TR	920,00
									TG	1.150,00

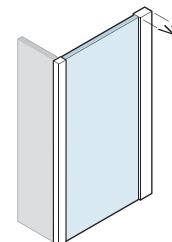

L1
V <sub>2</sub> 40mm

SU MISURA/CUSTOM	PORTA DOOR	[€]	PARETE FISSA FIXED PANEL	[€]
↕ Altezza/Height <sup>1</sup>	150-217cm	+20%	50-217cm	+20%
↔ Larghezza/Width <sup>2</sup>	70-160cm	+20%	50-140cm	+20%
↕ Altezza/Height ↔ Larghezza/Width <sup>2</sup>	150-217cm 70-160cm	+20%	50-217cm 50-140cm	+20%
Altre forme Other shapes <sup>2</sup>		+30%		+30%

OPTIONAL	COD.	[€]
Maniglia/Handle 58cm <sup>3</sup>	B00 ULU	105,00

<sup>1</sup> Dal prezzo della misura di riferimento/From the price of selected size

<sup>2</sup> Dal prezzo della misura superiore/From the price of the larger size

<sup>3</sup> Da richiedere al momento dell'ordine/To be requested at the time of order

DISPONIBILITA' A MAGAZZINO / STOCK AVAILABILITY

1/2 Settimane/Weeks

2/3 Settimane/Weeks

3/4 Settimane/Weeks

# ZENITH

PORTA BATTENTE CON 2 FISSI IN LINEA  
HINGED DOOR WITH 2 INLINE FIXED PANELS



Per istruzioni di montaggio  
e ricambi inquadra il codice QR  
For assembly instructions  
and spare parts, scan the QR code



H. 200cm  
SP. 8mm

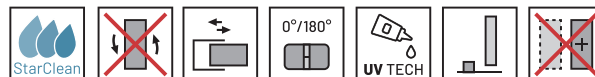

Parete doccia con apertura a porta battente con doppia parete fissa in linea. L'apertura dell'anta è sia verso l'interno che verso l'esterno. Modello ad alto impatto estetico e disponibile in dimensioni maggiori rispetto ad una tradizionale porta.

Shower enclosure with a hinged door and two inline fixed panels. The door opens both inward and outward. A model with a high aesthetic impact, available in larger sizes compared to a traditional door.

## CONFIGURAZIONE IN NICCHIA NICHE CONFIGURATION

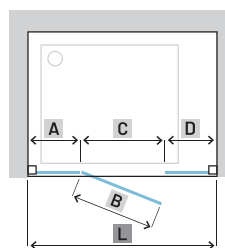

## CONFIGURAZIONI A TRE LATI THREE-SIDED CONFIGURATIONS

Non è possibile realizzare configurazioni a tre lati.  
It is not possible to create three-sided configurations.



## ORIENTAMENTO E POSSIBILI COMBINAZIONI / ORIENTATION AND POSSIBLE CONFIGURATIONS

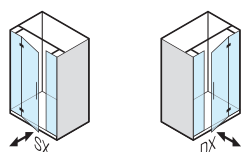

### PROFILI / PROFILES

#### STANDARD

ULU Brillantato Lucido  
Brilliant Polished

### VETRO / GLASS

#### STANDARD

TR Trasparente  
Transparent

TG Trasparente Grigio  
Transparent Grey

#### ON DEMAND

TE Extrachiaro  
Extra Clear TR +25%

RF Fascia H.100cm  
Band H.100cm TR +25%

**PORTA / DOOR**

L [cm]	COD.	A [cm]	B [cm]	C [cm]	D [cm]	[dm <sup>3</sup> ]	[kg]	[Pcs]	V	ULU
116-120	<b>B9182</b>	30,1-32,1	56	53	30,1-32,1	207	68	2	TR TG	1.925,00 2.405,00
136-140	<b>B9184</b>	35,5-37,5	65	62	35,5-37,5	218	76	2	TR TG	2.000,00 2.500,00
146-150	<b>B9185</b>	40,5-42,5	65	62	40,5-42,5	223	80	2	TR TG	2.095,00 2.620,00
166-170	<b>B9187</b>	47,6-49,6	71	68	47,6-49,6	242	88	2	TR TG	2.215,00 2.770,00

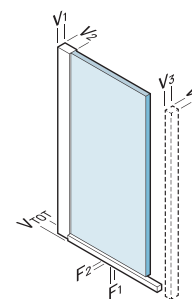

L	
V <sub>1</sub>	40mm
V <sub>2</sub>	40mm
V <sub>3</sub>	23mm
V <sub>4</sub>	23mm
V <sub>TOT</sub>	48mm
F <sub>1</sub>	9mm
F <sub>2</sub>	9mm

SU MISURA/CUSTOM	PORTA DOOR	[€]
↕ Altezza/Height <sup>1</sup>	150-217cm	+20%
↔ Larghezza/Width <sup>2</sup>	100-210cm	+20%
↕ Altezza/Height ↔ Larghezza/Width <sup>2</sup>	150-217cm 100-210cm	+20%
Altre forme Other shapes <sup>2</sup>		+30%

OPTIONAL	COD.	[€]
Maniglia/Handle 58cm <sup>3</sup>	<b>B00</b> ULU	105,00

<sup>1</sup> Dal prezzo della misura di riferimento/From the price of selected size

<sup>2</sup> Dal prezzo della misura superiore/From the price of the larger size

<sup>3</sup> Da richiedere al momento dell'ordine/To be requested at the time of order

**DISPONIBILITA' A MAGAZZINO / STOCK AVAILABILITY**
**1/2** Settimane/Weeks

**2/3** Settimane/Weeks

**3/4** Settimane/Weeks

# ZENITH

PORTA BATTENTE CON 2 FISSI IN LINEA + PARETE FISSA DEDICATA  
HINGED DOOR WITH 2 INLINE FIXED PANELS + DEDICATED FIXED PANEL



Per istruzioni di montaggio  
e ricambi inquadra il codice QR  
For assembly instructions  
and spare parts, scan the QR code



H. 200cm  
SP. 8mm

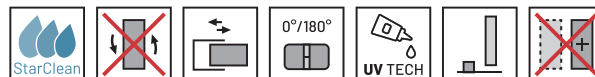

Parete doccia in configurazione ad angolo formata da porta battente con doppia parete fissa in linea più parete fissa. L'apertura dell'anta è sia verso l'interno che verso l'esterno. Modello ad alto impatto estetico e disponibile in dimensioni maggiori rispetto ad una tradizionale porta.

Corner shower enclosure configuration consisting of a hinged door with two inline fixed panels and an additional fixed panel. The door opens both inward and outward. A model with a high aesthetic impact, available in larger sizes compared to a traditional door.

## CONFIGURAZIONE AD ANGOLO CORNER CONFIGURATION

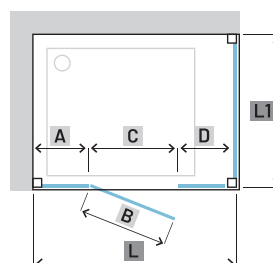

### CONFIGURAZIONI A TRE LATI THREE-SIDED CONFIGURATIONS

Non è possibile realizzare configurazioni a tre lati.  
It is not possible to create three-sided configurations.



## ORIENTAMENTO E POSSIBILI COMBINAZIONI / ORIENTATION AND POSSIBLE CONFIGURATIONS

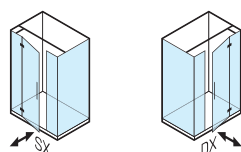

### PROFILI / PROFILES

#### STANDARD

ULU Brillantato Lucido  
Brilliant Polished

### VETRO / GLASS

#### STANDARD

TR Trasparente  
Transparent

TG Trasparente Grigio  
Transparent Grey

#### ON DEMAND

TE Extrachiaro  
Extra Clear TR +25%

RF Fascia H.100cm  
Band H.100cm TR +25%

## PORTA / DOOR

L [cm]	COD.	L NOM. [cm]	A [cm]	B [cm]	C [cm]	D [cm]	[dm <sup>3</sup> ]	[kg]	[Pcs]	V	ULU
116,7-118,7	<b>B9182</b>	116-120	30,1-32,1	56	53	30,1-32,1	207	68	2	TR TG	1.925,00 2.405,00
136,7-138,7	<b>B9184</b>	136-140	35,5-37,5	65	62	35,5-37,5	218	76	2	TR TG	2.000,00 2.500,00
146,7-148,7	<b>B9185</b>	146-150	40,5-42,5	65	62	40,5-42,5	223	80	2	TR TG	2.095,00 2.620,00
166,7-168,7	<b>B9187</b>	166-170	47,6-49,6	71	68	47,6-49,6	242	88	2	TR TG	2.215,00 2.770,00

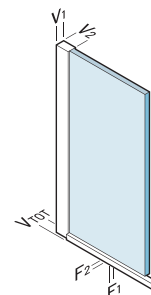

L
V <sub>1</sub> 40mm
V <sub>2</sub> 40mm
V <sub>TOT</sub> 48mm
F <sub>1</sub> 9mm
F <sub>2</sub> 9mm

## PARETE FISSA / FIXED PANEL

H. 200cm  
SP. 8mm

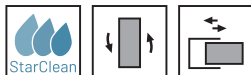

L1 [cm]	COD.	L NOM. [cm]	A [cm]	B [cm]	C [cm]	D [cm]	[dm <sup>3</sup> ]	[kg]	[Pcs]	V	ULU
67,5-69,5	<b>B9170</b>	66-68	-	-	-	-	128	37	1	TR TG	865,00 1.080,00
77,5-79,5	<b>B9171</b>	76-78	-	-	-	-	146	41	1	TR TG	865,00 1.080,00
87,5-89,5	<b>B9172</b>	86-88	-	-	-	-	166	45	1	TR TG	890,00 1.115,00
97,5-99,5	<b>B9173</b>	96-98	-	-	-	-	182	49	1	TR TG	920,00 1.150,00

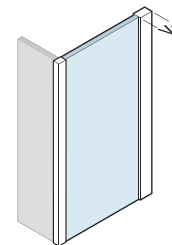

L1
V <sub>2</sub> 40mm

SU MISURA/CUSTOM	PORTA DOOR	[€]	PARETE FISSA FIXED PANEL	[€]
▲▼ Altezza/Height <sup>1</sup>	150-217cm	+20%	50-217cm	+20%
◀▶ Larghezza/Width <sup>2</sup>	100-210cm	+20%	50-140cm	+20%
◆ Altezza/Height Larghezza/Width <sup>2</sup>	150-217cm 100-210cm	+20%	50-217cm 50-140cm	+20%
Altre forme Other shapes <sup>2</sup>		+30%		+30%

OPTIONAL	COD.	[€]
Maniglia/Handle 58cm <sup>3</sup>	<b>B00</b> ULU	105,00

<sup>1</sup> Dal prezzo della misura di riferimento/From the price of selected size

<sup>2</sup> Dal prezzo della misura superiore/From the price of the larger size

<sup>3</sup> Da richiedere al momento dell'ordine/To be requested at the time of order

DISPONIBILITÀ A MAGAZZINO / STOCK AVAILABILITY

1/2 Settimane/Weeks

2/3 Settimane/Weeks

3/4 Settimane/Weeks

# POLARIS















- > Parete doccia senza telaio
- > Vetro temperato 6mm per tutta la gamma
- > Trattamento anticalcare StarClean disponibile su richiesta
- > Estensibilità e regolazione fuori squadra del muro fino a 2cm
- > Interasse maniglia 160mm
- > Stampa digitale disponibile su tutti i vetri piani TR

- > *Frameless shower enclosure*
- > *6mm tempered glass across the entire range*
- > *StarClean anti-limescale treatment available upon request*
- > *Wall adjustment and out-of-square compensation up to 2cm*
- > *Handle centre-to-centre distance 160mm*
- > *Digital printing available on all flat glasses TR*

# POLARIS

## PRODOTTI DELLA SERIE / PRODUCTS OF THE SERIES

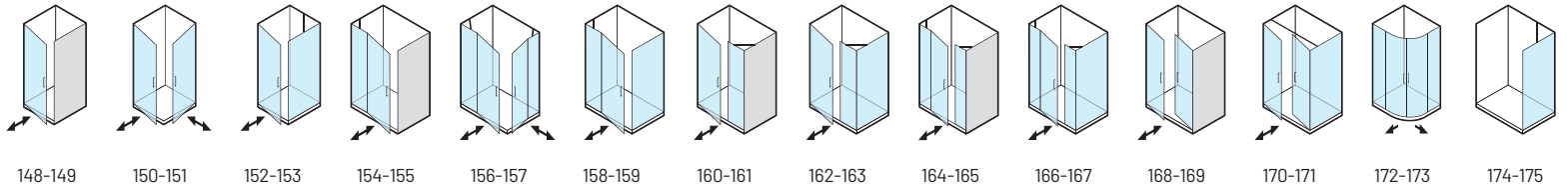

## PROFILI / PROFILES

### STANDARD



**ULU**  
Brillianto Lucido  
Brilliant Polished

**L91**  
Bianco Opaco  
Matte White

**L96**  
Nero Opaco  
Matte Black

### DOLCEVITA



**SNK**  
Nickel Spazzolato  
Brushed Nickel

**AL4**  
Bronzo Spazzolato  
Brushed Bronze

**AL5**  
Oro Rosa Lucido  
Polished Rose Gold

**GLB**  
Oro Spazzolato  
Brushed Gold

**GLP**  
Oro Lucido  
Polished Gold

**GMB**  
Gun Metal Spazzolato  
Brushed Gun Metal

## VETRO / GLASS

### STANDARD



**TR**  
Trasparente  
Transparent

**AS**  
Satinato  
Satin

**RF**  
Fascia H.100cm  
Band H.100cm

### ON DEMAND



**ST**  
Stampato  
Printed

**TE**  
Extrachiaro  
Extra Clear

**TG**  
Trasparente Grigio  
Transparent Grey

**GS**  
Satinato grigio  
Satin Grey

**SY**  
Specchio  
Mirror

# POLARIS

PORTA BATTENTE  
HINGED DOOR



Per istruzioni di montaggio  
e ricambi inquadra il codice QR  
For assembly instructions  
and spare parts, scan the QR code



**H. 195cm**  
**SP. 6mm**

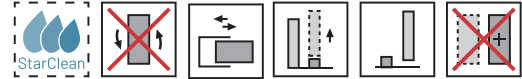

Parete doccia con apertura a porta battente. L'apertura dell'anta è sia verso l'interno che verso l'esterno. Modello adatto per situazioni che necessitano della massima apertura possibile.

Shower enclosure with a hinged door. The door opens both inward and outward. A model suitable for situations requiring the maximum possible opening.

## CONFIGURAZIONE IN NICCHIA NICHE CONFIGURATION

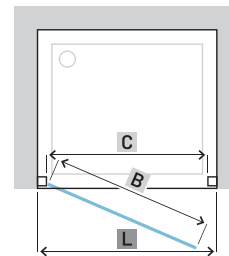

## CONFIGURAZIONI IN ANGOLO E A TRE LATI CORNER AND THREE-SIDED CONFIGURATIONS

Non è possibile realizzare configurazioni in angolo.  
Non è possibile realizzare configurazioni a tre lati.  
It is not possible to create corner configurations.  
It is not possible to create three-sided configurations.

## ORIENTAMENTO E POSSIBILI COMBINAZIONI / ORIENTATION AND POSSIBLE CONFIGURATIONS

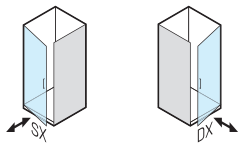

### PROFILI / PROFILES

STANDARD	
ULU	Brillantato Lucido Brilliant Polished
L91	Bianco Opaco Matte White
L96	Nero Opaco Matte Black

DOLCEVITA	
SNK	Nickel Spazzolato Nickel Brushed
AL4	Bronzo Spazzolato Brushed Bronze
AL5	Oro Rosa Lucido Polished Rose Gold
GLB	Oro Spazzolato Brushed Gold
GLP	Oro Lucido Polished Gold
GMB	Gun Metal Spazzolato Brushed Gun Metal

### VETRO / GLASS

STANDARD		
TR	Trasparente Transparent	
AS	Satinato Satin	
RF	Fascia H.100cm Band H.100cm	
ON DEMAND		
ST	Stampato Printed	TR +10%
TE	Extrachiario Extra Clear	TR +25%
TG	Trasparente Grigio Transparent Grey	TR +25%
GS	Satinato Grigio Satin Grey	TR +25%
SY	Specchio Mirror <sup>4</sup>	TR +50%

**PORTA / DOOR**

L [cm]	COD.	B [cm]	C [cm]	[dm <sup>3</sup> ]	[kg]	[n°]	V			
								ULU	L96	L91
67-70	B3930	60,4	59	116	25	1	TR	540,00	700,00	
							AS-RF	675,00	875,00	
70-73	B3931	63,2	62	125	27	1	TR	545,00	710,00	
							AS-RF	680,00	890,00	
73-76	B3932	66,4	65	131	28	1	TR	555,00	720,00	
							AS-RF	695,00	900,00	
77-80	B3933	70,4	69	133	29	1	TR	560,00	730,00	
							AS-RF	700,00	915,00	
80-83	B3934	73,2	72	142	30	1	TR	570,00	740,00	
							AS-RF	715,00	925,00	
83-86	B3935	76,4	75	145	31	1	TR	575,00	750,00	
							AS-RF	720,00	940,00	
87-90	B3936	80,4	79	152	32	1	TR	585,00	760,00	
							AS-RF	730,00	950,00	
97-100	B3937	90,4	89	159	33	1	TR	585,00	760,00	
							AS-RF	730,00	950,00	

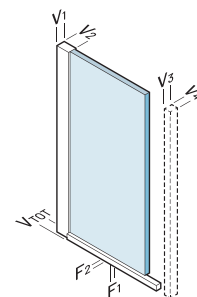

L	
V <sub>1</sub>	35mm
V <sub>2</sub>	38mm
V <sub>3</sub>	24mm
V <sub>4</sub>	23mm
V <sub>TOT</sub>	39mm
F <sub>1</sub>	9mm
F <sub>2</sub>	9mm

SU MISURA/CUSTOM	PORTA DOOR	[€]
▲▼ Altezza/Height <sup>1</sup>	145-217cm	+20%
◀▶ Larghezza/Width <sup>2</sup>	45-100cm	+20%
◆ Altezza/Height Larghezza/Width <sup>2</sup>	145-217cm 45-100cm	+20%
Altre forme Other shapes <sup>2</sup>		+30%

OPTIONAL	COD.	[€]
Maniglia/Handle 16cm <sup>3</sup>	H00	40,00
Maniglia/Handle 32cm <sup>3</sup>	L00	50,00
Maniglia/Handle 32cm <sup>3</sup>	N00	50,00
 StarClean	Porta/Door	50,00

<sup>1</sup> Dal prezzo della misura di riferimento / From the price of selected size

<sup>2</sup> Dal prezzo della misura superiore / From the price of the larger size

<sup>3</sup> Da richiedere al momento dell'ordine / To be requested at the time of order

<sup>4</sup> Contattare l'ufficio clienti per informazioni / Contact the customer service office for information

**DISPONIBILITA' A MAGAZZINO / STOCK AVAILABILITY**
**1/2** Settimane/Weeks

**2/3** Settimane/Weeks

**3/4** Settimane/Weeks

# POLARIS

PORTA BATTENTE + PORTA BATTENTE  
HINGED DOOR + HINGED DOOR



Per istruzioni di montaggio  
e ricambi inquadra il codice QR  
For assembly instructions  
and spare parts, scan the QR code



H. 195cm  
SP. 6mm

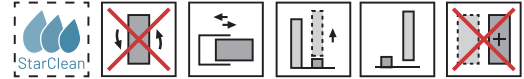

Parete doccia in configurazione ad angolo formata da due porte battenti. L'apertura dell'anta è sia verso l'interno che verso l'esterno. Modello adatto per situazioni che necessitano della massima apertura possibile.

Corner shower enclosure configuration consisting of two hinged doors. The doors open both inward and outward. A model suitable for situations requiring the maximum possible opening.

## CONFIGURAZIONE AD ANGOLO CORNER CONFIGURATION

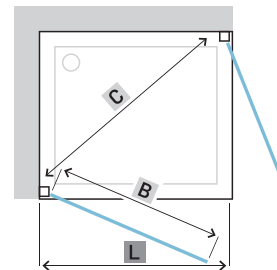

### ! CONFIGURAZIONI IN NICCHIA E A TRE LATI NICHE AND THREE-SIDED CONFIGURATIONS

Non è possibile realizzare configurazioni in nicchia.  
Non è possibile realizzare configurazioni a tre lati.  
It is not possible to create niche configurations.  
It is not possible to create three-sided configurations.

## ORIENTAMENTO E POSSIBILI COMBINAZIONI / ORIENTATION AND POSSIBLE CONFIGURATIONS

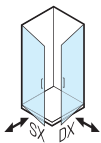

### PROFILI / PROFILES

STANDARD	
ULU	Brillantato Lucido Brilliant Polished
L91	Bianco Opaco Matte White
L96	Nero Opaco Matte Black

DOLCEVITA	
SNK	Nickel Spazzolato Nickel Brushed
AL4	Bronzo Spazzolato Brushed Bronze
AL5	Oro Rosa Lucido Polished Rose Gold
GLB	Oro Spazzolato Brushed Gold
GLP	Oro Lucido Polished Gold
GMB	Gun Metal Spazzolato Brushed Gun Metal

### VETRO / GLASS

STANDARD		
TR	Trasparente Transparent	
AS	Satinato Satin	
RF	Fascia H.100cm Band H.100cm	
ON DEMAND		
ST	Stampato Printed	TR +10%
TE	Extrachiario Extra Clear	TR +25%
TG	Trasparente Grigio Transparent Grey	TR +25%
GS	Satinato Grigio Satin Grey	TR +25%
SY	Specchio Mirror <sup>4</sup>	TR +50%

## PORTA / DOOR

L [cm]	COD.	L NOM. [cm]	B [cm]	C [cm]	[dm <sup>3</sup> ]	[kg]	[n°]	V	ULU	L96	L91	DOLCEVITA
67,8-69,8	B3900	66-68	61,6	85	102	24	1	TR	515,00			670,00
								AS-RF	645,00		840,00	
69,8-71,8	B3901	68-70	63,6	88	106	24	1	TR	520,00			675,00
								AS-RF	650,00		845,00	
71,8-73,8	B3902	70-72	65,6	91	108	24	1	TR	525,00			685,00
								AS-RF	655,00		855,00	
73,8-75,8	B3903	72-74	67,6	93	112	24	1	TR	530,00			690,00
								AS-RF	665,00		865,00	
75,8-77,8	B3904	74-76	69,6	96	114	25	1	TR	535,00			695,00
								AS-RF	670,00		870,00	
77,8-79,8	B3905	76-78	71,6	99	117	26	1	TR	540,00			700,00
								AS-RF	675,00		875,00	
79,8-81,8	B3906	78-80	73,6	102	118	28	1	TR	550,00			715,00
								AS-RF	690,00		895,00	
81,8-83,8	B3907	80-82	75,6	105	121	29	1	TR	555,00			720,00
								AS-RF	695,00		900,00	
83,8-85,8	B3908	82-84	77,6	108	124	30	1	TR	560,00			730,00
								AS-RF	700,00		915,00	
85,8-87,8	B3910	84-86	79,6	110	144	31	1	TR	565,00			735,00
								AS-RF	705,00		920,00	
87,8-89,8	B3911	86-88	81,6	113	146	32	1	TR	570,00			740,00
								AS-RF	715,00		925,00	
97,8-99,8	B3912	96-98	91,6	127	175	38	1	TR	595,00			775,00
								AS-RF	745,00		970,00	

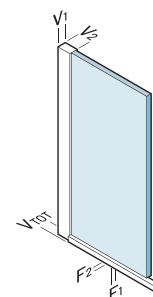

L	
V <sub>1</sub>	35mm
V <sub>2</sub>	38mm
V <sub>TOT</sub>	39mm
F <sub>1</sub>	9mm
F <sub>2</sub>	9mm

**I** I valori della tabella prezzi si riferiscono ad un singolo lato: sommare l'importo dei due codici della misura desiderata per ottenere il prezzo totale di una doccia ad angolo quadrata o rettangolare. Apertura (C) determinata con due lati della stessa misura. Specificare il verso di apertura della parete doccia (/SX o /DX)  
 The prices in the table refer to a single side: add the amounts of the two codes for the desired size to get the total price of a square or rectangular corner shower. Opening (C) is determined by two sides of the same size. Specify the opening direction of the shower enclosure (/SX or /DX).

SU MISURA/CUSTOM	PORTA DOOR	[€]
▲▼ Altezza/Height <sup>1</sup>	135-217cm	+20%
◀▶ Larghezza/Width <sup>2</sup>	21-100cm	+20%
◆ Altezza/Height ◆ Larghezza/Width <sup>2</sup>	135-217cm 21-100cm	+20%
Altre forme Other shapes <sup>2</sup>		+30%

OPTIONAL	COD.	[€]
Maniglia/Handle 16cm <sup>3</sup>	H00	40,00
Maniglia/Handle 32cm <sup>3</sup>	L00	50,00
Maniglia/Handle 32cm <sup>3</sup>	N00	50,00
 StarClean	Porta/Door (1 lato / 1 side)	50,00

<sup>1</sup> Dal prezzo della misura di riferimento / From the price of selected size

<sup>2</sup> Dal prezzo della misura superiore / From the price of the larger size

<sup>3</sup> Da richiedere al momento dell'ordine / To be requested at the time of order

<sup>4</sup> Contattare l'ufficio clienti per informazioni / Contact the customer service office for information

DISPONIBILITA' A MAGAZZINO / STOCK AVAILABILITY

1/2 Settimane/Weeks

2/3 Settimane/Weeks

3/4 Settimane/Weeks

+1 StarClean Optional

# POLARIS

PORTA BATTENTE + PARETE FISSA  
HINGED DOOR + FIXED PANEL



Per istruzioni di montaggio  
e ricambi inquadra il codice QR  
For assembly instructions  
and spare parts, scan the QR code



H. 195cm  
SP. 6mm

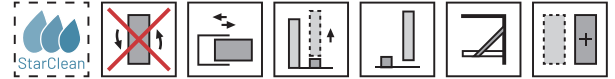

Parete doccia in configurazione ad angolo formata da porta battente più parete fissa. L'apertura dell'anta è sia verso l'interno che verso l'esterno. Modello adatto per situazioni che necessitano di un'ampia apertura in un unico lato del prodotto.

Corner shower enclosure configuration consisting of a hinged door and a fixed panel. The door opens both inward and outward. A model suitable for situations requiring a wide opening on one side of the product.

## CONFIGURAZIONE AD ANGOLO CORNER CONFIGURATION

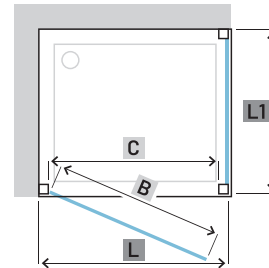

### CONFIGURAZIONI IN NICCHIA E A TRE LATI NICHE AND THREE-SIDED CONFIGURATIONS

Non è possibile realizzare configurazioni in nicchia.  
Non è possibile realizzare configurazioni a tre lati.  
It is not possible to create niche configurations.  
It is not possible to create three-sided configurations.

## ORIENTAMENTO E POSSIBILI COMBINAZIONI / ORIENTATION AND POSSIBLE CONFIGURATIONS

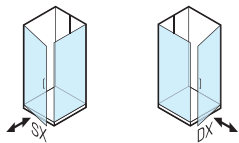

### PROFILI / PROFILES

STANDARD	
ULU	Brillantato Lucido Brilliant Polished
L91	Bianco Opaco Matte White
L96	Nero Opaco Matte Black

DOLCEVITA	
SNK	Nickel Spazzolato Nickel Brushed
AL4	Bronzo Spazzolato Brushed Bronze
AL5	Oro Rosa Lucido Polished Rose Gold
GLB	Oro Spazzolato Brushed Gold
GLP	Oro Lucido Polished Gold
GMB	Gun Metal Spazzolato Brushed Gun Metal

### VETRO / GLASS

STANDARD		
TR	Trasparente Transparent	
AS	Satinato Satin	
RF	Fascia H.100cm Band H.100cm	
ON DEMAND		
ST	Stampato Printed	TR +10%
TE	Extrachiario Extra Clear	TR +25%
TG	Trasparente Grigio Transparent Grey	TR +25%
GS	Satinato Grigio Satin Grey	TR +25%
SY	Specchio Mirror <sup>4</sup>	TR +50%

## PORTA / DOOR

L [cm]	COD.	L NOM. [cm]	B [cm]	C [cm]	[dm <sup>3</sup> ]	[kg]	[n°]	V	ULU	L96	L91	DOLCEVITA
67,3-69,3	<b>B3900</b>	66-68	61,6	60,1	102	24	1	TR	515,00	645,00		670,00
								AS-RF		520,00		840,00
69,3-71,3	<b>B3901</b>	68-70	63,6	62,1	106	24	1	TR	520,00	650,00		675,00
								AS-RF		525,00		845,00
71,3-73,3	<b>B3902</b>	70-72	65,6	64,1	108	24	1	TR	525,00	655,00		685,00
								AS-RF		530,00		855,00
73,3-75,3	<b>B3903</b>	72-74	67,6	66,1	112	24	1	TR	530,00	665,00		690,00
								AS-RF		535,00		865,00
75,3-77,3	<b>B3904</b>	74-76	69,6	68,1	114	25	1	TR	535,00	670,00		695,00
								AS-RF		540,00		870,00
77,3-79,3	<b>B3905</b>	76-78	71,6	70,1	117	26	1	TR	540,00	675,00		700,00
								AS-RF		550,00		875,00
79,3-81,3	<b>B3906</b>	78-80	73,6	72,1	118	28	1	TR	550,00	690,00		715,00
								AS-RF		555,00		895,00
81,3-83,3	<b>B3907</b>	80-82	75,6	74,1	121	29	1	TR	555,00	695,00		720,00
								AS-RF		560,00		900,00
83,3-85,3	<b>B3908</b>	82-84	77,6	76,1	124	30	1	TR	560,00	700,00		730,00
								AS-RF		565,00		915,00
85,3-87,3	<b>B3910</b>	84-86	79,6	78,1	144	31	1	TR	565,00	705,00		735,00
								AS-RF		570,00		920,00
87,3-89,3	<b>B3911</b>	86-88	81,6	80,1	146	32	1	TR	570,00	715,00		740,00
								AS-RF		575,00		925,00
97,3-99,3	<b>B3912</b>	96-98	91,6	90,1	175	38	1	TR	595,00	745,00		775,00
								AS-RF				970,00

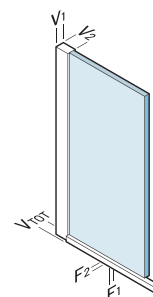

L	
V <sub>1</sub>	35mm
V <sub>2</sub>	38mm
V <sub>TOT</sub>	39mm
F <sub>1</sub>	9mm
F <sub>2</sub>	9mm

## PARETE FISSA / FIXED PANEL

L1 [cm]	COD.	L1 NOM. [cm]	B [cm]	C [cm]	[dm <sup>3</sup> ]	[kg]	[n°]	V	ULU	L96	L91	DOLCEVITA
65,8-68,3	<b>B3850</b>	64-66,5	-	-	99	29	1	TR	490,00	615,00		635,00
								AS-RF		495,00		795,00
68,3-70,8	<b>B3851</b>	66,5-69	-	-	101	29	1	TR	495,00	500,00		645,00
								AS-RF		500,00		805,00
70,8-73,3	<b>B3852</b>	69-71,5	-	-	102	29	1	TR	500,00	505,00		650,00
								AS-RF		505,00		815,00
73,3-75,8	<b>B3853</b>	71,5-74	-	-	112	29	1	TR	500,00	515,00		650,00
								AS-RF		515,00		815,00
75,8-78,3	<b>B3854</b>	74-76,5	-	-	115	30	1	TR	505,00	520,00		655,00
								AS-RF		520,00		820,00
78,3-80,8	<b>B3855</b>	76,5-79	-	-	117	31	1	TR	505,00	510,00		655,00
								AS-RF		510,00		820,00
80,8-83,3	<b>B3856</b>	79-81,5	-	-	120	34	1	TR	510,00	515,00		665,00
								AS-RF		515,00		830,00
83,3-85,8	<b>B3857</b>	81,5-84	-	-	137	35	1	TR	515,00	520,00		670,00
								AS-RF		520,00		830,00
85,8-88,3	<b>B3858</b>	84-86,5	-	-	140	35	1	TR	520,00	530,00		675,00
								AS-RF		530,00		845,00
83,3-90,8	<b>B3860</b>	86,5-89	-	-	143	35	1	TR	530,00	530,00		690,00
								AS-RF		530,00		865,00
90,8-93,3	<b>B3861</b>	89-91,5	-	-	144	36	1	TR	530,00	530,00		690,00
								AS-RF		530,00		865,00
98,3-100,8	<b>B3862</b>	96,5-99	-	-	156	37	1	TR	550,00	570,00		715,00
								AS-RF		570,00		885,00
100,8-103,3	<b>B3863</b>	99-101,5	-	-	160	38	1	TR	570,00	585,00		740,00
								AS-RF		585,00		905,00
108,3-110,8	<b>B3864</b>	106,5-109	-	-	162	39	1	TR	575,00	605,00		760,00
								AS-RF		605,00		925,00
110,8-113,3	<b>B3865</b>	109-111,5	-	-	165	40	1	TR	605,00	625,00		785,00
								AS-RF		625,00		950,00
118,3-120,8	<b>B3866</b>	116,5-119	-	-	168	41	1	TR	625,00	645,00		815,00
								AS-RF		645,00		980,00
120,8-123,3	<b>B3867</b>	119-121,5	-	-	170	42	1	TR	645,00	665,00		840,00
								AS-RF		665,00		1.020,00

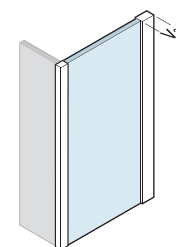

L1	
V <sub>2</sub>	42mm

H. 195cm  
SP. 6mm

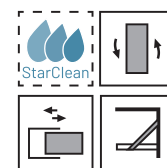

SU MISURA/CUSTOM	PORTA DOOR	[€]	PARETE FISSA FIXED PANEL	[€]
▲▼ Altezza/Height <sup>1</sup>	135-217cm	+20%	50-217cm	+20%
◀▶ Larghezza/Width <sup>2</sup>	21-100cm	+20%	15-160cm	+20%
◆ Altezza/Height Larghezza/Width <sup>2</sup>	135-217cm 21-100cm	+20%	50-217cm 15-160cm	+20%
Altre forme Other shapes <sup>2</sup>		+30%		+30%

OPTIONAL	COD.	[€]
Maniglia/Handle 16cm <sup>3</sup>	<b>H00</b>	40,00
Maniglia/Handle 32cm <sup>3</sup>	<b>L00</b>	50,00
Maniglia/Handle 32cm <sup>3</sup>	<b>N00</b>	50,00
Kit di sostegno Support kit <sup>3</sup>	<b>KT3920</b>	135,00
	(L.140cm)	180,00
	Porta/Door	50,00
	Parete Fissa/Fixed Panel	50,00

<sup>1</sup> Dal prezzo della misura di riferimento / From the price of selected size

<sup>2</sup> Dal prezzo della misura superiore / From the price of the larger size

<sup>3</sup> Da richiedere al momento dell'ordine / To be requested at the time of order

<sup>4</sup> Contattare l'ufficio clienti per informazioni / Contact the customer service office for information

### DISPONIBILITA' A MAGAZZINO / STOCK AVAILABILITY

1/2 Settimane/Weeks	2/3 Settimane/Weeks	3/4 Settimane/Weeks
+1 StarClean Optional		

# POLARIS

PORTA BATTENTE CON FISSO IN LINEA  
HINGED DOOR WITH INLINE FIXED PANEL



Per istruzioni di montaggio  
e ricambi inquadra il codice QR  
For assembly instructions  
and spare parts, scan the QR code



**H. 195cm**  
**SP. 6mm**

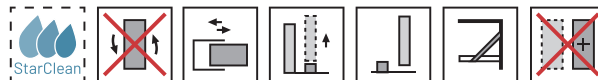

Parete doccia con apertura a porta battente con parete fissa in linea. L'apertura dell'anta è sia verso l'interno che verso l'esterno. Modello ad alto impatto estetico e disponibile in dimensioni maggiori rispetto ad una tradizionale porta.

Shower enclosure with a hinged door with a fixed inline panel. The door opens both inward and outward. A model with high aesthetic impact and available in larger sizes compared to a traditional door.

## CONFIGURAZIONE IN NICCHIA NICHE CONFIGURATION

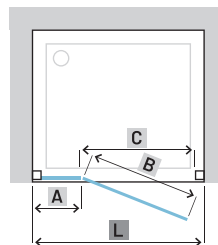

## CONFIGURAZIONI IN ANGOLO E A TRE LATI CORNER AND THREE-SIDED CONFIGURATIONS

Non è possibile realizzare configurazioni in angolo.  
Non è possibile realizzare configurazioni a tre lati.  
It is not possible to create corner configurations.  
It is not possible to create three-sided configurations.

## ORIENTAMENTO E POSSIBILI COMBINAZIONI / ORIENTATION AND POSSIBLE CONFIGURATIONS

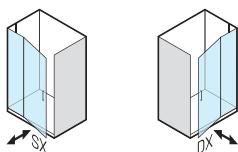

### PROFILI / PROFILES

STANDARD	
ULU	Brillantato Lucido Brilliant Polished
L91	Bianco Opaco Matte White
L96	Nero Opaco Matte Black

DOLCEVITA	
SNK	Nickel Spazzolato Nickel Brushed
AL4	Bronzo Spazzolato Brushed Bronze
AL5	Oro Rosa Lucido Polished Rose Gold
GLB	Oro Spazzolato Brushed Gold
GLP	Oro Lucido Polished Gold
GMB	Gun Metal Spazzolato Brushed Gun Metal

### VETRO / GLASS

STANDARD		
TR	Trasparente Transparent	
AS	Satinato Satin	
RF	Fascia H.100cm Band H.100cm	
ON DEMAND		
ST	Stampato Printed	TR +10%
TE	Extrachiaro Extra Clear	TR +25%
TG	Trasparente Grigio Transparent Grey	TR +25%
GS	Satinato Grigio Satin Grey	TR +25%
SY	Specchio Mirror <sup>4</sup>	TR +50%

**PORTA / DOOR**

L [cm]	COD.	A [cm]	B [cm]	C [cm]	[dm <sup>3</sup> ]	[kg]	[n°]	V	ULU	L96	L91	DOLCEVITA
65,5-69	<b>B3831</b>	22,1	41,1	40	133	26	1	TR	700,00			910,00
								AS-RF	875,00			1.140,00
69-72,5	<b>B3832</b>	23,1	43,6	42	136	28	1	TR	700,00			910,00
								AS-RF	875,00			1.140,00
72,5-76	<b>B3833</b>	23,6	46,6	45	139	28	1	TR	705,00			915,00
								AS-RF	880,00			1.145,00
76-79,5	<b>B3834</b>	24,6	49,1	48	142	30	1	TR	710,00			925,00
								AS-RF	890,00			1.155,00
79,5-83	<b>B3835</b>	24,6	52,6	51	145	32	1	TR	715,00			930,00
								AS-RF	895,00			1.165,00
83-86,5	<b>B3836</b>	25,5	55,1	54	148	33	1	TR	720,00			935,00
								AS-RF	900,00			1.170,00
86,5-90	<b>B3837</b>	25,5	58,6	57	150	35	1	TR	730,00			950,00
								AS-RF	915,00			1.190,00
90-93,5	<b>B3838</b>	29,1	58,6	57	152	36	1	TR	740,00			960,00
								AS-RF	925,00			1.200,00
93,5-97	<b>B3840</b>	32,6	58,6	57	157	36	1	TR	745,00			970,00
								AS-RF	930,00			1.215,00
97-100,5	<b>B3841</b>	31,2	63,3	62	160	38	1	TR	755,00			980,00
								AS-RF	945,00			1.225,00
100,5-104	<b>B3842</b>	34,7	63,3	62	163	38	1	TR	760,00			990,00
								AS-RF	950,00			1.240,00
104-107,5	<b>B3843</b>	36,4	65,3	64	166	38	1	TR	770,00			1.000,00
								AS-RF	965,00			1.250,00
107,5-111	<b>B3844</b>	35,8	69,3	68	175	39	1	TR	775,00			1.010,00
								AS-RF	970,00			1.265,00
111-114,5	<b>B3845</b>	39,3	69,3	68	180	41	1	TR	780,00			1.015,00
								AS-RF	975,00			1.270,00
114,5-118	<b>B3846</b>	40,8	71,3	70	193	41	1	TR	785,00			1.020,00
								AS-RF	980,00			1.275,00
118-121,5	<b>B3847</b>	42,3	73,3	72	195	42	1	TR	790,00			1.025,00
								AS-RF	990,00			1.280,00

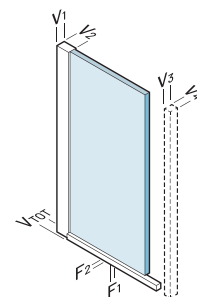

L	
V <sub>1</sub>	45mm
V <sub>2</sub>	42mm
V <sub>3</sub>	24mm
V <sub>4</sub>	23mm
V <sub>TOT</sub>	52mm
F <sub>1</sub>	9mm
F <sub>2</sub>	9mm

SU MISURA/CUSTOM	PORTA DOOR	[€]
▲▼ Altezza/Height <sup>1</sup>	150-217cm	+20%
◄► Larghezza/Width <sup>2</sup>	60-180cm	+20%
◆ Altezza/Height Larghezza/Width <sup>2</sup>	150-217cm 60-180cm	+20%
Altre forme Other shapes <sup>2</sup>		+30%

OPTIONAL	COD.	[€]
Maniglia/Handle 16cm <sup>3</sup>	<b>H00</b>	40,00
Maniglia/Handle 32cm <sup>3</sup>	<b>L00</b>	50,00
Maniglia/Handle 32cm <sup>3</sup>	<b>N00</b>	50,00
 StarClean	Porta/Door (1 lato / 1 side)	50,00

<sup>1</sup> Dal prezzo della misura di riferimento / From the price of selected size

<sup>2</sup> Dal prezzo della misura superiore / From the price of the larger size

<sup>3</sup> Da richiedere al momento dell'ordine / To be requested at the time of order

<sup>4</sup> Contattare l'ufficio clienti per informazioni / Contact the customer service office for information

DISPONIBILITA' A MAGAZZINO / STOCK AVAILABILITY

1/2 Settimane/Weeks

2/3 Settimane/Weeks

3/4 Settimane/Weeks

+1 StarClean Optional

# POLARIS

PORTA BATTENTE CON FISSO IN LINEA + PORTA BATTENTE CON FISSO IN LINEA  
HINGED DOOR WITH INLINE FIXED PANEL + HINGED DOOR WITH INLINE FIXED PANEL



Per istruzioni di montaggio  
e ricambi inquadra il codice QR  
For assembly instructions  
and spare parts, scan the QR code



**H. 195cm**  
**SP. 6mm**

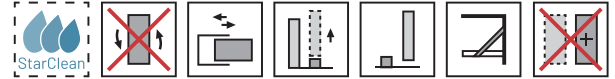

Parete doccia in configurazione ad angolo formata da due porte battenti con parete fissa in linea. L'apertura dell'anta è sia verso l'interno che verso l'esterno. Modello ad alto impatto estetico e disponibile in dimensioni maggiori rispetto ad una tradizionale porta.

Corner shower enclosure configuration consisting of two hinged doors with an inline fixed panel. The door opens both inward and outward. A model with a high aesthetic impact, available in larger sizes compared to a traditional door.

## CONFIGURAZIONE AD ANGOLO CORNER CONFIGURATION

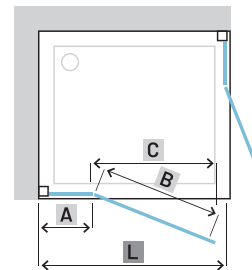

### ! CONFIGURAZIONI IN NICCHIA E A TRE LATI NICHE AND THREE-SIDED CONFIGURATIONS

Non è possibile realizzare configurazioni in nicchia.  
Non è possibile realizzare configurazioni a tre lati.  
It is not possible to create niche configurations.  
It is not possible to create three-sided configurations.

## ORIENTAMENTO E POSSIBILI COMBINAZIONI / ORIENTATION AND POSSIBLE CONFIGURATIONS

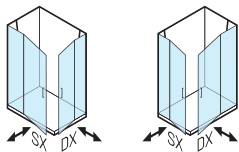

### PROFILI / PROFILES

STANDARD	
ULU	Brillantato Lucido Brilliant Polished
L91	Bianco Opaco Matte White
L96	Nero Opaco Matte Black

DOLCEVITA	
SNK	Nickel Spazzolato Nickel Brushed
AL4	Bronzo Spazzolato Brushed Bronze
AL5	Oro Rosa Lucido Polished Rose Gold
GLB	Oro Spazzolato Brushed Gold
GLP	Oro Lucido Polished Gold
GMB	Gun Metal Spazzolato Brushed Gun Metal

### VETRO / GLASS

STANDARD		
TR	Trasparente Transparent	
AS	Satinato Satin	
RF	Fascia H.100cm Band H.100cm	
ON DEMAND		
ST	Stampato Printed	TR +10%
TE	Extrachiario Extra Clear	TR +25%
TG	Trasparente Grigio Transparent Grey	TR +25%
GS	Satinato Grigio Satin Grey	TR +25%
SY	Specchio Mirror <sup>4</sup>	TR +50%

## PORTA / DOOR

L [cm]	COD.	L NOM. [cm]	A [cm]	B [cm]	C [cm]	[dm <sup>3</sup> ]	[kg]	[n°]	V	ULU	L96	L91	DOLCEVITA
66,8-69,3	<b>B3800</b>	65-67,5	23,1	41,4	57	133	27	1	TR	665,00			865,00
									AS-RF	830,00			1.080,00
69,3-71,8	<b>B3801</b>	67,5-70	23,1	43,9	60	136	28	1	TR	670,00			870,00
									AS-RF	840,00			1.090,00
72,3-74,8	<b>B3802</b>	70,5-73	23,1	46,9	65	136	28	1	TR	670,00			870,00
									AS-RF	840,00			1.090,00
74,8-77,3	<b>B3803</b>	73-75,5	25,5	46,9	65	141	29	1	TR	675,00			880,00
									AS-RF	845,00			1.100,00
78,3-80,8	<b>B3804</b>	76,5-79	26,6	49,4	68	143	30	1	TR	680,00			885,00
									AS-RF	850,00			1.105,00
80,8-83,3	<b>B3805</b>	79-81,5	25,5	52,9	73	146	31	1	TR	680,00			885,00
									AS-RF	850,00			1.105,00
83,8-86,3	<b>B3806</b>	82-84,5	28,6	52,9	73	148	31	1	TR	685,00			890,00
									AS-RF	855,00			1.115,00
86,8-89,3	<b>B3807</b>	85-87,5	25,5	58,9	82	156	32	1	TR	690,00			895,00
									AS-RF	865,00			1.120,00
89,3-91,8	<b>B3808</b>	87,5-90	28,1	58,9	82	165	33	1	TR	695,00			905,00
									AS-RF	870,00			1.130,00
96,8-99,3	<b>B3810</b>	95-97,5	30,8	63,6	88	171	35	1	TR	705,00			915,00
									AS-RF	880,00			1.145,00
99,3-101,8	<b>B3811</b>	97,5-100	33,5	63,6	88	175	36	1	TR	705,00			915,00
									AS-RF	880,00			1.145,00
106,8-109,3	<b>B3812</b>	105-107,5	34,7	69,6	97	185	39	1	TR	720,00			935,00
									AS-RF	900,00			1.170,00
116,8-119,3	<b>B3813</b>	115-117,5	45,1	69,6	97	195	42	1	TR	735,00			955,00
									AS-RF	920,00			1.195,00

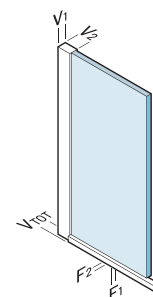

L	
V <sub>1</sub>	45mm
V <sub>2</sub>	42mm
V <sub>TOT</sub>	52mm
F <sub>1</sub>	9mm
F <sub>2</sub>	9mm

**!** I valori della tabella prezzi si riferiscono ad un singolo lato: sommare l'importo dei due codici della misura desiderata per ottenere il prezzo totale di una doccia ad angolo quadrata o rettangolare. Apertura (C) determinata con due lati della stessa misura. Specificare il verso di apertura della parete doccia (/SX o /DX).  
 The prices in the table refer to a single side: add the amounts of the two codes for the desired size to get the total price of a square or rectangular corner shower. Opening (C) is determined by two sides of the same size. Specify the opening direction of the shower enclosure (/SX or /DX).

SU MISURA/CUSTOM	PORTA DOOR	[€]
▲▼ Altezza/Height <sup>1</sup>	150-217cm	+20%
◀▶ Larghezza/Width <sup>2</sup>	60-180cm	+20%
◆ Altezza/Height ◆ Larghezza/Width <sup>2</sup>	150-217cm 60-180cm	+20%
Altre forme Other shapes <sup>2</sup>		+30%

OPTIONAL	COD.	[€]
Maniglia/Handle 16cm <sup>3</sup>	<b>H00</b>	40,00
Maniglia/Handle 32cm <sup>3</sup>	<b>L00</b>	50,00
Maniglia/Handle 32cm <sup>3</sup>	<b>N00</b>	50,00
 StarClean	Porta/Door (1 lato / 1 side)	50,00

<sup>1</sup> Dal prezzo della misura di riferimento / From the price of selected size

<sup>2</sup> Dal prezzo della misura superiore / From the price of the larger size

<sup>3</sup> Da richiedere al momento dell'ordine / To be requested at the time of order

<sup>4</sup> Contattare l'ufficio clienti per informazioni / Contact the customer service office for information

DISPONIBILITA' A MAGAZZINO / STOCK AVAILABILITY

1/2 Settimane/Weeks

2/3 Settimane/Weeks

3/4 Settimane/Weeks

+1 StarClean Optional

# POLARIS

PORTA BATTENTE CON FISSO IN LINEA + PARETE FISSA  
HINGED DOOR WITH INLINE FIXED PANEL + FIXED PANEL



Per istruzioni di montaggio  
e ricambi inquadra il codice QR  
For assembly instructions  
and spare parts, scan the QR code



H. 195cm  
SP. 6mm

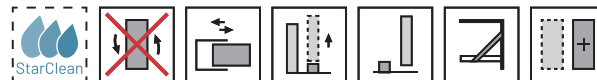

Parete doccia in configurazione ad angolo formata da porta battente con parete fissa in linea più parete fissa. L'apertura dell'anta è sia verso l'interno che verso l'esterno. Modello ad alto impatto estetico e disponibile in dimensioni maggiori rispetto ad una tradizionale porta.

Corner shower enclosure configuration consisting of a hinged door with an inline fixed panel and an additional fixed panel. The door opens both inward and outward. A model with a high aesthetic impact, available in larger sizes compared to a traditional door.

## CONFIGURAZIONE AD ANGOLO CORNER CONFIGURATION

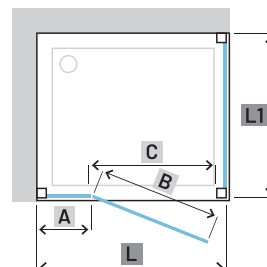

## CONFIGURAZIONI IN NICCHIA E A TRE LATI NICHE AND THREE-SIDED CONFIGURATIONS

Non è possibile realizzare configurazioni in nicchia.  
Per configurazioni a tre lati obbligatorio acquistare KT3800  
It is not possible to create niche configurations.  
For three-sided configurations, it is mandatory to purchase KT3800.

## ORIENTAMENTO E POSSIBILI COMBINAZIONI / ORIENTATION AND POSSIBLE CONFIGURATIONS

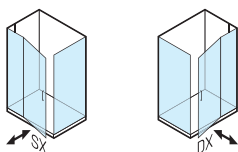

### PROFILI / PROFILES

STANDARD	
ULU	Brillantato Lucido Brilliant Polished
L91	Bianco Opaco Matte White
L96	Nero Opaco Matte Black

DOLCEVITA	
SNK	Nickel Spazzolato Nickel Brushed
AL4	Bronzo Spazzolato Brushed Bronze
AL5	Oro Rosa Lucido Polished Rose Gold
GLB	Oro Spazzolato Brushed Gold
GLP	Oro Lucido Polished Gold
GMB	Gun Metal Spazzolato Brushed Gun Metal

### VETRO / GLASS

STANDARD		
TR	Trasparente Transparent	
AS	Satinato Satin	
RF	Fascia H.100cm Band H.100cm	
ON DEMAND		
ST	Stampato Printed	TR +10%
TE	Extrachiario Extra Clear	TR +25%
TG	Trasparente Grigio Transparent Grey	TR +25%
GS	Satinato Grigio Satin Grey	TR +25%
SY	Specchio Mirror <sup>4</sup>	TR +50%

**PORTA / DOOR**

L [cm]	COD.	L NOM. [cm]	A [cm]	B [cm]	C [cm]	[dm <sup>3</sup> ]	[kg]	[n°]	V	ULU	L96	L91	DOLCEVITA
66,3-68,8	<b>B3800</b>	65-67,5	23,1	41,4	40	133	27	1	TR	665,00			865,00
									AS-RF	830,00			1.080,00
68,8-71,3	<b>B3801</b>	67,5-70	23,1	43,9	42,5	136	28	1	TR	670,00			870,00
									AS-RF	840,00			1.090,00
71,8-74,3	<b>B3802</b>	70,5-73	23,1	46,9	45,5	136	28	1	TR	670,00			870,00
									AS-RF	840,00			1.090,00
74,3-76,8	<b>B3803</b>	73-75,5	25,5	46,9	45,5	141	29	1	TR	675,00			880,00
									AS-RF	845,00			1.100,00
77,8-80,3	<b>B3804</b>	76,5-79	26,6	49,4	48	143	30	1	TR	680,00			885,00
									AS-RF	850,00			1.105,00
80,3-82,8	<b>B3805</b>	79-81,5	25,5	52,9	51,5	146	31	1	TR	680,00			885,00
									AS-RF	850,00			1.105,00
83,3-85,8	<b>B3806</b>	82-84,5	28,6	52,9	51,5	148	31	1	TR	685,00			890,00
									AS-RF	855,00			1.115,00
86,3-88,8	<b>B3807</b>	85-87,5	25,5	58,9	57,5	156	32	1	TR	690,00			895,00
									AS-RF	865,00			1.120,00
88,8-91,3	<b>B3808</b>	87,5-90	28,1	58,9	57,5	165	33	1	TR	695,00			905,00
									AS-RF	870,00			1.130,00
96,3-98,8	<b>B3810</b>	95-97,5	30,8	63,6	62	171	35	1	TR	705,00			915,00
									AS-RF	880,00			1.145,00
98,8-101,3	<b>B3811</b>	97,5-100	33,5	63,6	62	175	36	1	TR	705,00			915,00
									AS-RF	880,00			1.145,00
106,3-108,8	<b>B3812</b>	105-107,5	34,7	69,6	68	185	39	1	TR	720,00			935,00
									AS-RF	900,00			1.170,00
116,3-118,8	<b>B3813</b>	115-117,5	45,1	69,6	68	195	42	1	TR	735,00			955,00
									AS-RF	920,00			1.195,00

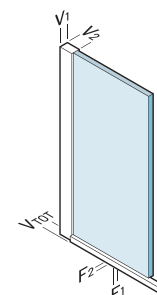

L	V1	V2	V <sub>TOT</sub>	F1	F2
	45mm	42mm	52mm	9mm	9mm

**PARETE FISSA / FIXED PANEL**

L1 [cm]	COD.	L1 NOM. [cm]	A [cm]	B [cm]	C [cm]	[dm <sup>3</sup> ]	[kg]	[n°]	V	ULU	L96	L91	DOLCEVITA
65,8-68,3	<b>B3850</b>	64-66,5	-	-	-	99	29	1	TR	490,00			635,00
									AS-RF	615,00			795,00
68,3-70,8	<b>B3851</b>	66,5-69	-	-	-	101	29	1	TR	495,00			645,00
									AS-RF	620,00			805,00
70,8-73,3	<b>B3852</b>	69-71,5	-	-	-	102	29	1	TR	500,00			650,00
									AS-RF	625,00			815,00
73,3-75,8	<b>B3853</b>	71,5-74	-	-	-	112	29	1	TR	500,00			650,00
									AS-RF	625,00			815,00
75,8-78,3	<b>B3854</b>	74-76,5	-	-	-	115	30	1	TR	505,00			655,00
									AS-RF	630,00			820,00
78,3-80,8	<b>B3855</b>	76,5-79	-	-	-	117	31	1	TR	505,00			655,00
									AS-RF	630,00			820,00
80,8-83,3	<b>B3856</b>	79-81,5	-	-	-	120	34	1	TR	510,00			665,00
									AS-RF	640,00			830,00
83,3-85,8	<b>B3857</b>	81,5-84	-	-	-	137	35	1	TR	515,00			670,00
									AS-RF	645,00			840,00
85,8-88,3	<b>B3858</b>	84-86,5	-	-	-	140	35	1	TR	520,00			675,00
									AS-RF	650,00			845,00
83,3-90,8	<b>B3860</b>	86,5-89	-	-	-	143	35	1	TR	530,00			690,00
									AS-RF	665,00			865,00
90,8-93,3	<b>B3861</b>	89-91,5	-	-	-	144	36	1	TR	530,00			690,00
									AS-RF	665,00			865,00
98,3-100,8	<b>B3862</b>	96,5-99	-	-	-	156	37	1	TR	550,00			715,00
									AS-RF	690,00			895,00
100,8-103,3	<b>B3863</b>	99-101,5	-	-	-	160	38	1	TR	570,00			740,00
									AS-RF	715,00			925,00
108,3-110,8	<b>B3864</b>	106,5-109	-	-	-	162	39	1	TR	585,00			760,00
									AS-RF	730,00			950,00
110,8-113,3	<b>B3865</b>	109-111,5	-	-	-	165	40	1	TR	605,00			785,00
									AS-RF	755,00			980,00
118,3-120,8	<b>B3866</b>	116,5-119	-	-	-	168	41	1	TR	625,00			815,00
									AS-RF	780,00			1.020,00
120,8-123,3	<b>B3867</b>	119-121,5	-	-	-	170	42	1	TR	645,00			840,00
									AS-RF	805,00			1.050,00

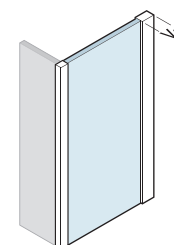

L1	L2
	42mm

H. 195cm  
SP. 6mm

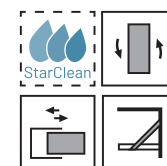

SU MISURA/CUSTOM	PORTA DOOR	[€]	PARETE FISSA FIXED PANEL	[€]
↕ Altezza/Height <sup>1</sup>	150-217cm	+20%	50-217cm	+20%
↔ Larghezza/Width <sup>2</sup>	60-180cm	+20%	15-160cm	+20%
↕ Altezza/Height	150-217cm	+20%	50-217cm	+20%
↔ Larghezza/Width <sup>2</sup>	60-180cm	+20%	15-160cm	+20%
Altre forme Other shapes <sup>2</sup>		+30%		+30%

OPTIONAL	COD.	[€]
Maniglia/Handle 16cm <sup>3</sup>	<b>H00</b>	40,00
Maniglia/Handle 32cm <sup>3</sup>	<b>L00</b>	ULU-L91-L96 50,00
Maniglia/Handle 32cm <sup>3</sup>	<b>N00</b>	DOLCEVITA 50,00
Kit di sostegno Support kit <sup>3</sup>	<b>KT3800</b>	ULU-L91-L96 150,00
	(L.200cm)	DOLCEVITA 195,00
StarClean	Porta/Door	50,00
	Parete Fissa/Fixed Panel	50,00

<sup>1</sup> Dal prezzo della misura di riferimento / From the price of selected size

<sup>2</sup> Dal prezzo della misura superiore / From the price of the larger size

<sup>3</sup> Da richiedere al momento dell'ordine / To be requested at the time of order

<sup>4</sup> Contattare l'ufficio clienti per informazioni / Contact the customer service office for information

**DISPONIBILITA' A MAGAZZINO / STOCK AVAILABILITY**

1/2 Settimane/Weeks	2/3 Settimane/Weeks	3/4 Settimane/Weeks
+1 StarClean Optional		

# POLARIS

PORTA BATTENTE SU FISSO IN LINEA  
HINGED DOOR ON FIXED INLINE



Per istruzioni di montaggio  
e ricambi inquadra il codice QR  
For assembly instructions  
and spare parts, scan the QR code



**H. 195cm**  
**SP. 6mm**

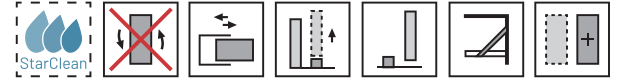

Parete doccia con apertura a porta battente su parete fissa in linea.  
L'apertura dell'anta è sia verso l'interno che verso l'esterno. Modello ad alto impatto estetico e disponibile in dimensioni maggiori rispetto ad una tradizionale porta.

Shower enclosure with a hinged door opening on an inline fixed panel.  
The door opens both inward and outward. A model with a high aesthetic impact, available in larger sizes compared to a traditional door.

## CONFIGURAZIONE IN NICCHIA NICHE CONFIGURATION

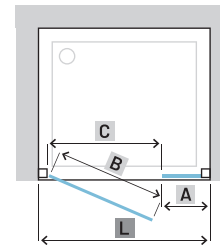

## CONFIGURAZIONI IN ANGOLO E A TRE LATI CORNER AND THREE-SIDED CONFIGURATIONS

Non è possibile realizzare configurazioni in angolo.  
Non è possibile realizzare configurazioni a tre lati.  
It is not possible to create corner configurations.  
It is not possible to create three-sided configurations.

## ORIENTAMENTO E POSSIBILI COMBINAZIONI / ORIENTATION AND POSSIBLE CONFIGURATIONS

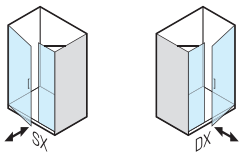

### PROFILI / PROFILES

STANDARD	
ULU	Brillantato Lucido Brilliant Polished
L91	Bianco Opaco Matte White
L96	Nero Opaco Matte Black

DOLCEVITA	
SNK	Nickel Spazzolato Nickel Brushed
AL4	Bronzo Spazzolato Brushed Bronze
AL5	Oro Rosa Lucido Polished Rose Gold
GLB	Oro Spazzolato Brushed Gold
GLP	Oro Lucido Polished Gold
GMB	Gun Metal Spazzolato Brushed Gun Metal

### VETRO / GLASS

STANDARD		
TR	Trasparente Transparent	
AS	Satinato Satin	
RF	Fascia H.100cm Band H.100cm	
ON DEMAND		
ST	Stampato Printed	TR +10%
TE	Extrachiario Extra Clear	TR +25%
TG	Trasparente Grigio Transparent Grey	TR +25%
GS	Satinato Grigio Satin Grey	TR +25%
SY	Specchio Mirror <sup>4</sup>	TR +50%

**PORTA / DOOR**

L [cm]	COD.	A [cm]	B [cm]	C [cm]	[dm <sup>3</sup> ]	[kg]	[n°]	V	ULU	L96	L91	DOLCEVITA
97-101	<b>B3980</b>	34,2	58,4	57	116	38	1	TR	815,00			1.060,00
								AS-RF	1.020,00			1.325,00
101-105	<b>B3981</b>	38,1	58,4	57	116	38	1	TR	830,00			1.080,00
								AS-RF	1.040,00			1.350,00
107-111	<b>B3982</b>	41,4	61,1	60	122	39	1	TR	850,00			1.105,00
								AS-RF	1.065,00			1.380,00
111-115	<b>B3983</b>	41,4	65,1	64	130	41	1	TR	870,00			1.130,00
								AS-RF	1.090,00			1.415,00
117-121	<b>B3984</b>	43,5	69,1	68	138	42	1	TR	870,00			1.130,00
								AS-RF	1.090,00			1.415,00
121-125	<b>B3985</b>	43,5	73,1	72	146	45	1	TR	885,00			1.150,00
								AS-RF	1.105,00			1.440,00
137-141	<b>B3986</b>	57,5	75,1	74	150	49	1	TR	925,00			1.205,00
								AS-RF	1.155,00			1.505,00
157-161	<b>B3987</b>	73,4	79,1	78	158	52	2	TR	965,00			1.255,00
								AS-RF	1.205,00			1.570,00
167-171	<b>B3988</b>	72,3	90,3	89	180	60	2	TR	990,00			1.285,00
								AS-RF	1.240,00			1.605,00
177-181	<b>B3990</b>	82,3	90,3	89	180	65	2	TR	1.020,00			1.325,00
								AS-RF	1.275,00			1.655,00

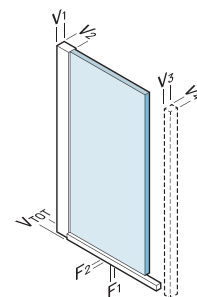

L	
V <sub>1</sub>	35mm
V <sub>2</sub>	38mm
V <sub>3</sub>	24mm
V <sub>4</sub>	23mm
V <sub>TOT</sub>	39mm
F <sub>1</sub>	9mm
F <sub>2</sub>	9mm

SU MISURA/CUSTOM	PORTA DOOR	[€]
▲▼ Altezza/Height <sup>1</sup>	150-217cm	+20%
◀▶ Larghezza/Width <sup>2</sup>	60-180cm	+20%
◆ Altezza/Height Larghezza/Width <sup>2</sup>	150-217cm 60-180cm	+20%
Altre forme Other shapes <sup>2</sup>		+30%

OPTIONAL	COD.	[€]
Maniglia/Handle 16cm <sup>3</sup>	<b>H00</b>	40,00
Maniglia/Handle 32cm <sup>3</sup>	<b>L00</b>	50,00
Maniglia/Handle 32cm <sup>3</sup>	<b>N00</b>	50,00
 StarClean	Porta/Door	50,00

<sup>1</sup> Dal prezzo della misura di riferimento / From the price of selected size

<sup>2</sup> Dal prezzo della misura superiore / From the price of the larger size

<sup>3</sup> Da richiedere al momento dell'ordine / To be requested at the time of order

<sup>4</sup> Contattare l'ufficio clienti per informazioni / Contact the customer service office for information

**DISPONIBILITA' A MAGAZZINO / STOCK AVAILABILITY**

1/2 Settimane/Weeks

2/3 Settimane/Weeks

3/4 Settimane/Weeks

+1 StarClean Optional

# POLARIS

PORTA BATTENTE SU FISSO IN LINEA + PARETE FISSA  
HINGED DOOR ON FIXED INLINE + FIXED PANEL



Per istruzioni di montaggio  
e ricambi inquadra il codice QR  
For assembly instructions  
and spare parts, scan the QR code



**H. 195cm**  
**SP. 6mm**

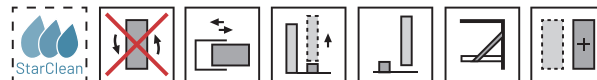

Parete doccia in configurazione ad angolo formata da porta battente su parete fissa in linea più parete fissa. L'apertura dell'anta è sia verso l'interno che verso l'esterno. Modello ad alto impatto estetico e disponibile in dimensioni maggiori rispetto ad una tradizionale porta.

Corner shower enclosure configuration consisting of a hinged door on an inline fixed panel and an additional fixed panel. The door opens both inward and outward. A model with a high aesthetic impact, available in larger sizes compared to a traditional door.

## CONFIGURAZIONE AD ANGOLO CORNER CONFIGURATION

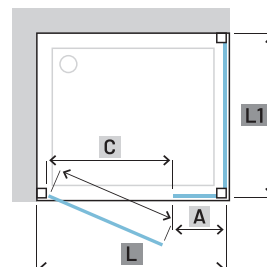

## CONFIGURAZIONI IN NICCHIA E A TRE LATI NICHE AND THREE-SIDED CONFIGURATIONS

Non è possibile realizzare configurazioni in nicchia.  
Non è possibile realizzare configurazioni a tre lati.  
It is not possible to create niche configurations.  
It is not possible to create three-sided configurations.

## ORIENTAMENTO E POSSIBILI COMBINAZIONI / ORIENTATION AND POSSIBLE CONFIGURATIONS

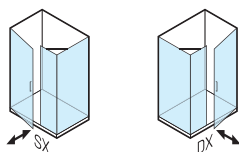

### PROFILI / PROFILES

STANDARD	
ULU	Brillantato Lucido Brilliant Polished
L91	Bianco Opaco Matte White
L96	Nero Opaco Matte Black

DOLCEVITA	
SNK	Nickel Spazzolato Nickel Brushed
AL4	Bronzo Spazzolato Brushed Bronze
AL5	Oro Rosa Lucido Polished Rose Gold
GLB	Oro Spazzolato Brushed Gold
GLP	Oro Lucido Polished Gold
GMB	Gun Metal Spazzolato Brushed Gun Metal

### VETRO / GLASS

STANDARD		
TR	Trasparente Transparent	
AS	Satinato Satin	
RF	Fascia H.100cm Band H.100cm	
ON DEMAND		
ST	Stampato Printed	TR +10%
TE	Extrachiario Extra Clear	TR +25%
TG	Trasparente Grigio Transparent Grey	TR +25%
GS	Satinato Grigio Satin Grey	TR +25%
SY	Specchio Mirror <sup>4</sup>	TR +50%

## PORTA / DOOR

L [cm]	COD.	L NOM. [cm]	A [cm]	B [cm]	C [cm]	[dm <sup>3</sup> ]	[kg]	[n°]	V	ULU	L96	L91	DOLCEVITA
98,3-102,3	<b>B3980</b>	97-101	34,2	58,4	57	116	38	1	TR AS-RF	815,00 1.020,00			1.060,00 1.325,00
102,3-106,3	<b>B3981</b>	101-105	38,1	58,4	57	116	38	1	TR AS-RF	830,00 1.040,00			1.080,00 1.350,00
108,3-112,3	<b>B3982</b>	107-111	41,4	61,1	60	122	39	1	TR AS-RF	850,00 1.065,00			1.105,00 1.380,00
112,3-116,3	<b>B3983</b>	111-115	41,4	65,1	64	130	41	1	TR AS-RF	870,00 1.090,00			1.130,00 1.415,00
118,3-122,3	<b>B3984</b>	117-121	43,5	69,1	68	138	42	1	TR AS-RF	870,00 1.090,00			1.130,00 1.415,00
122,3-126,3	<b>B3985</b>	121-125	43,5	73,1	72	146	45	1	TR AS-RF	885,00 1.105,00			1.150,00 1.440,00
138,3-142,3	<b>B3986</b>	137-141	57,5	75,1	74	150	49	1	TR AS-RF	925,00 1.155,00			1.205,00 1.505,00
158,3-162,3	<b>B3987</b>	157-161	73,4	79,1	78	158	52	2	TR AS-RF	965,00 1.205,00			1.255,00 1.570,00
168,3-172,3	<b>B3988</b>	167-171	72,3	90,3	89	180	60	2	TR AS-RF	990,00 1.240,00			1.285,00 1.605,00
178,3-182,3	<b>B3990</b>	177-181	82,3	90,3	89	180	65	2	TR AS-RF	1.020,00 1.275,00			1.325,00 1.655,00

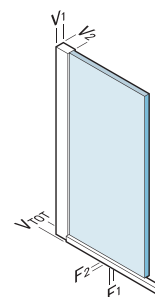

L	V1	V2	V <sub>TOT</sub>	F1	F2
	35mm	38mm	39mm	9mm	9mm

## PARETE FISSA / FIXED PANEL

L1 [cm]	COD.	L1 NOM. [cm]	A [cm]	B [cm]	C [cm]	[dm <sup>3</sup> ]	[kg]	[n°]	V	ULU	L96	L91	DOLCEVITA
65,8-68,3	<b>B3850</b>	64-66,5	-	-	-	99	29	1	TR AS-RF	490,00 615,00			635,00 795,00
68,3-70,8	<b>B3851</b>	66,5-69	-	-	-	101	29	1	TR AS-RF	495,00 620,00			645,00 805,00
70,8-73,3	<b>B3852</b>	69-71,5	-	-	-	102	29	1	TR AS-RF	500,00 625,00			650,00 815,00
73,3-75,8	<b>B3853</b>	71,5-74	-	-	-	112	29	1	TR AS-RF	500,00 625,00			650,00 815,00
75,8-78,3	<b>B3854</b>	74-76,5	-	-	-	115	30	1	TR AS-RF	505,00 630,00			655,00 820,00
78,3-80,8	<b>B3855</b>	76,5-79	-	-	-	117	31	1	TR AS-RF	505,00 630,00			655,00 820,00
80,8-83,3	<b>B3856</b>	79-81,5	-	-	-	120	34	1	TR AS-RF	510,00 640,00			665,00 830,00
83,3-85,8	<b>B3857</b>	81,5-84	-	-	-	137	35	1	TR AS-RF	515,00 645,00			670,00 840,00
85,8-88,3	<b>B3858</b>	84-86,5	-	-	-	140	35	1	TR AS-RF	520,00 650,00			675,00 845,00
83,3-90,8	<b>B3860</b>	86,5-89	-	-	-	143	35	1	TR AS-RF	530,00 665,00			690,00 865,00
90,8-93,3	<b>B3861</b>	89-91,5	-	-	-	144	36	1	TR AS-RF	530,00 665,00			690,00 865,00
98,3-100,8	<b>B3862</b>	96,5-99	-	-	-	156	37	1	TR AS-RF	550,00 690,00			715,00 895,00
100,8-103,3	<b>B3863</b>	99-101,5	-	-	-	160	38	1	TR AS-RF	570,00 715,00			740,00 925,00
108,3-110,8	<b>B3864</b>	106,5-109	-	-	-	162	39	1	TR AS-RF	585,00 730,00			760,00 950,00
110,8-113,3	<b>B3865</b>	109-111,5	-	-	-	165	40	1	TR AS-RF	605,00 755,00			785,00 980,00
118,3-120,8	<b>B3866</b>	116,5-119	-	-	-	168	41	1	TR AS-RF	625,00 780,00			815,00 1.020,00
120,8-123,3	<b>B3867</b>	119-121,5	-	-	-	170	42	1	TR AS-RF	645,00 805,00			840,00 1.050,00

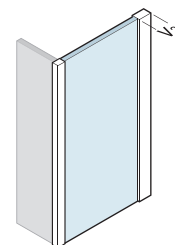

L1	L2
	42mm

H. 195cm  
SP. 6mm

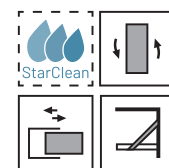

SU MISURA/CUSTOM	PORTA DOOR	[€]	PARETE FISSA FIXED PANEL	[€]
Altezza/Height <sup>1</sup>	150-217cm	+20%	50-217cm	+20%
Larghezza/Width <sup>2</sup>	60-180cm	+20%	15-160cm	+20%
Altezza/Height Larghezza/Width <sup>2</sup>	150-217cm 60-180cm	+20%	50-217cm 15-160cm	+20%
Altre forme Other shapes <sup>2</sup>		+30%		+30%

OPTIONAL	COD.	[€]
Maniglia/Handle 16cm <sup>3</sup>	<b>H00</b>	40,00
Maniglia/Handle 32cm <sup>3</sup>	<b>L00</b>	50,00
Maniglia/Handle 32cm <sup>3</sup>	<b>N00</b>	50,00
Kit di sostegno Support kit <sup>3</sup>	<b>KT3800</b>	150,00
	(L.200cm)	195,00
	Porta/Door	50,00
	Parete Fissa/Fixed Panel	50,00

<sup>1</sup> Dal prezzo della misura di riferimento / From the price of selected size

<sup>2</sup> Dal prezzo della misura superiore / From the price of the larger size

<sup>3</sup> Da richiedere al momento dell'ordine / To be requested at the time of order

<sup>4</sup> Contattare l'ufficio clienti per informazioni / Contact the customer service office for information

### DISPONIBILITA' A MAGAZZINO / STOCK AVAILABILITY

1/2 Settimane/Weeks	2/3 Settimane/Weeks	3/4 Settimane/Weeks
+1 StarClean Optional		

# POLARIS

PORTA BATTENTE CON DUE FISSI IN LINEA  
HINGED DOOR WITH TWO INLINE FIXED PANELS



Per istruzioni di montaggio  
e ricambi inquadra il codice QR  
For assembly instructions  
and spare parts, scan the QR code



H. 195cm  
SP. 6mm

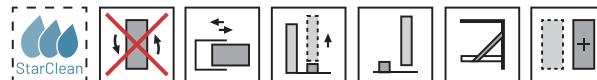

Parete doccia con apertura a porta battente con doppia parete fissa in linea. L'apertura dell'anta è sia verso l'interno che verso l'esterno. Modello ad alto impatto estetico e disponibile in dimensioni maggiori rispetto ad una tradizionale porta.

Shower enclosure with a hinged door and two inline fixed panels. The door opens both inward and outward. A model with a high aesthetic impact, available in larger sizes compared to a traditional door.

## CONFIGURAZIONE IN NICCHIA NICHE CONFIGURATION

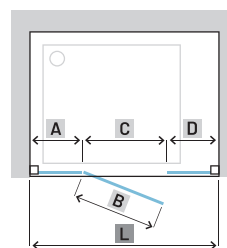

## CONFIGURAZIONI IN ANGOLO E A TRE LATI CORNER AND THREE-SIDED CONFIGURATIONS

Non è possibile realizzare configurazioni in angolo.  
Non è possibile realizzare configurazioni a tre lati.  
It is not possible to create corner configurations.  
It is not possible to create three-sided configurations.

## ORIENTAMENTO E POSSIBILI COMBINAZIONI / ORIENTATION AND POSSIBLE CONFIGURATIONS

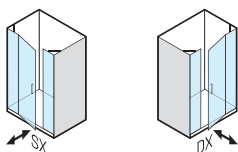

### PROFILI / PROFILES

STANDARD	
ULU	Brillantato Lucido Brilliant Polished
L91	Bianco Opaco Matte White
L96	Nero Opaco Matte Black

DOLCEVITA	
SNK	Nickel Spazzolato Nickel Brushed
AL4	Bronzo Spazzolato Brushed Bronze
AL5	Oro Rosa Lucido Polished Rose Gold
GLB	Oro Spazzolato Brushed Gold
GLP	Oro Lucido Polished Gold
GMB	Gun Metal Spazzolato Brushed Gun Metal

### VETRO / GLASS

STANDARD		
TR	Trasparente Transparent	
AS	Satinato Satin	
RF	Fascia H.100cm Band H.100cm	
ON DEMAND		
ST	Stampato Printed	TR +10%
TE	Extrachiario Extra Clear	TR +25%
TG	Trasparente Grigio Transparent Grey	TR +25%
GS	Satinato Grigio Satin Grey	TR +25%
SY	Specchio Mirror <sup>4</sup>	TR +50%

**PORTA / DOOR**

L [cm]	COD.	A [cm]	B [cm]	C [cm]	D [cm]	[dm <sup>3</sup> ]	[kg]	[n°]	V	ULU L96 L91	DOLCEVITA
97-102	<b>B3880</b>	23,1	52,5	51	21,5	138	38	1	TR	1.080,00	1.405,00
									AS-RF	1.350,00	1.755,00
102-107	<b>B3881</b>	25,5	52,5	51	23,9	132	38	1	TR	1.090,00	1.415,00
									AS-RF	1.365,00	1.770,00
107-112	<b>B3882</b>	25	58,5	57	23,4	142	39	1	TR	1.095,00	1.425,00
									AS-RF	1.370,00	1.780,00
11-117	<b>B3883</b>	27,5	58,5	57	25,9	146	41	1	TR	1.100,00	1.430,00
									AS-RF	1.375,00	1.790,00
117-122	<b>B3884</b>	28,6	61,2	60	27	152	43	1	TR	1.105,00	1.435,00
									AS-RF	1.380,00	1.795,00
122-127	<b>B3885</b>	30,2	63,2	62	28,6	158	45	1	TR	1.115,00	1.450,00
									AS-RF	1.395,00	1.815,00
127-132	<b>B3886</b>	32,6	63,2	62	31	162	46	1	TR	1.120,00	1.455,00
									AS-RF	1.400,00	1.820,00
132-137	<b>B3887</b>	32,2	69,2	68	30,6	172	47	1	TR	1.130,00	1.470,00
									AS-RF	1.415,00	1.840,00
137-142	<b>B3888</b>	32,6	73,2	72	31	179	49	1	TR	1.135,00	1.475,00
									AS-RF	1.420,00	1.845,00
142-147	<b>B3890</b>	35,2	73,2	72	33,6	184	51	1	TR	1.145,00	1.490,00
									AS-RF	1.430,00	1.865,00
147-152	<b>B3891</b>	37,6	73,2	72	36	188	52	2	TR	1.150,00	1.495,00
									AS-RF	1.440,00	1.870,00
157-162	<b>B3892</b>	41,6	75,2	74	40	198	54	2	TR	1.175,00	1.530,00
									AS-RF	1.470,00	1.915,00
167-172	<b>B3893</b>	44,7	79,2	78	43,1	210	60	2	TR	1.205,00	1.565,00
									AS-RF	1.505,00	1.955,00
177-182	<b>B3894</b>	46,3	86	85	44,7	225	64	2	TR	1.230,00	1.600,00
									AS-RF	1.540,00	2.000,00

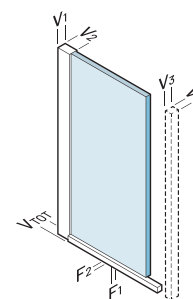

L	
V <sub>1</sub>	45mm
V <sub>2</sub>	42mm
V <sub>3</sub>	24mm
V <sub>4</sub>	23mm
V <sub>TOT</sub>	52mm
F <sub>1</sub>	9mm
F <sub>2</sub>	9mm

SU MISURA/CUSTOM	PORTA DOOR	[€]
▲▼ Altezza/Height <sup>1</sup>	130-217cm	+20%
◀▶ Larghezza/Width <sup>2</sup>	97-200cm	+20%
◆ Altezza/Height Larghezza/Width <sup>2</sup>	130-217cm 97-200cm	+20%
Altre forme Other shapes <sup>2</sup>		+30%

OPTIONAL	COD.	[€]
Maniglia/Handle 16cm <sup>3</sup>	<b>H00</b>	40,00
Maniglia/Handle 32cm <sup>3</sup>	<b>L00</b>	50,00
Maniglia/Handle 32cm <sup>3</sup>	<b>N00</b>	50,00
StarClean	Porta/Door	100,00

<sup>1</sup> Dal prezzo della misura di riferimento / From the price of selected size

<sup>2</sup> Dal prezzo della misura superiore / From the price of the larger size

<sup>3</sup> Da richiedere al momento dell'ordine / To be requested at the time of order

<sup>4</sup> Contattare l'ufficio clienti per informazioni / Contact the customer service office for information

DISPONIBILITA' A MAGAZZINO / STOCK AVAILABILITY

1/2 Settimane/Weeks

2/3 Settimane/Weeks

3/4 Settimane/Weeks

+1 StarClean Optional

# POLARIS

PORTA BATTENTE CON DUE FISSI IN LINEA + PARETE FISSA  
HINGED DOOR WITH TWO INLINE FIXED PANELS + FIXED PANEL



Per istruzioni di montaggio  
e ricambi inquadra il codice QR  
For assembly instructions  
and spare parts, scan the QR code



H. 195cm  
SP. 6mm

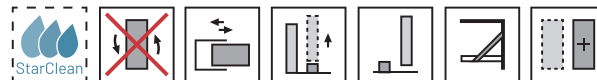

Parete doccia in configurazione ad angolo formata da porta battente con doppia parete fissa in linea più parete fissa. L'apertura dell'anta è sia verso l'interno che verso l'esterno. Modello ad alto impatto estetico e disponibile in dimensioni maggiori rispetto ad una tradizionale porta.

Corner shower enclosure configuration consisting of a hinged door with two inline fixed panels and an additional fixed panel. The door opens both inward and outward. A model with a high aesthetic impact, available in larger sizes compared to a traditional door.

## CONFIGURAZIONE AD ANGOLO CORNER CONFIGURATION

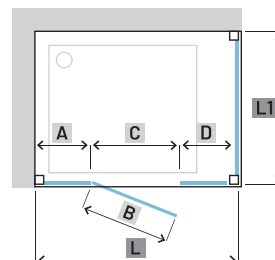

### CONFIGURAZIONI IN NICCHIA E A TRE LATI NICHE AND THREE-SIDED CONFIGURATIONS

Non è possibile realizzare configurazioni in nicchia.  
Non è possibile realizzare configurazioni a tre lati.  
It is not possible to create niche configurations.  
It is not possible to create three-sided configurations.

## ORIENTAMENTO E POSSIBILI COMBINAZIONI / ORIENTATION AND POSSIBLE CONFIGURATIONS

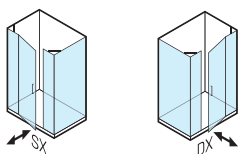

### PROFILI / PROFILES

STANDARD	
ULU	Brillantato Lucido Brilliant Polished
L91	Bianco Opaco Matte White
L96	Nero Opaco Matte Black

DOLCEVITA	
SNK	Nickel Spazzolato Nickel Brushed
AL4	Bronzo Spazzolato Brushed Bronze
AL5	Oro Rosa Lucido Polished Rose Gold
GLB	Oro Spazzolato Brushed Gold
GLP	Oro Lucido Polished Gold
GMB	Gun Metal Spazzolato Brushed Gun Metal

### VETRO / GLASS

STANDARD		
TR	Trasparente Transparent	
AS	Satinato Satin	
RF	Fascia H.100cm Band H.100cm	
ON DEMAND		
ST	Stampato Printed	TR +10%
TE	Extrachiario Extra Clear	TR +25%
TG	Trasparente Grigio Transparent Grey	TR +25%
GS	Satinato Grigio Satin Grey	TR +25%
SY	Specchio Mirror <sup>4</sup>	TR +50%

**PORTA / DOOR**

L [cm]	COD.	L NOM. [cm]	A [cm]	B [cm]	C [cm]	D [cm]	[dm3]	[kg]	[n°]	V	ULU	L96	L91	DOLCEVITA
98,3-103,3	<b>B3880</b>	97-102	23,1	52,5	51	21,5	138	38	1	TR AS-RF	1.080,00 1.350,00			1.405,00 1.755,00
103,3-108,3	<b>B3881</b>	102-107	25,5	52,5	51	23,9	132	38	1	TR AS-RF	1.090,00 1.365,00			1.415,00 1.770,00
108,3-113,3	<b>B3882</b>	107-112	25	58,5	57	23,4	142	39	1	TR AS-RF	1.095,00 1.370,00			1.425,00 1.780,00
113,3-118,3	<b>B3883</b>	11-117	27,5	58,5	57	25,9	146	41	1	TR AS-RF	1.100,00 1.375,00			1.430,00 1.790,00
118,3-123,3	<b>B3884</b>	117-122	28,6	61,2	60	27	152	43	1	TR AS-RF	1.105,00 1.380,00			1.435,00 1.795,00
123,3-128,3	<b>B3885</b>	122-127	30,2	63,2	62	28,6	158	45	1	TR AS-RF	1.115,00 1.395,00			1.450,00 1.815,00
128,3-133,3	<b>B3886</b>	127-132	32,6	63,2	62	31	162	46	1	TR AS-RF	1.120,00 1.400,00			1.455,00 1.820,00
133,3-138,3	<b>B3887</b>	132-137	32,2	69,2	68	30,6	172	47	1	TR AS-RF	1.130,00 1.415,00			1.470,00 1.840,00
138,3-143,3	<b>B3888</b>	137-142	32,6	73,2	72	31	179	49	1	TR AS-RF	1.135,00 1.420,00			1.475,00 1.845,00
143,3-148,3	<b>B3890</b>	142-147	35,2	73,2	72	33,6	184	51	1	TR AS-RF	1.145,00 1.430,00			1.490,00 1.865,00
148,3-153,3	<b>B3891</b>	147-152	37,6	73,2	72	36	188	52	2	TR AS-RF	1.150,00 1.440,00			1.495,00 1.870,00
158,3-163,3	<b>B3892</b>	157-162	41,6	75,2	74	40	198	54	2	TR AS-RF	1.175,00 1.470,00			1.530,00 1.915,00
168,3-173,3	<b>B3893</b>	167-172	44,7	79,2	78	43,1	210	60	2	TR AS-RF	1.205,00 1.505,00			1.565,00 1.955,00
178,3-183,3	<b>B3894</b>	177-182	46,3	86	85	44,7	225	64	2	TR AS-RF	1.230,00 1.540,00			1.600,00 2.000,00

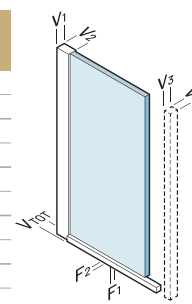

L	V1	V2	V3	V4	Vtot	F1	F2
	45mm	42mm	24mm	23mm	52mm	9mm	9mm

**PARETE FISSA / FIXED PANEL**

L1 [cm]	COD.	L1 NOM. [cm]	A [cm]	B [cm]	C [cm]	D [cm]	[dm3]	[kg]	[n°]	V	ULU	L96	L91	DOLCEVITA
65,8-68,3	<b>B3850</b>	64-66,5	-	-	-	-	99	29	1	TR AS-RF	490,00 615,00			635,00 795,00
68,3-70,8	<b>B3851</b>	66,5-69	-	-	-	-	101	29	1	TR AS-RF	495,00 620,00			645,00 805,00
70,8-73,3	<b>B3852</b>	69-71,5	-	-	-	-	102	29	1	TR AS-RF	500,00 625,00			650,00 815,00
73,3-75,8	<b>B3853</b>	71,5-74	-	-	-	-	112	29	1	TR AS-RF	500,00 625,00			650,00 815,00
75,8-78,3	<b>B3854</b>	74-76,5	-	-	-	-	115	30	1	TR AS-RF	505,00 630,00			655,00 820,00
78,3-80,8	<b>B3855</b>	76,5-79	-	-	-	-	117	31	1	TR AS-RF	505,00 630,00			655,00 820,00
80,8-83,3	<b>B3856</b>	79-81,5	-	-	-	-	120	34	1	TR AS-RF	510,00 640,00			665,00 830,00
83,3-85,8	<b>B3857</b>	81,5-84	-	-	-	-	137	35	1	TR AS-RF	515,00 645,00			670,00 840,00
85,8-88,3	<b>B3858</b>	84-86,5	-	-	-	-	140	35	1	TR AS-RF	520,00 650,00			675,00 845,00
83,3-90,8	<b>B3860</b>	86,5-89	-	-	-	-	143	35	1	TR AS-RF	530,00 665,00			690,00 865,00
90,8-93,3	<b>B3861</b>	89-91,5	-	-	-	-	144	36	1	TR AS-RF	530,00 665,00			690,00 865,00
98,3-100,8	<b>B3862</b>	96,5-99	-	-	-	-	156	37	1	TR AS-RF	550,00 690,00			715,00 895,00
100,8-103,3	<b>B3863</b>	99-101,5	-	-	-	-	160	38	1	TR AS-RF	570,00 715,00			740,00 925,00
108,3-110,8	<b>B3864</b>	106,5-109	-	-	-	-	162	39	1	TR AS-RF	585,00 730,00			760,00 950,00
110,8-113,3	<b>B3865</b>	109-111,5	-	-	-	-	165	40	1	TR AS-RF	605,00 755,00			785,00 980,00
118,3-120,8	<b>B3866</b>	116,5-119	-	-	-	-	168	41	1	TR AS-RF	625,00 780,00			815,00 1.020,00
120,8-123,3	<b>B3867</b>	119-121,5	-	-	-	-	170	42	1	TR AS-RF	645,00 805,00			840,00 1.050,00

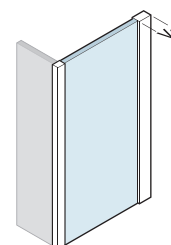

L1	L2
	42mm

**H. 195cm  
SP. 6mm**

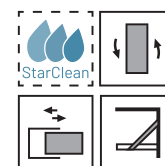

SU MISURA/CUSTOM	PORTA DOOR	[€]	PARETE FISSA FIXED PANEL	[€]
Altezza/Height <sup>1</sup>	130-217cm	+20%	50-217cm	+20%
Larghezza/Width <sup>2</sup>	97-200cm	+20%	15-160cm	+20%
Altezza/Height	130-217cm	+20%	50-217cm	+20%
Larghezza/Width <sup>2</sup>	97-200cm	+20%	15-160cm	+20%
Altre forme Other shapes <sup>2</sup>		+30%		+30%

OPTIONAL	COD.	[€]
Maniglia/Handle 16cm <sup>3</sup>	<b>H00</b>	40,00
Maniglia/Handle 32cm <sup>3</sup>	<b>L00</b>	50,00
Maniglia/Handle 32cm <sup>3</sup>	<b>N00</b>	50,00
Kit di sostegno Support kit <sup>3</sup>	<b>KT3800</b>	150,00
	(L.200cm)	195,00
	Porta/Door	100,00
	Parete Fissa/Fixed Panel	50,00

<sup>1</sup> Dal prezzo della misura di riferimento / From the price of selected size

<sup>2</sup> Dal prezzo della misura superiore / From the price of the larger size

<sup>3</sup> Da richiedere al momento dell'ordine / To be requested at the time of order

<sup>4</sup> Contattare l'ufficio clienti per informazioni / Contact the customer service office for information

**DISPONIBILITA' A MAGAZZINO / STOCK AVAILABILITY**

1/2 Settimane/Weeks	2/3 Settimane/Weeks	3/4 Settimane/Weeks
+1 StarClean Optional		

# POLARIS

PORTA SALOON  
SALOON DOOR



Per istruzioni di montaggio  
e ricambi inquadra il codice QR  
For assembly instructions  
and spare parts, scan the QR code



**H. 195cm**  
**SP. 6mm**

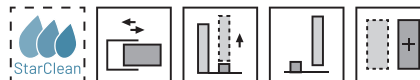

Parete doccia con due ante con apertura a saloon. L'apertura delle ante è sia verso l'interno che verso l'esterno. Modello adatto per situazioni che necessitano di un ingresso ampio, ma con spazio di installazione limitato.

Shower enclosure with two saloon-style doors. The doors open both inward and outward. A model suitable for situations requiring a wide entry but with limited installation space.

### CONFIGURAZIONE IN NICCHIA NICHE CONFIGURATION

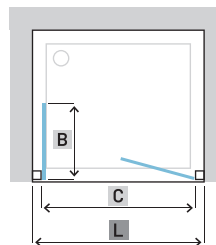

### CONFIGURAZIONI IN ANGOLO E A TRE LATI CORNER AND THREE-SIDED CONFIGURATIONS

Non è possibile realizzare configurazioni in angolo.  
Non è possibile realizzare configurazioni a tre lati.  
It is not possible to create corner configurations.  
It is not possible to create three-sided configurations.

## ORIENTAMENTO E POSSIBILI COMBINAZIONI / ORIENTATION AND POSSIBLE CONFIGURATIONS

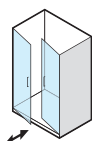

### PROFILI / PROFILES

STANDARD	
ULU	Brillantato Lucido Brilliant Polished
L91	Bianco Opaco Matte White
L96	Nero Opaco Matte Black

DOLCEVITA	
SNK	Nickel Spazzolato Nickel Brushed
AL4	Bronzo Spazzolato Brushed Bronze
AL5	Oro Rosa Lucido Polished Rose Gold
GLB	Oro Spazzolato Brushed Gold
GLP	Oro Lucido Polished Gold
GMB	Gun Metal Spazzolato Brushed Gun Metal

### VETRO / GLASS

STANDARD		
TR	Trasparente Transparent	
AS	Satinato Satin	
RF	Fascia H.100cm Band H.100cm	
ON DEMAND		
ST	Stampato Printed	TR +10%
TE	Extrachiario Extra Clear	TR +25%
TG	Trasparente Grigio Transparent Grey	TR +25%
GS	Satinato Grigio Satin Grey	TR +25%
SY	Specchio Mirror <sup>4</sup>	TR +50%

**PORTA / DOOR**

L [cm]	COD.	B [cm]	C [cm]	[dm <sup>3</sup> ]	[kg]	[n°]	V	ULU L96 L91	DOLCEVITA
64-68	B3920	27,8	53	70	26	1	TR	790,00	1.025,00
							AS-RF	990,00	1.280,00
68-72	B3921	29,8	57	75	27	1	TR	800,00	1.040,00
							AS-RF	1.000,00	1.300,00
72-76	B3922	31,8	61	77	28	1	TR	805,00	1.045,00
							AS-RF	1.005,00	1.305,00
76-80	B3923	33,8	65	79	28	1	TR	815,00	1.060,00
							AS-RF	1.020,00	1.325,00
80-84	B3924	35,8	69	79	29	1	TR	825,00	1.075,00
							AS-RF	1.030,00	1.345,00
84-88	B3925	37,8	73	81	30	1	TR	835,00	1.085,00
							AS-RF	1.045,00	1.355,00
88-92	B3926	39,8	77	84	31	1	TR	845,00	1.100,00
							AS-RF	1.055,00	1.375,00
92-96	B3927	41,8	81	93	33	1	TR	855,00	1.110,00
							AS-RF	1.070,00	1.390,00
96-100	B3928	43,8	85	100	35	1	TR	860,00	1.120,00
							AS-RF	1.075,00	1.400,00

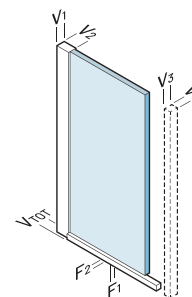

L	
V <sub>1</sub>	35mm
V <sub>2</sub>	38mm
V <sub>3</sub>	24mm
V <sub>4</sub>	23mm
V <sub>TOT</sub>	39mm
F <sub>1</sub>	9mm
F <sub>2</sub>	9mm

SU MISURA/CUSTOM	PORTA DOOR	[€]
↕ Altezza/Height <sup>1</sup>	100-217cm	+20%
↔ Larghezza/Width <sup>2</sup>	50-145cm	+20%
↕ Altezza/Height ↔ Larghezza/Width <sup>2</sup>	100-217cm 50-145cm	+20%
Altre forme Other shapes <sup>2</sup>		+30%

OPTIONAL	COD.	[€]
Maniglia/Handle 16cm <sup>3</sup>	H00	40,00
Maniglia/Handle 32cm <sup>3</sup>	L00	50,00
Maniglia/Handle 32cm <sup>3</sup>	N00	50,00
 StarClean	Porta/Door	50,00

<sup>1</sup> Dal prezzo della misura di riferimento / From the price of selected size

<sup>2</sup> Dal prezzo della misura superiore / From the price of the larger size

<sup>3</sup> Da richiedere al momento dell'ordine / To be requested at the time of order

<sup>4</sup> Contattare l'ufficio clienti per informazioni / Contact the customer service office for information

DISPONIBILITA' A MAGAZZINO / STOCK AVAILABILITY

1/2 Settimane/Weeks

2/3 Settimane/Weeks

3/4 Settimane/Weeks

+1 StarClean Optional

# POLARIS

PORTA SALOON + PARETE FISSA  
SALOON DOOR + FIXED PANEL



Per istruzioni di montaggio  
e ricambi inquadra il codice QR  
For assembly instructions  
and spare parts, scan the QR code



H. 195cm  
SP. 6mm

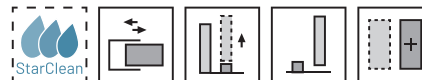

Parete doccia in configurazione ad angolo formata da due ante con apertura a saloon più parete fissa. L'apertura delle ante è sia verso l'interno che verso l'esterno. Modello adatto per situazioni che necessitano di un ingresso ampio, ma con spazio di installazione limitato. KT3920 da acquistare obbligatoriamente.

Corner shower enclosure configuration consisting of two saloon-style doors and a fixed panel. The doors open both inward and outward. A model suitable for situations requiring a wide entrance but with limited installation space. KT3920 is mandatory to purchase.

## CONFIGURAZIONE AD ANGOLO CORNER CONFIGURATION

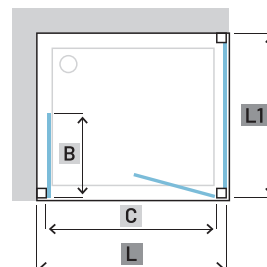

### CONFIGURAZIONI IN NICCHIA E A TRE LATI NICHE AND THREE-SIDED CONFIGURATIONS

Non è possibile realizzare configurazioni in nicchia.  
Non è possibile realizzare configurazioni a tre lati.  
It is not possible to create niche configurations.  
It is not possible to create three-sided configurations.

## ORIENTAMENTO E POSSIBILI COMBINAZIONI / ORIENTATION AND POSSIBLE CONFIGURATIONS

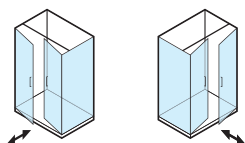

### PROFILI / PROFILES

STANDARD	
ULU	Brillantato Lucido Brilliant Polished
L91	Bianco Opaco Matte White
L96	Nero Opaco Matte Black

DOLCEVITA	
SNK	Nickel Spazzolato Nickel Brushed
AL4	Bronzo Spazzolato Brushed Bronze
AL5	Oro Rosa Lucido Polished Rose Gold
GLB	Oro Spazzolato Brushed Gold
GLP	Oro Lucido Polished Gold
GMB	Gun Metal Spazzolato Brushed Gun Metal

### VETRO / GLASS

STANDARD		
TR	Trasparente Transparent	
AS	Satinato Satin	
RF	Fascia H.100cm Band H.100cm	
ON DEMAND		
ST	Stampato Printed	TR +10%
TE	Extrachiario Extra Clear	TR +25%
TG	Trasparente Grigio Transparent Grey	TR +25%
GS	Satinato Grigio Satin Grey	TR +25%
SY	Specchio Mirror <sup>4</sup>	TR +50%

## PORTA / DOOR

L [cm]	COD.	L NOM. [cm]	B [cm]	C [cm]	[dm <sup>3</sup> ]	[kg]	[n°]	V	ULU	L96	L91	DOLCEVITA
65,4-69,4	<b>B3920</b>	64-68	27,8	53	70	26	1	TR	790,00			1.025,00
								AS-RF	990,00		1.280,00	
69,4-73,4	<b>B3921</b>	68-72	29,8	57	75	27	1	TR	800,00			1.040,00
								AS-RF	1.000,00		1.300,00	
73,4-77,4	<b>B3922</b>	72-76	31,8	61	77	28	1	TR	805,00			1.045,00
								AS-RF	1.005,00		1.305,00	
77,4-81,4	<b>B3923</b>	76-80	33,8	65	79	28	1	TR	815,00			1.060,00
								AS-RF	1.020,00		1.325,00	
81,4-85,4	<b>B3924</b>	80-84	35,8	69	79	29	1	TR	825,00			1.075,00
								AS-RF	1.030,00		1.345,00	
85,4-89,4	<b>B3925</b>	84-88	37,8	73	81	30	1	TR	835,00			1.085,00
								AS-RF	1.045,00		1.355,00	
89,4-93,4	<b>B3926</b>	88-92	39,8	77	84	31	1	TR	845,00			1.100,00
								AS-RF	1.055,00		1.375,00	
93,4-97,4	<b>B3927</b>	92-96	41,8	81	93	33	1	TR	855,00			1.110,00
								AS-RF	1.070,00		1.390,00	
97,4-101,4	<b>B3928</b>	96-100	43,8	85	100	35	1	TR	860,00			1.120,00
								AS-RF	1.075,00		1.400,00	

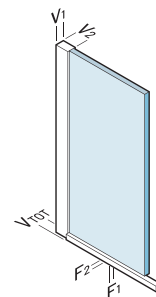

L	
V <sub>1</sub>	35mm
V <sub>2</sub>	38mm
V <sub>TOT</sub>	39mm
F <sub>1</sub>	9mm
F <sub>2</sub>	9mm

## PARETE FISSA / FIXED PANEL

L1 [cm]	COD.	L1 NOM. [cm]	B [cm]	C [cm]	[dm <sup>3</sup> ]	[kg]	[n°]	V	ULU	L96	L91	DOLCEVITA
64,8-67,3	<b>B3850</b>	64-66,5	-	-	99	29	1	TR	490,00			635,00
								AS-RF	615,00		795,00	
67,3-69,8	<b>B3851</b>	66,5-69	-	-	101	29	1	TR	495,00			645,00
								AS-RF	620,00		805,00	
69,8-72,3	<b>B3852</b>	69-71,5	-	-	102	29	1	TR	500,00			650,00
								AS-RF	625,00		815,00	
72,3-74,8	<b>B3853</b>	71,5-74	-	-	112	29	1	TR	500,00			650,00
								AS-RF	625,00		815,00	
74,8-77,3	<b>B3854</b>	74-76,5	-	-	115	30	1	TR	505,00			655,00
								AS-RF	630,00		820,00	
77,3-79,8	<b>B3855</b>	76,5-79	-	-	117	31	1	TR	505,00			655,00
								AS-RF	630,00		820,00	
79,8-82,3	<b>B3856</b>	79-81,5	-	-	120	34	1	TR	510,00			665,00
								AS-RF	640,00		830,00	
82,3-84,8	<b>B3857</b>	81,5-84	-	-	137	35	1	TR	515,00			670,00
								AS-RF	645,00		840,00	
84,8-87,3	<b>B3858</b>	84-86,5	-	-	140	35	1	TR	520,00			675,00
								AS-RF	650,00		845,00	
87,3-89,8	<b>B3860</b>	86,5-89	-	-	143	35	1	TR	530,00			690,00
								AS-RF	665,00		865,00	
89,8-92,3	<b>B3861</b>	89-91,5	-	-	144	36	1	TR	530,00			690,00
								AS-RF	665,00		865,00	
97,3-99,8	<b>B3862</b>	96,5-99	-	-	156	37	1	TR	550,00			715,00
								AS-RF	690,00		895,00	
99,8-102,3	<b>B3863</b>	99-101,5	-	-	160	38	1	TR	570,00			740,00
								AS-RF	715,00		925,00	
107,3-109,8	<b>B3864</b>	106,5-109	-	-	162	39	1	TR	585,00			760,00
								AS-RF	730,00		950,00	
109,8-112,3	<b>B3865</b>	109-111,5	-	-	165	40	1	TR	605,00			785,00
								AS-RF	755,00		980,00	
117,3-119,8	<b>B3866</b>	116,5-119	-	-	168	41	1	TR	625,00			815,00
								AS-RF	780,00		1.020,00	
119,8-122,3	<b>B3867</b>	119-121,5	-	-	170	42	1	TR	645,00			840,00
								AS-RF	805,00		1.050,00	

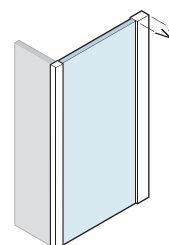

L1	
L <sub>1</sub>	42mm

H. 195cm  
SP. 6mm

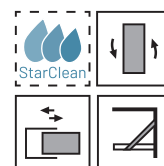

SU MISURA/CUSTOM	PORTA DOOR	[€]	PARETE FISSA FIXED PANEL	[€]
▲ ▼ Altezza/Height <sup>1</sup>	100-217cm	+20%	50-217cm	+20%
◀ ▶ Larghezza/Width <sup>2</sup>	50-145cm	+20%	15-160cm	+20%
◆ Altezza/Height Larghezza/Width <sup>2</sup>	100-217cm 50-145cm	+20%	50-217cm 15-160cm	+20%
Altre forme Other shapes <sup>2</sup>		+30%		+30%

OPTIONAL	COD.	[€]
Maniglia/Handle 16cm <sup>3</sup>	<b>H00</b>	40,00
Maniglia/Handle 32cm <sup>3</sup>	<b>L00</b>	50,00
Maniglia/Handle 32cm <sup>3</sup>	<b>N00</b>	50,00
Kit di sostegno obbligatorio Mandatory support kit <sup>3</sup>	<b>KT3920</b> (L.140cm)	135,00
StarClean	Porta/Door	50,00
	Parete Fissa/Fixed Panel	50,00

<sup>1</sup> Dal prezzo della misura di riferimento / From the price of selected size

<sup>2</sup> Dal prezzo della misura superiore / From the price of the larger size

<sup>3</sup> Da richiedere al momento dell'ordine / To be requested at the time of order

<sup>4</sup> Contattare l'ufficio clienti per informazioni / Contact the customer service office for information

DISPONIBILITA' A MAGAZZINO / STOCK AVAILABILITY

1/2 Settimane/Weeks

2/3 Settimane/Weeks

3/4 Settimane/Weeks

+1 StarClean Optional

# POLARIS

TONDO DOPPIA PORTA BATTENTE  
ROUND DOUBLE SWING DOOR



Per istruzioni di montaggio  
e ricambi inquadra il codice QR  
For assembly instructions  
and spare parts, scan the QR code



H. 195cm  
SP. 6mm

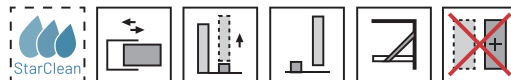

Parete doccia stondata disponibile in versioni per installazioni in angolo in dimensioni quadrate o. Il modello dispone di quattro ante di cui le due centrali battenti apribili.

*Rounded shower enclosure available in corner installation versions in square dimensions. The model features four panels, with the two central panels being hinged and operable.*

## CONFIGURAZIONE AD ANGOLO CORNER CONFIGURATION

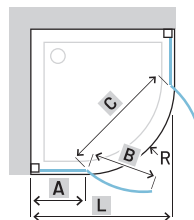

**B3873** R 55cm  
**B3872** R 55cm  
**B3874** R 55cm

## CONFIGURAZIONI IN NICCHIA E A TRE LATI NICHE AND THREE-SIDED CONFIGURATIONS

Non è possibile realizzare configurazioni in nicchia.  
Non è possibile realizzare configurazioni a tre lati.  
*It is not possible to create niche configurations.  
It is not possible to create three-sided configurations.*



## ORIENTAMENTO E POSSIBILI COMBINAZIONI / ORIENTATION AND POSSIBLE CONFIGURATIONS

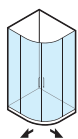

### PROFILI / PROFILES

STANDARD	
ULU	Brillantato Lucido <i>Brilliant Polished</i>
L91	Bianco Opaco <i>Matte White</i>
L96	Nero Opaco <i>Matte Black</i>

DOLCEVITA	
SNK	Nickel Spazzolato <i>Nickel Brushed</i>
AL4	Bronzo Spazzolato <i>Brushed Bronze</i>
AL5	Oro Rosa Lucido <i>Polished Rose Gold</i>
GLB	Oro Spazzolato <i>Brushed Gold</i>
GLP	Oro Lucido <i>Polished Gold</i>
GMB	Gun Metal Spazzolato <i>Brushed Gun Metal</i>

### VETRO / GLASS

STANDARD	
TR	Trasparente <i>Transparent</i>
AS	Satinato <i>Satin</i>
RF	Fascia H.100cm <i>Band H.100cm</i>

**PORTA / DOOR**

L [cm]	COD.	L NOM. [cm]	A [cm]	B [cm]	C [cm]	[dm <sup>3</sup> ]	[kg]	[n°]	V	ULU	L96	L91	DOLCEVITA
77,3-79,8	<b>B3873</b>	75,5-78	22,1	40,6	73	266	50	2	TR	1.475,00			1.920,00
									AS-RF	1.845,00			2.400,00
87,3-89,8	<b>B3872</b>	85,5-88	32,1	40,6	73	300	50	2	TR	1.520,00			1.975,00
									AS-RF	1.900,00			2.470,00
97,3-99,8	<b>B3874</b>	95,5-98	42,1	40,6	73	320	52	2	TR	1.565,00			2.035,00
									AS-RF	1.955,00			2.545,00

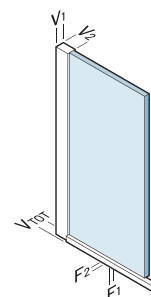

L	
V <sub>1</sub>	45mm
V <sub>2</sub>	42mm
V <sub>TOT</sub>	52mm
F <sub>1</sub>	9mm
F <sub>2</sub>	9mm

SU MISURA/CUSTOM	PORTA DOOR	[€]
↕ Altezza/Height <sup>1</sup>	Vedi nota/See note <sup>3</sup>	-
↔ Larghezza/Width <sup>2</sup>	Vedi nota/See note <sup>3</sup>	+20%
↕↔ Altezza/Height Larghezza/Width <sup>2</sup>	Vedi nota/See note <sup>3</sup>	-
Altre forme Other shapes <sup>2</sup>		+30%

OPTIONAL	COD.	[€]
StarClean	Porta/Door	100,00

<sup>1</sup> Dal prezzo della misura di riferimento/From the price of selected size

<sup>2</sup> Dal prezzo della misura superiore/From the price of the larger size

<sup>3</sup> Contattare l'ufficio clienti per informazioni / Contact the customer service office for information

**DISPONIBILITA' A MAGAZZINO / STOCK AVAILABILITY**
**1/2** Settimane/Weeks

**+1** StarClean Optional

**2/3** Settimane/Weeks

**3/4** Settimane/Weeks

# POLARIS

PARETE FISSA  
FIXED PANEL



Per istruzioni di montaggio  
e ricambi inquadra il codice QR  
For assembly instructions  
and spare parts, scan the QR code



H. 195cm  
SP. 6mm

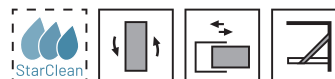

Parete fissa per abbinamenti. È possibile utilizzarla in abbinamento al modello di parete doccia selezionato per realizzare installazioni ad angolo o a tre lati quando possibile.

*Fixed panel for combinations. It can be used in combination with the selected shower enclosure model to create corner or three-sided installations where possible.*



## CONFIGURAZIONI IN ANGOLO ED A TRE LATI CORNER AND THREE-SIDED CONFIGURATIONS

È possibile realizzare configurazioni ad angolo ed a tre lati. Verificare le possibilità nelle pagine dei modelli specifici.

*It is possible to create corner and three-sided configurations; Check the options on the pages of the specific models.*

## ORIENTAMENTO E POSSIBILI COMBINAZIONI / ORIENTATION AND POSSIBLE CONFIGURATIONS

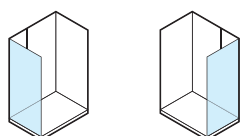

### PROFILI / PROFILES

STANDARD	
ULU	Brillantato Lucido Brilliant Polished
L91	Bianco Opaco Matte White
L96	Nero Opaco Matte Black

DOLCEVITA	
SNK	Nickel Spazzolato Nickel Brushed
AL4	Bronzo Spazzolato Brushed Bronze
AL5	Oro Rosa Lucido Polished Rose Gold
GLB	Oro Spazzolato Brushed Gold
GLP	Oro Lucido Polished Gold
GMB	Gun Metal Spazzolato Brushed Gun Metal

### VETRO / GLASS

STANDARD		
TR	Trasparente Transparent	
AS	Satinato Satin	
RF	Fascia H.100cm Band H.100cm	
ON DEMAND		
ST	Stampato Printed	TR +10%
TE	Extrachiario Extra Clear	TR +25%
TG	Trasparente Grigio Transparent Grey	TR +25%
GS	Satinato Grigio Satin Grey	TR +25%
SY	Specchio Mirror <sup>4</sup>	TR +50%

**PARETE FISSA / FIXED PANEL**

L1 NOM. [cm]	COD.	B [cm]	C [cm]	[dm <sup>3</sup> ]	[kg]	[n°]	V	ULU	L96	L91	DOLCEVITA
64-66,5	B3850	-	-	99	29	1	TR	490,00			635,00
							AS-RF	615,00		795,00	
66,5-69	B3851	-	-	101	29	1	TR	495,00			645,00
							AS-RF	620,00		805,00	
69-71,5	B3852	-	-	102	29	1	TR	500,00			650,00
							AS-RF	625,00		815,00	
71,5-74	B3853	-	-	112	29	1	TR	500,00			650,00
							AS-RF	625,00		815,00	
74-76,5	B3854	-	-	115	30	1	TR	505,00			655,00
							AS-RF	630,00		820,00	
76,5-79	B3855	-	-	117	31	1	TR	505,00			655,00
							AS-RF	630,00		820,00	
79-81,5	B3856	-	-	120	34	1	TR	510,00			665,00
							AS-RF	640,00		830,00	
81,5-84	B3857	-	-	137	35	1	TR	515,00			670,00
							AS-RF	645,00		840,00	
84-86,5	B3858	-	-	140	35	1	TR	520,00			675,00
							AS-RF	650,00		845,00	
86,5-89	B3860	-	-	143	35	1	TR	530,00			690,00
							AS-RF	665,00		865,00	
89-91,5	B3861	-	-	144	36	1	TR	530,00			690,00
							AS-RF	665,00		865,00	
96,5-99	B3862	-	-	156	37	1	TR	550,00			715,00
							AS-RF	690,00		895,00	
99-101,5	B3863	-	-	160	38	1	TR	570,00			740,00
							AS-RF	715,00		925,00	
106,5-109	B3864	-	-	162	39	1	TR	585,00			760,00
							AS-RF	730,00		950,00	
109-111,5	B3865	-	-	165	40	1	TR	605,00			785,00
							AS-RF	755,00		980,00	
116,5-119	B3866	-	-	168	41	1	TR	625,00			815,00
							AS-RF	780,00		1.020,00	
119-121,5	B3867	-	-	170	42	1	TR	645,00			840,00
							AS-RF	805,00		1.050,00	

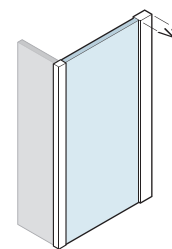

L1  
V2 42mm

SU MISURA/CUSTOM	PARETE FISSA FIXED PANEL	[€]
▲▼ Altezza/Height <sup>1</sup>	50-217cm	+20%
◀▶ Larghezza/Width <sup>2</sup>	15-160cm	+20%
◆ Altezza/Height Larghezza/Width <sup>2</sup>	50-217cm 15-160cm	+20%
Altre forme Other shapes <sup>2</sup>		+30%

OPTIONAL	COD.	[€]
 StarClean	Porta/Door	50,00

<sup>1</sup> Dal prezzo della misura di riferimento/From the price of selected size

<sup>2</sup> Dal prezzo della misura superiore/From the price of the larger size

DISPONIBILITA' A MAGAZZINO / STOCK AVAILABILITY

1/2 Settimane/Weeks

2/3 Settimane/Weeks

3/4 Settimane/Weeks

+1 StarClean Optional



# ALTER

## PRODOTTI DELLA SERIE / PRODUCTS OF THE SERIES

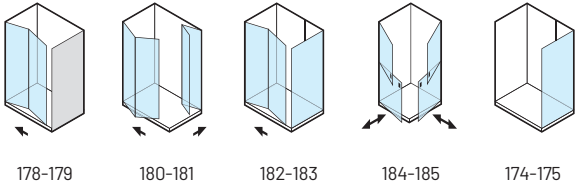

178-179

180-181

182-183

184-185

174-175

## PROFILI / PROFILES

### STANDARD



#### ULU

Brillantato Lucido  
Brilliant Polished

#### L91

Bianco Opaco  
Matte White

#### L96

Nero Opaco  
Matte Black

## VETRO / GLASS

### STANDARD



#### TR

Trasparente  
Transparent

### ON DEMAND



#### ST

Stampato  
Printed



#### TE

Extrachiaro  
Extra Clear



#### TG

Trasparente Grigio  
Transparent Grey



#### AS

Satinato  
Satin



#### GS

Satinato grigio  
Satin Grey



#### RF

Fascia H.100cm  
Band H.100cm



#### SY

Specchio  
Mirror

# ALTER

PORTA SOFFIETTO  
FOLDING DOOR



Per istruzioni di montaggio  
e ricambi inquadra il codice QR  
For assembly instructions  
and spare parts, scan the QR code



**H. 195cm**  
**SP. 6mm**

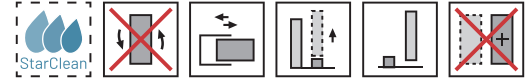

Parete doccia con due ante con apertura a soffietto. L'apertura delle ante è sia verso l'interno che verso l'esterno. Modello adatto per situazioni che necessitano di un ingresso ampio, ma con spazio di installazione limitato.

Shower enclosure with two folding doors. The doors open both inward and outward. A model suitable for situations requiring a wide entrance but with limited installation space.

### CONFIGURAZIONE IN NICCHIA NICHE CONFIGURATION

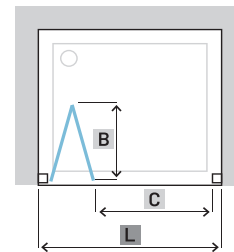

### CONFIGURAZIONI IN ANGOLO E A TRE LATI CORNER AND THREE-SIDED CONFIGURATIONS

Non è possibile realizzare configurazioni in angolo.  
Non è possibile realizzare configurazioni a tre lati.  
It is not possible to create corner configurations.  
It is not possible to create three-sided configurations.

### ORIENTAMENTO E POSSIBILI COMBINAZIONI / ORIENTATION AND POSSIBLE CONFIGURATIONS

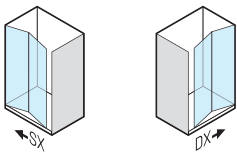

#### PROFILI / PROFILES

STANDARD	
ULU	Brillantato Lucido Brilliant Polished
L91	Bianco Opaco Matte White
L96	Nero Opaco Matte Black

#### VETRO/GLASS

STANDARD	
TR	Trasparente Transparent

ON DEMAND		
ST	Stampato Printed	TR +10%
TE	Extrachiaro Extra Clear	TR +25%
TG	Trasparente Grigio Transparent Grey	TR +25%
AS	Satinato Satin	TR +25%
GS	Satinato Grigio Satin Grey	TR +25%
RF	Fascia H.100cm Band H.100cm	TR +25%
SY	Specchio Mirror <sup>3</sup>	TR +50%

## PORTA / DOOR

L [cm]	COD.	B [cm]	C [cm]	[dm <sup>3</sup> ]	[kg]	[n°]	V	ULU	L96	L91
66-69	<b>B9541</b>	29,6	54	63	25	1	TR		800,00	
69,5-72,5	<b>B9542</b>	31,6	58	66	27	1	TR		810,00	
73-76	<b>B9543</b>	33,6	61	68	28	1	TR		820,00	
76,5-79,5	<b>B9544</b>	35,6	65	70	29	1	TR		830,00	
80-83	<b>B9545</b>	36,6	68	73	30	1	TR		840,00	
83,5-86,5	<b>B9546</b>	38,6	72	76	31	1	TR		850,00	
87-90	<b>B9547</b>	40,6	75	79	32	1	TR		855,00	
90,5-93,5	<b>B9548</b>	42,6	79	80	33	1	TR		865,00	

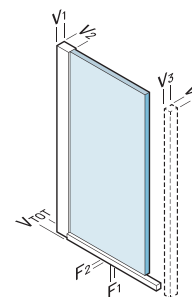

L	
V <sub>1</sub>	31mm
V <sub>2</sub>	38mm
V <sub>3</sub>	24mm
V <sub>4</sub>	23mm
V <sub>TOT</sub>	35mm
F <sub>1</sub>	9mm
F <sub>2</sub>	9mm

SU MISURA/CUSTOM	PORTA DOOR	[€]
↕ Altezza/Height <sup>1</sup>	100-217cm	+20%
↔ Larghezza/Width <sup>2</sup>	45-120cm	+20%
↕ Altezza/Height ↔ Larghezza/Width <sup>2</sup>	100-217cm 45-120cm	+20%
Altre forme Other shapes <sup>2</sup>		+30%

OPTIONAL	COD.	[€]
 StarClean	Porta/Door	50,00

<sup>1</sup> Dal prezzo della misura di riferimento / From the price of selected size

<sup>2</sup> Dal prezzo della misura superiore / From the price of the larger size

<sup>3</sup> Contattare l'ufficio clienti per informazioni / Contact the customer service office for information

### DISPONIBILITA' A MAGAZZINO / STOCK AVAILABILITY

1/2 Settimane/Weeks  
+1 StarClean Optional

2/3 Settimane/Weeks

3/4 Settimane/Weeks

# ALTER

PORTA SOFFIETTO + PORTA SOFFIETTO  
FOLDING DOOR + FOLDING DOOR



Per istruzioni di montaggio  
e ricambi inquadra il codice QR  
For assembly instructions  
and spare parts, scan the QR code



H. 195cm  
SP. 6mm

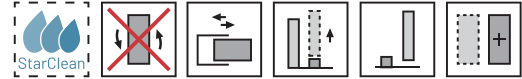

Parete doccia in configurazione ad angolo formata da due porte con apertura a soffietto. L'apertura delle ante è sia verso l'interno che verso l'esterno. Modello adatto per situazioni che necessitano di un ingresso ampio, ma con spazio di installazione limitato.

Corner shower enclosure configuration consisting of two doors with a folding opening. The doors open both inward and outward. A model suitable for situations requiring a wide entrance but with limited installation space.

### CONFIGURAZIONE AD ANGOLO CORNER CONFIGURATION

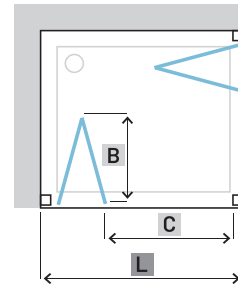

### ! CONFIGURAZIONI IN NICCHIA E A TRE LATI NICHE AND THREE-SIDED CONFIGURATIONS

Non è possibile realizzare configurazioni in nicchia.  
Non è possibile realizzare configurazioni a tre lati.  
It is not possible to create niche configurations.  
It is not possible to create three-sided configurations.

### ORIENTAMENTO E POSSIBILI COMBINAZIONI / ORIENTATION AND POSSIBLE CONFIGURATIONS

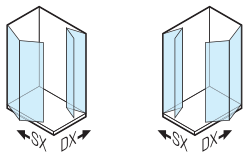

#### PROFILI / PROFILES

STANDARD	
ULU	Brillantato Lucido Brilliant Polished
L91	Bianco Opaco Matte White
L96	Nero Opaco Matte Black

#### VETRO/GLASS

STANDARD	
TR	Trasparente Transparent

ON DEMAND		
ST	Stampato Printed	TR +10%
TE	Extrachiario Extra Clear	TR +25%
TG	Trasparente Grigio Transparent Grey	TR +25%
AS	Satinato Satin	TR +25%
GS	Satinato Grigio Satin Grey	TR +25%
RF	Fascia H.100cm Band H.100cm	TR +25%
SY	Specchio Mirror <sup>4</sup>	TR +50%

## PORTA / DOOR

L [cm]	COD.	L NOM. [cm]	B [cm]	C [cm]	[dm3]	[kg]	[n°]	V	ULU	L96	L91
67,8-69,8	B9520	66-68	30,6	75	102	24	1	TR		645,00	
69,8-71,8	B9521	68-70	31,6	78	106	24	1	TR		650,00	
71,8-73,8	B9522	70-72	32,6	81	108	24	1	TR		660,00	
73,8-75,8	B9523	72-74	33,6	84	110	24	1	TR		665,00	
75,8-77,8	B9524	74-76	34,6	87	115	25	1	TR		675,00	
77,8-79,8	B9525	76-78	35,6	90	118	26	1	TR		685,00	
79,8-81,8	B9526	78-80	36,6	93	121	28	1	TR		695,00	
81,8-83,8	B9527	80-82	37,6	96	122	29	1	TR		700,00	
83,8-85,8	B9528	82-84	38,6	99	125	30	1	TR		710,00	
85,8-87,8	B9529	84-86	39,6	102	126	31	1	TR		715,00	
87,8-89,8	B9530	86-88	40,6	105	127	32	1	TR		725,00	
89,8-91,8	B9531	88-90	41,6	108	131	33	1	TR		730,00	
91,8-93,8	B9532	90-92	42,6	111	133	34	1	TR		740,00	
93,8-95,8	B9533	92-94	43,6	114	136	35	1	TR		750,00	
95,8-97,8	B9534	94-96	44,6	117	139	37	1	TR		755,00	
97,8-99,8	B9535	96-98	45,6	120	142	38	1	TR		765,00	
99,8-101,8	B9536	98-100	46,6	123	144	39	1	TR		770,00	

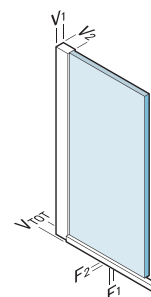

L	
V <sub>1</sub>	31mm
V <sub>2</sub>	38mm
V <sub>TOT</sub>	35mm
F <sub>1</sub>	9mm
F <sub>2</sub>	9mm

**I** I valori della tabella prezzi si riferiscono ad un singolo lato: sommare l'importo dei due codici della misura desiderata per ottenere il prezzo totale di una doccia ad angolo quadrata o rettangolare. Apertura (C) determinata con due lati della stessa misura. Specificare il verso di apertura della parete doccia (/SX o /DX)

The prices in the table refer to a single side: add the amounts of the two codes for the desired size to get the total price of a square or rectangular corner shower. Opening (C) is determined by two sides of the same size. Specify the opening direction of the shower enclosure (/SX or /DX).

SU MISURA/CUSTOM	PORTA DOOR	[€]
↕ Altezza/Height <sup>1</sup>	100-217cm	+20%
↔ Larghezza/Width <sup>2</sup>	45-120cm	+20%
↕ Altezza/Height ↔ Larghezza/Width <sup>2</sup>	100-217cm 45-120cm	+20%
Altre forme Other shapes <sup>2</sup>		+30%

OPTIONAL	COD.	[€]
 StarClean	Porta/Door	50,00

<sup>1</sup> Dal prezzo della misura di riferimento / From the price of selected size

<sup>2</sup> Dal prezzo della misura superiore / From the price of the larger size

<sup>3</sup> Contattare l'ufficio clienti per informazioni / Contact the customer service office for information

DISPONIBILITA' A MAGAZZINO / STOCK AVAILABILITY

1/2 Settimane/Weeks

2/3 Settimane/Weeks

3/4 Settimane/Weeks

+1 StarClean Optional

# ALTER

PORTA SOFFIETTO + PARETE FISSA  
FOLDING DOOR + FIXED PANEL



Per istruzioni di montaggio  
e ricambi inquadra il codice QR  
For assembly instructions  
and spare parts, scan the QR code



H. 195cm  
SP. 6mm

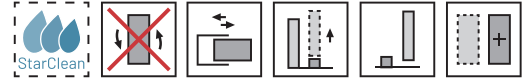

Parete doccia in configurazione ad angolo formata da una porta a soffietto più parete fissa. L'apertura delle ante è sia verso l'interno che verso l'esterno. Modello adatto per situazioni che necessitano di un ingresso ampio, ma con spazio di installazione limitato.

Corner shower enclosure configuration consisting of a folding door and a fixed panel. The door opens both inward and outward. A model suitable for situations requiring a wide entrance but with limited installation space.

### CONFIGURAZIONE AD ANGOLO CORNER CONFIGURATION

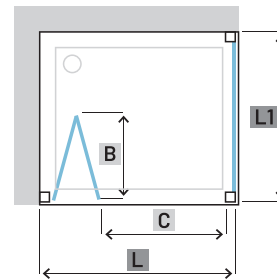

### CONFIGURAZIONI IN NICCHIA E A TRE LATI NICHE AND THREE-SIDED CONFIGURATIONS

Non è possibile realizzare configurazioni in nicchia.  
Non è possibile realizzare configurazioni a tre lati.  
It is not possible to create niche configurations.  
It is not possible to create three-sided configurations.

### ORIENTAMENTO E POSSIBILI COMBINAZIONI / ORIENTATION AND POSSIBLE CONFIGURATIONS

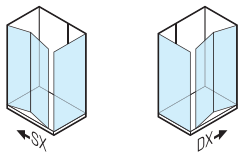

#### PROFILI / PROFILES

STANDARD	
ULU	Brillantato Lucido Brilliant Polished
L91	Bianco Opaco Matte White
L96	Nero Opaco Matte Black

#### VETRO/GLASS

STANDARD	
TR	Trasparente Transparent

ON DEMAND		
ST	Stampato Printed	TR +10%
TE	Extrachiaro Extra Clear	TR +25%
TG	Trasparente Grigio Transparent Grey	TR +25%
AS	Satinato Satin	TR +25%
GS	Satinato Grigio Satin Grey	TR +25%
RF	Fascia H.100cm Band H.100cm	TR +25%
SY	Specchio Mirror <sup>4</sup>	TR +50%

## PORTA / DOOR

L [cm]	COD.	L NOM. [cm]	B [cm]	C [cm]	[dm3]	[kg]	[n°]	V	ULU	L96	L91
67,3-69,3	B9520	66-68	30,6	75	102	24	1	TR		645,00	
69,3-71,3	B9521	68-70	31,6	78	106	24	1	TR		650,00	
71,3-73,3	B9522	70-72	32,6	81	108	24	1	TR		660,00	
73,3-75,3	B9523	72-74	33,6	84	110	24	1	TR		665,00	
75,3-77,3	B9524	74-76	34,6	87	115	25	1	TR		675,00	
77,3-79,3	B9525	76-78	35,6	90	118	26	1	TR		685,00	
79,3-81,3	B9526	78-80	36,6	93	121	28	1	TR		695,00	
81,3-83,3	B9527	80-82	37,6	96	122	29	1	TR		700,00	
83,3-85,3	B9528	82-84	38,6	99	125	30	1	TR		710,00	
85,3-87,3	B9529	84-86	39,6	102	126	31	1	TR		715,00	
87,3-89,3	B9530	86-88	40,6	105	127	32	1	TR		725,00	
89,3-91,3	B9531	88-90	41,6	108	131	33	1	TR		730,00	
91,3-93,3	B9532	90-92	42,6	111	133	34	1	TR		740,00	
93,3-95,3	B9533	92-94	43,6	114	136	35	1	TR		750,00	
95,3-97,3	B9534	94-96	44,6	117	139	37	1	TR		755,00	
97,3-99,3	B9535	96-98	45,6	120	142	38	1	TR		765,00	
99,3-101,3	B9536	98-100	46,6	123	144	39	1	TR		770,00	

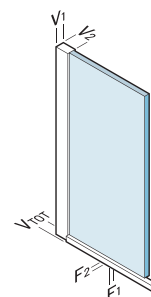

L	
V <sub>1</sub>	31mm
V <sub>2</sub>	38mm
V <sub>TOT</sub>	35mm
F <sub>1</sub>	9mm
F <sub>2</sub>	9mm

## PARETE FISSA / FIXED PANEL

H. 195cm  
SP. 6mm

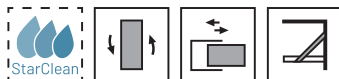

L1 [cm]	COD.	L1 NOM. [cm]	B [cm]	C [cm]	[dm3]	[kg]	[n°]	V	ULU	L96	L91
65,8-68,3	B3850	64-66,5	-	-	99	29	1	TR		490,00	
68,3-70,8	B3851	66,5-69	-	-	101	29	1	TR		495,00	
70,8-73,3	B3852	69-71,5	-	-	102	29	1	TR		500,00	
73,3-75,8	B3853	71,5-74	-	-	112	29	1	TR		500,00	
75,8-78,3	B3854	74-76,5	-	-	115	30	1	TR		505,00	
78,3-80,8	B3855	76,5-79	-	-	117	31	1	TR		505,00	
80,8-83,3	B3856	79-81,5	-	-	120	34	1	TR		510,00	
83,3-85,8	B3857	81,5-84	-	-	137	35	1	TR		515,00	
85,8-88,3	B3858	84-86,5	-	-	140	35	1	TR		520,00	
88,3-90,8	B3860	86,5-89	-	-	143	35	1	TR		530,00	
90,8-93,3	B3861	89-91,5	-	-	144	36	1	TR		530,00	
98,3-100,8	B3862	96,5-99	-	-	156	37	1	TR		550,00	
100,8-103,3	B3863	99-101,5	-	-	160	38	1	TR		570,00	
108,3-110,8	B3864	106,5-109	-	-	162	39	1	TR		585,00	
110,8-113,3	B3865	109-111,5	-	-	165	40	1	TR		605,00	
118,3-120,8	B3866	116,5-119	-	-	168	41	1	TR		625,00	
120,8-123,3	B3867	119-121,5	-	-	170	42	1	TR		645,00	

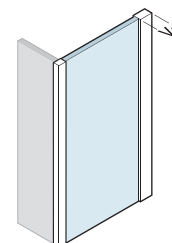

L1	
V <sub>2</sub>	42mm

SU MISURA/CUSTOM	PORTA DOOR	[€]	PARETE FISSA FIXED PANEL	[€]
↕ Altezza/Height <sup>1</sup>	100-217cm	+20%	50-217cm	+20%
↔ Larghezza/Width <sup>2</sup>	45-120cm	+20%	15-160cm	+20%
↕ Altezza/Height ↔ Larghezza/Width <sup>2</sup>	100-217cm 45-120cm	+20%	50-217cm 15-160cm	+20%
Altre forme Other shapes <sup>2</sup>		+30%		+30%

OPTIONAL	COD.	[€]
StarClean	Porta/Door	50,00
	Parete Fissa/Fixed Panel	50,00

<sup>1</sup> Dal prezzo della misura di riferimento / From the price of selected size

<sup>2</sup> Dal prezzo della misura superiore / From the price of the larger size

<sup>3</sup> Contattare l'ufficio clienti per informazioni / Contact the customer service office for information

DISPONIBILITA' A MAGAZZINO / STOCK AVAILABILITY

1/2 Settimane/Weeks

2/3 Settimane/Weeks

3/4 Settimane/Weeks

+1 StarClean Optional

# ALTER

PORTA BATTENTE DIVISIBILE + PORTA BATTENTE DIVISIBILE  
SPLIT HINGED DOOR + SPLIT HINGED DOOR



Per istruzioni di montaggio  
e ricambi inquadra il codice QR  
For assembly instructions  
and spare parts, scan the QR code



H. 190cm  
SP. 6mm

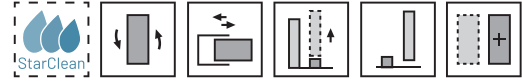

Parete doccia in configurazione ad angolo formata da due porte battenti sezionabili. L'apertura dell'anta è sia verso l'interno che verso l'esterno. Modello adatto per situazioni che necessitano della massima apertura possibile.

Corner shower enclosure configuration consisting of two sectional hinged doors. The doors open both inward and outward. A model suitable for situations requiring the maximum possible opening.

### CONFIGURAZIONE AD ANGOLO CORNER CONFIGURATION

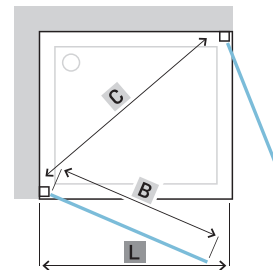

### CONFIGURAZIONI IN NICCHIA E A TRE LATI NICHE AND THREE-SIDED CONFIGURATIONS

Non è possibile realizzare configurazioni in nicchia.  
Non è possibile realizzare configurazioni a tre lati.  
It is not possible to create niche configurations.  
It is not possible to create three-sided configurations.

### ORIENTAMENTO E POSSIBILI COMBINAZIONI / ORIENTATION AND POSSIBLE CONFIGURATIONS

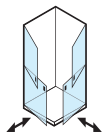

#### PROFILI / PROFILES

STANDARD	
ULU	Brillantato Lucido Brilliant Polished
L91	Bianco Opaco Matte White
L96	Nero Opaco Matte Black

#### VETRO/GLASS

STANDARD	
TR	Trasparente Transparent

ON DEMAND		
ST	Stampato Printed	TR +10%
TE	Extrachiaro Extra Clear	TR +25%
TG	Trasparente Grigio Transparent Grey	TR +25%
AS	Satinato Satin	TR +25%
GS	Satinato Grigio Satin Grey	TR +25%
RF	Fascia H.100cm Band H.100cm	TR +25%
SY	Specchio Mirror <sup>4</sup>	TR +50%

## PORTA / DOOR

L [cm]	COD.	L NOM. [cm]	B [cm]	C [cm]	[dm3]	[kg]	[n°]	V	ULU	L96	L91
67,1-69,1	<b>B9501</b>	66-68	60	84	108	24	1	TR		850,00	
69,1-71,1	<b>B9502</b>	68-70	62	87	109	24	1	TR		855,00	
71,1-73,1	<b>B9503</b>	70-72	64	89	112	24	1	TR		860,00	
73,1-75,1	<b>B9504</b>	72-74	66	92	115	24	1	TR		870,00	
75,1-77,1	<b>B9505</b>	74-76	68	95	122	25	1	TR		870,00	
77,1-79,1	<b>B9506</b>	76-78	70	98	125	26	1	TR		875,00	
79,1-81,1	<b>B9507</b>	78-80	72	101	128	28	1	TR		880,00	
81,1-83,1	<b>B9508</b>	80-82	74	103	134	29	1	TR		885,00	
83,1-85,1	<b>B9509</b>	82-84	76	106	134	30	1	TR		890,00	
85,1-87,1	<b>B9510</b>	84-86	78	109	137	31	1	TR		895,00	
87,1-89,1	<b>B9511</b>	86-88	80	112	140	32	1	TR		900,00	
89,1-91,1	<b>B9512</b>	88-90	82	115	143	33	1	TR		905,00	
91,1-93,1	<b>B9513</b>	90-92	84	118	146	34	1	TR		910,00	
93,1-95,1	<b>B9514</b>	92-94	86	120	149	35	1	TR		915,00	
95,1-97,1	<b>B9515</b>	94-96	88	123	152	37	1	TR		920,00	
97,1-99,1	<b>B9516</b>	96-98	90	126	155	38	1	TR		925,00	
99,1-101,1	<b>B9517</b>	98-100	92	128	158	39	1	TR		930,00	

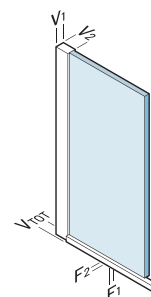

L	
V <sub>1</sub>	38mm
V <sub>2</sub>	62mm
V <sub>TOT</sub>	38mm
F <sub>1</sub>	9mm
F <sub>2</sub>	9mm

**I** I valori della tabella prezzi si riferiscono ad un singolo lato: sommare l'importo dei due codici della misura desiderata per ottenere il prezzo totale di una doccia ad angolo quadrata o rettangolare. Apertura (C) determinata con due lati della stessa misura. Specificare il verso di apertura della parete doccia (/SX o /DX)  
*The prices in the table refer to a single side: add the amounts of the two codes for the desired size to get the total price of a square or rectangular corner shower. Opening (C) is determined by two sides of the same size. Specify the opening direction of the shower enclosure (/SX or /DX).*

SU MISURA/CUSTOM	PORTA DOOR	[€]
↕ Altezza/Height <sup>1</sup>	217cm	+20%
↔ Larghezza/Width <sup>2</sup>	60-110cm	+20%
↕ Altezza/Height ↔ Larghezza/Width <sup>2</sup>	217cm 60-110cm	+20%
Altre forme Other shapes <sup>2</sup>		+30%

OPTIONAL	COD.	[€]
 StarClean	Porta/Door	50,00

<sup>1</sup> Dal prezzo della misura di riferimento / From the price of selected size

<sup>2</sup> Dal prezzo della misura superiore / From the price of the larger size

<sup>3</sup> Contattare l'ufficio clienti per informazioni / Contact the customer service office for information

DISPONIBILITA' A MAGAZZINO / STOCK AVAILABILITY

1/2 Settimane/Weeks

2/3 Settimane/Weeks

3/4 Settimane/Weeks

+1 StarClean Optional

# GRAND POLARIS





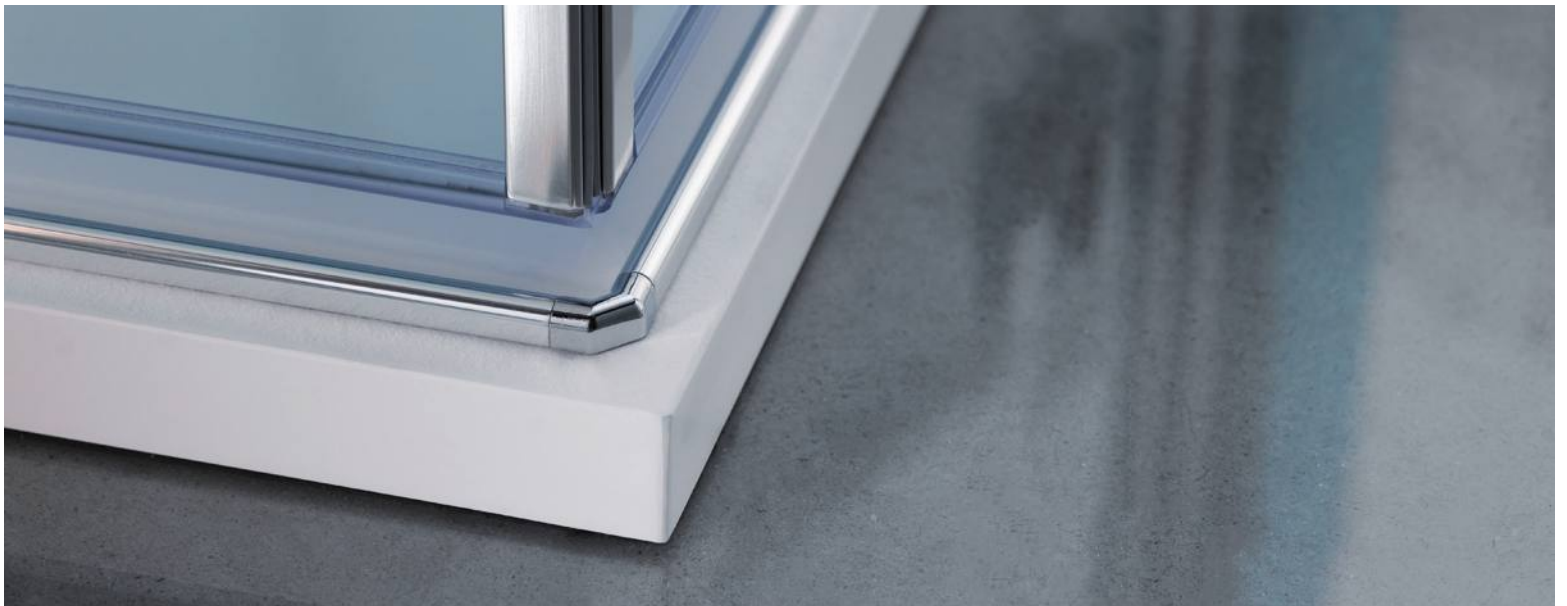
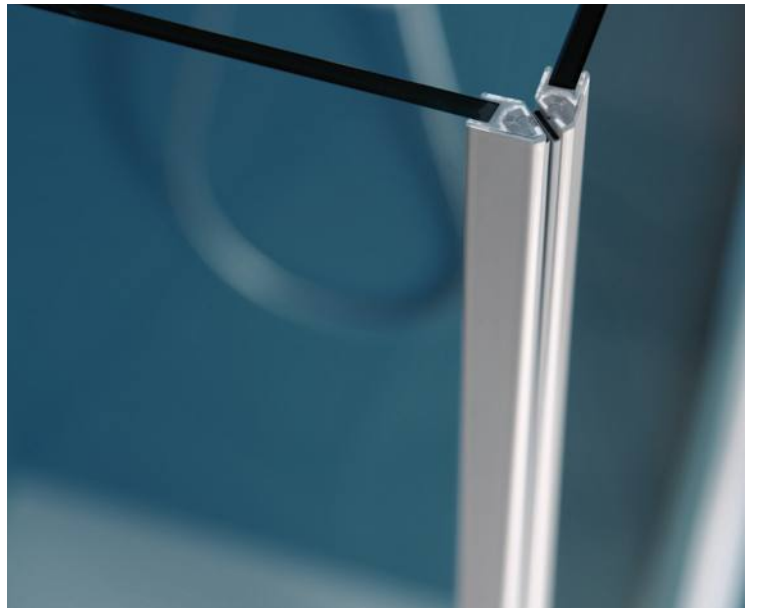





- > Parete doccia senza telaio
- > Vetro temperato 6mm per tutta la gamma
- > Trattamento anticalcare StarClean di serie incluso nel prezzo
- > Estensibilità e regolazione fuori squadra del muro fino a 2,5cm
- > Interasse maniglia 160mm
- > Cerniere a filo interno apribili a 180° verso l'esterno con sollevamento dell'anta
- > Stampa digitale disponibile su tutti i vetri piani TR

- > *Frameless shower enclosure*
- > *6mm tempered glass across the entire range*
- > *StarClean anti-limescale treatment included in the price*
- > *Wall adjustment and out-of-square compensation up to 2,5cm*
- > *Handle centre-to-centre distance 160mm*
- > *Flush internal hinges that open 180° outward, lifting the door panel.*
- > *Digital printing available on all flat glasses TR*

# GRAND POLARIS

## PRODOTTI DELLA SERIE / PRODUCTS OF THE SERIES

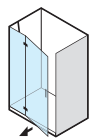

192-193

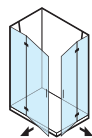

194-195

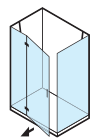

196-197

## PROFILI / PROFILES

### STANDARD



**ULU**  
Brillantato Lucido  
*Brilliant Polished*

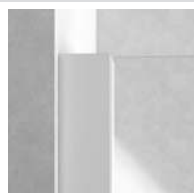

**L91**  
Bianco Opaco  
*Matte White*



**L96**  
Nero Opaco  
*Matte Black*

## VETRO / GLASS

### STANDARD



**TR**  
Trasparente  
*Transparent*



**AS**  
Satinato  
*Satin*



**RF**  
Fascia H.100cm  
*Band H.100cm*

### ON DEMAND



**ST**  
Stampato  
*Printed*



**TE**  
Extrachiaro  
*Extra Clear*



**TG**  
Trasparente Grigio  
*Transparent Grey*



**GS**  
Satinato grigio  
*Satin Grey*



**SY**  
Specchio  
*Mirror*

# GRAND POLARIS

PORTA BATTENTE CON FISSO IN LINEA  
HINGED DOOR WITH INLINE FIXED PANEL



Per istruzioni di montaggio  
e ricambi inquadra il codice QR  
For assembly instructions  
and spare parts, scan the QR code



H. 195cm  
SP. 6mm

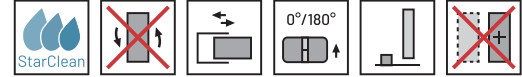

Parete doccia con apertura a porta battente con parete fissa in linea.  
L'apertura dell'anta è verso l'esterno. Modello ad alto impatto estetico e  
disponibile in dimensioni maggiori rispetto ad una tradizionale porta.

Shower enclosure with a hinged door opening and an inline fixed panel.  
The door opens outward. This model has a high aesthetic impact and is  
available in larger dimensions compared to a traditional door.

## CONFIGURAZIONE IN NICCHIA NICHE CONFIGURATION

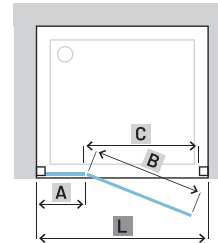

## CONFIGURAZIONI IN ANGOLO E A TRE LATI CORNER AND THREE-SIDED CONFIGURATIONS

Non è possibile realizzare configurazioni in angolo.  
Non è possibile realizzare configurazioni a tre lati.  
It is not possible to create corner configurations.  
It is not possible to create three-sided configurations.

## ORIENTAMENTO E POSSIBILI COMBINAZIONI / ORIENTATION AND POSSIBLE CONFIGURATIONS

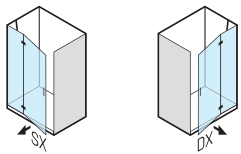

### PROFILI / PROFILES

STANDARD	
ULU	Brillantato Lucido Brilliant Polished
L91	Bianco Opaco Matte White
L96	Nero Opaco Matte Black

### VETRO / GLASS

STANDARD	
TR	Trasparente Transparent
AS	Satinato Satin
RF	Fascia H.100cm Band H.100cm

ON DEMAND		
ST	Stampato Printed	TR +10%
TE	Extrachiaro Extra Clear	TR +25%
TG	Trasparente Grigio Transparent Grey	TR +25%
GS	Satinato Grigio Satin Grey	TR +25%
SY	Specchio Mirror <sup>3</sup>	TR +50%

**PORTA / DOOR**

L [cm]	COD.	A [cm]	B [cm]	C [cm]	[dm <sup>3</sup> ]	[kg]	[n°]	V	L96 L91	
									ULU	
62-65,5	B3730	19,8-22,3	39,9	39	70	26	1	TR	715,00	
								AS-RF	895,00	
65,5-69	B3731	23,3-25,8	39,9	39	76	27,5	1	TR	725,00	
								AS-RF	905,00	
69-72,5	B3732	23,3-25,8	43,4	42	76	29	1	TR	735,00	
								AS-RF	920,00	
72,5-76	B3733	26,8-29,3	43,4	42	82	29,5	1	TR	740,00	
								AS-RF	925,00	
76-79,5	B3734	26,8-29,3	46,9	46	84	30	1	TR	750,00	
								AS-RF	940,00	
79,5-83	B3735	30,3-32,8	46,9	46	84	30,5	1	TR	755,00	
								AS-RF	945,00	
83-86,5	B3736	30,3-32,8	50,4	49	89	31	1	TR	765,00	
								AS-RF	945,00	
86,5-90	B3737	33,3-35,8	50,9	49	89	32,5	1	TR	765,00	
								AS-RF	955,00	
90-93,5	B3738	33,3-35,8	54,5	53	95	34	1	TR	770,00	
								AS-RF	965,00	
93,5-97	B3739	37,3-39,8	53,9	53	99	35	1	TR	780,00	
								AS-RF	975,00	
97-100,5	B3740	37,3-39,8	57,4	56	105	36	1	TR	785,00	
								AS-RF	980,00	
100,5-104	B3741	40,8-43,3	57,4	56	111	36,5	1	TR	795,00	
								AS-RF	995,00	
104-107,5	B3742	40,8-43,3	60,9	60	111	37,5	1	TR	795,00	
								AS-RF	995,00	
107,5-111	B3743	40,8-43,3	64,4	63	111	38	1	TR	805,00	
								AS-RF	1.005,00	
111-114,5	B3744	43,3-46,8	64,4	63	111	36	1	TR	810,00	
								AS-RF	1.015,00	
114,5-118	B3745	47,2-49,7	65	64	115	40	1	TR	820,00	
								AS-RF	1.025,00	
118-121,5	B3746	47,2-49,7	68,5	67	119	42	1	TR	825,00	
								AS-RF	1.030,00	

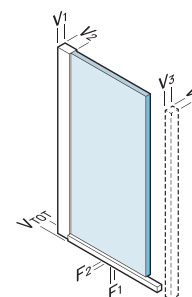

L	
V <sub>1</sub>	45mm
V <sub>2</sub>	42mm
V <sub>3</sub>	23mm
V <sub>4</sub>	21mm
V <sub>TOT</sub>	48mm
F <sub>1</sub>	10mm
F <sub>2</sub>	10mm

SU MISURA/CUSTOM	PORTA DOOR	[€]
▲▼ Altezza/Height <sup>1</sup>	150-217cm	+20%
◄► Larghezza/Width <sup>2</sup>	60-140cm	+20%
◆ Altezza/Height Larghezza/Width <sup>2</sup>	150-217cm 60-140cm	+20%
Altre forme Other shapes <sup>2</sup>		+30%

OPTIONAL	COD.	[€]
Profilo di compensazione Compensation Profile	COM50A (+2cm)	ULU L91-L96
		65,00 65,00

<sup>1</sup> Dal prezzo della misura di riferimento/From the price of selected size

<sup>2</sup> Dal prezzo della misura superiore/From the price of the larger size

<sup>3</sup> Contattare l'ufficio clienti per informazioni / Contact the customer service office for information

DISPONIBILITA' A MAGAZZINO / STOCK AVAILABILITY

1/2 Settimane/Weeks

2/3 Settimane/Weeks

3/4 Settimane/Weeks

# GRAND POLARIS

ANGOLO DOPPIA PORTA BATTENTE CON FISSO IN LINEA  
DOUBLE CORNER HINGED DOOR WITH FIXED PANEL IN LINE



Per istruzioni di montaggio  
e ricambi inquadra il codice QR  
For assembly instructions  
and spare parts, scan the QR code



H. 195cm  
SP. 6mm

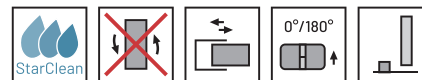

Parete doccia in configurazione ad angolo formata da due porte battenti con parete fissa in linea. L'apertura dell'anta è verso l'esterno. Modello ad alto impatto estetico e disponibile in dimensioni maggiori rispetto ad una tradizionale porta.

Corner shower enclosure configuration consisting of two hinged doors with an inline fixed panel. The doors open outward. This model has a high aesthetic impact and is available in larger dimensions compared to a traditional door.

## CONFIGURAZIONE AD ANGOLO CORNER CONFIGURATION

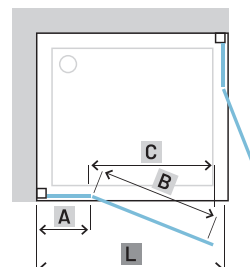

### ! CONFIGURAZIONI IN NICCHIA E A TRE LATI NICHE AND THREE-SIDED CONFIGURATIONS

Non è possibile realizzare configurazioni in nicchia.  
Non è possibile realizzare configurazioni a tre lati.  
It is not possible to create niche configurations.  
It is not possible to create three-sided configurations.

## ORIENTAMENTO E POSSIBILI COMBINAZIONI / ORIENTATION AND POSSIBLE CONFIGURATIONS

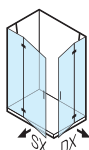

### PROFILI / PROFILES

STANDARD	
ULU	Brillantato Lucido Brilliant Polished
L91	Bianco Opaco Matte White
L96	Nero Opaco Matte Black

### VETRO / GLASS

STANDARD	
TR	Trasparente Transparent
AS	Satinato Satin
RF	Fascia H.100cm Band H.100cm

### ON DEMAND

ST	Stampato Printed	TR +10%
TE	Extrachiaro Extra Clear	TR +25%
TG	Trasparente Grigio Transparent Grey	TR +25%
GS	Satinato Grigio Satin Grey	TR +25%
SY	Specchio Mirror <sup>3</sup>	TR +50%

**PORTA / DOOR**

L [cm]	COD.	L NOM. [cm]	A [cm]	B [cm]	C [cm]	[dm <sup>3</sup> ]	[kg]	[n°]	V	ULU	L96 L91
66,6-69,1	<b>B3705</b>	65-67,5	23,3-25,8	41,7	56	73	26	1	TR	700,00	
									AS-RF	875,00	
69,1-71,6	<b>B3706</b>	67,5-70	23,3-25,8	44,2	60	76	26,5	1	TR	705,00	
									AS-RF	880,00	
72,1-74,6	<b>B3707</b>	70,5-73	24,8-27,3	45,7	62	74	27,5	1	TR	715,00	
									AS-RF	895,00	
74,6-77,1	<b>B3708</b>	73-75,5	24,8-27,3	45,7	62	80	28,5	1	TR	720,00	
									AS-RF	900,00	
78,1-80,6	<b>B3709</b>	76,5-79	27,3-29,8	51,7	70	85	29	1	TR	725,00	
									AS-RF	905,00	
80,6-83,1	<b>B3710</b>	79-81,5	27,3-29,8	51,7	70	84	30	1	TR	730,00	
									AS-RF	915,00	
83,6-86,1	<b>B3711</b>	82-84,5	30,3-32,8	51,7	70	83	30,5	1	TR	735,00	
									AS-RF	920,00	
86,6-89,1	<b>B3712</b>	85-87,5	33,3-35,8	51,7	70	89	31	1	TR	740,00	
									AS-RF	925,00	
96,6-99,1	<b>B3713</b>	95-97,5	37,3-39,8	57,7	79	99	34	1	TR	750,00	
									AS-RF	940,00	
106,6-109,1	<b>B3714</b>	105-107,5	47,2-49,7	57,7	79	99	37	1	TR	765,00	
									AS-RF	955,00	
116,6-119,1	<b>B3715</b>	115-117,5	57,3-59,8	57,7	79	114	39	1	TR	775,00	
									AS-RF	970,00	

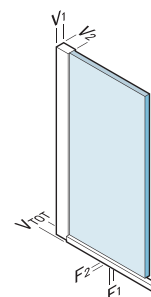

L	
V <sub>1</sub>	45mm
V <sub>2</sub>	42mm
V <sub>TOT</sub>	48mm
F <sub>1</sub>	10mm
F <sub>2</sub>	10mm

**I** I valori della tabella prezzi si riferiscono ad un singolo lato: sommare l'importo dei due codici della misura desiderata per ottenere il prezzo totale di una doccia ad angolo quadrata o rettangolare. Apertura (C) determinata con due lati della stessa misura. Specificare il verso di apertura della parete doccia (/SX o /DX).  
 The prices in the table refer to a single side: add the amounts of the two codes for the desired size to get the total price of a square or rectangular corner shower. Opening (C) is determined by two sides of the same size. Specify the opening direction of the shower enclosure (/SX or /DX).

SU MISURA/CUSTOM	PORTA DOOR	[€]
▲▼ Altezza/Height <sup>1</sup>	150-217cm	+20%
◀▶ Larghezza/Width <sup>2</sup>	50-120cm	+20%
◆ Altezza/Height Larghezza/Width <sup>2</sup>	150-217cm 50-120cm	+20%
Altre forme Other shapes <sup>2</sup>		+30%

OPTIONAL	COD.	[€]
Profilo di compensazione Compensation Profile	<b>COM50A</b> ULU (+2cm) L91-L96	65,00 65,00

<sup>1</sup> Dal prezzo della misura di riferimento/From the price of selected size

<sup>2</sup> Dal prezzo della misura superiore/From the price of the larger size

<sup>3</sup> Contattare l'ufficio clienti per informazioni / Contact the customer service office for information

DISPONIBILITA' A MAGAZZINO / STOCK AVAILABILITY

1/2 Settimane/Weeks

2/3 Settimane/Weeks

3/4 Settimane/Weeks

# GRAND POLARIS

PORTA BATTENTE CON FISSO IN LINEA + PARETE FISSA DEDICATA  
HINGED DOOR WITH INLINE FIXED PANEL + DEDICATED FIXED PANEL



Per istruzioni di montaggio  
e ricambi inquadra il codice QR  
For assembly instructions  
and spare parts, scan the QR code



H. 195cm  
SP. 6mm

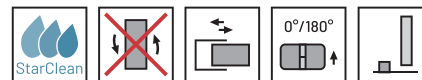

Parete doccia in configurazione ad angolo formata da porta battente con parete fissa in linea più parete fissa. L'apertura dell'anta è verso l'esterno. Modello ad alto impatto estetico e disponibile in dimensioni maggiori rispetto ad una tradizionale porta.

Corner shower enclosure configuration consisting of a hinged door with an inline fixed panel and an additional fixed panel. The door opens outward. A model with a high aesthetic impact, available in larger sizes compared to a traditional door.

## CONFIGURAZIONE AD ANGOLO CORNER CONFIGURATION

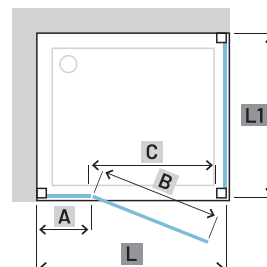

### ! CONFIGURAZIONI IN NICCHIA E A TRE LATI NICHE AND THREE-SIDED CONFIGURATIONS

Non è possibile realizzare configurazioni in nicchia.  
Non è possibile realizzare configurazioni a tre lati.  
It is not possible to create niche configurations.  
It is not possible to create three-sided configurations.

## ORIENTAMENTO E POSSIBILI COMBINAZIONI / ORIENTATION AND POSSIBLE CONFIGURATIONS

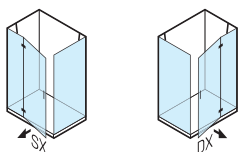

### PROFILI / PROFILES

STANDARD	
ULU	Brillantato Lucido Brilliant Polished
L91	Bianco Opaco Matte White
L96	Nero Opaco Matte Black

### VETRO / GLASS

STANDARD	
TR	Trasparente Transparent
AS	Satinato Satin
RF	Fascia H.100cm Band H.100cm

### ON DEMAND

ST	Stampato Printed	TR +10%
TE	Extrachiaro Extra Clear	TR +25%
TG	Trasparente Grigio Transparent Grey	TR +25%
GS	Satinato Grigio Satin Grey	TR +25%
SY	Specchio Mirror <sup>3</sup>	TR +50%

## PORTA / DOOR

L [cm]	COD.	L NOM. [cm]	A [cm]	B [cm]	C [cm]	[dm3]	[kg]	[n°]	V	ULU	L96 L91
66,2-68,7	B3705	65-67,5	23,3-25,8	41,7	56	73	26	1	TR	700,00	
									68,7-71,2	875,00	
68,7-71,2	B3706	67,5-70	23,3-25,8	44,2	60	76	26,5	1	TR	705,00	
									74,2-76,7	880,00	
71,7-74,2	B3707	70,5-73	24,8-27,3	45,7	62	74	27,5	1	TR	715,00	
									80,2-82,7	895,00	
74,2-76,7	B3708	73-75,5	24,8-27,3	45,7	62	80	28,5	1	TR	720,00	
									86,2-88,7	900,00	
77,7-80,2	B3709	76,5-79	27,3-29,8	51,7	70	85	29	1	TR	725,00	
									106,2-108,7	905,00	
80,2-82,7	B3710	79-81,5	27,3-29,8	51,7	70	84	30	1	TR	730,00	
									AS-RF	915,00	
83,2-85,7	B3711	82-84,5	30,3-32,8	51,7	70	83	30,5	1	TR	735,00	
									AS-RF	920,00	
86,2-88,7	B3712	85-87,5	33,3-35,8	51,7	70	89	31	1	TR	740,00	
									AS-RF	925,00	
96,2-98,7	B3713	95-97,5	37,3-39,8	57,7	79	99	34	1	TR	750,00	
									AS-RF	940,00	
106,2-108,7	B3714	105-107,5	47,2-49,7	57,7	79	99	37	1	TR	765,00	
									AS-RF	955,00	
116,2-118,7	B3715	115-117,5	57,3-59,8	57,7	79	114	39	1	TR	775,00	
									AS-RF	970,00	

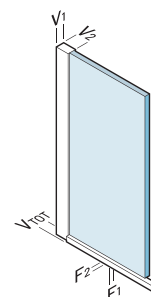

L	V1	V2	Vtot	F1	F2
	45mm	42mm	48mm	10mm	10mm

## PARETE FISSA DEDICATA / DEDICATED FIXED PANEL

H. 195cm  
SP. 6mm

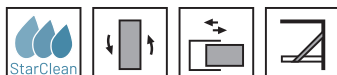

L [cm]	COD.	L1 NOM. [cm]	A [cm]	B [cm]	C [cm]	[dm3]	[kg]	[n°]	V	ULU	L96 L91
66,2-68,7	B3750	64-66,5	-	-	-	99	29	1	TR	615,00	
									AS-RF	770,00	
68,7-71,2	B3751	66,5-69	-	-	-	101	29	1	TR	620,00	
									AS-RF	775,00	
71,2-73,7	B3752	69-71,5	-	-	-	102	29	1	TR	625,00	
									AS-RF	780,00	
73,7-76,2	B3753	71,5-74	-	-	-	112	29	1	TR	630,00	
									AS-RF	790,00	
76,2-78,7	B3754	74-76,5	-	-	-	115	30	1	TR	630,00	
									AS-RF	790,00	
78,7-81,2	B3755	76,5-79	-	-	-	117	31	1	TR	635,00	
									AS-RF	795,00	
81,2-83,7	B3756	79-81,5	-	-	-	120	36	1	TR	640,00	
									AS-RF	800,00	
83,7-86,2	B3757	81,5-84	-	-	-	105	35	1	TR	640,00	
									AS-RF	800,00	
86,2-88,7	B3758	84-86,5	-	-	-	107	34	1	TR	645,00	
									AS-RF	805,00	
88,7-91,2	B3759	86,5-89	-	-	-	109	35	1	TR	650,00	
									AS-RF	815,00	
91,2-93,7	B3760	89-91,5	-	-	-	113	36	1	TR	655,00	
									AS-RF	820,00	

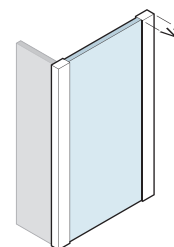

L1	V2
	42mm

SU MISURA/CUSTOM	PORTA DOOR	[€]	PARETE FISSA FIXED PANEL	[€]
Altezza/Height <sup>1</sup>	150-217cm	+20%	150-217cm	+20%
Larghezza/Width <sup>2</sup>	50-120cm	+20%	20-140cm	+20%
Altezza/Height Larghezza/Width <sup>2</sup>	150-217cm 50-120cm	+20%	150-217cm 20-140cm	+20%
Altre forme Other shapes <sup>2</sup>		+30%		+30%

OPTIONAL	COD.	[€]
Kit di sostegno Support kit	KT3700 (P.189) L.120cm	ULU L91-L96 150,00
Profilo di compensazione Compensation Profile	COM50A (+2cm)	ULU L91-L96 65,00

<sup>1</sup> Dal prezzo della misura di riferimento/From the price of selected size

<sup>2</sup> Dal prezzo della misura superiore/From the price of the larger size

<sup>3</sup> Contattare l'ufficio clienti per informazioni / Contact the customer service office for information

DISPONIBILITA' A MAGAZZINO / STOCK AVAILABILITY

1/2 Settimane/Weeks

2/3 Settimane/Weeks

3/4 Settimane/Weeks

# EUROPA











RIC1418LUC





- > Parete doccia con telaio
- > Vetro temperato 8mm per porte scorrevoli su configurazione ad angolo porte scorrevoli, 6mm per il resto della gamma
- > Trattamento anticalcare StarClean di serie incluso nel prezzo
- > Estensibilità e regolazione fuori squadra del muro fino a 3cm
- > Sgancio anta scorrevole per una agile pulizia del prodotto
- > Interasse maniglia 320mm
- > Stampa digitale disponibile su tutti i vetri piani TR

- > Shower enclosure with frame
- > 8mm tempered glass for sliding doors in corner configurations, 6mm for the rest of the range
- > StarClean anti-limescale treatment included in the price
- > Wall adjustment and out-of-square compensation up to 3cm
- > Detachable sliding door for easy product cleaning
- > Handle centre-to-centre distance 320mm
- > Digital printing available on all flat glasses TR

# EUROPA

## PRODOTTI DELLA SERIE / PRODUCTS OF THE SERIES

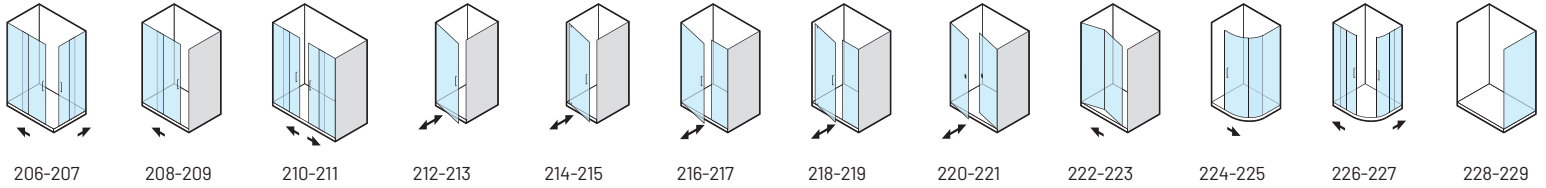

## PROFILI / PROFILES

### STANDARD



**ULU**  
Brilliantato Lucido  
*Brilliant Polished*

**SAR**  
Satinato Argento  
*Silver Glazed Satin*

**L01**  
Bianco Lucido  
*Glossy White*

## VETRO / GLASS

### STANDARD



**TR**  
Trasparente  
*Transparent*

**ST**  
Stampato  
*Printed*

**AS**  
Satinato  
*Satin*

### ON DEMAND



**TE**  
Extrachiaro  
*Extra Clear*

**TG**  
Trasparente Grigio  
*Transparent Grey*

**GS**  
Satinato Grigio  
*Satin Grey*

**RF**  
Fascia H.100cm  
*Band H.100cm*

**SY**  
Specchio  
*Mirror*

# EUROPA

LATO ANGOLO  
SIDE CORNER



Per istruzioni di montaggio  
e ricambi inquadra il codice QR  
For assembly instructions  
and spare parts, scan the QR code



**H. 200cm**  
**SP. 8mm (porta / door)**  
**SP. 6mm (fissa / fixed)**

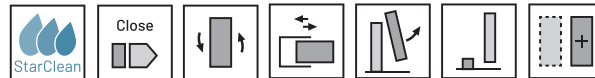

Parete doccia ad angolo a quattro ante, apertura ad ante scorrevoli nell'angolo del prodotto. Modello adatto per la maggior parte delle installazioni e disponibile in un'ampia gamma di dimensioni, soprattutto per chi vuole massimizzare le dimensioni d'ingresso.

*Corner shower wall with four panels, featuring sliding doors at the corner of the product. Suitable for most installations and available in a wide range of sizes, especially for those looking to maximize the entry dimensions.*

### CONFIGURAZIONE AD ANGOLO CORNER CONFIGURATION

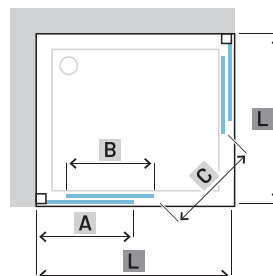

### CONFIGURAZIONE A TRE LATI THREE-SIDED CONFIGURATION

Per le configurazioni a tre lati considerare la parete fissa (L1).  
For three-sided configurations, consider the fixed panel (L1).

### ORIENTAMENTO E POSSIBILI COMBINAZIONI / ORIENTATION AND POSSIBLE CONFIGURATIONS

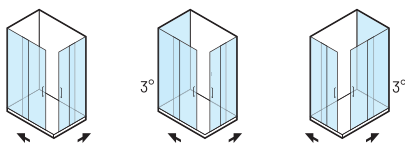

#### PROFILI / PROFILES

STANDARD	
<b>ULU</b>	Brillantato Lucido <i>Brilliant Polished</i>
<b>SAR</b>	Satinato Argento <i>Silver Glazed Satin</i>
<b>L01</b>	Bianco Lucido <i>Glossy White</i>

In finitura SAR, componentistica e maniglia sono in finitura cromata  
*In SAR finish, the components and handle are in a chrome finish*

#### VETRO / GLASS

STANDARD	
<b>TR</b>	Trasparente <i>Transparent</i>
<b>ST</b>	Stampato <i>Printed</i>
<b>AS</b>	Satinato <i>Satin</i>

ON DEMAND		
<b>TE</b>	Extrachiaro <i>Extra Clear</i>	TR +25%
<b>TG</b>	Trasparente Grigio <i>Transparent Grey</i>	TR +25%
<b>GS</b>	Satinato Grigio <i>Satin Grey</i>	TR +25%
<b>RF</b>	Fascia H.100cm <i>Band H.100cm</i>	TR +25%
<b>SY</b>	Specchio <i>Mirror</i> <sup>3</sup>	TR +50%

## PORTA / DOOR

L [cm]	COD.	A [cm]	B [cm]	C [cm]	[dm <sup>3</sup> ]	[kg]	[Pcs]	V	ULU	SAR	L01
67-70	B7816	31,2-34,2	33,8	34	118	28	1	TR	600,00	600,00	500,00
								ST	660,00	660,00	550,00
								AS	750,00	750,00	625,00
72-75	B7817	33,7-36,7	36,3	37	128	30	1	TR	615,00	615,00	515,00
								ST	675,00	675,00	565,00
								AS	770,00	770,00	645,00
77-80	B7818	36,2-39,2	38,8	41	137	33	1	TR	630,00	630,00	525,00
								ST	695,00	695,00	580,00
								AS	790,00	790,00	655,00
82-85	B7819	38,7-41,7	41,3	44	145	35	1	TR	645,00	645,00	540,00
								ST	710,00	710,00	595,00
								AS	805,00	805,00	675,00
87-90	B7820	41,2-44,2	43,8	48	151	38	1	TR	660,00	660,00	550,00
								ST	725,00	725,00	605,00
								AS	825,00	825,00	690,00
97-100	B7821	46,2-49,2	48,8	55	168	41	1	TR	690,00	690,00	575,00
								ST	760,00	760,00	635,00
								AS	865,00	865,00	720,00
107-110	B7822	56,2-59,2	48,8	55	184	44	1	TR	725,00	725,00	605,00
								ST	800,00	800,00	665,00
								AS	905,00	905,00	755,00
117-120	B7823	66,2-69,2	48,8	55	201	47	1	TR	755,00	755,00	630,00
								ST	830,00	830,00	695,00
								AS	945,00	945,00	790,00

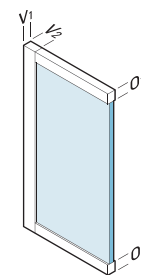

L	V1	V2	O1	O2
	28mm	45mm	45mm	45mm

I valori della tabella prezzi si riferiscono ad un singolo lato: sommare l'importo dei due codici della misura desiderata per ottenere il prezzo totale di una doccia ad angolo quadrata o rettangolare. Apertura (C) determinata con due lati della stessa misura.

The prices in the table refer to a single side: add the amounts of the two codes for the desired size to get the total price of a square or rectangular corner shower. Opening (C) is determined by two sides of the same size.

## PARETE FISSA / FIXED PANEL

H. 200cm  
SP. 6mm

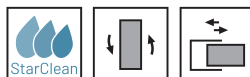

L1 [cm]	COD.	A [cm]	B [cm]	C [cm]	[dm <sup>3</sup> ]	[kg]	[Pcs]	V	ULU	SAR	L01
67-70	B7824	-	-	-	121	24	1	TR	400,00	400,00	335,00
								ST	440,00	440,00	370,00
								AS	500,00	500,00	420,00
72-75	B7825	-	-	-	126	26	1	TR	425,00	425,00	355,00
								ST	470,00	470,00	390,00
								AS	530,00	530,00	445,00
77-80	B7826	-	-	-	130	28	1	TR	445,00	445,00	370,00
								ST	490,00	490,00	405,00
								AS	555,00	555,00	465,00
82-85	B7827	-	-	-	135	30	1	TR	470,00	470,00	390,00
								ST	515,00	515,00	430,00
								AS	590,00	590,00	490,00
87-90	B7828	-	-	-	142	31	1	TR	490,00	490,00	410,00
								ST	540,00	540,00	450,00
								AS	615,00	615,00	515,00
97-100	B7829	-	-	-	149	33	1	TR	520,00	520,00	435,00
								ST	570,00	570,00	480,00
								AS	650,00	650,00	545,00

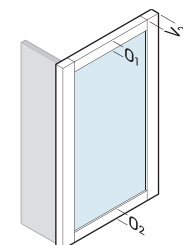

L1	V2	O1	O2
	45mm	45mm	45mm

SU MISURA/CUSTOM	PORTA DOOR	[€]	PARETE FISSA FIXED PANEL	[€]
Altezza/Height <sup>1</sup>	100-210cm	+20%	25-210cm	+20%
Larghezza/Width <sup>2</sup>	50-135cm	+20%	20-200cm	+20%
Altezza/Height Larghezza/Width <sup>2</sup>	100-210cm 50-135cm	+20%	25-210cm 20-200cm	+20%
Altre forme Other shapes <sup>2</sup>		+30%		+30%

OPTIONAL	COD.	[€]
Profilo compensazione Compensation Profile	L01	60,00
	COM10A (+3cm)	90,00
	SAR	90,00
Maniglia / Handle 1pc	RIC1418LUC	75,00

<sup>1</sup> Dal prezzo della misura di riferimento / From the price of selected size

<sup>2</sup> Dal prezzo della misura superiore / From the price of the larger size

<sup>3</sup> Contattare l'ufficio clienti per informazioni / Contact the customer service office for information

DISPONIBILITA' A MAGAZZINO / STOCK AVAILABILITY

1/2 Settimane/Weeks

2/3 Settimane/Weeks

3/4 Settimane/Weeks

# EUROPA

PORTA SCORREVOLE  
SLIDING DOOR



Per istruzioni di montaggio  
e ricambi inquadra il codice QR  
For assembly instructions  
and spare parts, scan the QR code



**H. 200cm**  
**SP. 6mm**

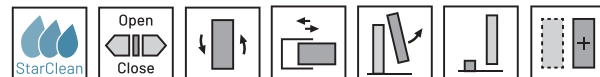

Parete doccia a due ante con apertura laterale scorrevole. Modello adatto per la maggior parte delle installazioni e disponibile in un'ampia gamma di dimensioni.

Shower wall with two panels and side sliding opening. Suitable for most installations and available in a wide range of sizes.

**CONFIGURAZIONE IN NICCHIA**  
**NICHE CONFIGURATION**

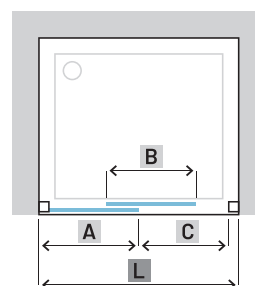

**CONFIGURAZIONE AD ANGOLO**  
**CORNER CONFIGURATION**

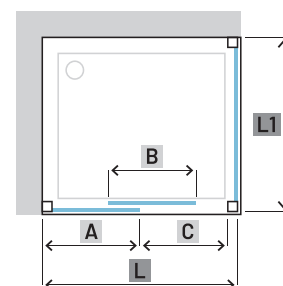

**CONFIGURAZIONE A TRE LATI**  
**THREE-SIDED CONFIGURATION**

Per le configurazioni a tre lati considerare la parete fissa (L1).  
For three-sided configurations, consider the fixed panel (L1).

## ORIENTAMENTO E POSSIBILI COMBINAZIONI / ORIENTATION AND POSSIBLE CONFIGURATIONS

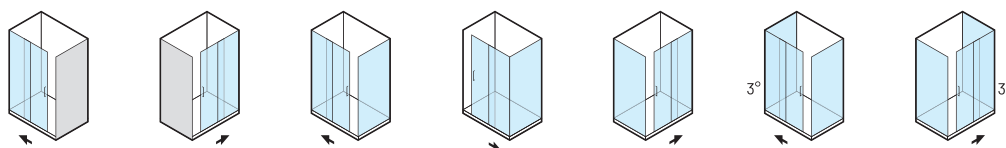

### PROFILI / PROFILES

STANDARD	
ULU	Brillantato Lucido Brilliant Polished
SAR	Satinato Argento Silver Glazed Satin
L01	Bianco Lucido Glossy White

In finitura SAR, componentistica e maniglia sono in finitura cromata  
In SAR finish, the components and handle are in a chrome finish

### VETRO / GLASS

STANDARD	
TR	Trasparente Transparent
ST	Stampato Printed
AS	Satinato Satin

ON DEMAND		
TE	Extrachiaro Extra Clear	TR +25%
TG	Trasparente Grigio Transparent Grey	TR +25%
GS	Satinato Grigio Satin Grey	TR +25%
RF	Fascia H.100cm Band H.100cm	TR +25%
SY	Specchio Mirror <sup>3</sup>	TR +50%

## PORTA / DOOR

L [cm]	COD.	A [cm]	B [cm]	C [cm]	[dm <sup>3</sup> ]	[kg]	[Pcs]	V	ULU	SAR	L01
96-102	B7880	45,8-48,8	46,8	36	121	37	1	TR	825,00	825,00	690,00
								RF	910,00	910,00	760,00
								AS	1.030,00	1.030,00	865,00
103-109	B7881	49-52	50,4	40	130	39	1	TR	845,00	845,00	705,00
								RF	930,00	930,00	775,00
								AS	1.055,00	1.055,00	880,00
110-116	B7882	52,5-55,5	53,9	43	137	40	1	TR	870,00	870,00	725,00
								RF	955,00	955,00	800,00
								AS	1.090,00	1.090,00	905,00
116-122	B7883	55,8-58,8	56,9	46	145	42	1	TR	890,00	890,00	740,00
								RF	980,00	980,00	815,00
								AS	1.115,00	1.115,00	925,00
123-129	B7884	59-62	60,4	50	156	44	1	TR	915,00	915,00	765,00
								RF	1.005,00	1.005,00	840,00
								AS	1.145,00	1.145,00	955,00
130-136	B7885	62,5-65,5	63,9	53	158	46	1	TR	945,00	945,00	790,00
								RF	1.040,00	1.040,00	870,00
								AS	1.180,00	1.180,00	990,00
136-142	B7886	65,5-68,5	66,9	56	260	51	2	TR	970,00	970,00	810,00
								RF	1.065,00	1.065,00	890,00
								AS	1.215,00	1.215,00	1.015,00
145-151	B7887	70-73	71,4	61	265	52	2	TR	995,00	995,00	830,00
								RF	1.095,00	1.095,00	915,00
								AS	1.245,00	1.245,00	1.040,00
152-158	B7888	73,8-76,8	74,9	64	273	54	2	TR	1.025,00	1.025,00	855,00
								RF	1.130,00	1.130,00	940,00
								AS	1.280,00	1.280,00	1.070,00
159-165	B7889	77-80	78,4	68	286	57	2	TR	1.055,00	1.055,00	880,00
								RF	1.160,00	1.160,00	970,00
								AS	1.320,00	1.320,00	1.100,00
166-172	B7890	80,5-83,5	81,9	71	294	60	2	TR	1.085,00	1.085,00	905,00
								RF	1.195,00	1.195,00	995,00
								AS	1.355,00	1.355,00	1.130,00
173-179	B7891	84-87	85,4	75	302	63	2	TR	1.110,00	1.110,00	925,00
								RF	1.220,00	1.220,00	1.020,00
								AS	1.390,00	1.390,00	1.155,00

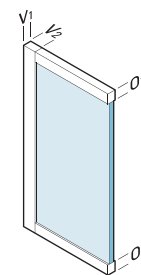

L
V <sub>1</sub> 47mm
V <sub>2</sub> 45mm
O <sub>1</sub> 45mm
O <sub>2</sub> 45mm

## PARETE FISSA / FIXED PANEL

H. 200cm  
SP. 6mm

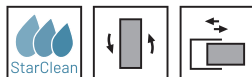

L1 [cm]	COD.	A [cm]	B [cm]	C [cm]	[dm <sup>3</sup> ]	[kg]	[Pcs]	V	ULU	SAR	L01
67-70	B7824	-	-	-	121	24	1	TR	400,00	400,00	335,00
								ST	440,00	440,00	370,00
								AS	500,00	500,00	420,00
72-75	B7825	-	-	-	126	26	1	TR	425,00	425,00	355,00
								ST	470,00	470,00	390,00
								AS	530,00	530,00	445,00
77-80	B7826	-	-	-	130	28	1	TR	445,00	445,00	370,00
								ST	490,00	490,00	405,00
								AS	555,00	555,00	465,00
82-85	B7827	-	-	-	135	30	1	TR	470,00	470,00	390,00
								ST	515,00	515,00	430,00
								AS	590,00	590,00	490,00
87-90	B7828	-	-	-	142	31	1	TR	490,00	490,00	410,00
								ST	540,00	540,00	450,00
								AS	615,00	615,00	515,00
97-100	B7829	-	-	-	149	33	1	TR	520,00	520,00	435,00
								ST	570,00	570,00	480,00
								AS	650,00	650,00	545,00

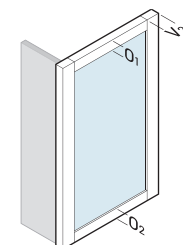

L1
V <sub>2</sub> 45mm
O <sub>1</sub> 45mm
O <sub>2</sub> 45mm

SU MISURA/CUSTOM	PORTA DOOR	[€]	PARETE FISSA FIXED PANEL	[€]
Altezza/Height <sup>1</sup>	100-210cm	+20%	25-210cm	+20%
Larghezza/Width <sup>2</sup>	80-185cm	+20%	20-200cm	+20%
Altezza/Height	100-210cm	+20%	25-210cm	+20%
Larghezza/Width <sup>2</sup>	80-185cm	+20%	20-200cm	+20%
Altre forme Other shapes <sup>2</sup>		+30%		+30%

OPTIONAL	COD.	[€]
Profilo compensazione Compensation Profile	COM10A (+3cm)	60,00
	L01	
	ULU	90,00
	SAR	90,00
Maniglia / Handle 1pc	RIC1418LUC	75,00
	ULU	

<sup>1</sup> Dal prezzo della misura di riferimento / From the price of selected size

<sup>2</sup> Dal prezzo della misura superiore / From the price of the larger size

<sup>3</sup> Contattare l'ufficio clienti per informazioni / Contact the customer service office for information

DISPONIBILITA' A MAGAZZINO / STOCK AVAILABILITY

1/2 Settimane/Weeks

2/3 Settimane/Weeks

3/4 Settimane/Weeks

# EUROPA

DOPPIA PORTA SCORREVOLE  
DOUBLE SLIDING DOORS



Per istruzioni di montaggio  
e ricambi inquadra il codice QR  
For assembly instructions  
and spare parts, scan the QR code



H. 200cm  
SP. 6mm

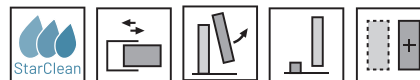

Parete doccia a quattro ante con apertura centrale. L'apertura è centrale data dalle due ante centrali scorrevoli in modo contrapposto. Modello adatto per installazioni di generose dimensioni.

Shower enclosure with four panels and a central opening. The opening is created by the two central sliding doors, which move in opposite directions. This model is suitable for large-scale installations.

CONFIGURAZIONE IN NICCHIA  
NICHE CONFIGURATION

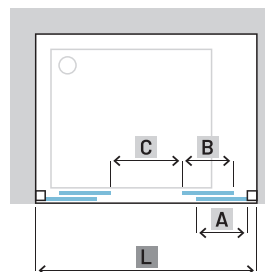

CONFIGURAZIONE AD ANGOLO  
CORNER CONFIGURATION

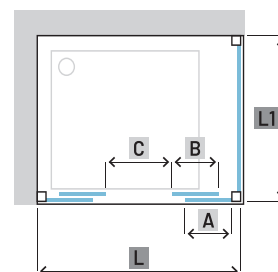

CONFIGURAZIONE A TRE LATI  
THREE-SIDED CONFIGURATION

Per le configurazioni a tre lati considerare la parete fissa (L1).  
For three-sided configurations, consider the fixed panel (L1).

## ORIENTAMENTO E POSSIBILI COMBINAZIONI / ORIENTATION AND POSSIBLE CONFIGURATIONS

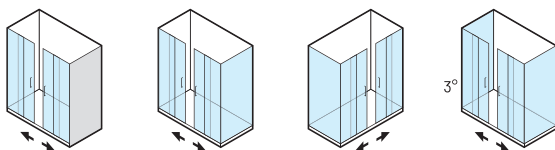

### PROFILI / PROFILES

STANDARD	
ULU	Brillantato Lucido Brilliant Polished
SAR	Satinato Argento Silver Glazed Satin
L01	Bianco Lucido Glossy White

In finitura SAR, componentistica e maniglia sono in finitura cromata  
In SAR finish, the components and handle are in a chrome finish

### VETRO / GLASS

STANDARD	
TR	Trasparente Transparent
ST	Stampato Printed
AS	Satinato Satin

ON DEMAND		
TE	Extrachiaro Extra Clear	TR +25%
TG	Trasparente Grigio Transparent Grey	TR +25%
GS	Satinato Grigio Satin Grey	TR +25%
RF	Fascia H.100cm Band H.100cm	TR +25%
SY	Specchio Mirror <sup>3</sup>	TR +50%

## PORTA / DOOR

L [cm]	COD.	A [cm]	B [cm]	C [cm]	[dm3]	[kg]	[Pcs]	V	ULU	SAR	L01
136-142	B7844	33,7-36,7	36,4	53	169	53	2	TR	1.120,00	1.120,00	935,00
								ST	1.230,00	1.230,00	1.030,00
								AS	1.400,00	1.400,00	1.170,00
146-152	B7845	36,2-39,2	38,9	58	178	57	2	TR	1.150,00	1.150,00	960,00
								ST	1.265,00	1.265,00	1.055,00
								AS	1.440,00	1.440,00	1.200,00
156-162	B7846	38,7-41,7	41,4	63	181	58	2	TR	1.170,00	1.170,00	975,00
								ST	1.285,00	1.285,00	1.075,00
								AS	1.465,00	1.465,00	1.220,00
166-172	B7847	41,2-44,2	43,9	68	192	61	2	TR	1.200,00	1.200,00	1.000,00
								ST	1.320,00	1.320,00	1.100,00
								AS	1.500,00	1.500,00	1.250,00
176-182	B7848	43,7-46,7	46,4	73	200	63	2	TR	1.225,00	1.225,00	1.020,00
								ST	1.350,00	1.350,00	1.120,00
								AS	1.530,00	1.530,00	1.275,00

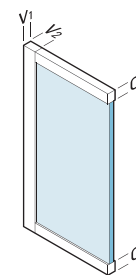

L	V1	V2	O1	O2
	47mm	45mm	45mm	45mm

## PARETE FISSA / FIXED PANEL

H. 200cm  
SP. 6mm

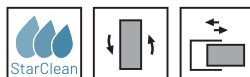

L1 [cm]	COD.	A [cm]	B [cm]	C [cm]	[dm3]	[kg]	[Pcs]	V	ULU	SAR	L01
67-70	B7824	-	-	-	121	24	1	TR	400,00	400,00	335,00
								ST	440,00	440,00	370,00
								AS	500,00	500,00	420,00
72-75	B7825	-	-	-	126	26	1	TR	425,00	425,00	355,00
								ST	470,00	470,00	390,00
								AS	530,00	530,00	445,00
77-80	B7826	-	-	-	130	28	1	TR	445,00	445,00	370,00
								ST	490,00	490,00	405,00
								AS	555,00	555,00	465,00
82-85	B7827	-	-	-	135	30	1	TR	470,00	470,00	390,00
								ST	515,00	515,00	430,00
								AS	590,00	590,00	490,00
87-90	B7828	-	-	-	142	31	1	TR	490,00	490,00	410,00
								ST	540,00	540,00	450,00
								AS	615,00	615,00	515,00
97-100	B7829	-	-	-	149	33	1	TR	520,00	520,00	435,00
								ST	570,00	570,00	480,00
								AS	650,00	650,00	545,00

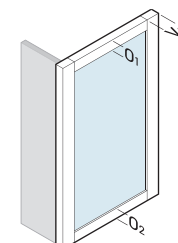

L1	V2	O1	O2
	45mm	45mm	45mm

SU MISURA/CUSTOM	PORTA DOOR	[€]	PARETE FISSA FIXED PANEL	[€]
Altezza/Height <sup>1</sup>	100-210cm	+20%	25-210cm	+20%
Larghezza/Width <sup>2</sup>	100-200cm	+20%	20-200cm	+20%
Altezza/Height Larghezza/Width <sup>2</sup>	100-210cm 100-200cm	+20%	25-210cm 20-200cm	+20%
Altre forme Other shapes <sup>2</sup>		+30%		+30%

OPTIONAL	COD.	[€]
Profilo compensazione Compensation Profile	L01	60,00
	ULU	90,00
	SAR	90,00
Maniglia / Handle 1pc	RIC1418LUC	75,00

<sup>1</sup> Dal prezzo della misura di riferimento / From the price of selected size

<sup>2</sup> Dal prezzo della misura superiore / From the price of the larger size

<sup>3</sup> Contattare l'ufficio clienti per informazioni / Contact the customer service office for information

DISPONIBILITA' A MAGAZZINO / STOCK AVAILABILITY

1/2 Settimane/Weeks

2/3 Settimane/Weeks

3/4 Settimane/Weeks

# EUROPA

PORTA BATTENTE  
HINGED DOOR



Per istruzioni di montaggio  
e ricambi inquadra il codice QR  
For assembly instructions  
and spare parts, scan the QR code



H. 200cm  
SP. 6mm

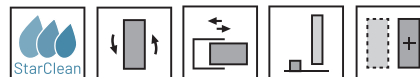

Parete doccia con apertura a porta battente. L'apertura dell'anta è sia verso l'interno che verso l'esterno. Modello adatto per situazioni che necessitano della massima apertura possibile.

Shower enclosure with a hinged door. The door opens both inward and outward. A model suitable for situations requiring the maximum possible opening.

CONFIGURAZIONE IN NICCHIA  
NICHE CONFIGURATION

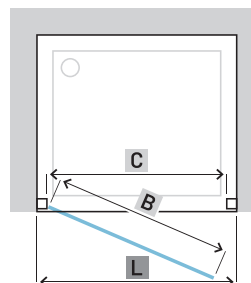

CONFIGURAZIONE AD ANGOLO  
CORNER CONFIGURATION

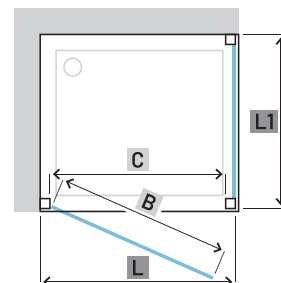

CONFIGURAZIONI A TRE LATI  
THREE-SIDED CONFIGURATIONS

Non è possibile realizzare configurazioni a tre lati.  
It is not possible to create three-sided corner configurations.

## ORIENTAMENTO E POSSIBILI COMBINAZIONI / ORIENTATION AND POSSIBLE CONFIGURATIONS

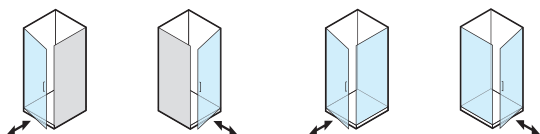

### PROFILI / PROFILES

STANDARD	
ULU	Brillantato Lucido Brilliant Polished
SAR	Satinato Argento Silver Glazed Satin
L01	Bianco Lucido Glossy White

In finitura SAR, componentistica e maniglia sono in finitura cromata  
In SAR finish, the components and handle are in a chrome finish

### VETRO / GLASS

STANDARD	
TR	Trasparente Transparent
ST	Stampato Printed
AS	Satinato Satin

ON DEMAND		
TE	Extrachiaro Extra Clear	TR +25%
TG	Trasparente Grigio Transparent Grey	TR +25%
GS	Satinato Grigio Satin Grey	TR +25%
RF	Fascia H.100cm Band H.100cm	TR +25%
SY	Specchio Mirror <sup>3</sup>	TR +50%

## PORTA / DOOR

L [cm]	COD.	A [cm]	B [cm]	C [cm]	[dm3]	[kg]	[Pcs]	V	ULU	SAR	L01
66-72	B7802	-	52,7	52	117	24	1	TR	640,00	640,00	535,00
								ST	705,00	705,00	590,00
								AS	800,00	800,00	670,00
72-78	B7803	-	58,7	58	131	27	1	TR	665,00	665,00	555,00
								ST	730,00	730,00	610,00
								AS	830,00	830,00	695,00
78-84	B7804	-	64,7	64	148	30	1	TR	685,00	685,00	570,00
								ST	755,00	755,00	625,00
								AS	855,00	855,00	715,00
86-92	B7805	-	72,7	72	163	33	1	TR	710,00	710,00	590,00
								ST	780,00	780,00	650,00
								AS	890,00	890,00	740,00
96-102	B7806	-	82,7	82	175	35	1	TR	735,00	735,00	615,00
								ST	810,00	810,00	675,00
								AS	920,00	920,00	770,00

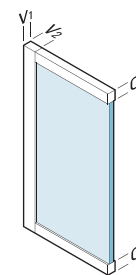

L	V1	V2	O1	O2
	47mm	45mm	45mm	45mm

## PARETE FISSA / FIXED PANEL

H. 200cm  
SP. 6mm

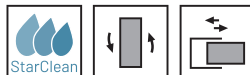

L1 [cm]	COD.	A [cm]	B [cm]	C [cm]	[dm3]	[kg]	[Pcs]	V	ULU	SAR	L01
67-70	B7824	-	-	-	121	24	1	TR	400,00	400,00	335,00
								ST	440,00	440,00	370,00
								AS	500,00	500,00	420,00
72-75	B7825	-	-	-	126	26	1	TR	425,00	425,00	355,00
								ST	470,00	470,00	390,00
								AS	530,00	530,00	445,00
77-80	B7826	-	-	-	130	28	1	TR	445,00	445,00	370,00
								ST	490,00	490,00	405,00
								AS	555,00	555,00	465,00
82-85	B7827	-	-	-	135	30	1	TR	470,00	470,00	390,00
								ST	515,00	515,00	430,00
								AS	590,00	590,00	490,00
87-90	B7828	-	-	-	142	31	1	TR	490,00	490,00	410,00
								ST	540,00	540,00	450,00
								AS	615,00	615,00	515,00
97-100	B7829	-	-	-	149	33	1	TR	520,00	520,00	435,00
								ST	570,00	570,00	480,00
								AS	650,00	650,00	545,00

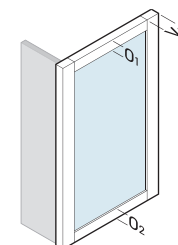

L1	V2	O1	O2
	45mm	45mm	45mm

SU MISURA/CUSTOM	PORTA DOOR	[€]	PARETE FISSA FIXED PANEL	[€]
Altezza/Height <sup>1</sup>	100-210cm	+20%	25-210cm	+20%
Larghezza/Width <sup>2</sup>	50-100cm	+20%	20-200cm	+20%
Altezza/Height Larghezza/Width <sup>2</sup>	100-210cm 50-100cm	+20%	25-210cm 20-200cm	+20%
Altre forme Other shapes <sup>2</sup>		+30%		+30%

OPTIONAL	COD.	[€]
Profilo compensazione Compensation Profile	L01	60,00
	ULU	90,00
	SAR	90,00
Maniglia / Handle 1pc	RIC1418LUC	75,00

<sup>1</sup> Dal prezzo della misura di riferimento / From the price of selected size

<sup>2</sup> Dal prezzo della misura superiore / From the price of the larger size

<sup>3</sup> Contattare l'ufficio clienti per informazioni / Contact the customer service office for information

DISPONIBILITA' A MAGAZZINO / STOCK AVAILABILITY

1/2 Settimane/Weeks

2/3 Settimane/Weeks

3/4 Settimane/Weeks

# EUROPA

PORTA BATTENTE PIVOT  
PIVOT HINGED DOOR



Per istruzioni di montaggio  
e ricambi inquadra il codice QR  
For assembly instructions  
and spare parts, scan the QR code



**H. 200cm**  
**SP. 6mm**

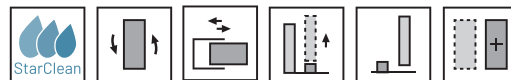

Parete doccia con apertura a porta battente pivotante. L'apertura dell'anta è sia verso l'interno che verso l'esterno. Modello adatto per situazioni che necessitano di aperture generose, ma di ingombri minimizzati all'interno del bagno.

Shower enclosure with a pivoting hinged door. The door opens both inward and outward. A model suitable for situations requiring generous openings while minimizing space usage inside the bathroom.

**CONFIGURAZIONE IN NICCHIA**  
**NICHE CONFIGURATION**

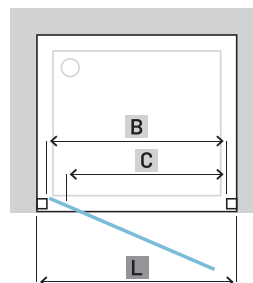

**CONFIGURAZIONE AD ANGOLO**  
**CORNER CONFIGURATION**

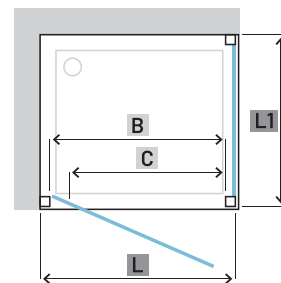

**CONFIGURAZIONI A TRE LATI**  
**THREE-SIDED CONFIGURATIONS**

Non è possibile realizzare configurazioni a tre lati.  
It is not possible to create three-sided configurations.

## ORIENTAMENTO E POSSIBILI COMBINAZIONI / ORIENTATION AND POSSIBLE CONFIGURATIONS

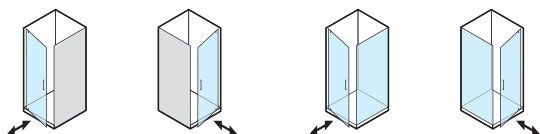

### PROFILI / PROFILES

STANDARD	
ULU	Brillantato Lucido Brilliant Polished
SAR	Satinato Argento Silver Glazed Satin
L01	Bianco Lucido Glossy White

In finitura SAR, componentistica e maniglia sono in finitura cromata  
In SAR finish, the components and handle are in a chrome finish

### VETRO / GLASS

STANDARD	
TR	Trasparente Transparent
ST	Stampato Printed
AS	Satinato Satin

ON DEMAND		
TE	Extrachiaro Extra Clear	TR +25%
TG	Trasparente Grigio Transparent Grey	TR +25%
GS	Satinato Grigio Satin Grey	TR +25%
RF	Fascia H.100cm Band H.100cm	TR +25%
SY	Specchio Mirror <sup>3</sup>	TR +50%

## PORTA / DOOR

L [cm]	COD.	A [cm]	B [cm]	C [cm]	[dm3]	[kg]	[Pcs]	V	ULU	SAR	L01
66-72	B7855	-	45,5	54,5	119	23	1	TR	640,00	640,00	535,00
								ST	705,00	705,00	590,00
								AS	800,00	800,00	670,00
72-78	B7856	-	51,5	60,5	128	27,5	1	TR	665,00	665,00	555,00
								ST	730,00	730,00	610,00
								AS	830,00	830,00	695,00
78-84	B7857	-	57,5	66,5	138	30	1	TR	685,00	685,00	570,00
								ST	755,00	755,00	625,00
								AS	855,00	855,00	715,00
86-92	B7858	-	65,5	74,5	153	32,5	1	TR	710,00	710,00	590,00
								ST	780,00	780,00	650,00
								AS	890,00	890,00	740,00
96-102	B7859	-	75,5	84,5	169	35	1	TR	735,00	735,00	615,00
								ST	810,00	810,00	675,00
								AS	920,00	920,00	770,00

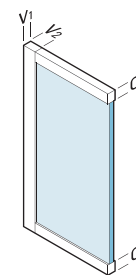

L	V1	V2	O1	O2
	47mm	45mm	45mm	45mm

## PARETE FISSA / FIXED PANEL

H. 200cm  
SP. 6mm

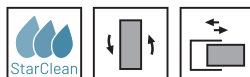

L1 [cm]	COD.	A [cm]	B [cm]	C [cm]	[dm3]	[kg]	[Pcs]	V	ULU	SAR	L01
67-70	B7824	-	-	-	121	24	1	TR	400,00	400,00	335,00
								ST	440,00	440,00	370,00
								AS	500,00	500,00	420,00
72-75	B7825	-	-	-	126	26	1	TR	425,00	425,00	355,00
								ST	470,00	470,00	390,00
								AS	530,00	530,00	445,00
77-80	B7826	-	-	-	130	28	1	TR	445,00	445,00	370,00
								ST	490,00	490,00	405,00
								AS	555,00	555,00	465,00
82-85	B7827	-	-	-	135	30	1	TR	470,00	470,00	390,00
								ST	515,00	515,00	430,00
								AS	590,00	590,00	490,00
87-90	B7828	-	-	-	142	31	1	TR	490,00	490,00	410,00
								ST	540,00	540,00	450,00
								AS	615,00	615,00	515,00
97-100	B7829	-	-	-	149	33	1	TR	520,00	520,00	435,00
								ST	570,00	570,00	480,00
								AS	650,00	650,00	545,00

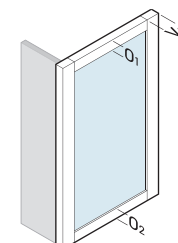

L1	V2	O1	O2
	45mm	45mm	45mm

SU MISURA/CUSTOM	PORTA DOOR	[€]	PARETE FISSA FIXED PANEL	[€]
Altezza/Height <sup>1</sup>	100-210cm	+20%	25-210cm	+20%
Larghezza/Width <sup>2</sup>	50-100cm	+20%	20-200cm	+20%
Altezza/Height Larghezza/Width <sup>2</sup>	100-210cm 50-100cm	+20%	25-210cm 20-200cm	+20%
Altre forme Other shapes <sup>2</sup>		+30%		+30%

OPTIONAL	COD.	[€]
Profilo compensazione Compensation Profile	L01	60,00
	ULU	90,00
	SAR	90,00
Maniglia / Handle 1pc	RIC1418LUC	75,00

<sup>1</sup> Dal prezzo della misura di riferimento / From the price of selected size

<sup>2</sup> Dal prezzo della misura superiore / From the price of the larger size

<sup>3</sup> Contattare l'ufficio clienti per informazioni / Contact the customer service office for information

DISPONIBILITA' A MAGAZZINO / STOCK AVAILABILITY

1/2 Settimane/Weeks

2/3 Settimane/Weeks

3/4 Settimane/Weeks

# EUROPA

PORTA BATTENTE SU FISSO IN LINEA  
HINGED DOOR ON FIXED INLINE PANEL



Per istruzioni di montaggio  
e ricambi inquadra il codice QR  
For assembly instructions  
and spare parts, scan the QR code



H. 200cm  
SP. 6mm

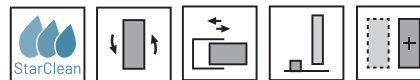

Parete doccia con apertura a porta battente su parete fissa in linea. L'apertura dell'anta è sia verso l'interno che verso l'esterno. Modello ad alto impatto estetico e disponibile in dimensioni maggiori rispetto ad una tradizionale porta.

Shower enclosure with a hinged door on a fixed inline panel. The door opens both inward and outward. A model with high aesthetic impact and available in larger sizes compared to a traditional door.

CONFIGURAZIONE IN NICCHIA  
NICHE CONFIGURATION

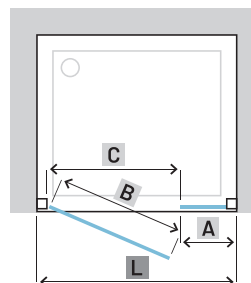

CONFIGURAZIONE AD ANGOLO  
CORNER CONFIGURATION

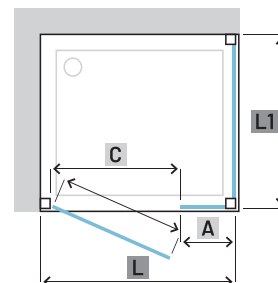

CONFIGURAZIONE A TRE LATI  
THREE-SIDED CONFIGURATION

Per le configurazioni a tre lati considerare la parete fissa (L1).  
For three-sided configurations, consider the fixed panel (L1).

## ORIENTAMENTO E POSSIBILI COMBINAZIONI / ORIENTATION AND POSSIBLE CONFIGURATIONS

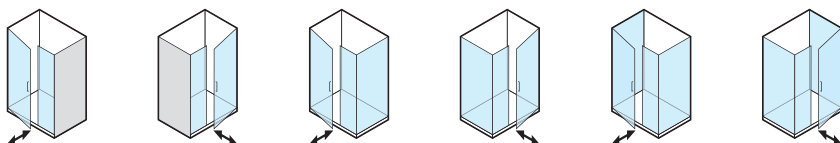

### PROFILI / PROFILES

STANDARD	
ULU	Brillantato Lucido Brilliant Polished
SAR	Satinato Argento Silver Glazed Satin
L01	Bianco Lucido Glossy White

In finitura SAR, componentistica e maniglia sono in finitura cromata  
In SAR finish, the components and handle are in a chrome finish

### VETRO / GLASS

STANDARD	
TR	Trasparente Transparent
ST	Stampato Printed
AS	Satinato Satin

ON DEMAND		
TE	Extrachiaro Extra Clear	TR +25%
TG	Trasparente Grigio Transparent Grey	TR +25%
GS	Satinato Grigio Satin Grey	TR +25%
RF	Fascia H.100cm Band H.100cm	TR +25%
SY	Specchio Mirror <sup>3</sup>	TR +50%

## PORTA / DOOR

L [cm]	COD.	A [cm]	B [cm]	C [cm]	[dm <sup>3</sup> ]	[kg]	[Pcs]	V	ULU	SAR	L01
96-102	B7870	35,1-38,1	53,8	52	121	37	1	TR	950,00	950,00	790,00
								ST	1.045,00	1.045,00	870,00
								AS	1.190,00	1.190,00	990,00
106-112	B7871	33,1-36,1	65,8	64	137	40	1	TR	975,00	975,00	815,00
								ST	1.075,00	1.075,00	895,00
								AS	1.220,00	1.220,00	1.020,00
116-122	B7872	35,1-38,1	73,8	72	145	42	2	TR	1.000,00	1.000,00	835,00
								ST	1.100,00	1.100,00	920,00
								AS	1.250,00	1.250,00	1.045,00
126-132	B7873	45,1-48,1	73,8	72	158	46	2	TR	1.030,00	1.030,00	860,00
								ST	1.135,00	1.135,00	945,00
								AS	1.290,00	1.290,00	1.075,00
136-142	B7874	55,1-58,1	73,8	72	260	51	2	TR	1.060,00	1.060,00	885,00
								ST	1.165,00	1.165,00	975,00
								AS	1.325,00	1.325,00	1.105,00
146-152	B7875	65,1-68,1	73,8	72	265	52	2	TR	1.090,00	1.090,00	910,00
								ST	1.200,00	1.200,00	1.000,00
								AS	1.365,00	1.365,00	1.140,00

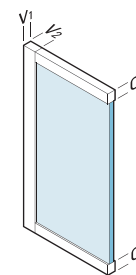

L	V1	V2	O1	O2
	47mm	45mm	45mm	45mm

## PARETE FISSA / FIXED PANEL

H. 200cm  
SP. 6mm

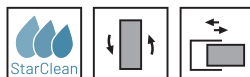

L1 [cm]	COD.	A [cm]	B [cm]	C [cm]	[dm <sup>3</sup> ]	[kg]	[Pcs]	V	ULU	SAR	L01
67-70	B7824	-	-	-	121	24	1	TR	400,00	400,00	335,00
								ST	440,00	440,00	370,00
								AS	500,00	500,00	420,00
72-75	B7825	-	-	-	126	26	1	TR	425,00	425,00	355,00
								ST	470,00	470,00	390,00
								AS	530,00	530,00	445,00
77-80	B7826	-	-	-	130	28	1	TR	445,00	445,00	370,00
								ST	490,00	490,00	405,00
								AS	555,00	555,00	465,00
82-85	B7827	-	-	-	135	30	1	TR	470,00	470,00	390,00
								ST	515,00	515,00	430,00
								AS	590,00	590,00	490,00
87-90	B7828	-	-	-	142	31	1	TR	490,00	490,00	410,00
								ST	540,00	540,00	450,00
								AS	615,00	615,00	515,00
97-100	B7829	-	-	-	149	33	1	TR	520,00	520,00	435,00
								ST	570,00	570,00	480,00
								AS	650,00	650,00	545,00

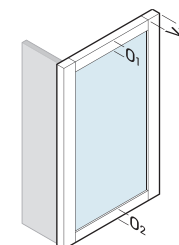

L1	V2	O1	O2
	45mm	45mm	45mm

SU MISURA/CUSTOM	PORTA DOOR	[€]	PARETE FISSA FIXED PANEL	[€]
Altezza/Height <sup>1</sup>	100-210cm	+20%	25-210cm	+20%
Larghezza/Width <sup>2</sup>	80-195cm	+20%	20-200cm	+20%
Altezza/Height Larghezza/Width <sup>2</sup>	100-210cm 80-195cm	+20%	25-210cm 20-200cm	+20%
Altre forme Other shapes <sup>2</sup>		+30%		+30%

OPTIONAL	COD.	[€]
Profilo compensazione Compensation Profile	L01	60,00
	COM10A (+3cm)	90,00
	SAR	90,00
Maniglia / Handle 1pc	RIC1418LUC	75,00

<sup>1</sup> Dal prezzo della misura di riferimento / From the price of selected size

<sup>2</sup> Dal prezzo della misura superiore / From the price of the larger size

<sup>3</sup> Contattare l'ufficio clienti per informazioni / Contact the customer service office for information

DISPONIBILITA' A MAGAZZINO / STOCK AVAILABILITY

1/2 Settimane/Weeks

2/3 Settimane/Weeks

3/4 Settimane/Weeks

# EUROPA

PORTA BATTENTE PIVOT SU FISSO IN LINEA  
PIVOT HINGED DOOR ON FIXED INLINE PANEL



Per istruzioni di montaggio  
e ricambi inquadra il codice QR  
For assembly instructions  
and spare parts, scan the QR code



**H. 200cm**  
**SP. 6mm**

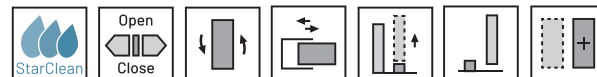

Parete doccia con apertura a porta battente pivotante su parete fissa in linea. L'apertura dell'anta è sia verso l'interno che verso l'esterno. Modello ad alto impatto estetico e disponibile in dimensioni maggiori rispetto ad una tradizionale porta.

Shower enclosure with a pivoting hinged door on a fixed inline panel. The door opens both inward and outward. A model with high aesthetic impact and available in larger sizes compared to a traditional door.

**CONFIGURAZIONE IN NICCHIA**  
**NICHE CONFIGURATION**

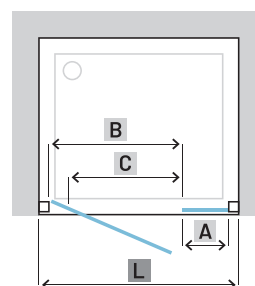

**CONFIGURAZIONE AD ANGOLO**  
**CORNER CONFIGURATION**

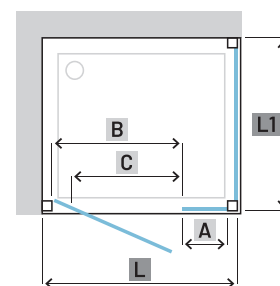

**CONFIGURAZIONE A TRE LATI**  
**THREE-SIDED CONFIGURATION**

Per le configurazioni a tre lati considerare la parete fissa (L1).  
For three-sided configurations, consider the fixed panel (L1).

## ORIENTAMENTO E POSSIBILI COMBINAZIONI / ORIENTATION AND POSSIBLE CONFIGURATIONS

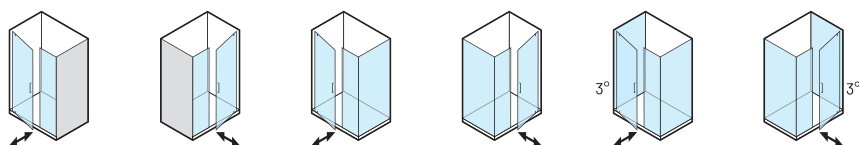

### PROFILI / PROFILES

STANDARD	
ULU	Brillantato Lucido Brilliant Polished
SAR	Satinato Argento Silver Glazed Satin
L01	Bianco Lucido Glossy White

In finitura SAR, componentistica e maniglia sono in finitura cromata  
In SAR finish, the components and handle are in a chrome finish

### VETRO / GLASS

STANDARD	
TR	Trasparente Transparent
ST	Stampato Printed
AS	Satinato Satin

ON DEMAND		
TE	Extrachiaro Extra Clear	TR +25%
TG	Trasparente Grigio Transparent Grey	TR +25%
GS	Satinato Grigio Satin Grey	TR +25%
RF	Fascia H.100cm Band H.100cm	TR +25%
SY	Specchio Mirror <sup>3</sup>	TR +50%

## PORTA / DOOR

L [cm]	COD.	A [cm]	B [cm]	C [cm]	[dm <sup>3</sup> ]	[kg]	[Pcs]	V	ULU	SAR	L01
96-102	B7864	35,9	45,5	45	121	37	1	TR	950,00	950,00	790,00
								ST	1.045,00	1.045,00	870,00
								AS	1.190,00	1.190,00	990,00
106-112	B7865	33,9	57,5	57	137	40	1	TR	975,00	975,00	815,00
								ST	1.075,00	1.075,00	895,00
								AS	1.220,00	1.220,00	1.020,00
116-122	B7866	35,9	65,5	65	145	42	2	TR	1.000,00	1.000,00	835,00
								ST	1.100,00	1.100,00	920,00
								AS	1.250,00	1.250,00	1.045,00
126-132	B7867	45,9	65,5	65	158	46	2	TR	1.030,00	1.030,00	860,00
								ST	1.135,00	1.135,00	945,00
								AS	1.290,00	1.290,00	1.075,00
136-142	B7868	55,9	65,5	65	192	51	2	TR	1.060,00	1.060,00	885,00
								ST	1.165,00	1.165,00	975,00
								AS	1.325,00	1.325,00	1.105,00
146-152	B7869	65,9	65,5	65	192	52	2	TR	1.090,00	1.090,00	910,00
								ST	1.200,00	1.200,00	1.000,00
								AS	1.365,00	1.365,00	1.140,00

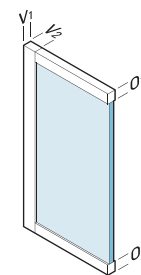

L	V1	V2	O1	O2
	47mm	45mm	45mm	45mm

## PARETE FISSA / FIXED PANEL

H. 200cm  
SP. 6mm

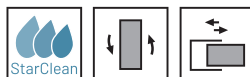

L1 [cm]	COD.	A [cm]	B [cm]	C [cm]	[dm <sup>3</sup> ]	[kg]	[Pcs]	V	ULU	SAR	L01
67-70	B7824	-	-	-	121	24	1	TR	400,00	400,00	335,00
								ST	440,00	440,00	370,00
								AS	500,00	500,00	420,00
72-75	B7825	-	-	-	126	26	1	TR	425,00	425,00	355,00
								ST	470,00	470,00	390,00
								AS	530,00	530,00	445,00
77-80	B7826	-	-	-	130	28	1	TR	445,00	445,00	370,00
								ST	490,00	490,00	405,00
								AS	555,00	555,00	465,00
82-85	B7827	-	-	-	135	30	1	TR	470,00	470,00	390,00
								ST	515,00	515,00	430,00
								AS	590,00	590,00	490,00
87-90	B7828	-	-	-	142	31	1	TR	490,00	490,00	410,00
								ST	540,00	540,00	450,00
								AS	615,00	615,00	515,00
97-100	B7829	-	-	-	149	33	1	TR	520,00	520,00	435,00
								ST	570,00	570,00	480,00
								AS	650,00	650,00	545,00

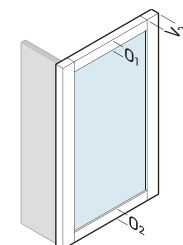

L1	V2	O1	O2
	45mm	45mm	45mm

SU MISURA/CUSTOM	PORTA DOOR	[€]	PARETE FISSA FIXED PANEL	[€]
Altezza/Height <sup>1</sup>	100-210cm	+20%	25-210cm	+20%
Larghezza/Width <sup>2</sup>	80-195cm	+20%	20-200cm	+20%
Altezza/Height Larghezza/Width <sup>2</sup>	100-210cm 80-195cm	+20%	25-210cm 20-200cm	+20%
Altre forme Other shapes <sup>2</sup>		+30%		+30%

OPTIONAL	COD.	[€]
Profilo compensazione Compensation Profile	L01	60,00
	COM10A (+3cm)	90,00
	SAR	90,00
Maniglia / Handle 1pc	RIC1418LUC	75,00

<sup>1</sup> Dal prezzo della misura di riferimento / From the price of selected size

<sup>2</sup> Dal prezzo della misura superiore / From the price of the larger size

<sup>3</sup> Contattare l'ufficio clienti per informazioni / Contact the customer service office for information

DISPONIBILITA' A MAGAZZINO / STOCK AVAILABILITY

1/2 Settimane/Weeks

2/3 Settimane/Weeks

3/4 Settimane/Weeks

# EUROPA

PORTA SALOON  
SALOON DOOR



Per istruzioni di montaggio  
e ricambi inquadra il codice QR  
For assembly instructions  
and spare parts, scan the QR code



**H. 200cm**  
**SP. 6mm**

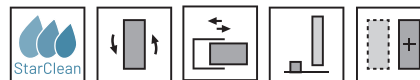

Parete doccia con due ante con apertura a saloon. L'apertura delle ante è sia verso l'interno che verso l'esterno. Modello adatto per situazioni che necessitano di un ingresso ampio, ma con spazio di installazione limitato.

Shower enclosure with two saloon-style doors. The doors open both inward and outward. A model suitable for situations requiring a wide entry but with limited installation space.

**CONFIGURAZIONE IN NICCHIA**  
**NICHE CONFIGURATION**

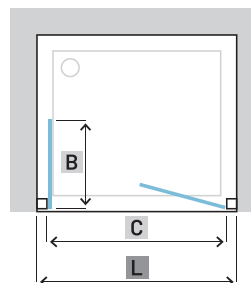

**CONFIGURAZIONE AD ANGOLO**  
**CORNER CONFIGURATION**

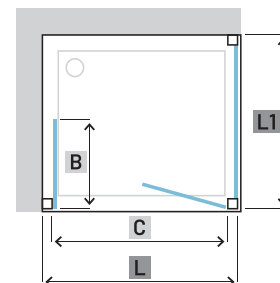

**CONFIGURAZIONE A TRE LATI**  
**THREE-SIDED CONFIGURATION**

Per le configurazioni a tre lati considerare la parete fissa (L1).  
For three-sided configurations, consider the fixed panel (L1).

## ORIENTAMENTO E POSSIBILI COMBINAZIONI / ORIENTATION AND POSSIBLE CONFIGURATIONS

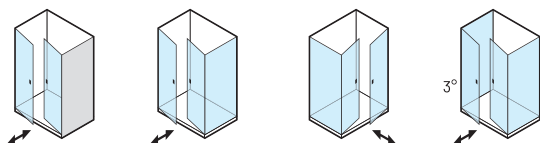

### PROFILI / PROFILES

STANDARD	
ULU	Brillantato Lucido Brilliant Polished
SAR	Satinato Argento Silver Glazed Satin
L01	Bianco Lucido Glossy White

In finitura SAR, componentistica e maniglia sono in finitura cromata  
In SAR finish, the components and handle are in a chrome finish

### VETRO / GLASS

STANDARD	
TR	Trasparente Transparent
ST	Stampato Printed
AS	Satinato Satin

ON DEMAND		
TE	Extrachiaro Extra Clear	TR +25%
TG	Trasparente Grigio Transparent Grey	TR +25%
GS	Satinato Grigio Satin Grey	TR +25%
RF	Fascia H.100cm Band H.100cm	TR +25%
SY	Specchio Mirror <sup>3</sup>	TR +50%

## PORTA / DOOR

L [cm]	COD.	A [cm]	B [cm]	C [cm]	[dm3]	[kg]	[Pcs]	V	ULU	SAR	L01
66-72	B7830	-	22,7	52	119	25	1	TR	675,00	675,00	565,00
								ST	745,00	745,00	620,00
								AS	845,00	845,00	705,00
72-78	B7831	-	25,7	58	141	28	1	TR	695,00	695,00	580,00
								ST	765,00	765,00	640,00
								AS	870,00	870,00	725,00
78-84	B7832	-	28,7	64	141	32	1	TR	720,00	720,00	600,00
								ST	790,00	790,00	660,00
								AS	900,00	900,00	750,00
86-92	B7833	-	32,7	72	155	34	1	TR	740,00	740,00	615,00
								ST	815,00	815,00	675,00
								AS	925,00	925,00	770,00
96-102	B7834	-	37,7	82	170	36	1	TR	760,00	760,00	635,00
								ST	835,00	835,00	700,00
								AS	950,00	950,00	795,00
106-112	B7835	-	42,7	92	186	38	1	TR	790,00	790,00	660,00
								ST	870,00	870,00	725,00
								AS	990,00	990,00	825,00
116-122	B7836	-	47,7	102	211	40	1	TR	815,00	815,00	680,00
								ST	895,00	895,00	750,00
								AS	1.020,00	1.020,00	850,00

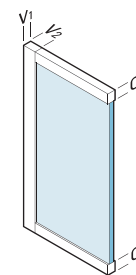

L	V1	V2	O1	O2
	47mm	45mm	45mm	45mm

## PARETE FISSA / FIXED PANEL

H. 200cm  
SP. 6mm

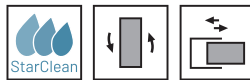

L1 [cm]	COD.	A [cm]	B [cm]	C [cm]	[dm3]	[kg]	[Pcs]	V	ULU	SAR	L01
67-70	B7824	-	-	-	121	24	1	TR	400,00	400,00	335,00
								ST	440,00	440,00	370,00
								AS	500,00	500,00	420,00
72-75	B7825	-	-	-	126	26	1	TR	425,00	425,00	355,00
								ST	470,00	470,00	390,00
								AS	530,00	530,00	445,00
77-80	B7826	-	-	-	130	28	1	TR	445,00	445,00	370,00
								ST	490,00	490,00	405,00
								AS	555,00	555,00	465,00
82-85	B7827	-	-	-	135	30	1	TR	470,00	470,00	390,00
								ST	515,00	515,00	430,00
								AS	590,00	590,00	490,00
87-90	B7828	-	-	-	142	31	1	TR	490,00	490,00	410,00
								ST	540,00	540,00	450,00
								AS	615,00	615,00	515,00
97-100	B7829	-	-	-	149	33	1	TR	520,00	520,00	435,00
								ST	570,00	570,00	480,00
								AS	650,00	650,00	545,00

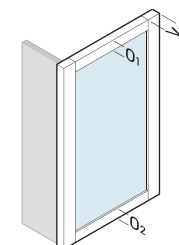

L1	V2	O1	O2
	45mm	45mm	45mm

SU MISURA/CUSTOM	PORTA DOOR	[€]	PARETE FISSA FIXED PANEL	[€]
Altezza/Height <sup>1</sup>	100-210cm	+20%	25-210cm	+20%
Larghezza/Width <sup>2</sup>	50-115cm	+20%	20-200cm	+20%
Altezza/Height Larghezza/Width <sup>2</sup>	100-210cm 50-115cm	+20%	25-210cm 20-200cm	+20%
Altre forme Other shapes <sup>2</sup>		+30%		+30%

OPTIONAL	COD.	[€]
Profilo compensazione Compensation Profile	L01	60,00
	ULU	90,00
	SAR	90,00
Maniglia / Handle 1pc	RIC1418LUC	75,00

<sup>1</sup> Dal prezzo della misura di riferimento / From the price of selected size

<sup>2</sup> Dal prezzo della misura superiore / From the price of the larger size

<sup>3</sup> Contattare l'ufficio clienti per informazioni / Contact the customer service office for information

DISPONIBILITA' A MAGAZZINO / STOCK AVAILABILITY

1/2 Settimane/Weeks

2/3 Settimane/Weeks

3/4 Settimane/Weeks

# EUROPA

PORTA SOFFIETTO  
FOLDING DOOR



Per istruzioni di montaggio  
e ricambi inquadra il codice QR  
For assembly instructions  
and spare parts, scan the QR code



**H. 200cm**  
**SP. 6mm**

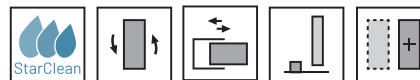

Parete doccia con due ante con apertura a soffietto. L'apertura delle ante è verso l'interno. Modello adatto per situazioni che necessitano di un ingresso ampio, ma con spazio di installazione limitato.

Shower enclosure with two folding doors. The doors open inward. This model is suitable for situations requiring a wide entrance, but with limited installation space.

**CONFIGURAZIONE IN NICCHIA**  
**NICHE CONFIGURATION**

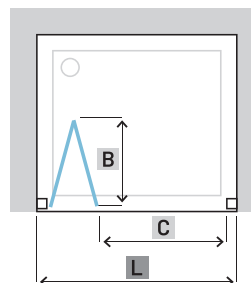

**CONFIGURAZIONE AD ANGOLO**  
**CORNER CONFIGURATION**

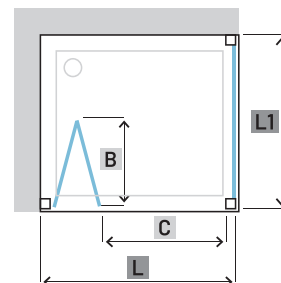

**CONFIGURAZIONE A TRE LATI**  
**THREE-SIDED CONFIGURATION**

Per le configurazioni a tre lati considerare la parete fissa (L1).  
For three-sided configurations, consider the fixed panel (L1).

## ORIENTAMENTO E POSSIBILI COMBINAZIONI / ORIENTATION AND POSSIBLE CONFIGURATIONS

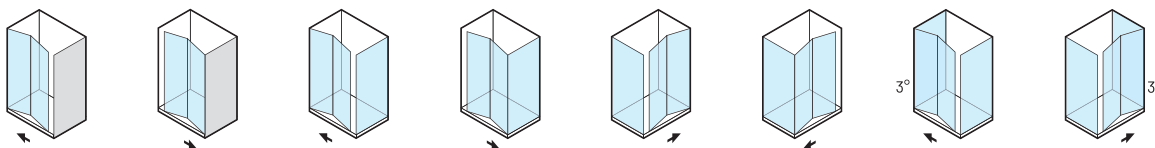

### PROFILI / PROFILES

STANDARD	
ULU	Brillantato Lucido Brilliant Polished
SAR	Satinato Argento Silver Glazed Satin
L01	Bianco Lucido Glossy White

In finitura SAR, componentistica e maniglia sono in finitura cromata  
In SAR finish, the components and handle are in a chrome finish

### VETRO / GLASS

STANDARD	
TR	Trasparente Transparent
ST	Stampato Printed
AS	Satinato Satin

ON DEMAND		
TE	Extrachiaro Extra Clear	TR +25%
TG	Trasparente Grigio Transparent Grey	TR +25%
GS	Satinato Grigio Satin Grey	TR +25%
RF	Fascia H.100cm Band H.100cm	TR +25%
SY	Specchio Mirror <sup>3</sup>	TR +50%

## PORTA / DOOR

L [cm]	COD.	A [cm]	B [cm]	C [cm]	[dm3]	[kg]	[Pcs]	V	ULU	SAR	L01
66-72	B7807	-	30	43	126	26	1	TR	890,00	890,00	740,00
								ST	980,00	980,00	815,00
								AS	1.115,00	1.115,00	925,00
72-78	B7808	-	33	49	139	30	1	TR	915,00	915,00	765,00
								ST	1.005,00	1.005,00	840,00
								AS	1.145,00	1.145,00	955,00
78-84	B7809	-	36	55	150	32	1	TR	945,00	945,00	790,00
								ST	1.040,00	1.040,00	870,00
								AS	1.180,00	1.180,00	990,00
86-92	B7810	-	40	63	164	34	1	TR	965,00	965,00	805,00
								ST	1.060,00	1.060,00	885,00
								AS	1.205,00	1.205,00	1.005,00
96-102	B7811	-	45	73	170	36	1	TR	995,00	995,00	830,00
								ST	1.095,00	1.095,00	915,00
								AS	1.245,00	1.245,00	1.040,00

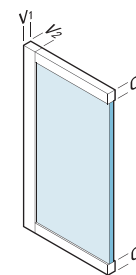

L	V1	V2	O1	O2
	47mm	45mm	45mm	45mm

## PARETE FISSA / FIXED PANEL

H. 200cm  
SP. 6mm

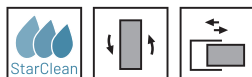

L1 [cm]	COD.	A [cm]	B [cm]	C [cm]	[dm3]	[kg]	[Pcs]	V	ULU	SAR	L01
67-70	B7824	-	-	-	121	24	1	TR	400,00	400,00	335,00
								ST	440,00	440,00	370,00
								AS	500,00	500,00	420,00
72-75	B7825	-	-	-	126	26	1	TR	425,00	425,00	355,00
								ST	470,00	470,00	390,00
								AS	530,00	530,00	445,00
77-80	B7826	-	-	-	130	28	1	TR	445,00	445,00	370,00
								ST	490,00	490,00	405,00
								AS	555,00	555,00	465,00
82-85	B7827	-	-	-	135	30	1	TR	470,00	470,00	390,00
								ST	515,00	515,00	430,00
								AS	590,00	590,00	490,00
87-90	B7828	-	-	-	142	31	1	TR	490,00	490,00	410,00
								ST	540,00	540,00	450,00
								AS	615,00	615,00	515,00
97-100	B7829	-	-	-	149	33	1	TR	520,00	520,00	435,00
								ST	570,00	570,00	480,00
								AS	650,00	650,00	545,00

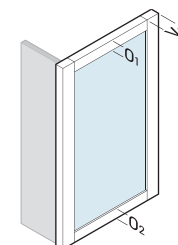

L1	V2	O1	O2
	45mm	45mm	45mm

SU MISURA/CUSTOM	PORTA DOOR	[€]	PARETE FISSA FIXED PANEL	[€]
Altezza/Height <sup>1</sup>	100-210cm	+20%	25-210cm	+20%
Larghezza/Width <sup>2</sup>	65-115cm	+20%	20-200cm	+20%
Altezza/Height Larghezza/Width <sup>2</sup>	100-210cm 65-115cm	+20%	25-210cm 20-200cm	+20%
Altre forme Other shapes <sup>2</sup>		+30%		+30%

OPTIONAL	COD.	[€]
Profilo compensazione Compensation Profile	L01	60,00
	COM10A (+3cm)	90,00
	SAR	90,00
Maniglia / Handle 1pc	RIC1418LUC	75,00

<sup>1</sup> Dal prezzo della misura di riferimento / From the price of selected size

<sup>2</sup> Dal prezzo della misura superiore / From the price of the larger size

<sup>3</sup> Contattare l'ufficio clienti per informazioni / Contact the customer service office for information

DISPONIBILITA' A MAGAZZINO / STOCK AVAILABILITY

1/2 Settimane/Weeks

2/3 Settimane/Weeks

3/4 Settimane/Weeks

# EUROPA

STONDATO PORTA SCORREVOLE  
CURVED SLIDING DOOR



Per istruzioni di montaggio  
e ricambi inquadra il codice QR  
For assembly instructions  
and spare parts, scan the QR code



H. 200cm  
SP. 6mm

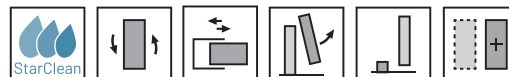

Parete doccia stondata disponibile in versioni per installazioni in angolo in dimensioni quadrate o rettangolari. Il modello dispone di due ante di cui una scorrevole apribile lateralmente.

Curved shower enclosure available in versions for corner installations, in square or rectangular dimensions. The model features two panels, one of which is a sliding door that opens sideways.

### CONFIGURAZIONE AD ANGOLO CORNER CONFIGURATION

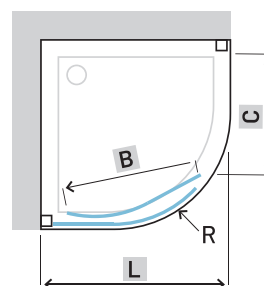

B7863 R 55cm  
B7862 R 55cm

### CONFIGURAZIONE A TRE LATI THREE-SIDED CONFIGURATION

Per le configurazioni a tre lati considerare la parete fissa (L1).  
For three-sided configurations, consider the fixed panel (L1).

### ORIENTAMENTO E POSSIBILI COMBINAZIONI / ORIENTATION AND POSSIBLE CONFIGURATIONS

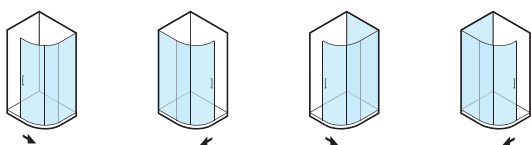

#### PROFILI / PROFILES

STANDARD	
ULU	Brillantato Lucido Brilliant Polished
L01	Bianco Lucido Glossy White

#### VETRO / GLASS

STANDARD	
TR	Trasparente Transparent
ST	Stampato Printed
AS	Satinato Satin

## PORTA / DOOR

L [cm]	COD.	A [cm]	B [cm]	C [cm]	[dm <sup>3</sup> ]	[kg]	[Pcs]	V	ULU	L01
76,5-79,5	B7863	-	57,3	45	369	50	2	TR	1.295,00	1.080,00
								ST	1.425,00	1.190,00
								AS	1.620,00	1.350,00
86,5-89,5	B7862	-	67	54	450	54	2	TR	1.365,00	1.140,00
								ST	1.500,00	1.255,00
								AS	1.705,00	1.425,00

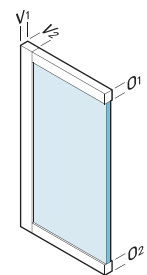

L	
V <sub>1</sub>	47mm
V <sub>2</sub>	45mm
O <sub>1</sub>	45mm
O <sub>2</sub>	45mm

## PARETE FISSA / FIXED PANEL

H. 200cm  
SP. 6mm

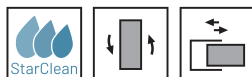

L1 [cm]	COD.	A [cm]	B [cm]	C [cm]	[dm <sup>3</sup> ]	[kg]	[Pcs]	V	ULU	L01
67-70	B7824	-	-	-	121	24	1	TR	400,00	335,00
								ST	440,00	370,00
								AS	500,00	420,00
72-75	B7825	-	-	-	126	26	1	TR	425,00	355,00
								ST	470,00	390,00
								AS	530,00	445,00
77-80	B7826	-	-	-	130	28	1	TR	445,00	370,00
								ST	490,00	405,00
								AS	555,00	465,00
82-85	B7827	-	-	-	135	30	1	TR	470,00	390,00
								ST	515,00	430,00
								AS	590,00	490,00
87-90	B7828	-	-	-	142	31	1	TR	490,00	410,00
								ST	540,00	450,00
								AS	615,00	515,00
97-100	B7829	-	-	-	149	33	1	TR	520,00	435,00
								ST	570,00	480,00
								AS	650,00	545,00

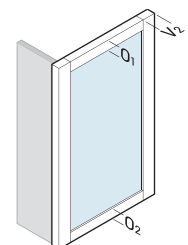

L1	
V <sub>2</sub>	45mm
O <sub>1</sub>	45mm
O <sub>2</sub>	45mm

SU MISURA/CUSTOM	PARETE FISSA FIXED PANEL	[€]
▲▼ Altezza/Height <sup>1</sup>	25-210cm	+20%
◀▶ Larghezza/Width <sup>2</sup>	20-200cm	+20%
◆ Altezza/Height Larghezza/Width <sup>2</sup>	25-210cm 20-200cm	+20%
Altre forme Other shapes <sup>2</sup>		+30%

OPTIONAL	COD.	[€]	
Profilo compensazione Compensation Profile	COM10A (+3cm)	L01	60,00
		ULU	90,00
		SAR	90,00
Maniglia / Handle 1pc	RIC1418LUC	ULU	75,00

DISPONIBILITA' A MAGAZZINO / STOCK AVAILABILITY

1/2 Settimane/Weeks    2/3 Settimane/Weeks    3/4 Settimane/Weeks

<sup>1</sup> Dal prezzo della misura di riferimento / From the price of selected size

<sup>2</sup> Dal prezzo della misura superiore / From the price of the larger size

# EUROPA

STONDATO DOPPIA PORTA SCORREVOLE  
CURVED DOUBLE SLIDING DOOR



Per istruzioni di montaggio  
e ricambi inquadra il codice QR  
For assembly instructions  
and spare parts, scan the QR code



**H. 200cm**  
**SP. 6mm**



Parete doccia stondata disponibile in versioni per installazioni in angolo in dimensioni quadrate o rettangolari. Il modello dispone di quattro ante di cui le due centrali apribili.

*Curved shower enclosure available in versions for corner installations in square or rectangular sizes. The model features four panels, with the two central ones being openable.*

### CONFIGURAZIONE AD ANGOLO CORNER CONFIGURATION

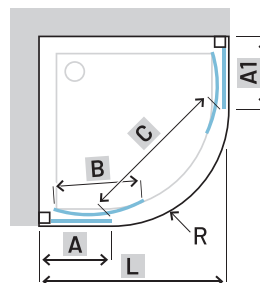

<b>B7853</b>	R 55cm
<b>B7852</b>	R 55cm
<b>B7854</b>	R 55cm
<b>B7893</b>	R 38cm
<b>B7895</b>	R 38cm

### CONFIGURAZIONE A TRE LATI THREE-SIDED CONFIGURATION

Per le configurazioni a tre lati considerare la parete fissa (L1).  
For three-sided configurations, consider the fixed panel (L1).

### ORIENTAMENTO E POSSIBILI COMBINAZIONI / ORIENTATION AND POSSIBLE CONFIGURATIONS

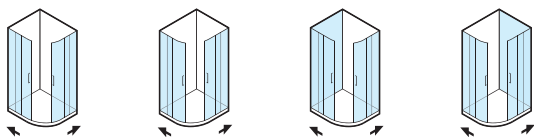

#### PROFILI / PROFILES

STANDARD	
<b>ULU</b>	Brillantato Lucido Brilliant Polished
<b>L01</b>	Bianco Lucido Glossy White

#### VETRO / GLASS

STANDARD	
<b>TR</b>	Trasparente Transparent
<b>ST</b>	Stampato Printed
<b>AS</b>	Satinato Satin

## PORTA / DOOR

L [cm]	COD.	A [cm]	A1 [cm]	B [cm]	C [cm]	[dm <sup>3</sup> ]	[kg]	[Pcs]	V	ULU	L01
76,5-79,5	B7853	22,5-25,5	22,5-25,5	41	39	249	50	2	TR	1.260,00	1.050,00
									ST	1.385,00	1.155,00
									AS	1.575,00	1.315,00
86,5-89,5	B7852	32,5-35,5	32,5-35,5	41	47	287	56	2	TR	1.325,00	1.105,00
									ST	1.460,00	1.215,00
									AS	1.655,00	1.380,00
96,5-99,5	B7854	42,5-45,5	42,5-45,5	41	47	346	63	2	TR	1.435,00	1.195,00
									ST	1.580,00	1.315,00
									AS	1.795,00	1.495,00
66,5-69,5 86,5-89,5	B7893	25,7-28,7	45,7-48,7	30,9	38	254	52	2	TR	1.325,00	1.105,00
									ST	1.460,00	1.215,00
									AS	1.655,00	1.380,00
76,5-79,5 96,5-99,5	B7895	35,7-38,7	55,7-58,7	30,9	38	308	58	2	TR	1.395,00	1.165,00
									ST	1.535,00	1.280,00
									AS	1.745,00	1.455,00

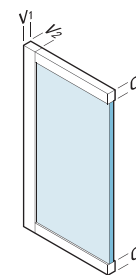

L	V1	V2	O1	O2
	47mm	45mm	45mm	45mm

## PARETE FISSA / FIXED PANEL

H. 200cm  
SP. 6mm

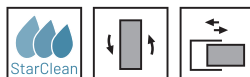

L1 [cm]	COD.	A [cm]	A1 [cm]	B [cm]	C [cm]	[dm <sup>3</sup> ]	[kg]	[Pcs]	V	ULU	L01
67-70	B7824	-	-	-	-	121	24	1	TR	400,00	335,00
									ST	440,00	370,00
									AS	500,00	420,00
72-75	B7825	-	-	-	-	126	26	1	TR	425,00	355,00
									ST	470,00	390,00
									AS	530,00	445,00
77-80	B7826	-	-	-	-	130	28	1	TR	445,00	370,00
									ST	490,00	405,00
									AS	555,00	465,00
82-85	B7827	-	-	-	-	135	30	1	TR	470,00	390,00
									ST	515,00	430,00
									AS	590,00	490,00
87-90	B7828	-	-	-	-	142	31	1	TR	490,00	410,00
									ST	540,00	450,00
									AS	615,00	515,00
97-100	B7829	-	-	-	-	149	33	1	TR	520,00	435,00
									ST	570,00	480,00
									AS	650,00	545,00

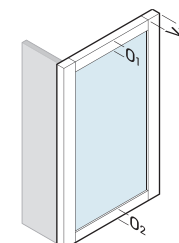

L1	V2	O1	O2
	45mm	45mm	45mm

SU MISURA/CUSTOM	PORTA DOOR	[€]	PARETE FISSA FIXED PANEL	[€]
Altezza/Height <sup>1</sup>	Vedi nota/See note <sup>3</sup>	-	25-210cm	+20%
Larghezza/Width <sup>2</sup>	Vedi nota/See note <sup>3</sup>	+20%	20-200cm	+20%
Altezza/Height Larghezza/Width <sup>2</sup>	Vedi nota/See note <sup>3</sup>	-	25-210cm 20-200cm	+20%
Altre forme Other shapes <sup>2</sup>		+30%		+30%

OPTIONAL	COD.	[€]
Profilo compensazione Compensation Profile	L01	60,00
	COM10A (+3cm)	90,00
	SAR	90,00
Maniglia / Handle 1pc	RIC1418LUC	75,00

<sup>1</sup> Dal prezzo della misura di riferimento / From the price of selected size

<sup>2</sup> Dal prezzo della misura superiore / From the price of the larger size

<sup>3</sup> Contattare l'ufficio clienti per informazioni / Contact the customer service office for information

DISPONIBILITA' A MAGAZZINO / STOCK AVAILABILITY

1/2 Settimane/Weeks

2/3 Settimane/Weeks

3/4 Settimane/Weeks

# EUROPA

PARETE FISSA  
FIXED PANEL



Per istruzioni di montaggio  
e ricambi inquadra il codice QR  
For assembly instructions  
and spare parts, scan the QR code



**H. 200cm**  
**SP. 6mm**

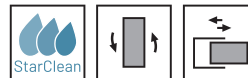

Parete fissa per abbinamenti. È possibile utilizzarla in abbinamento al modello di parete doccia selezionato per realizzare installazioni ad angolo o a tre lati quando possibile.

*Fixed panel for combinations. It can be used in combination with the selected shower enclosure model to create corner or three-sided installations where possible.*

### CONFIGURAZIONI IN ANGOLO ED A TRE LATI CORNER AND THREE-SIDED CONFIGURATIONS

È possibile realizzare configurazioni ad angolo ed a tre lati. Verificare le possibilità nelle pagine dei modelli specifici.

*It is possible to create corner and three-sided configurations; Check the options on the pages of the specific models.*

## ORIENTAMENTO E POSSIBILI COMBINAZIONI / ORIENTATION AND POSSIBLE CONFIGURATIONS

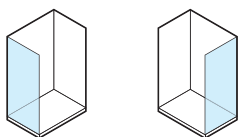

### PROFILI / PROFILES

STANDARD	
ULU	Brillantato Lucido <i>Brilliant Polished</i>
SAR	Satinato Argento <i>Silver Glazed Satin</i>
L01	Bianco Lucido <i>Glossy White</i>

In finitura SAR, componentistica e maniglia sono in finitura cromata  
*In SAR finish, the components and handle are in a chrome finish*

### VETRO / GLASS

STANDARD	
TR	Trasparente <i>Transparent</i>
ST	Stampato <i>Printed</i>
AS	Satinato <i>Satin</i>

ON DEMAND		
TE	Extrachiaro <i>Extra Clear</i>	TR +25%
TG	Trasparente Grigio <i>Transparent Grey</i>	TR +25%
GS	Satinato Grigio <i>Satin Grey</i>	TR +25%
RF	Fascia H.100cm <i>Band H.100cm</i>	TR +25%
SY	Specchio <i>Mirror<sup>3</sup></i>	TR +50%

**PARETE FISSA / FIXED PANEL**

L1 [cm]	COD.	A [cm]	B [cm]	H [cm]	[dm <sup>3</sup> ]	[kg]	[Pcs]	V	ULU	SAR	L01
67-70	B7824	-	-	200	121	24	1	TR	400,00	400,00	335,00
								ST	440,00	440,00	370,00
								AS	500,00	500,00	420,00
72-75	B7825	-	-	200	126	26	1	TR	425,00	425,00	355,00
								ST	470,00	470,00	390,00
								AS	530,00	530,00	445,00
77-80	B7826	-	-	200	130	28	1	TR	445,00	445,00	370,00
								ST	490,00	490,00	405,00
								AS	555,00	555,00	465,00
82-85	B7827	-	-	200	135	30	1	TR	470,00	470,00	390,00
								ST	515,00	515,00	430,00
								AS	590,00	590,00	490,00
87-90	B7828	-	-	200	142	31	1	TR	490,00	490,00	410,00
								ST	540,00	540,00	450,00
								AS	615,00	615,00	515,00
97-100	B7829	-	-	200	149	33	1	TR	520,00	520,00	435,00
								ST	570,00	570,00	480,00
								AS	650,00	650,00	545,00

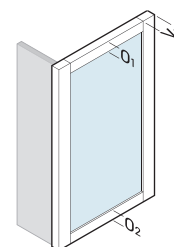

L1	V2	O1	O2
	45mm	45mm	45mm

SU MISURA/CUSTOM	PARETE FISSA FIXED PANEL	[€]
▲▼ Altezza/Height <sup>1</sup>	25-210cm	+20%
◀▶ Larghezza/Width <sup>2</sup>	20-200cm	+20%
◆ Altezza/Height Larghezza/Width <sup>2</sup>	25-210cm 20-200cm	+20%
Altre forme Other shapes <sup>2</sup>		+30%

OPTIONAL	COD.	[€]
Profilo compensazione Compensation Profile	L01	60,00
	COM10A (+3cm)	90,00
	SAR	90,00

<sup>1</sup> Dal prezzo della misura di riferimento / From the price of selected size

<sup>2</sup> Dal prezzo della misura superiore / From the price of the larger size

<sup>3</sup> Contattare l'ufficio clienti per informazioni / Contact the customer service office for information

**DISPONIBILITA' A MAGAZZINO / STOCK AVAILABILITY**

1/2 Settimane/Weeks	2/3 Settimane/Weeks	3/4 Settimane/Weeks
---------------------	---------------------	---------------------

# EUROPA SP















- > Parete doccia con telaio parziale
- > Vetro temperato 8mm per porte scorrevoli su configurazione ad angolo porte scorrevoli, 6mm per il resto della gamma
- > Trattamento anticalcare StarClean di serie incluso nel prezzo
- > Estensibilità e regolazione fuori squadra del muro fino a 2cm
- > Soft closing in chiusura sulle porte scorrevoli, compreso nel prezzo
- > Sgancio anta scorrevole per una agile pulizia del prodotto
- > Interasse maniglia 320 mm
- > Stampa digitale disponibile su tutti i vetri piani TR

- > Shower enclosure with partial frame
- > 8mm tempered glass for sliding doors in corner configurations, 6mm for the rest of the range
- > StarClean anti-limescale treatment included in the price
- > Wall adjustment and out-of-square compensation up to 2cm
- > Soft closing on sliding doors, included in the price
- > Detachable sliding door for easy product cleaning
- > Handle centre-to-centre distance 320 mm
- > Digital printing available on all flat glasses TR

# EUROPA SP

## PRODOTTI DELLA SERIE / PRODUCTS OF THE SERIES

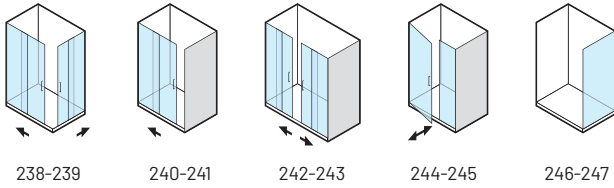

238-239

240-241

242-243

244-245

246-247

## PROFILI / PROFILES

### STANDARD



#### ULU

Brillantato Lucido  
Brilliant Polished

#### SAR

Satinato Argento  
Silver Glazed Satin

#### L01

Bianco Lucido  
Glossy White

## VETRO / GLASS

### STANDARD



#### TR

Trasparente  
Transparent

#### ST

Stampato  
Printed

#### AS

Satinato  
Satin

### ON DEMAND



#### TE

Extrachiaro  
Extra Clear

#### TG

Trasparente Grigio  
Transparent Grey

#### GS

Satinato Grigio  
Satin Grey

#### RF

Fascia H.100cm  
Band H.100cm

#### SY

Specchio  
Mirror

# EUROPA SP

LATO ANGOLO  
SIDE CORNER



Per istruzioni di montaggio  
e ricambi inquadra il codice QR  
For assembly instructions  
and spare parts, scan the QR code



**H. 200cm**  
**SP. 8mm (porta / door)**  
**SP. 6mm (fissa / fixed)**

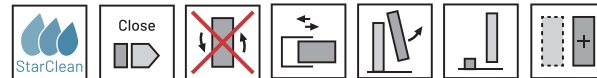

Parete doccia ad angolo a quattro ante, apertura ad ante scorrevoli nell'angolo del prodotto. Modello adatto per la maggior parte delle installazioni e disponibile in un'ampia gamma di dimensioni, soprattutto per chi vuole massimizzare le dimensioni d'ingresso.

*Corner shower wall with four panels, featuring sliding doors at the corner of the product. Suitable for most installations and available in a wide range of sizes, especially for those looking to maximize the entry dimensions.*

### CONFIGURAZIONE AD ANGOLO CORNER CONFIGURATION

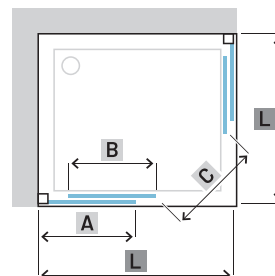

### CONFIGURAZIONE A TRE LATI THREE-SIDED CONFIGURATION

Per le configurazioni a tre lati considerare due volte la parete fissa (L1) specificando correttamente l'orientamento (destra o sinistra).  
*For three-sided configurations, consider the fixed panel (L1) twice, specifying the correct orientation (right or left).*

### ORIENTAMENTO E POSSIBILI COMBINAZIONI / ORIENTATION AND POSSIBLE CONFIGURATIONS

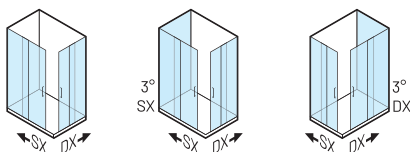

#### PROFILI/PROFILES

STANDARD	
ULU	Brillantato Lucido Brilliant Chrome
SAR	Satinato Argento Silver Glazed Satin
L01	Bianco Lucido Glossy White

In finitura SAR, componentistica e maniglia sono in finitura cromata  
*In SAR finish, the components and handle are in a chrome finish*

#### VETRO/GLASS

STANDARD	
TR	Trasparente Transparent
ST	Stampato Printed
AS	Satinato Satin

ON DEMAND		
TE	Extrachiaro Extra Clear	TR +25%
TG	Trasparente Grigio Transparent Grey	TR +25%
GS	Satinato Grigio Satin Grey	TR +25%
RF	Fascia H.100cm Band H.100cm	TR +25%
SY	Specchio Mirror <sup>3</sup>	TR +50%

## PORTA / DOOR

L [cm]	COD.	A [cm]	B [cm]	C [cm]	[dm <sup>3</sup> ]	[kg]	[Pcs]	V	ULU	SAR	L01
67-69	B7916	31,2-33,2	34,5	34	118	28	1	TR	650,00	595,00	545,00
								ST	715,00	655,00	600,00
								AS	815,00	745,00	680,00
72-74	B7917	33,7-35,7	37	37	128	30	1	TR	665,00	610,00	555,00
								ST	730,00	670,00	610,00
								AS	830,00	765,00	695,00
77-79	B7918	36,2-38,2	39,5	41	137	32	1	TR	680,00	625,00	570,00
								ST	750,00	690,00	625,00
								AS	850,00	780,00	715,00
82-84	B7919	38,7-40,7	42	44	145	34	1	TR	700,00	645,00	585,00
								ST	770,00	710,00	645,00
								AS	875,00	805,00	730,00
87-89	B7920	41,2-43,2	44,5	48	151	37	1	TR	715,00	655,00	595,00
								ST	785,00	720,00	655,00
								AS	895,00	820,00	745,00
97-99	B7921	51,2-53,2	44,5	48	168	41	1	TR	750,00	690,00	625,00
								ST	825,00	760,00	690,00
								AS	940,00	865,00	780,00
107-109	B7922	61,2-63,2	44,5	48	184	44	1	TR	785,00	720,00	655,00
								ST	865,00	790,00	720,00
								AS	980,00	900,00	820,00
117-119	B7923	71,2-73,2	44,5	48	201	47	1	TR	820,00	755,00	685,00
								ST	900,00	830,00	755,00
								AS	1.025,00	945,00	855,00

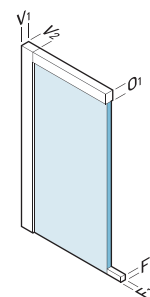

L	V1	V2	O1	F1	F2
	28mm	45mm	45mm	10mm	10mm

I valori della tabella prezzi si riferiscono ad un singolo lato: sommare l'importo dei due codici della misura desiderata per ottenere il prezzo totale di una doccia ad angolo quadrata o rettangolare. Apertura (C) determinata con due lati della stessa misura. Specificare il verso di apertura della parete doccia (/SX o /DX).

The prices in the table refer to a single side: add the amounts of the two codes for the desired size to get the total price of a square or rectangular corner shower. Opening (C) is determined by two sides of the same size. Specify the opening direction of the shower enclosure (/SX or /DX).

## PARETE FISSA / FIXED PANEL

H. 196,5cm  
SP. 6mm



L1 [cm]	COD.	A [cm]	B [cm]	C [cm]	[dm <sup>3</sup> ]	[kg]	[Pcs]	V	ULU	SAR	L01
67-69	B7924	-	-	-	121	24	1	TR	440,00	405,00	365,00
								ST	485,00	445,00	400,00
								AS	550,00	505,00	455,00
72-74	B7925	-	-	-	126	26	1	TR	465,00	425,00	385,00
								ST	510,00	470,00	425,00
								AS	580,00	530,00	480,00
77-79	B7926	-	-	-	130	28	1	TR	485,00	445,00	405,00
								ST	535,00	490,00	445,00
								AS	605,00	555,00	505,00
82-84	B7927	-	-	-	135	30	1	TR	515,00	470,00	430,00
								ST	565,00	515,00	475,00
								AS	645,00	590,00	540,00
87-89	B7928	-	-	-	142	31	1	TR	540,00	495,00	450,00
								ST	595,00	545,00	495,00
								AS	675,00	620,00	565,00
97-99	B7929	-	-	-	149	33	1	TR	565,00	520,00	475,00
								ST	620,00	570,00	525,00
								AS	705,00	650,00	595,00

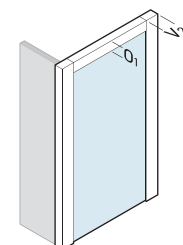

L1	V2	O1
	45mm	45mm

SU MISURA/CUSTOM	PORTA DOOR	[€]	PARETE FISSA FIXED PANEL	[€]
Altezza/Height <sup>1</sup>	50-210cm	+20%	200cm	+20%
Larghezza/Width <sup>2</sup>	50-135cm	+20%	20-120cm	+20%
Altezza/Height	50-210cm	+20%	200cm	+20%
Larghezza/Width <sup>2</sup>	50-135cm	+20%	20-120cm	+20%
Altre forme Other shapes <sup>2</sup>		+30%		+30%

OPTIONAL	COD.	[€]
Profilo compensazione Compensation Profile	COM10B (+3cm)	60,00
	L01	60,00
	ULU	90,00
	SAR	90,00
Maniglia/Handle 1Pcs	RIC1418LUC	75,00
	ULU	75,00

<sup>1</sup> Dal prezzo della misura di riferimento /From the price of selected size

<sup>2</sup> Dal prezzo della misura superiore /From the price of the larger size

<sup>3</sup> Contattare l'ufficio clienti per informazioni / Contact the customer service office for information

DISPONIBILITA' A MAGAZZINO/STOCK AVAILABILITY

1/2 Settimane/Weeks

2/3 Settimane/Weeks

3/4 Settimane/Weeks

# EUROPA SP

PORTA SCORREVOLE  
SLIDING DOOR



Per istruzioni di montaggio  
e ricambi inquadra il codice QR  
For assembly instructions  
and spare parts, scan the QR code



**H. 196,5cm**  
**SP. 6mm**

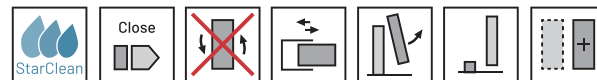

Parete doccia a due ante con apertura laterale scorrevole. Modello adatto per la maggior parte delle installazioni e disponibile in un'ampia gamma di dimensioni.

Shower wall with two panels and side sliding opening. Suitable for most installations and available in a wide range of sizes.

**CONFIGURAZIONE IN NICCHIA**  
**NICHE CONFIGURATION**

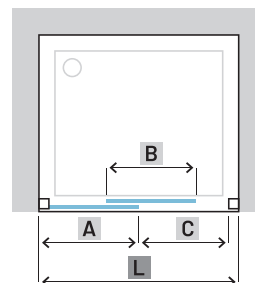

**CONFIGURAZIONE AD ANGOLO**  
**CORNER CONFIGURATION**

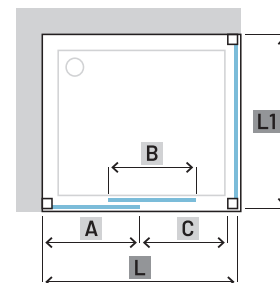

**CONFIGURAZIONE A TRE LATI**  
**THREE-SIDED CONFIGURATION**

Per le configurazioni a tre lati considerare due volte la parete fissa (L1) specificando correttamente l'orientamento (destra o sinistra).  
For three-sided configurations, consider the fixed panel (L1) twice, specifying the correct orientation (right or left).

## ORIENTAMENTO E POSSIBILI COMBINAZIONI / ORIENTATION AND POSSIBLE CONFIGURATIONS

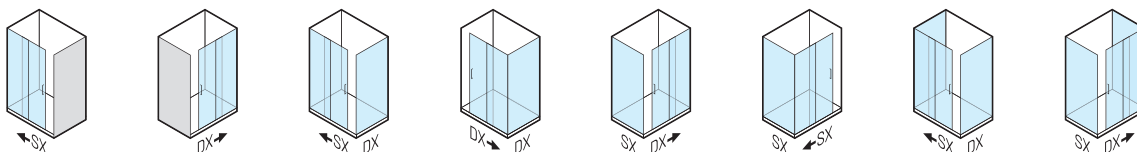

### PROFILI/PROFILES

STANDARD	
ULU	Brillantato Lucido Brilliant Chrome
SAR	Satinato Argento Silver Glazed Satin
L01	Bianco Lucido Glossy White

In finitura SAR, componentistica e maniglia sono in finitura cromata  
In SAR finish, the components and handle are in a chrome finish

### VETRO/GLASS

STANDARD	
TR	Trasparente Transparent
ST	Stampato Printed
AS	Satinato Satin

ON DEMAND		
TE	Extrachiaro Extra Clear	TR +25%
TG	Trasparente Grigio Transparent Grey	TR +25%
GS	Satinato Grigio Satin Grey	TR +25%
RF	Fascia H.100cm Band H.100cm	TR +25%
SY	Specchio Mirror <sup>3</sup>	TR +50%

## PORTA / DOOR

L [cm]	COD.	A [cm]	B [cm]	C [cm]	[dm <sup>3</sup> ]	[kg]	[Pcs]	V	ULU	SAR	L01
96-101	B7980	45,7-48	46,9	36	121	37	1	TR	880,00	805,00	735,00
								ST	970,00	885,00	810,00
								AS	1.100,00	1.005,00	920,00
103-108	B7981	49-51,5	50,4	40	130	39	1	TR	905,00	830,00	755,00
								ST	995,00	915,00	830,00
								AS	1.130,00	1.040,00	945,00
110-115	B7982	52,5-55	53,9	43	137	40	1	TR	930,00	855,00	775,00
								ST	1.025,00	940,00	855,00
								AS	1.165,00	1.070,00	970,00
116-121	B7983	55,7-58	56,9	46	145	42	1	TR	955,00	875,00	795,00
								ST	1.050,00	965,00	875,00
								AS	1.195,00	1.095,00	995,00
123-128	B7984	59-61,5	60,4	50	156	44	1	TR	980,00	900,00	820,00
								ST	1.080,00	990,00	900,00
								AS	1.225,00	1.125,00	1.025,00
130-135	B7985	62,5-65	63,9	53	158	46	1	TR	1.005,00	925,00	840,00
								ST	1.105,00	1.020,00	925,00
								AS	1.255,00	1.155,00	1.050,00
136-141	B7986	65,5-68	66,9	56	260	51	2	TR	1.035,00	950,00	865,00
								ST	1.140,00	1.045,00	950,00
								AS	1.295,00	1.190,00	1.080,00
145-150	B7987	70-72,5	71,4	61	265	52	2	TR	1.065,00	975,00	885,00
								ST	1.170,00	1.075,00	975,00
								AS	1.330,00	1.220,00	1.105,00
152-157	B7988	73,7-76	74,9	64	273	54	2	TR	1.095,00	1.005,00	915,00
								ST	1.205,00	1.105,00	1.005,00
								AS	1.370,00	1.255,00	1.145,00
159-164	B7989	77-79,5	78,4	68	286	57	2	TR	1.120,00	1.030,00	940,00
								ST	1.230,00	1.135,00	1.035,00
								AS	1.400,00	1.290,00	1.175,00
166-171	B7990	80,5-83	81,9	71	294	60	2	TR	1.155,00	1.060,00	965,00
								ST	1.270,00	1.165,00	1.060,00
								AS	1.445,00	1.325,00	1.205,00
173-178	B7991	84-86,5	85,4	75	302	63	2	TR	1.185,00	1.090,00	990,00
								ST	1.305,00	1.200,00	1.090,00
								AS	1.480,00	1.365,00	1.240,00

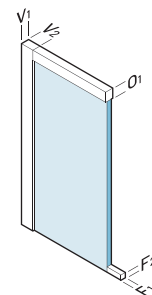

L
V <sub>1</sub> 47mm
V <sub>2</sub> 45mm
O <sub>1</sub> 45mm
F <sub>1</sub> 10mm
F <sub>2</sub> 10mm

## PARETE FISSA / FIXED PANEL

H. 196,5cm  
SP. 6mm



L1 [cm]	COD.	A [cm]	B [cm]	C [cm]	[dm <sup>3</sup> ]	[kg]	[Pcs]	V	ULU	SAR	L01
67-69	B7924	-	-	-	121	24	1	TR	440,00	405,00	365,00
								ST	485,00	445,00	400,00
								AS	550,00	505,00	455,00
72-74	B7925	-	-	-	126	26	1	TR	465,00	425,00	385,00
								ST	510,00	470,00	425,00
								AS	580,00	530,00	480,00
77-79	B7926	-	-	-	130	28	1	TR	485,00	445,00	405,00
								ST	535,00	490,00	445,00
								AS	605,00	555,00	505,00
82-84	B7927	-	-	-	135	30	1	TR	515,00	470,00	430,00
								ST	565,00	515,00	475,00
								AS	645,00	590,00	540,00
87-89	B7928	-	-	-	142	31	1	TR	540,00	495,00	450,00
								ST	595,00	545,00	495,00
								AS	675,00	620,00	565,00
97-99	B7929	-	-	-	149	33	1	TR	565,00	520,00	475,00
								ST	620,00	570,00	525,00
								AS	705,00	650,00	595,00

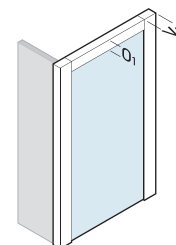

L1
V <sub>2</sub> 45mm
O <sub>1</sub> 45mm

SU MISURA/CUSTOM	PORTA DOOR	[€]	PARETE FISSA FIXED PANEL	[€]
Altezza/Height <sup>1</sup>	50-210cm	+20%	50-210cm	+20%
Larghezza/Width <sup>2</sup>	80-190cm	+20%	20-120cm	+20%
Altezza/Height Larghezza/Width <sup>2</sup>	50-210cm 80-190cm	+20%	50-210cm 20-120cm	+20%
Altre forme Other shapes <sup>2</sup>		+30%		+30%

OPTIONAL	COD.	[€]
Profilo compensazione Compensation Profile	L01	60,00
	ULU	90,00
	SAR	90,00
Maniglia/Handle 1Pcs	RIC1418LUC	75,00

<sup>1</sup> Dal prezzo della misura di riferimento / From the price of selected size

<sup>2</sup> Dal prezzo della misura superiore / From the price of the larger size

<sup>3</sup> Contattare l'ufficio clienti per informazioni / Contact the customer service office for information

DISPONIBILITA' A MAGAZZINO / STOCK AVAILABILITY

1/2 Settimane/Weeks 2/3 Settimane/Weeks 3/4 Settimane/Weeks

# EUROPA SP

DOPPIA PORTA SCORREVOLE  
DOUBLE SLIDING DOORS



Per istruzioni di montaggio  
e ricambi inquadra il codice QR  
For assembly instructions  
and spare parts, scan the QR code

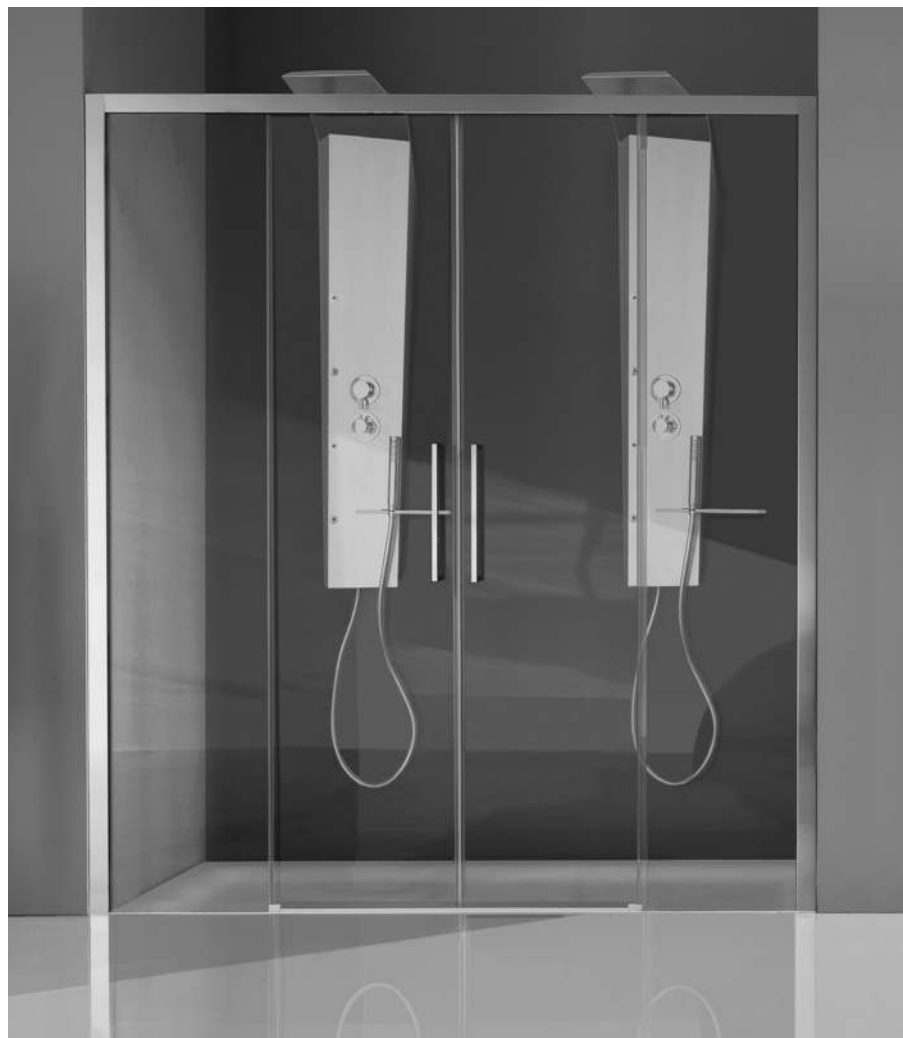

H. 196,5cm  
SP. 6mm

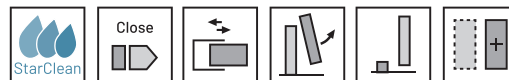

Parete doccia a quattro ante con apertura centrale. L'apertura è centrale data dalle due ante centrali scorrevoli in modo contrapposto. Modello adatto per installazioni di generose dimensioni.

Shower enclosure with four panels and a central opening. The opening is created by the two central sliding doors, which move in opposite directions. This model is suitable for large-scale installations.

CONFIGURAZIONE IN NICCHIA  
NICHE CONFIGURATION

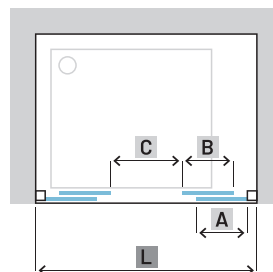

CONFIGURAZIONE AD ANGOLO  
CORNER CONFIGURATION

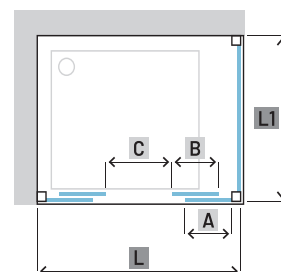

CONFIGURAZIONE A TRE LATI  
THREE-SIDED CONFIGURATION

Per le configurazioni a tre lati considerare due volte la parete fissa (L1) specificando correttamente l'orientamento (destra o sinistra).  
For three-sided configurations, consider the fixed panel (L1) twice, specifying the correct orientation (right or left).

## ORIENTAMENTO E POSSIBILI COMBINAZIONI / ORIENTATION AND POSSIBLE CONFIGURATIONS

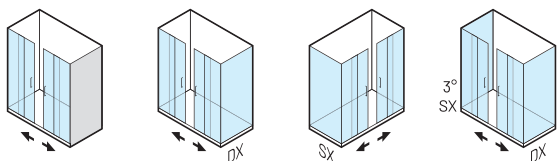

### PROFILI/PROFILES

STANDARD	
ULU	Brillantato Lucido Brilliant Chrome
SAR	Satinato Argento Silver Glazed Satin
L01	Bianco Lucido Glossy White

In finitura SAR, componentistica e maniglia sono in finitura cromata  
In SAR finish, the components and handle are in a chrome finish

### VETRO/GLASS

STANDARD	
TR	Trasparente Transparent
ST	Stampato Printed
AS	Satinato Satin

ON DEMAND		
TE	Extrachiaro Extra Clear	TR +25%
TG	Trasparente Grigio Transparent Grey	TR +25%
GS	Satinato Grigio Satin Grey	TR +25%
RF	Fascia H.100cm Band H.100cm	TR +25%
SY	Specchio Mirror <sup>3</sup>	TR +50%

## PORTA / DOOR

L [cm]	COD.	A [cm]	B [cm]	C [cm]	[dm3]	[kg]	[Pcs]	V	ULU	SAR	L01
136-141	B7944	33,7 - 36,2	36,5	53	169	53	2	TR	1.235,00	1.135,00	1.030,00
								ST	1.360,00	1.250,00	1.135,00
								AS	1.545,00	1.420,00	1.290,00
146-151	B7945	36,2 - 38,7	39	58	178	57	2	TR	1.260,00	1.160,00	1.055,00
								ST	1.385,00	1.275,00	1.160,00
								AS	1.575,00	1.450,00	1.320,00
156-161	B7946	38,7 - 41,2	41,5	63	181	58	2	TR	1.290,00	1.180,00	1.080,00
								ST	1.420,00	1.300,00	1.190,00
								AS	1.615,00	1.475,00	1.350,00
166-171	B7947	41,2 - 43,7	44	68	192	61	2	TR	1.315,00	1.210,00	1.100,00
								ST	1.445,00	1.330,00	1.210,00
								AS	1.645,00	1.515,00	1.375,00
176-181	B7948	43,7 - 46,2	46,5	73	200	63	2	TR	1.350,00	1.235,00	1.120,00
								ST	1.485,00	1.360,00	1.230,00
								AS	1.690,00	1.545,00	1.400,00

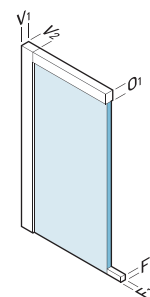

L
V <sub>1</sub> 47mm
V <sub>2</sub> 45mm
O <sub>1</sub> 45mm
F <sub>1</sub> 10mm
F <sub>2</sub> 10mm

## PARETE FISSA / FIXED PANEL

H. 196,5cm  
SP. 6mm



L1 [cm]	COD.	A [cm]	B [cm]	C [cm]	[dm3]	[kg]	[Pcs]	V	ULU	SAR	L01
67-69	B7924	-	-	-	121	24	1	TR	440,00	405,00	365,00
								ST	485,00	445,00	400,00
								AS	550,00	505,00	455,00
72-74	B7925	-	-	-	126	26	1	TR	465,00	425,00	385,00
								ST	510,00	470,00	425,00
								AS	580,00	530,00	480,00
77-79	B7926	-	-	-	130	28	1	TR	485,00	445,00	405,00
								ST	535,00	490,00	445,00
								AS	605,00	555,00	505,00
82-84	B7927	-	-	-	135	30	1	TR	515,00	470,00	430,00
								ST	565,00	515,00	475,00
								AS	645,00	590,00	540,00
87-89	B7928	-	-	-	142	31	1	TR	540,00	495,00	450,00
								ST	595,00	545,00	495,00
								AS	675,00	620,00	565,00
97-99	B7929	-	-	-	149	33	1	TR	565,00	520,00	475,00
								ST	620,00	570,00	525,00
								AS	705,00	650,00	595,00

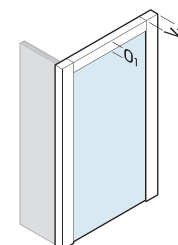

L1
V <sub>2</sub> 45mm
O <sub>1</sub> 45mm

SU MISURA/CUSTOM	PORTA DOOR	[€]	PARETE FISSA FIXED PANEL	[€]
Altezza/Height <sup>1</sup>	50-210cm	+20%	50-210cm	+20%
Larghezza/Width <sup>2</sup>	100-200cm	+20%	20-120cm	+20%
Altezza/Height	50-210cm	+20%	50-210cm	+20%
Larghezza/Width <sup>2</sup>	100-200cm	+20%	20-120cm	+20%
Altre forme Other shapes <sup>2</sup>		+30%		+30%

OPTIONAL	COD.	[€]
Profilo compensazione Compensation Profile	L01	60,00
	ULU	90,00
	SAR (+3cm)	90,00
Maniglia/Handle 1Pcs	RIC1418LUC	75,00

<sup>1</sup> Dal prezzo della misura di riferimento / From the price of selected size

<sup>2</sup> Dal prezzo della misura superiore / From the price of the larger size

<sup>3</sup> Contattare l'ufficio clienti per informazioni / Contact the customer service office for information

DISPONIBILITA' A MAGAZZINO/STOCK AVAILABILITY

1/2 Settimane/Weeks

2/3 Settimane/Weeks

3/4 Settimane/Weeks

# EUROPA SP

PORTA BATTENTE SU FISSO IN LINEA  
HINGED DOOR ON FIXED INLINE PANEL



Per istruzioni di montaggio  
e ricambi inquadra il codice QR  
For assembly instructions  
and spare parts, scan the QR code



H. 196,5cm  
SP. 6mm

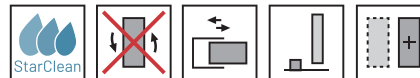

Parete doccia con apertura a porta battente su parete fissa in linea. L'apertura dell'anta è sia verso l'interno che verso l'esterno. Modello ad alto impatto estetico e disponibile in dimensioni maggiori rispetto ad una tradizionale porta.

Shower enclosure with a hinged door on a fixed inline panel. The door opens both inward and outward. A model with high aesthetic impact and available in larger sizes compared to a traditional door.

CONFIGURAZIONE IN NICCHIA  
NICHE CONFIGURATION

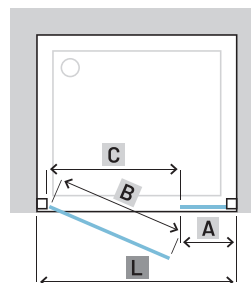

CONFIGURAZIONE AD ANGOLO  
CORNER CONFIGURATION

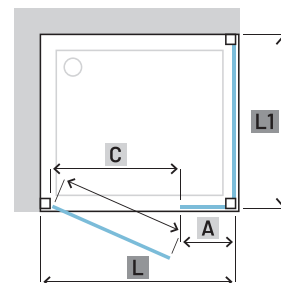

CONFIGURAZIONE A TRE LATI  
THREE-SIDED CONFIGURATION

Per le configurazioni a tre lati considerare due volte la parete fissa (L1) specificando correttamente l'orientamento (destra o sinistra).  
For three-sided configurations, consider the fixed panel (L1) twice, specifying the correct orientation (right or left).

## ORIENTAMENTO E POSSIBILI COMBINAZIONI / ORIENTATION AND POSSIBLE CONFIGURATIONS

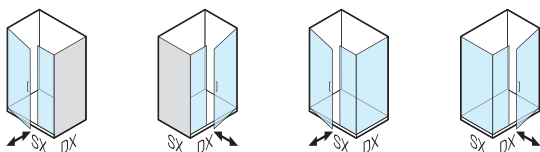

### PROFILI/PROFILES

STANDARD	
ULU	Brillantato Lucido Brilliant Chrome
SAR	Satinato Argento Silver Glazed Satin
L01	Bianco Lucido Glossy White

In finitura SAR, componentistica e maniglia sono in finitura cromata  
In SAR finish, the components and handle are in a chrome finish

### VETRO/GLASS

STANDARD	
TR	Trasparente Transparent
ST	Stampato Printed
AS	Satinato Satin

ON DEMAND		
TE	Extrachiaro Extra Clear	TR +25%
TG	Trasparente Grigio Transparent Grey	TR +25%
GS	Satinato Grigio Satin Grey	TR +25%
RF	Fascia H.100cm Band H.100cm	TR +25%
SY	Specchio Mirror <sup>3</sup>	TR +50%

## PORTA / DOOR

L [cm]	COD.	A [cm]	B [cm]	C [cm]	[dm <sup>3</sup> ]	[kg]	[Pcs]	V	ULU	SAR	L01
96-101	B7970	35,1-37,6	53,8	52	121	37	1	TR	1.045,00	960,00	875,00
								ST	1.150,00	1.055,00	965,00
								AS	1.305,00	1.200,00	1.095,00
106-111	B7971	33,1-35,6	65,8	64	137	40	1	TR	1.075,00	985,00	895,00
								ST	1.185,00	1.085,00	985,00
								AS	1.345,00	1.230,00	1.120,00
116-121	B7972	35,1-37,6	73,8	72	145	42	2	TR	1.105,00	1.010,00	920,00
								ST	1.215,00	1.110,00	1.010,00
								AS	1.380,00	1.265,00	1.150,00
126-131	B7973	45,1-47,6	73,8	72	158	46	2	TR	1.135,00	1.040,00	945,00
								ST	1.250,00	1.145,00	1.040,00
								AS	1.420,00	1.300,00	1.180,00
136-141	B7974	55,1-57,6	73,8	72	260	51	2	TR	1.165,00	1.065,00	970,00
								ST	1.280,00	1.170,00	1.065,00
								AS	1.455,00	1.330,00	1.215,00
146-151	B7975	65,1-67,6	73,8	72	265	52	2	TR	1.195,00	1.095,00	1.000,00
								ST	1.315,00	1.205,00	1.100,00
								AS	1.495,00	1.370,00	1.250,00
156-161	B7976	75,1-77,6	73,8	72	286	57	2	TR	1.230,00	1.125,00	1.030,00
								ST	1.355,00	1.240,00	1.135,00
								AS	1.540,00	1.405,00	1.290,00
166-171	B7977	85,1-87,6	73,8	72	294	60	2	TR	1.260,00	1.160,00	1.055,00
								ST	1.385,00	1.275,00	1.160,00
								AS	1.575,00	1.450,00	1.320,00

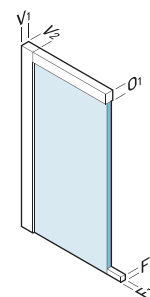

L
V <sub>1</sub> 47mm
V <sub>2</sub> 45mm
O <sub>1</sub> 45mm
F <sub>1</sub> 10mm
F <sub>2</sub> 10mm

## PARETE FISSA / FIXED PANEL

H. 196,5cm  
SP. 6mm



L1 [cm]	COD.	A [cm]	B [cm]	C [cm]	[dm <sup>3</sup> ]	[kg]	[Pcs]	V	ULU	SAR	L01
67-69	B7924	-	-	-	121	24	1	TR	440,00	405,00	365,00
								ST	485,00	445,00	400,00
								AS	550,00	505,00	455,00
72-74	B7925	-	-	-	126	26	1	TR	465,00	425,00	385,00
								ST	510,00	470,00	425,00
								AS	580,00	530,00	480,00
77-79	B7926	-	-	-	130	28	1	TR	485,00	445,00	405,00
								ST	535,00	490,00	445,00
								AS	605,00	555,00	505,00
82-84	B7927	-	-	-	135	30	1	TR	515,00	470,00	430,00
								ST	565,00	515,00	475,00
								AS	645,00	590,00	540,00
87-89	B7928	-	-	-	142	31	1	TR	540,00	495,00	450,00
								ST	595,00	545,00	495,00
								AS	675,00	620,00	565,00
97-99	B7929	-	-	-	149	33	1	TR	565,00	520,00	475,00
								ST	620,00	570,00	525,00
								AS	705,00	650,00	595,00

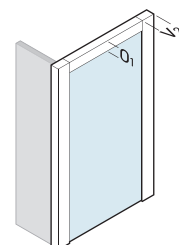

L1
V <sub>2</sub> 45mm
O <sub>1</sub> 45mm

SU MISURA/CUSTOM	PORTA DOOR	[€]	PARETE FISSA FIXED PANEL	[€]
Altezza/Height <sup>1</sup>	50-210cm	+20%	50-210cm	+20%
Larghezza/Width <sup>2</sup>	80-200cm	+20%	20-120cm	+20%
Altezza/Height Larghezza/Width <sup>2</sup>	50-210cm 80-200cm	+20%	50-210cm 20-120cm	+20%
Altre forme Other shapes <sup>2</sup>		+30%		+30%

OPTIONAL	COD.	[€]
Profilo compensazione Compensation Profile	L01	60,00
	ULU	90,00
	SAR	90,00
Maniglia/Handle 1Pcs	RIC1418LUC	75,00

<sup>1</sup> Dal prezzo della misura di riferimento / From the price of selected size

<sup>2</sup> Dal prezzo della misura superiore / From the price of the larger size

<sup>3</sup> Contattare l'ufficio clienti per informazioni / Contact the customer service office for information

DISPONIBILITA' A MAGAZZINO / STOCK AVAILABILITY

1/2 Settimane/Weeks

2/3 Settimane/Weeks

3/4 Settimane/Weeks

# EUROPA SP

PARETE FISSA  
FIXED PANEL



Per istruzioni di montaggio  
e ricambi inquadra il codice QR  
For assembly instructions  
and spare parts, scan the QR code



**H. 196,5cm**  
**SP. 6mm**

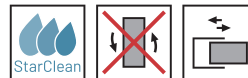

Parete fissa per abbinamenti. È possibile utilizzarla in abbinamento al modello di parete doccia selezionato per realizzare installazioni ad angolo o a tre lati quando possibile.

*Fixed panel for combinations. It can be used in combination with the selected shower enclosure model to create corner or three-sided installations where possible.*

### CONFIGURAZIONI IN ANGOLO ED A TRE LATI CORNER AND THREE-SIDED CONFIGURATIONS

È possibile realizzare configurazioni ad angolo ed a tre lati. Verificare le possibilità nelle pagine dei modelli specifici.

*It is possible to create corner and three-sided configurations; Check the options on the pages of the specific models.*

## ORIENTAMENTO E POSSIBILI COMBINAZIONI / ORIENTATION AND POSSIBLE CONFIGURATIONS

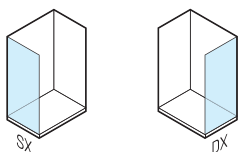

### PROFILI/PROFILES

STANDARD	
<b>ULU</b>	Brillantato Lucido <i>Brilliant Chrome</i>
<b>SAR</b>	Satinato Argento <i>Silver Glazed Satin</i>
<b>L01</b>	Bianco Lucido <i>Glossy White</i>

In finitura SAR, componentistica e maniglia sono in finitura cromata  
*In SAR finish, the components and handle are in a chrome finish*

### VETRO/GLASS

STANDARD	
<b>TR</b>	Trasparente <i>Transparent</i>
<b>ST</b>	Stampato <i>Printed</i>
<b>AS</b>	Satinato <i>Satin</i>

ON DEMAND		
<b>TE</b>	Extrachiaro <i>Extra Clear</i>	TR +25%
<b>TG</b>	Trasparente Grigio <i>Transparent Grey</i>	TR +25%
<b>GS</b>	Satinato Grigio <i>Satin Grey</i>	TR +25%
<b>RF</b>	Fascia H.100cm <i>Band H.100cm</i>	TR +25%
<b>SY</b>	Specchio <i>Mirror<sup>3</sup></i>	TR +50%

**PARETE FISSA / FIXED PANEL**

L1 [cm]	COD.	A [cm]	B [cm]	C [cm]	[dm <sup>3</sup> ]	[kg]	[Pcs]	V	ULU	SAR	L01
67-69	B7924	-	-	-	121	24	1	TR	440,00	405,00	365,00
								ST	485,00	445,00	400,00
								AS	550,00	505,00	455,00
72-74	B7925	-	-	-	126	26	1	TR	465,00	425,00	385,00
								ST	510,00	470,00	425,00
								AS	580,00	530,00	480,00
77-79	B7926	-	-	-	130	28	1	TR	485,00	445,00	405,00
								ST	535,00	490,00	445,00
								AS	605,00	555,00	505,00
82-84	B7927	-	-	-	135	30	1	TR	515,00	470,00	430,00
								ST	565,00	515,00	475,00
								AS	645,00	590,00	540,00
87-89	B7928	-	-	-	142	31	1	TR	540,00	495,00	450,00
								ST	595,00	545,00	495,00
								AS	675,00	620,00	565,00
97-99	B7929	-	-	-	149	33	1	TR	565,00	520,00	475,00
								ST	620,00	570,00	525,00
								AS	705,00	650,00	595,00

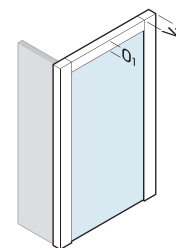

L1	V2	O1
	45mm	45mm

SU MISURA/CUSTOM	PARETE FISSA FIXED PANEL	[€]
▲▼ Altezza/Height <sup>1</sup>	50-210cm	+20%
◀▶ Larghezza/Width <sup>2</sup>	20-120cm	+20%
◆ Altezza/Height Larghezza/Width <sup>2</sup>	50-210cm 20-120cm	+20%
Altre forme Other shapes <sup>2</sup>		+30%

OPTIONAL	COD.	[€]
Profilo compensazione Compensation Profile	L01	60,00
	COM10B (+3cm)	90,00
	SAR	90,00

<sup>1</sup> Dal prezzo della misura di riferimento / From the price of selected size

<sup>2</sup> Dal prezzo della misura superiore / From the price of the larger size

<sup>3</sup> Contattare l'ufficio clienti per informazioni / Contact the customer service office for information

**DISPONIBILITA' A MAGAZZINO/STOCK AVAILABILITY**
**1/2** Settimane/Weeks

**2/3** Settimane/Weeks

**3/4** Settimane/Weeks

# CEE ART











- > Parete doccia con telaio
- > Vetro temperato 6mm per tutta la gamma
- > Trattamento anticalcare StarClean disponibile su richiesta
- > Estensibilità e regolazione fuori squadra del muro fino a 2cm
- > Sgancio anta scorrevole per una agile pulizia del prodotto
- > Interasse maniglia 160mm
- > Stampa digitale disponibile su tutti i vetri piani TR

- > Shower enclosure with frame
- > 6mm tempered glass across the entire range
- > StarClean anti-limescale treatment available upon request
- > Wall adjustment and out-of-square compensation up to 2cm
- > Detachable sliding door for easy product cleaning
- > Handle centre-to-centre distance 160mm
- > Digital printing available on all flat glasses TR

# CEE ART

## PRODOTTI DELLA SERIE / PRODUCTS OF THE SERIES

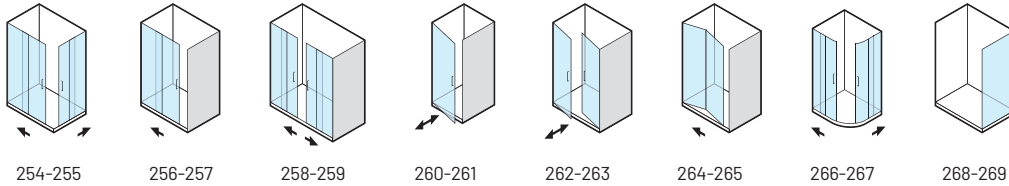

## PROFILI / PROFILES

### STANDARD

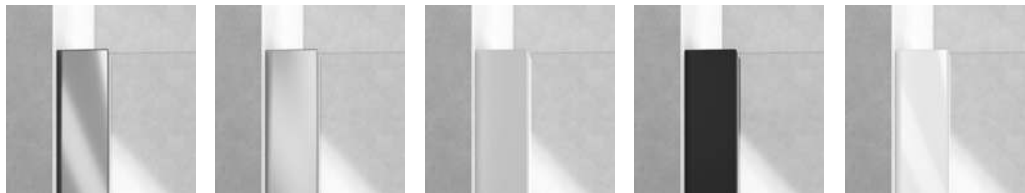

**ULU**  
Brillianto Lucido  
*Brilliant Polished*

**SAR**  
Argento Opaco  
*Silver Glazed Satin*

**L91**  
Bianco Opaco  
*Matte White*

**L96**  
Nero Opaco  
*Matte Black*

**L01**  
Bianco Lucido  
*Glossy White*

### ATELIER

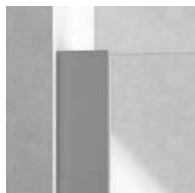

**L95**  
Grigio Opaco  
*Matte Grey*

## VETRO / GLASS

### STANDARD



**TR**  
Trasparente  
*Transparent*

**ST**  
Stampato  
*Printed*

**RF**  
Fascia H.100cm  
*Band H.100cm*

### ON DEMAND



**TE**  
Extrachiaro  
*Extra Clear*

**TG**  
Trasparente Grigio  
*Transparent Grey*

**AS**  
Satinato  
*Satin*

**GS**  
Satinato Grigio  
*Satin Grey*

**SY**  
Specchio  
*Mirror*

# CEE ART

LATO ANGOLO  
SIDE CORNER



Per istruzioni di montaggio  
e ricambi inquadra il codice QR  
For assembly instructions  
and spare parts, scan the QR code



**H. 195cm**  
**SP. 6mm**

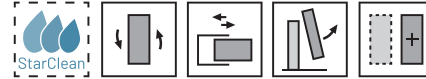

Parete doccia ad angolo a quattro ante, apertura ad ante scorrevoli nell'angolo del prodotto. Modello adatto per la maggior parte delle installazioni e disponibile in un'ampia gamma di dimensioni, soprattutto per chi vuole massimizzare le dimensioni d'ingresso.

Corner shower wall with four panels, featuring sliding doors at the corner of the product. Suitable for most installations and available in a wide range of sizes, especially for those looking to maximize the entry dimensions.

### CONFIGURAZIONE AD ANGOLO CORNER CONFIGURATION

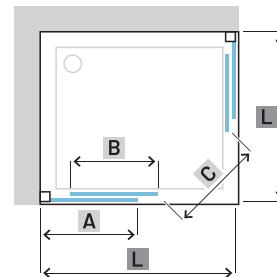

### CONFIGURAZIONE A TRE LATI THREE-SIDED CONFIGURATION

Per le configurazioni a tre lati considerare la parete fissa (L1).  
For three-sided configurations, consider the fixed panel (L1).

### ORIENTAMENTO E POSSIBILI COMBINAZIONI / ORIENTATION AND POSSIBLE CONFIGURATIONS

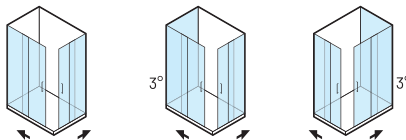

### PROFILI / PROFILES

STANDARD	
ULU	Brillantato Lucido Brilliant Polished
SAR	Satinato Argento Silver Glazed Satin
L91	Bianco Opaco Matte White
L96	Nero Opaco Matte Black
L01	Bianco Lucido Glossy White

In finitura SAR, componentistica e maniglia sono in finitura cromata  
In SAR finish, the components and handle are in a chrome finish

ATELIER	
L95	Grigio Opaco Matte Grey

### VETRO / GLASS

STANDARD	
TR	Trasparente Transparent
ST	Stampato Printed
RF	Fascia H.100cm Band H.100cm

ON DEMAND		
TE	Extrachiaro Extra Clear	TR +25%
TG	Trasparente Grigio Transparent Grey	TR +25%
AS	Satinato Satin	TR +25%
GS	Satinato Grigio Satin Grey	TR +25%
SY	Specchio Mirror <sup>3</sup>	TR +50%

## PORTA / DOOR

L [cm]	COD	A [cm]	B [cm]	C [cm]	[dm <sup>3</sup> ]	[kg]	[Pcs]	V	SAR			L95	
									ULU	L96	L91		L01
67-69	B0916	30,6-32,6	34,3	35	112	26	1	TR	515,00			430,00	515,00
								ST	565,00			475,00	565,00
								RF	645,00			540,00	645,00
70-72	B0914	31,1-33,6	36,8	39	115	28	1	TR	525,00			440,00	525,00
								ST	580,00			485,00	580,00
								RF	655,00			550,00	655,00
72-74	B0917	33,1-35,1	36,8	39	122	28	1	TR	530,00			440,00	530,00
								ST	585,00			485,00	585,00
								RF	665,00			550,00	665,00
75-77	B0915	33,6-35,6	39,3	42	124	30	1	TR	535,00			445,00	535,00
								ST	590,00			490,00	590,00
								RF	670,00			555,00	670,00
77-79	B0918	35,6-37,6	39,3	42	130	30	1	TR	540,00			450,00	540,00
								ST	595,00			495,00	595,00
								RF	675,00			565,00	675,00
80-82	B0919	37,1-39,1	40,8	45	136	30	1	TR	555,00			465,00	555,00
								ST	610,00			510,00	610,00
								RF	695,00			580,00	695,00
87-89	B0920	40,6-42,6	44,3	49	144	35	1	TR	570,00			475,00	570,00
								ST	625,00			525,00	625,00
								RF	715,00			595,00	715,00
90-92	B0922	42,1-44,1	45,8	52	152	35	1	TR	580,00			485,00	580,00
								ST	640,00			535,00	640,00
								RF	725,00			605,00	725,00
97-99	B0921	45,6-47,6	49,3	56	160	38	1	TR	595,00			495,00	595,00
								ST	650,00			545,00	650,00
								RF	745,00			620,00	745,00
117-119	B0923	65,6-67,6	49,3	56	175	41	1	TR	650,00			540,00	650,00
								ST	715,00			595,00	715,00
								RF	815,00			675,00	815,00

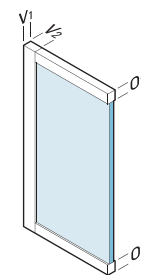

L	
V <sub>1</sub>	28mm
V <sub>2</sub>	36mm
O <sub>1</sub>	45mm
O <sub>2</sub>	45mm

I valori della tabella prezzi si riferiscono ad un singolo lato: sommare l'importo dei due codici della misura desiderata per ottenere il prezzo totale di una doccia ad angolo quadrata o rettangolare.

The prices in the table refer to a single side: add the amounts of the two codes for the desired size to get the total price of a square or rectangular corner shower.

## PARETE FISSA / FIXED PANEL

H. 195cm  
SP. 4mm

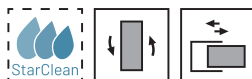

L1 [cm]	COD.	A [cm]	B [cm]	C [cm]	[dm <sup>3</sup> ]	[kg]	[Pcs]	V	SAR			L95	
									ULU	L96	L91		L01
67-69	B0924	-	-	-	116	23	1	TR	365,00			305,00	365,00
								ST	400,00			335,00	400,00
								RF	455,00			380,00	455,00
70-72	B0925	-	-	-	117	23,5	1	TR	370,00			310,00	370,00
								ST	405,00			340,00	405,00
								RF	465,00			390,00	465,00
75-77	B0960	-	-	-	118	24	1	TR	375,00			315,00	375,00
								ST	415,00			345,00	415,00
								RF	470,00			395,00	470,00
77-79	B0926	-	-	-	122	25	1	TR	380,00			315,00	380,00
								ST	420,00			345,00	420,00
								RF	475,00			395,00	475,00
80-82	B0927	-	-	-	124	26	1	TR	390,00			325,00	390,00
								ST	430,00			360,00	430,00
								RF	490,00			405,00	490,00
87-89	B0928	-	-	-	130	27	1	TR	400,00			335,00	400,00
								ST	440,00			370,00	440,00
								RF	500,00			420,00	500,00
90-92	B0961	-	-	-	130	29	1	TR	415,00			345,00	415,00
								ST	455,00			380,00	455,00
								RF	520,00			430,00	520,00
97-99	B0929	-	-	-	136	30	1	TR	425,00			355,00	425,00
								ST	470,00			390,00	470,00
								RF	530,00			445,00	530,00

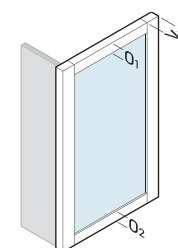

L1	
V <sub>2</sub>	36mm
O <sub>1</sub>	45mm
O <sub>2</sub>	45mm

SU MISURA/CUSTOM	PORTA DOOR	[€]	PARETE FISSA FIXED PANEL	[€]
Altezza/Height <sup>1</sup>	150-210cm	+20%	40-210cm	+20%
Larghezza/Width <sup>2</sup>	50-140cm	+20%	20-140cm	+20%
Altezza/Height Larghezza/Width <sup>2</sup>	150-210cm 50-140cm	+20%	40-210cm 20-140cm	+20%
Altre forme Other shapes <sup>2</sup>		+30%		+30%

OPTIONAL	COD.	[€]
Profilo compensazione Compensation Profile	COM10C (+3cm)	60,00
	L01	90,00
	ULU-L91-L96	90,00
	SAR-L95	90,00
	Porta/Door	50,00
	Parete Fissa/Fixed Panel	50,00

<sup>1</sup> Dal prezzo della misura di riferimento / From the price of selected size

<sup>2</sup> Dal prezzo della misura superiore / From the price of the larger size

<sup>3</sup> Contattare l'ufficio clienti per informazioni / Contact the customer service office for information

DISPONIBILITA' A MAGAZZINO / STOCK AVAILABILITY

1/2 Settimane/Weeks  
+1 StarClean Optional

2/3 Settimane/Weeks

3/4 Settimane/Weeks

# CEE ART

PORTA SCORREVOLE  
SLIDING DOOR



Per istruzioni di montaggio  
e ricambi inquadra il codice QR  
For assembly instructions  
and spare parts, scan the QR code



**H. 195cm**  
**SP. 6mm**

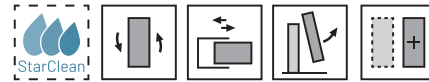

Parete doccia a due ante con apertura laterale scorrevole. Modello adatto per la maggior parte delle installazioni e disponibile in un'ampia gamma di dimensioni.

Shower wall with two panels and side sliding opening. Suitable for most installations and available in a wide range of sizes.

**CONFIGURAZIONE IN NICCHIA**  
**NICHE CONFIGURATION**

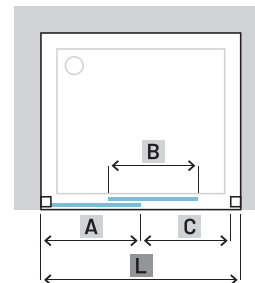

**CONFIGURAZIONE AD ANGOLO**  
**CORNER CONFIGURATION**

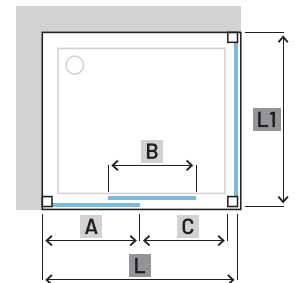

**CONFIGURAZIONE A TRE LATI**  
**THREE-SIDED CONFIGURATION**

Per le configurazioni a tre lati considerare la parete fissa (L1).  
For three-sided configurations, consider the fixed panel (L1).

## ORIENTAMENTO E POSSIBILI COMBINAZIONI / ORIENTATION AND POSSIBLE CONFIGURATIONS

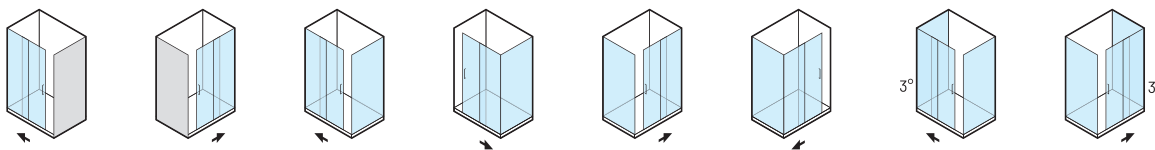

### PROFILI / PROFILES

STANDARD	
ULU	Brillantato Lucido Brilliant Polished
SAR	Satinato Argento Silver Glazed Satin
L91	Bianco Opaco Matte White
L96	Nero Opaco Matte Black
L01	Bianco Lucido Glossy White

In finitura SAR, componentistica e maniglia sono in finitura cromata  
In SAR finish, the components and handle are in a chrome finish

ATELIER	
L95	Grigio Opaco Matte Grey

### VETRO / GLASS

STANDARD	
TR	Trasparente Transparent
ST	Stampato Printed
RF	Fascia H.100cm Band H.100cm

ON DEMAND		
TE	Extrachiaro Extra Clear	TR +25%
TG	Trasparente Grigio Transparent Grey	TR +25%
AS	Satinato Satin	TR +25%
GS	Satinato Grigio Satin Grey	TR +25%
SY	Specchio Mirror <sup>3</sup>	TR +50%

## PORTA / DOOR

L [cm]	COD	A [cm]	B [cm]	C [cm]	[dm <sup>3</sup> ]	[kg]	[Pcs]	V	SAR			L95
									ULU	L96	L91	
97-101	B0980	46,6-48,6	47,8	38	116	35	1	TR	720,00		600,00	720,00
								ST	790,00		660,00	790,00
								RF	900,00		750,00	900,00
107-111	B0981	53,6-55,6	50,8	41	124	37	1	TR	740,00		615,00	740,00
								ST	815,00		675,00	815,00
								RF	925,00		770,00	925,00
117-121	B0983	56,6-58,6	57,8	48	125	38	1	TR	760,00		635,00	760,00
								ST	835,00		700,00	835,00
								RF	950,00		795,00	950,00
127-131	B0985	63,9-65,9	60,8	50	131	39	1	TR	780,00		650,00	780,00
								ST	860,00		715,00	860,00
								RF	975,00		815,00	975,00
137-141	B0986	66,6-68,6	67,8	58	138	40	2	TR	830,00		690,00	830,00
								ST	915,00		760,00	915,00
								RF	1.040,00		865,00	1.040,00
147-151	B0987	71,6-73,6	72,8	63	143	41	2	TR	850,00		710,00	850,00
								ST	935,00		780,00	935,00
								RF	1.065,00		890,00	1.065,00
157-161	B0989	76,6-78,6	77,8	68	149	42	2	TR	870,00		725,00	870,00
								ST	955,00		800,00	955,00
								RF	1.090,00		905,00	1.090,00
167-171	B0990	81,6-83,6	82,8	73	149	44	2	TR	900,00		750,00	900,00
								ST	990,00		825,00	990,00
								RF	1.125,00		940,00	1.125,00

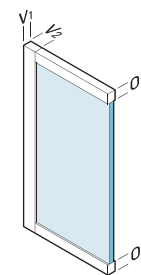

L	V1	V2	O1	O2
	45mm	36mm	45mm	45mm

## PARETE FISSA / FIXED PANEL

H. 195cm  
SP. 4mm

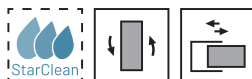

L1 [cm]	COD.	A [cm]	B [cm]	C [cm]	[dm <sup>3</sup> ]	[kg]	[Pcs]	V	SAR			L95
									ULU	L96	L91	
67-69	B0924	-	-	-	116	23	1	TR	365,00		305,00	365,00
								ST	400,00		335,00	400,00
								RF	455,00		380,00	455,00
70-72	B0925	-	-	-	117	23,5	1	TR	370,00		310,00	370,00
								ST	405,00		340,00	405,00
								RF	465,00		390,00	465,00
75-77	B0960	-	-	-	118	24	1	TR	375,00		315,00	375,00
								ST	415,00		345,00	415,00
								RF	470,00		395,00	470,00
77-79	B0926	-	-	-	122	25	1	TR	380,00		315,00	380,00
								ST	420,00		345,00	420,00
								RF	475,00		395,00	475,00
80-82	B0927	-	-	-	124	26	1	TR	390,00		325,00	390,00
								ST	430,00		360,00	430,00
								RF	490,00		405,00	490,00
87-89	B0928	-	-	-	130	27	1	TR	400,00		335,00	400,00
								ST	440,00		370,00	440,00
								RF	500,00		420,00	500,00
90-92	B0961	-	-	-	130	29	1	TR	415,00		345,00	415,00
								ST	455,00		380,00	455,00
								RF	520,00		430,00	520,00
97-99	B0929	-	-	-	136	30	1	TR	425,00		355,00	425,00
								ST	470,00		390,00	470,00
								RF	530,00		445,00	530,00

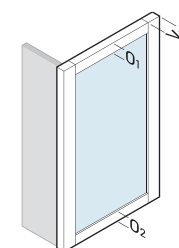

L1	V2	O1	O2
	36mm	45mm	45mm

SU MISURA/CUSTOM	PORTA DOOR	[€]	PARETE FISSA FIXED PANEL	[€]
Altezza/Height <sup>1</sup>	130-210cm	+20%	40-210cm	+20%
Larghezza/Width <sup>2</sup>	80-185cm	+20%	20-140cm	+20%
Altezza/Height Larghezza/Width <sup>2</sup>	130-210cm 80-185cm	+20%	40-210cm 20-140cm	+20%
Altre forme Other shapes <sup>2</sup>		+30%		+30%

OPTIONAL	COD.	[€]
Profilo compensazione Compensation Profile	L01	60,00
	COM10C (+3cm)	90,00
	SAR-L95	90,00
StarClean	Porta/Door	50,00
	Parete Fissa/Fixed Panel	50,00

<sup>1</sup> Dal prezzo della misura di riferimento / From the price of selected size

<sup>2</sup> Dal prezzo della misura superiore / From the price of the larger size

<sup>3</sup> Contattare l'ufficio clienti per informazioni / Contact the customer service office for information

DISPONIBILITA' A MAGAZZINO / STOCK AVAILABILITY

1/2 Settimane/Weeks

2/3 Settimane/Weeks

3/4 Settimane/Weeks

# CEE ART

DOPPIA PORTA SCORREVOLE  
DOUBLE SLIDING DOOR



Per istruzioni di montaggio  
e ricambi inquadra il codice QR  
For assembly instructions  
and spare parts, scan the QR code



H. 195cm  
SP. 6mm

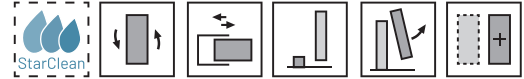

Parete doccia a quattro ante con apertura centrale. L'apertura è centrale data dalle due ante centrali scorrevoli in modo contrapposto. Modello adatto per installazioni di generose dimensioni.

Shower enclosure with four panels and a central opening. The opening is created by the two central sliding doors, which move in opposite directions. This model is suitable for large-scale installations.

CONFIGURAZIONE IN NICCHIA  
NICHE CONFIGURATION

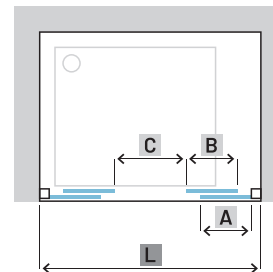

CONFIGURAZIONE AD ANGOLO  
CORNER CONFIGURATION

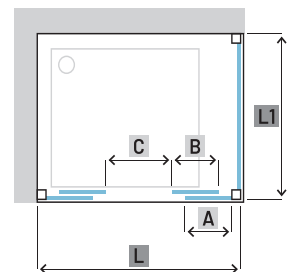

CONFIGURAZIONE A TRE LATI  
THREE-SIDED CONFIGURATION

Per le configurazioni a tre lati considerare la parete fissa (L1).  
For three-sided configurations, consider the fixed panel (L1).

## ORIENTAMENTO E POSSIBILI COMBINAZIONI / ORIENTATION AND POSSIBLE CONFIGURATIONS

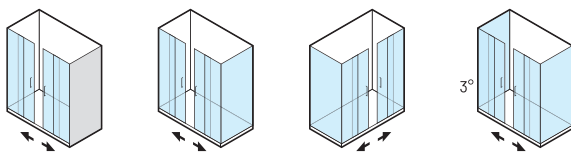

### PROFILI / PROFILES

STANDARD	
ULU	Brillantato Lucido Brilliant Polished
SAR	Satinato Argento Silver Glazed Satin
L91	Bianco Opaco Matte White
L96	Nero Opaco Matte Black
L01	Bianco Lucido Glossy White

In finitura SAR, componentistica e maniglia sono in finitura cromata  
In SAR finish, the components and handle are in a chrome finish

ATELIER	
L95	Grigio Opaco Matte Grey

### VETRO / GLASS

STANDARD	
TR	Trasparente Transparent
ST	Stampato Printed
RF	Fascia H.100cm Band H.100cm

ON DEMAND		
TE	Extrachiaro Extra Clear	TR +25%
TG	Trasparente Grigio Transparent Grey	TR +25%
AS	Satinato Satin	TR +25%
GS	Satinato Grigio Satin Grey	TR +25%
SY	Specchio Mirror <sup>3</sup>	TR +50%

**PORTA / DOOR**

L [cm]	COD	A [cm]	B [cm]	C [cm]	[dm <sup>3</sup> ]	[kg]	[Pcs]	V	SAR			L95
									ULU	L96	L91	
137-141	B0944	34,1-36,1	36,8	54	161	51	2	TR	980,00		815,00	980,00
								ST	1.080,00		895,00	1.080,00
								RF	1.225,00		1.020,00	1.225,00
142-146	B0945	37,1	36,8	54	165	52	2	TR	995,00		830,00	995,00
								ST	1.095,00		915,00	1.095,00
								RF	1.245,00		1.040,00	1.245,00
157-161	B0946	39,1-41,1	41,8	64	170	54	2	TR	1.030,00		860,00	1.030,00
								ST	1.135,00		945,00	1.135,00
								RF	1.290,00		1.075,00	1.290,00
162-166	B0940	41,6	41,8	64	172	55	2	TR	1.035,00		865,00	1.035,00
								ST	1.140,00		950,00	1.140,00
								RF	1.295,00		1.080,00	1.295,00
167-171	B0947	41,6-43,6	44,3	69	173	56	2	TR	1.045,00		870,00	1.045,00
								ST	1.150,00		955,00	1.150,00
								RF	1.305,00		1.090,00	1.305,00
172-176	B0941	45,1	44,3	69	178	57	2	TR	1.055,00		880,00	1.055,00
								ST	1.160,00		970,00	1.160,00
								RF	1.320,00		1.100,00	1.320,00
177-181	B0948	43,1-45,1	47,8	72	183	58	2	TR	1.065,00		890,00	1.065,00
								ST	1.170,00		980,00	1.170,00
								RF	1.330,00		1.115,00	1.330,00

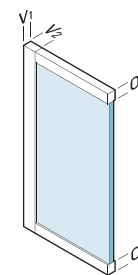

L	Value
V <sub>1</sub>	45mm
V <sub>2</sub>	36mm
O <sub>1</sub>	45mm
O <sub>2</sub>	45mm

**PARETE FISSA / FIXED PANEL**

H. 195cm  
SP. 4mm

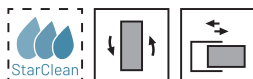

L1 [cm]	COD.	A [cm]	B [cm]	C [cm]	[dm <sup>3</sup> ]	[kg]	[Pcs]	V	SAR			L95
									ULU	L96	L91	
67-69	B0924	-	-	-	116	23	1	TR	365,00		305,00	365,00
								ST	400,00		335,00	400,00
								RF	455,00		380,00	455,00
70-72	B0925	-	-	-	117	23,5	1	TR	370,00		310,00	370,00
								ST	405,00		340,00	405,00
								RF	465,00		390,00	465,00
75-77	B0960	-	-	-	118	24	1	TR	375,00		315,00	375,00
								ST	415,00		345,00	415,00
								RF	470,00		395,00	470,00
77-79	B0926	-	-	-	122	25	1	TR	380,00		315,00	380,00
								ST	420,00		345,00	420,00
								RF	475,00		395,00	475,00
80-82	B0927	-	-	-	124	26	1	TR	390,00		325,00	390,00
								ST	430,00		360,00	430,00
								RF	490,00		405,00	490,00
87-89	B0928	-	-	-	130	27	1	TR	400,00		335,00	400,00
								ST	440,00		370,00	440,00
								RF	500,00		420,00	500,00
90-92	B0961	-	-	-	130	29	1	TR	415,00		345,00	415,00
								ST	455,00		380,00	455,00
								RF	520,00		430,00	520,00
97-99	B0929	-	-	-	136	30	1	TR	425,00		355,00	425,00
								ST	470,00		390,00	470,00
								RF	530,00		445,00	530,00

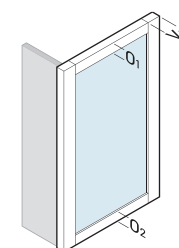

L1	Value
V <sub>2</sub>	36mm
O <sub>1</sub>	45mm
O <sub>2</sub>	45mm

SU MISURA/CUSTOM	PORTA DOOR	[€]	PARETE FISSA FIXED PANEL	[€]
Altezza/Height <sup>1</sup>	150-210cm	+20%	40-210cm	+20%
Larghezza/Width <sup>2</sup>	100-200cm	+20%	20-140cm	+20%
Altezza/Height Larghezza/Width <sup>2</sup>	150-210cm 100-200cm	+20%	40-210cm 20-140cm	+20%
Altre forme Other shapes <sup>2</sup>		+30%		+30%

OPTIONAL	COD.	[€]
Profilo compensazione Compensation Profile	L01	60,00
	COM10C (+3cm)	90,00
	SAR-L95	90,00
StarClean	Porta/Door	100,00
	Parete Fissa/Fixed Panel	50,00

<sup>1</sup> Dal prezzo della misura di riferimento / From the price of selected size  
<sup>2</sup> Dal prezzo della misura superiore / From the price of the larger size  
<sup>3</sup> Contattare l'ufficio clienti per informazioni / Contact the customer service office for information

DISPONIBILITA' A MAGAZZINO / STOCK AVAILABILITY  
**1/2** Settimane/Weeks **2/3** Settimane/Weeks **3/4** Settimane/Weeks  
 +1 StarClean Optional

# CEE ART

PORTA BATTENTE  
HINGED DOOR



Per istruzioni di montaggio  
e ricambi inquadra il codice QR  
For assembly instructions  
and spare parts, scan the QR code



**H. 195cm**  
**SP. 6mm**

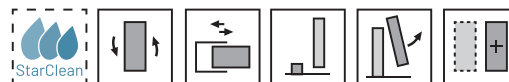

Parete doccia con apertura a porta battente. L'apertura dell'anta è sia verso l'interno che verso l'esterno. Modello adatto per situazioni che necessitano della massima apertura possibile.

Shower enclosure with a hinged door. The door opens both inward and outward. A model suitable for situations requiring the maximum possible opening.

**CONFIGURAZIONE IN NICCHIA**  
**NICHE CONFIGURATION**

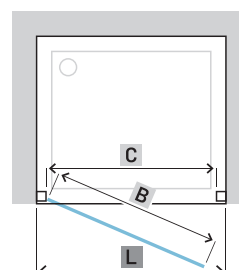

**CONFIGURAZIONE AD ANGOLO**  
**CORNER CONFIGURATION**

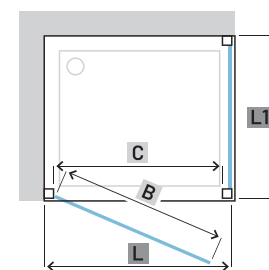

**CONFIGURAZIONE A TRE LATI**  
**THREE-SIDED CONFIGURATION**

Per le configurazioni a tre lati considerare la parete fissa (L1).  
For three-sided configurations, consider the fixed panel (L1).

## ORIENTAMENTO E POSSIBILI COMBINAZIONI / ORIENTATION AND POSSIBLE CONFIGURATIONS

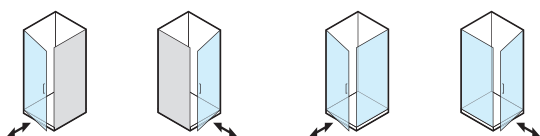

### PROFILI / PROFILES

STANDARD	
ULU	Brillantato Lucido Brilliant Polished
SAR	Satinato Argento Silver Glazed Satin
L91	Bianco Opaco Matte White
L96	Nero Opaco Matte Black
L01	Bianco Lucido Glossy White

In finitura SAR, componentistica e maniglia sono in finitura cromata  
In SAR finish, the components and handle are in a chrome finish

ATELIER	
L95	Grigio Opaco Matte Grey

### VETRO / GLASS

STANDARD	
TR	Trasparente Transparent
ST	Stampato Printed
RF	Fascia H.100cm Band H.100cm

ON DEMAND		
TE	Extrachiaro Extra Clear	TR +25%
TG	Trasparente Grigio Transparent Grey	TR +25%
AS	Satinato Satin	TR +25%
GS	Satinato Grigio Satin Grey	TR +25%
SY	Specchio Mirror <sup>3</sup>	TR +50%

**PORTA / DOOR**

L [cm]	COD	A [cm]	B [cm]	C [cm]	[dm <sup>3</sup> ]	[kg]	[Pcs]	V	SAR			L95	
									ULU	L96	L91		L01
62-66	B0900	-	47,9	50	112	23	1	TR	585,00			490,00	585,00
								ST	645,00			540,00	645,00
								RF	730,00			615,00	730,00
67-71	B0901	-	52,9	55	115	24	1	TR	595,00			495,00	595,00
								ST	655,00			545,00	655,00
								RF	745,00			620,00	745,00
72-76	B0905	-	57,9	60	125	26	1	TR	605,00			505,00	605,00
								ST	665,00			555,00	665,00
								RF	755,00			630,00	755,00
77-81	B0902	-	62,9	65	131	27	1	TR	615,00			515,00	615,00
								ST	675,00			565,00	675,00
								RF	770,00			645,00	770,00
82-86	B0906	-	67,9	70	141	28	1	TR	625,00			520,00	625,00
								ST	690,00			570,00	690,00
								RF	780,00			650,00	780,00
87-91	B0903	-	72,9	75	151	29	1	TR	635,00			530,00	635,00
								ST	700,00			585,00	700,00
								RF	795,00			665,00	795,00
97-101	B0904	-	82,9	85	156	31	1	TR	655,00			545,00	655,00
								ST	720,00			600,00	720,00
								RF	820,00			680,00	820,00

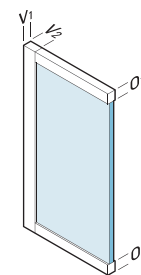

L	
V <sub>1</sub>	45mm
V <sub>2</sub>	36mm
O <sub>1</sub>	45mm
O <sub>2</sub>	45mm

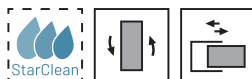
**PARETE FISSA / FIXED PANEL**
**H. 195cm**  
**SP. 4mm**

L1 [cm]	COD.	A [cm]	B [cm]	C [cm]	[dm <sup>3</sup> ]	[kg]	[Pcs]	V	SAR			L95	
									ULU	L96	L91		L01
67-69	B0924	-	-	-	116	23	1	TR	365,00			305,00	365,00
								ST	400,00			335,00	400,00
								RF	455,00			380,00	455,00
70-72	B0925	-	-	-	117	23,5	1	TR	370,00			310,00	370,00
								ST	405,00			340,00	405,00
								RF	465,00			390,00	465,00
75-77	B0960	-	-	-	118	24	1	TR	375,00			315,00	375,00
								ST	415,00			345,00	415,00
								RF	470,00			395,00	470,00
77-79	B0926	-	-	-	122	25	1	TR	380,00			315,00	380,00
								ST	420,00			345,00	420,00
								RF	475,00			395,00	475,00
80-82	B0927	-	-	-	124	26	1	TR	390,00			325,00	390,00
								ST	430,00			360,00	430,00
								RF	490,00			405,00	490,00
87-89	B0928	-	-	-	130	27	1	TR	400,00			335,00	400,00
								ST	440,00			370,00	440,00
								RF	500,00			420,00	500,00
90-92	B0961	-	-	-	130	29	1	TR	415,00			345,00	415,00
								ST	455,00			380,00	455,00
								RF	520,00			430,00	520,00
97-99	B0929	-	-	-	136	30	1	TR	425,00			355,00	425,00
								ST	470,00			390,00	470,00
								RF	530,00			445,00	530,00

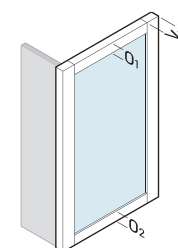

L1	
V <sub>2</sub>	36mm
O <sub>1</sub>	45mm
O <sub>2</sub>	45mm

SU MISURA/CUSTOM	PORTA DOOR	[€]	PARETE FISSA FIXED PANEL	[€]
Altezza/Height <sup>1</sup>	150-210cm	+20%	40-210cm	+20%
Larghezza/Width <sup>2</sup>	50-100cm	+20%	20-140cm	+20%
Altezza/Height Larghezza/Width <sup>2</sup>	150-210cm 50-100cm	+20%	40-210cm 20-140cm	+20%
Altre forme Other shapes <sup>2</sup>		+30%		+30%

OPTIONAL	COD.	[€]
Profilo compensazione Compensation Profile	L01	60,00
	COM10C (+3cm)	90,00
	SAR-L95	90,00
StarClean	Porta/Door	50,00
	Parete Fissa/Fixed Panel	50,00

<sup>1</sup> Dal prezzo della misura di riferimento / From the price of selected size

<sup>2</sup> Dal prezzo della misura superiore / From the price of the larger size

<sup>3</sup> Contattare l'ufficio clienti per informazioni / Contact the customer service office for information

**DISPONIBILITA' A MAGAZZINO / STOCK AVAILABILITY**
**1/2** Settimane/Weeks

**2/3** Settimane/Weeks

**3/4** Settimane/Weeks

**+1** StarClean Optional

# CEE ART

PORTA SALOON  
SALOON DOOR



Per istruzioni di montaggio  
e ricambi inquadra il codice QR  
For assembly instructions  
and spare parts, scan the QR code



**H. 195cm**  
**SP. 6mm**

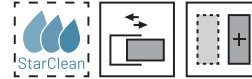

Parete doccia con due ante con apertura a saloon. L'apertura delle ante è sia verso l'interno che verso l'esterno. Modello adatto per situazioni che necessitano di un ingresso ampio, ma con spazio di installazione limitato.

Shower enclosure with two saloon-style doors. The doors open both inward and outward. A model suitable for situations requiring a wide entry but with limited installation space.

**CONFIGURAZIONE IN NICCHIA**  
**NICHE CONFIGURATION**

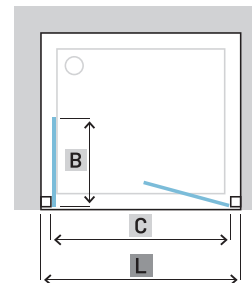

**CONFIGURAZIONE AD ANGOLO**  
**CORNER CONFIGURATION**

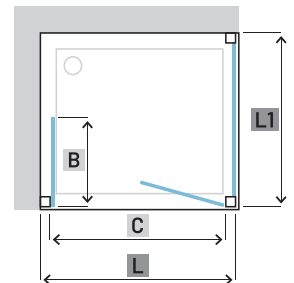

**CONFIGURAZIONE A TRE LATI**  
**THREE-SIDED CONFIGURATION**

Per le configurazioni a tre lati considerare la parete fissa (L1).  
For three-sided configurations, consider the fixed panel (L1).

## ORIENTAMENTO E POSSIBILI COMBINAZIONI / ORIENTATION AND POSSIBLE CONFIGURATIONS

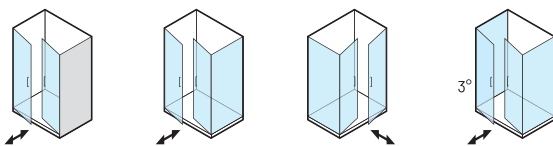

### PROFILI / PROFILES

STANDARD	
ULU	Brillantato Lucido Brilliant Polished
SAR	Satinato Argento Silver Glazed Satin
L91	Bianco Opaco Matte White
L96	Nero Opaco Matte Black
L01	Bianco Lucido Glossy White

In finitura SAR, componentistica e maniglia sono in finitura cromata  
In SAR finish, the components and handle are in a chrome finish

ATELIER	
L95	Grigio Opaco Matte Grey

### VETRO / GLASS

STANDARD	
TR	Trasparente Transparent
ST	Stampato Printed
RF	Fascia H.100cm Band H.100cm

ON DEMAND		
TE	Extrachiaro Extra Clear	TR +25%
TG	Trasparente Grigio Transparent Grey	TR +25%
AS	Satinato Satin	TR +25%
GS	Satinato Grigio Satin Grey	TR +25%
SY	Specchio Mirror <sup>3</sup>	TR +50%

**PORTA / DOOR**

L [cm]	COD	A [cm]	B [cm]	C [cm]	[dm <sup>3</sup> ]	[kg]	[Pcs]	V	SAR			L95
									ULU	L96	L91	
67-71	B0930	-	24,2	52	114	24	1	TR	620,00		515,00	620,00
								ST	680,00		565,00	680,00
								RF	775,00		645,00	775,00
72-76	B0931	-	26,7	57	122	25	1	TR	630,00		525,00	630,00
								ST	695,00		580,00	695,00
								RF	790,00		655,00	790,00
77-81	B0932	-	29,2	62	139	28	1	TR	640,00		535,00	640,00
								ST	705,00		590,00	705,00
								RF	800,00		670,00	800,00
82-86	B0937	-	31,7	67	149	30	1	TR	650,00		540,00	650,00
								ST	715,00		595,00	715,00
								RF	815,00		675,00	815,00
87-91	B0933	-	34,2	72	152	31	1	TR	660,00		550,00	660,00
								ST	725,00		605,00	725,00
								RF	825,00		690,00	825,00
92-96	B0938	-	36,7	77	162	32	1	TR	675,00		565,00	675,00
								ST	745,00		620,00	745,00
								RF	845,00		705,00	845,00
97-101	B0934	-	39,2	82	178	35	1	TR	680,00		565,00	680,00
								ST	750,00		620,00	750,00
								RF	850,00		705,00	850,00
107-111	B0935	-	44,2	92	162	33	1	TR	700,00		585,00	700,00
								ST	770,00		645,00	770,00
								RF	875,00		730,00	875,00
117-121	B0936	-	49,2	102	163	34	1	TR	720,00		600,00	720,00
								ST	790,00		660,00	790,00
								RF	900,00		750,00	900,00

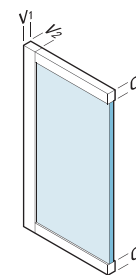

L	V1	V2	O1	O2
	45mm	36mm	45mm	45mm

**PARETE FISSA / FIXED PANEL**

H. 195cm  
SP. 4mm

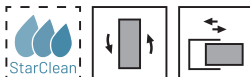

L1 [cm]	COD.	A [cm]	B [cm]	C [cm]	[dm <sup>3</sup> ]	[kg]	[Pcs]	V	SAR			L95
									ULU	L96	L91	
67-69	B0924	-	-	-	116	23	1	TR	365,00		305,00	365,00
								ST	400,00		335,00	400,00
								RF	455,00		380,00	455,00
70-72	B0925	-	-	-	117	23,5	1	TR	370,00		310,00	370,00
								ST	405,00		340,00	405,00
								RF	465,00		390,00	465,00
75-77	B0960	-	-	-	118	24	1	TR	375,00		315,00	375,00
								ST	415,00		345,00	415,00
								RF	470,00		395,00	470,00
77-79	B0926	-	-	-	122	25	1	TR	380,00		315,00	380,00
								ST	420,00		345,00	420,00
								RF	475,00		395,00	475,00
80-82	B0927	-	-	-	124	26	1	TR	390,00		325,00	390,00
								ST	430,00		360,00	430,00
								RF	490,00		405,00	490,00
87-89	B0928	-	-	-	130	27	1	TR	400,00		335,00	400,00
								ST	440,00		370,00	440,00
								RF	500,00		420,00	500,00
90-92	B0961	-	-	-	130	29	1	TR	415,00		345,00	415,00
								ST	455,00		380,00	455,00
								RF	520,00		430,00	520,00
97-99	B0929	-	-	-	136	30	1	TR	425,00		355,00	425,00
								ST	470,00		390,00	470,00
								RF	530,00		445,00	530,00

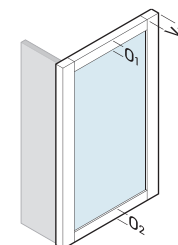

L1	V2	O1	O2
	36mm	45mm	45mm

SU MISURA/CUSTOM	PORTA DOOR	[€]	PARETE FISSA FIXED PANEL	[€]
Altezza/Height <sup>1</sup>	130-210cm	+20%	40-210cm	+20%
Larghezza/Width <sup>2</sup>	50-125cm	+20%	20-140cm	+20%
Altezza/Height Larghezza/Width <sup>2</sup>	130-210cm 50-125cm	+20%	40-210cm 20-140cm	+20%
Altre forme Other shapes <sup>2</sup>		+30%		+30%

OPTIONAL	COD.	[€]
Profilo compensazione Compensation Profile	L01	60,00
	COM10C (+3cm)	90,00
	SAR-L95	90,00
StarClean	Porta/Door	50,00
	Parete Fissa/Fixed Panel	50,00

<sup>1</sup> Dal prezzo della misura di riferimento / From the price of selected size

<sup>2</sup> Dal prezzo della misura superiore / From the price of the larger size

<sup>3</sup> Contattare l'ufficio clienti per informazioni / Contact the customer service office for information

DISPONIBILITÀ A MAGAZZINO / STOCK AVAILABILITY

1/2 Settimane/Weeks

2/3 Settimane/Weeks

3/4 Settimane/Weeks

+1 StarClean Optional

# CEE ART

PORTA SOFFIETTO  
FOLDING DOOR



Per istruzioni di montaggio  
e ricambi inquadra il codice QR  
For assembly instructions  
and spare parts, scan the QR code



**H. 195cm**  
**SP. 6mm**

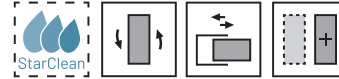

Parete doccia con due ante con apertura a soffietto. L'apertura delle ante è verso l'interno. Modello adatto per situazioni che necessitano di un ingresso ampio, ma con spazio di installazione limitato.

Shower enclosure with two folding doors. The doors open inward. This model is suitable for situations requiring a wide entrance, but with limited installation space.

**CONFIGURAZIONE IN NICCHIA**  
**NICHE CONFIGURATION**

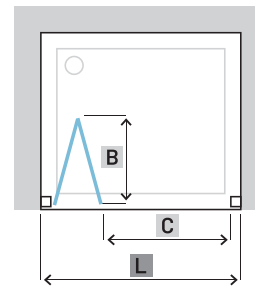

**CONFIGURAZIONE AD ANGOLO**  
**CORNER CONFIGURATION**

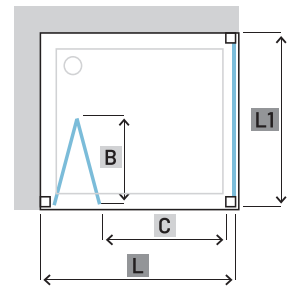

**CONFIGURAZIONE A TRE LATI**  
**THREE-SIDED CONFIGURATION**

Per le configurazioni a tre lati considerare la parete fissa (L1).  
For three-sided configurations, consider the fixed panel (L1).

## ORIENTAMENTO E POSSIBILI COMBINAZIONI / ORIENTATION AND POSSIBLE CONFIGURATIONS

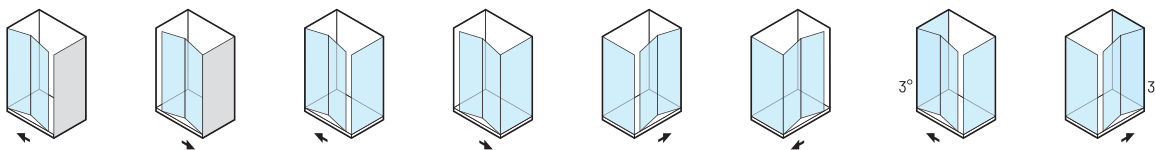

### PROFILI / PROFILES

STANDARD	
ULU	Brillantato Lucido Brilliant Polished
SAR	Satinato Argento Silver Glazed Satin
L91	Bianco Opaco Matte White
L96	Nero Opaco Matte Black
L01	Bianco Lucido Glossy White

In finitura SAR, componentistica e maniglia sono in finitura cromata  
In SAR finish, the components and handle are in a chrome finish

ATELIER	
L95	Grigio Opaco Matte Grey

### VETRO / GLASS

STANDARD	
TR	Trasparente Transparent
ST	Stampato Printed
RF	Fascia H.100cm Band H.100cm

ON DEMAND		
TE	Extrachiaro Extra Clear	TR +25%
TG	Trasparente Grigio Transparent Grey	TR +25%
AS	Satinato Satin	TR +25%
GS	Satinato Grigio Satin Grey	TR +25%
SY	Specchio Mirror <sup>3</sup>	TR +50%

## PORTA / DOOR

L [cm]	COD	A [cm]	B [cm]	C [cm]	[dm <sup>3</sup> ]	[kg]	[Pcs]	V	SAR			L95
									ULU	L96	L91	
67-71	B0907	-	32,5	41	120	25	1	TR	820,00	685,00	820,00	
								ST	900,00	755,00	900,00	
								RF	1.025,00	855,00	1.025,00	
72-76	B0908	-	35	46	124	27	1	TR	830,00	690,00	830,00	
								ST	915,00	760,00	915,00	
								RF	1.040,00	865,00	1.040,00	
77-81	B0909	-	37,7	50	133	28	1	TR	840,00	700,00	840,00	
								ST	925,00	770,00	925,00	
								RF	1.050,00	875,00	1.050,00	
82-86	B0912	-	40	56	142	30	1	TR	855,00	715,00	855,00	
								ST	940,00	785,00	940,00	
								RF	1.070,00	895,00	1.070,00	
87-91	B0910	-	42,8	59	157	31	1	TR	865,00	720,00	865,00	
								ST	950,00	790,00	950,00	
								RF	1.080,00	900,00	1.080,00	
92-96	B0913	-	45	66	156	33	1	TR	875,00	730,00	875,00	
								ST	965,00	805,00	965,00	
								RF	1.095,00	915,00	1.095,00	
97-101	B0911	-	47,8	68	162	34	1	TR	885,00	740,00	885,00	
								ST	975,00	815,00	975,00	
								RF	1.105,00	925,00	1.105,00	

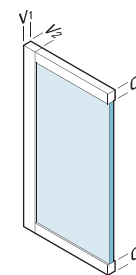

L	V1	V2	O1	O2
	45mm	36mm	45mm	45mm

## PARETE FISSA / FIXED PANEL

H. 195cm  
SP. 4mm

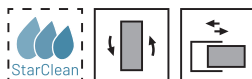

L1 [cm]	COD.	A [cm]	B [cm]	C [cm]	[dm <sup>3</sup> ]	[kg]	[Pcs]	V	SAR			L95
									ULU	L96	L91	
67-69	B0924	-	-	-	116	23	1	TR	365,00	305,00	365,00	
								ST	400,00	335,00	400,00	
								RF	455,00	380,00	455,00	
70-72	B0925	-	-	-	117	23,5	1	TR	370,00	310,00	370,00	
								ST	405,00	340,00	405,00	
								RF	465,00	390,00	465,00	
75-77	B0960	-	-	-	118	24	1	TR	375,00	315,00	375,00	
								ST	415,00	345,00	415,00	
								RF	470,00	395,00	470,00	
77-79	B0926	-	-	-	122	25	1	TR	380,00	315,00	380,00	
								ST	420,00	345,00	420,00	
								RF	475,00	395,00	475,00	
80-82	B0927	-	-	-	124	26	1	TR	390,00	325,00	390,00	
								ST	430,00	360,00	430,00	
								RF	490,00	405,00	490,00	
87-89	B0928	-	-	-	130	27	1	TR	400,00	335,00	400,00	
								ST	440,00	370,00	440,00	
								RF	500,00	420,00	500,00	
90-92	B0961	-	-	-	130	29	1	TR	415,00	345,00	415,00	
								ST	455,00	380,00	455,00	
								RF	520,00	430,00	520,00	
97-99	B0929	-	-	-	136	30	1	TR	425,00	355,00	425,00	
								ST	470,00	390,00	470,00	
								RF	530,00	445,00	530,00	

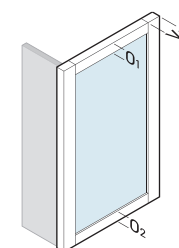

L1	V2	O1	O2
	36mm	45mm	45mm

SU MISURA/CUSTOM	PORTA DOOR	[€]	PARETE FISSA FIXED PANEL	[€]
Altezza/Height <sup>1</sup>	150-210cm	+20%	40-210cm	+20%
Larghezza/Width <sup>2</sup>	50-120cm	+20%	20-140cm	+20%
Altezza/Height Larghezza/Width <sup>2</sup>	150-210cm 50-120cm	+20%	40-210cm 20-140cm	+20%
Altre forme Other shapes <sup>2</sup>		+30%		+30%

OPTIONAL	COD.	[€]
Profilo compensazione Compensation Profile	L01	60,00
	COM10C (+3cm)	90,00
	SAR-L95	90,00
StarClean	Porta/Door	50,00
	Parete Fissa/Fixed Panel	50,00

<sup>1</sup> Dal prezzo della misura di riferimento / From the price of selected size

<sup>2</sup> Dal prezzo della misura superiore / From the price of the larger size

<sup>3</sup> Contattare l'ufficio clienti per informazioni / Contact the customer service office for information

DISPONIBILITA' A MAGAZZINO / STOCK AVAILABILITY

1/2 Settimane/Weeks

2/3 Settimane/Weeks

3/4 Settimane/Weeks

+1 StarClean Optional

# CEE ART

STONDATO DOPPIA PORTA SCORREVOLE  
ROUNDED DOUBLE SLIDING DOOR



Per istruzioni di montaggio  
e ricambi inquadra il codice QR  
For assembly instructions  
and spare parts, scan the QR code



**H. 195cm**  
**SP. 6mm**

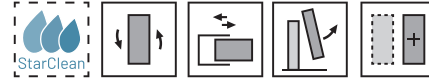

Parete doccia stondata disponibile in versioni per installazioni in angolo in dimensioni quadrate. Il modello dispone di due ante di cui una scorrevole apribile lateralmente.

Curved shower enclosure available in versions for corner installations, in square dimensions. The model features two panels, one of which is a sliding door that opens sideways.

### CONFIGURAZIONE AD ANGOLO CORNER CONFIGURATION

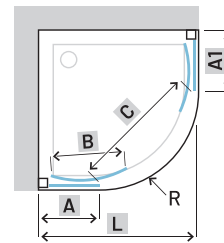

**B0953** R 55cm  
**B0952** R 55cm  
**B0954** R 55cm

### CONFIGURAZIONE A TRE LATI THREE-SIDED CONFIGURATION

Per le configurazioni a tre lati considerare la parete fissa (L1).  
For three-sided configurations, consider the fixed panel (L1).

### ORIENTAMENTO E POSSIBILI COMBINAZIONI / ORIENTATION AND POSSIBLE CONFIGURATIONS

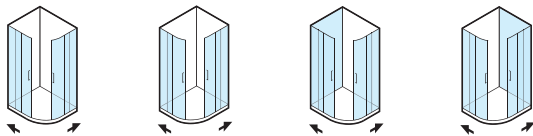

### PROFILI / PROFILES

STANDARD	
<b>ULU</b>	Brillantato Lucido Brilliant Polished
<b>SAR</b>	Satinato Argento Silver Glazed Satin
<b>L91</b>	Bianco Opaco Matte White
<b>L96</b>	Nero Opaco Matte Black
<b>L01</b>	Bianco Lucido Glossy White

In finitura SAR, componentistica e maniglia sono in finitura cromata  
In SAR finish, the components and handle are in a chrome finish

ATELIER	
<b>L95</b>	Grigio Opaco Matte Grey

### VETRO / GLASS

STANDARD	
<b>TR</b>	Trasparente Transparent
<b>ST</b>	Stampato Printed
<b>RF</b>	Fascia H.100cm Band H.100cm

ON DEMAND		
<b>TE</b>	Extrachiaro Extra Clear	TR +25%
<b>TG</b>	Trasparente Grigio Transparent Grey	TR +25%
<b>AS</b>	Satinato Satin	TR +25%
<b>GS</b>	Satinato Grigio Satin Grey	TR +25%
<b>SY</b>	Specchio Mirror <sup>3</sup>	TR +50%

## PORTA / DOOR

L [cm]	COD	A [cm]	B [cm]	C [cm]	[dm <sup>3</sup> ]	[kg]	[Pcs]	V	SAR			L95
									ULU	L96	L91	
77-79	B0953	23,1-25,1	40	38	238	48	2	TR	1.115,00		930,00	1.115,00
								ST	1.225,00		1.025,00	1.225,00
								RF	1.395,00		1.165,00	1.395,00
87-89	B0952	33,1-35,1	40	51	273	54	2	TR	1.175,00		980,00	1.175,00
								ST	1.295,00		1.080,00	1.295,00
								RF	1.470,00		1.225,00	1.470,00
97-99	B0954	43,1-45,1	40	51	330	61	2	TR	1.270,00		1.060,00	1.270,00
								ST	1.395,00		1.165,00	1.395,00
								RF	1.590,00		1.325,00	1.590,00

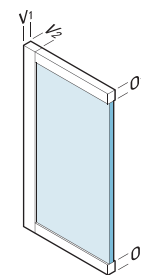

L	
V <sub>1</sub>	45mm
V <sub>2</sub>	36mm
O <sub>1</sub>	45mm
O <sub>2</sub>	45mm

## PARETE FISSA / FIXED PANEL

H. 195cm  
SP. 4mm

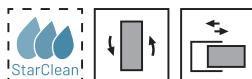

L1 [cm]	COD.	A [cm]	B [cm]	C [cm]	[dm <sup>3</sup> ]	[kg]	[Pcs]	V	SAR			L95
									ULU	L96	L91	
67-69	B0924	-	-	-	116	23	1	TR	365,00		305,00	365,00
								ST	400,00		335,00	400,00
								RF	455,00		380,00	455,00
70-72	B0925	-	-	-	117	23,5	1	TR	370,00		310,00	370,00
								ST	405,00		340,00	405,00
								RF	465,00		390,00	465,00
75-77	B0960	-	-	-	118	24	1	TR	375,00		315,00	375,00
								ST	415,00		345,00	415,00
								RF	470,00		395,00	470,00
77-79	B0926	-	-	-	122	25	1	TR	380,00		315,00	380,00
								ST	420,00		345,00	420,00
								RF	475,00		395,00	475,00
80-82	B0927	-	-	-	124	26	1	TR	390,00		325,00	390,00
								ST	430,00		360,00	430,00
								RF	490,00		405,00	490,00
87-89	B0928	-	-	-	130	27	1	TR	400,00		335,00	400,00
								ST	440,00		370,00	440,00
								RF	500,00		420,00	500,00
90-92	B0961	-	-	-	130	29	1	TR	415,00		345,00	415,00
								ST	455,00		380,00	455,00
								RF	520,00		430,00	520,00
97-99	B0929	-	-	-	136	30	1	TR	425,00		355,00	425,00
								ST	470,00		390,00	470,00
								RF	530,00		445,00	530,00

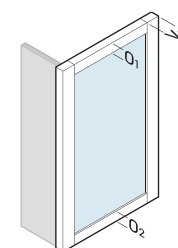

L1	
V <sub>2</sub>	36mm
O <sub>1</sub>	45mm
O <sub>2</sub>	45mm

SU MISURA/CUSTOM	PORTA DOOR	[€]	PARETE FISSA FIXED PANEL	[€]
Altezza/Height <sup>1</sup>	Vedi nota/See note <sup>3</sup>	-	40-210cm	+20%
Larghezza/Width <sup>2</sup>	Vedi nota/See note <sup>3</sup>	+20%	20-140cm	+20%
Altezza/Height Larghezza/Width <sup>2</sup>	Vedi nota/See note <sup>3</sup>	-	40-210cm 20-140cm	+20%
Altre forme Other shapes <sup>2</sup>		+30%		+30%

OPTIONAL	COD.	[€]
Profilo compensazione Compensation Profile	L01	60,00
	COM10C (+3cm)	90,00
	SAR-L95	90,00
	Porta/Door	100,00
	Parete Fissa/Fixed Panel	50,00

<sup>1</sup> Dal prezzo della misura di riferimento / From the price of selected size

<sup>2</sup> Dal prezzo della misura superiore / From the price of the larger size

<sup>3</sup> Contattare l'ufficio clienti per informazioni / Contact the customer service office for information

DISPONIBILITA' A MAGAZZINO / STOCK AVAILABILITY

1/2 Settimane/Weeks

2/3 Settimane/Weeks

3/4 Settimane/Weeks

+1 StarClean Optional

# CEE ART

PARETE FISSA  
FIXED PANEL



Per istruzioni di montaggio  
e ricambi inquadra il codice QR  
For assembly instructions  
and spare parts, scan the QR code



H. 195cm  
SP. 6mm

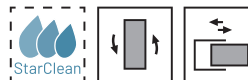

Parete fissa per abbinamenti. È possibile utilizzarla in abbinamento al modello di parete doccia selezionato per realizzare installazioni ad angolo o a tre lati quando possibile.

*Fixed panel for combinations. It can be used in combination with the selected shower enclosure model to create corner or three-sided installations where possible.*



### CONFIGURAZIONI IN ANGOLO ED A TRE LATI CORNER AND THREE-SIDED CONFIGURATIONS

È possibile realizzare configurazioni ad angolo ed a tre lati. Verificare le possibilità nelle pagine dei modelli specifici.

*It is possible to create corner and three-sided configurations; Check the options on the pages of the specific models.*

## ORIENTAMENTO E POSSIBILI COMBINAZIONI / ORIENTATION AND POSSIBLE CONFIGURATIONS

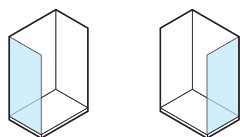

### PROFILI / PROFILES

#### STANDARD

ULU	Brillantato Lucido Brilliant Polished
SAR	Satinato Argento Silver Glazed Satin
L91	Bianco Opaco Matte White
L96	Nero Opaco Matte Black
L01	Bianco Lucido Glossy White

In finitura SAR, componentistica e maniglia sono in finitura cromata

*In SAR finish, the components and handle are in a chrome finish*

#### ATELIER

L95	Grigio Opaco Matte Grey
-----	----------------------------

### VETRO / GLASS

#### STANDARD

TR	Trasparente Transparent
ST	Stampato Printed
RF	Fascia H.100cm Band H.100cm

#### ON DEMAND

TE	Extrachiaro Extra Clear	TR +25%
TG	Trasparente Grigio Transparent Grey	TR +25%
AS	Satinato Satin	TR +25%
GS	Satinato Grigio Satin Grey	TR +25%
SY	Specchio Mirror <sup>3</sup>	TR +50%

**PARETE FISSA / FIXED PANEL**

L1 [cm]	COD.	A [cm]	B [cm]	C [cm]	[dm <sup>3</sup> ]	[kg]	[Pcs]	V	SAR			L95	
									ULU	L96	L91		L01
67-69	B0924	-	-	-	116	23	1	TR	365,00			305,00	365,00
								ST	400,00			335,00	400,00
								RF	455,00			380,00	455,00
70-72	B0925	-	-	-	117	23,5	1	TR	370,00			310,00	370,00
								ST	405,00			340,00	405,00
								RF	465,00			390,00	465,00
75-77	B0960	-	-	-	118	24	1	TR	375,00			315,00	375,00
								ST	415,00			345,00	415,00
								RF	470,00			395,00	470,00
77-79	B0926	-	-	-	122	25	1	TR	380,00			315,00	380,00
								ST	420,00			345,00	420,00
								RF	475,00			395,00	475,00
80-82	B0927	-	-	-	124	26	1	TR	390,00			325,00	390,00
								ST	430,00			360,00	430,00
								RF	490,00			405,00	490,00
87-89	B0928	-	-	-	130	27	1	TR	400,00			335,00	400,00
								ST	440,00			370,00	440,00
								RF	500,00			420,00	500,00
90-92	B0961	-	-	-	130	29	1	TR	415,00			345,00	415,00
								ST	455,00			380,00	455,00
								RF	520,00			430,00	520,00
97-99	B0929	-	-	-	136	30	1	TR	425,00			355,00	425,00
								ST	470,00			390,00	470,00
								RF	530,00			445,00	530,00

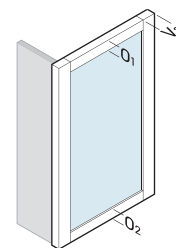

L1	
V <sub>2</sub>	36mm
O <sub>1</sub>	45mm
O <sub>2</sub>	45mm

SU MISURA/CUSTOM	PARETE FISSA FIXED PANEL	[€]
↕ Altezza/Height <sup>1</sup>	40-210cm	+20%
↔ Larghezza/Width <sup>2</sup>	20-140cm	+20%
↕ Altezza/Height ↔ Larghezza/Width <sup>2</sup>	40-210cm 20-140cm	+20%
Altre forme Other shapes <sup>2</sup>		+30%

OPTIONAL	COD.	[€]
Profilo compensazione Compensation Profile	L01	60,00
	COM10C (+3cm)	90,00
	SAR-L95	90,00
 StarClean	Parete Fissa/Fixed Panel	50,00

<sup>1</sup> Dal prezzo della misura di riferimento / From the price of selected size

<sup>2</sup> Dal prezzo della misura superiore / From the price of the larger size

<sup>3</sup> Contattare l'ufficio clienti per informazioni / Contact the customer service office for information

**DISPONIBILITA' A MAGAZZINO / STOCK AVAILABILITY**

1/2 Settimane/Weeks	2/3 Settimane/Weeks	3/4 Settimane/Weeks
+1 StarClean Optional		

# CEE ART SP











- > Parete doccia con telaio parziale
- > Vetro temperato 6mm per tutta la gamma
- > Trattamento anticalcare StarClean disponibile su richiesta
- > Estensibilità e regolazione fuori squadra del muro fino a 2cm
- > Maniglia e componentistica in finitura con il telaio
- > Profilo orizzontale inferiore assente per una maggiore ricercatezza estetica
- > Sgancio anta scorrevole per una agile pulizia del prodotto
- > Interasse maniglia 160 mm
- > Stampa digitale disponibile su tutti i vetri piani TR

- > Shower enclosure with partial frame
- > 6mm tempered glass across the entire range
- > StarClean anti-limescale treatment available upon request
- > Adjustability and wall misalignment correction up to 2cm
- > Handle and components matching the frame finish
- > No lower horizontal profile for a more refined aesthetic
- > Sliding door release for easy cleaning available on full sliding corner doors
- > Handle centre-to-centre distance 160 mm
- > Digital printing available on all flat glasses TR

# CEE ART SP

## PRODOTTI DELLA SERIE / PRODUCTS OF THE SERIES

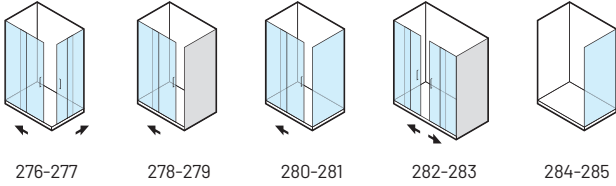

276-277

278-279

280-281

282-283

284-285

## PROFILI / PROFILES

### STANDARD



#### ULU

Brillianto Lucido  
Brilliant Polished

#### L91

Bianco Opaco  
Matte White

#### L96

Nero Opaco  
Matte Black

### ATELIER

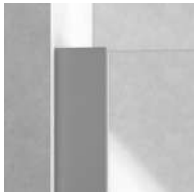

#### L95

Grigio Opaco  
Matte Grey

## VETRO / GLASS

### STANDARD



#### TR

Trasparente  
Transparent

#### ST

Stampato  
Printed

#### RF

Fascia H.100cm  
Band H.100cm

### ON DEMAND



#### TE

Extrachiaro  
Extra Clear

#### TG

Trasparente Grigio  
Transparent Grey

#### AS

Satinato  
Satin

#### GS

Satinato Grigio  
Satin Grey

#### SY

Specchio  
Mirror

# CEE ART SP

LATO ANGOLO  
SIDE CORNER



Per istruzioni di montaggio  
e ricambi inquadra il codice QR  
For assembly instructions  
and spare parts, scan the QR code



**H. 196,5cm**  
**SP. 6mm**

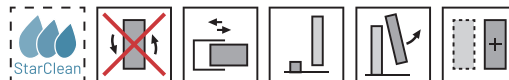

Parete doccia ad angolo a quattro ante, apertura ad ante scorrevoli nell'angolo del prodotto. Modello adatto per la maggior parte delle installazioni e disponibile in un'ampia gamma di dimensioni, soprattutto per chi vuole massimizzare le dimensioni d'ingresso.

Corner shower wall with four panels, featuring sliding doors at the corner of the product. Suitable for most installations and available in a wide range of sizes, especially for those looking to maximize the entry dimensions.

## CONFIGURAZIONE AD ANGOLO CORNER CONFIGURATION

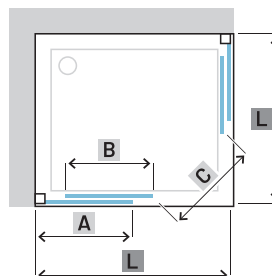

## CONFIGURAZIONE A TRE LATI THREE-SIDED CONFIGURATION

Per le configurazioni a tre lati considerare due volte la parete fissa (L1) specificando correttamente l'orientamento (destra o sinistra).  
For three-sided configurations, consider the fixed panel (L1) twice, specifying the correct orientation (right or left).

## ORIENTAMENTO E POSSIBILI COMBINAZIONI / ORIENTATION AND POSSIBLE CONFIGURATIONS

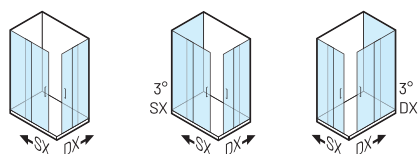

## PROFILI / PROFILES

STANDARD	
ULU	Brillantato Lucido Brilliant Polished
L91	Bianco Opaco Matte White
L96	Nero Opaco Matte Black

ATELIER	
L95	Grigio Opaco Matte Grey

## VETRO / GLASS

STANDARD	
TR	Trasparente Transparent
ST	Stampato Printed
RF	Fascia H.100cm Band H.100cm

ON DEMAND		
TE	Extrachiaro Extra Clear	TR +25%
TG	Trasparente Grigio Transparent Grey	TR +25%
AS	Satinato Satin	TR +25%
GS	Satinato Grigio Satin Grey	TR +25%
SY	Specchio Mirror <sup>3</sup>	TR +50%

## PORTA / DOOR

L [cm]	COD	A [cm]	B [cm]	C [cm]	[dm <sup>3</sup> ]	[kg]	[Pcs]	V			
									ULU	L96	L91
67,5-69,5	B0716	30,8-32,8	35,6	34	112	26	1	TR	570,00		570,00
								ST	625,00	625,00	
								RF	715,00	715,00	
70,5-72,5	B0714	33,3-35,3	35,6	36	115	28	1	TR	580,00		580,00
								ST	640,00	640,00	
								RF	725,00	725,00	
72,5-74,5	B0717	35,8-37,8	35,6	36	122	28	1	TR	585,00		585,00
								ST	645,00	645,00	
								RF	730,00	730,00	
75,5-77,5	B0715	35,8-37,8	38,1	40	124	30	1	TR	590,00		590,00
								ST	650,00	650,00	
								RF	740,00	740,00	
77,5-79,5	B0718	35,8-37,8	40,6	41	130	30	1	TR	595,00		595,00
								ST	655,00	655,00	
								RF	745,00	745,00	
80,5-82,5	B0719	38,3-40,3	40,6	44	136	30	1	TR	615,00		615,00
								ST	675,00	675,00	
								RF	770,00	770,00	
87,5-89,5	B0720	40,8-42,8	45,6	48	144	35	1	TR	630,00		630,00
								ST	695,00	695,00	
								RF	790,00	790,00	
90,5-92,5	B0721	43,3-45,3	45,6	48	152	35	1	TR	645,00		645,00
								ST	710,00	710,00	
								RF	805,00	805,00	
97,5-99,5	B0722	50,8-52,8	45,6	48	160	38	1	TR	655,00		655,00
								ST	720,00	720,00	
								RF	820,00	820,00	
117,5-119,5	B0723	70,8-72,8	45,6	48	175	41	1	TR	720,00		720,00
								ST	790,00	790,00	
								RF	900,00	900,00	

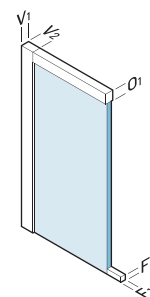

L	
V <sub>1</sub>	28mm
V <sub>2</sub>	40mm
O <sub>1</sub>	45mm
F <sub>1</sub>	10mm
F <sub>2</sub>	12mm

I valori della tabella prezzi si riferiscono ad un singolo lato: sommare l'importo dei due codici della misura desiderata per ottenere il prezzo totale di una doccia ad angolo quadrata o rettangolare. Apertura (C) determinata con due lati della stessa misura. Specificare il verso di apertura della parete doccia (SX o DX).

The prices in the table refer to a single side: add the amounts of the two codes for the desired size to get the total price of a square or rectangular corner shower. Opening (C) is determined by two sides of the same size. Specify the opening direction of the shower enclosure (SX or DX).

## PARETE FISSA / FIXED PANEL

H. 196,5cm  
SP. 6mm



L1 [cm]	COD.	A [cm]	B [cm]	C [cm]	[dm <sup>3</sup> ]	[kg]	[Pcs]	V			
									ULU	L96	L91
67,5-69,5	B0724	-	-	-	116	23	1	TR	380,00		380,00
								ST	420,00	420,00	
								RF	475,00	475,00	
70,5-72,5	B0725	-	-	-	117	23,5	1	TR	390,00		390,00
								ST	430,00	430,00	
								RF	490,00	490,00	
75,5-77,5	B0760	-	-	-	118	24	1	TR	395,00		395,00
								ST	435,00	435,00	
								RF	495,00	495,00	
77,5-79,5	B0726	-	-	-	122	25	1	TR	400,00		400,00
								ST	440,00	440,00	
								RF	500,00	500,00	
80,5-82,5	B0727	-	-	-	124	26	1	TR	410,00		410,00
								ST	450,00	450,00	
								RF	515,00	515,00	
87,5-89,5	B0728	-	-	-	130	27	1	TR	420,00		420,00
								ST	460,00	460,00	
								RF	525,00	525,00	
90,5-92,5	B0761	-	-	-	130	29	1	TR	435,00		435,00
								ST	480,00	480,00	
								RF	545,00	545,00	
97,5-99,5	B0729	-	-	-	136	30	1	TR	445,00		445,00
								ST	490,00	490,00	
								RF	555,00	555,00	

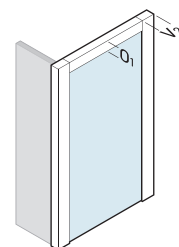

L1	
V <sub>2</sub>	40mm
O <sub>1</sub>	45mm

SU MISURA/CUSTOM	PORTA DOOR	[€]	PARETE FISSA FIXED PANEL	[€]
Altezza/Height <sup>1</sup>	50-210cm	+20%	50-210cm	+20%
Larghezza/Width <sup>2</sup>	50-140cm	+20%	15-120cm	+20%
Altezza/Height Larghezza/Width <sup>2</sup>	50-210cm 50-140cm	+20%	50-210cm 15-120cm	+20%
Altre forme Other shapes <sup>2</sup>		+30%		+30%

OPTIONAL	COD.	[€]
Profilo compensazione Compensation Profile	COM10B (+3cm)	90,00
	ULU-L91-L96 L95	90,00
	Porta/Door	50,00
	Parete Fissa/Fixed Panel	50,00

<sup>1</sup> Dal prezzo della misura di riferimento / From the price of selected size

<sup>2</sup> Dal prezzo della misura superiore / From the price of the larger size

<sup>3</sup> Contattare l'ufficio clienti per informazioni / Contact the customer service office for information

DISPONIBILITA' A MAGAZZINO / STOCK AVAILABILITY

1/2 Settimane/Weeks

2/3 Settimane/Weeks

3/4 Settimane/Weeks

+1 StarClean Optional

# CEE ART SP

PORTA SCORREVOLE  
SLIDING DOOR



Per istruzioni di montaggio  
e ricambi inquadra il codice QR  
For assembly instructions  
and spare parts, scan the QR code



**H. 196,5cm**  
**SP. 6mm**

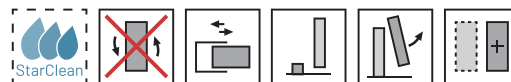

Parete doccia a due ante con apertura laterale scorrevole. Modello adatto per la maggior parte delle installazioni e disponibile in un'ampia gamma di dimensioni.

Shower wall with two panels and side sliding opening. Suitable for most installations and available in a wide range of sizes.

**CONFIGURAZIONE IN NICCHIA**  
**NICHE CONFIGURATION**

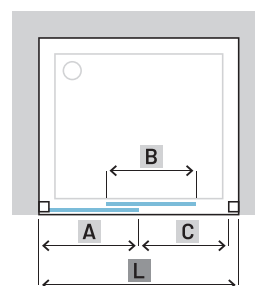

**CONFIGURAZIONE AD ANGOLO**  
**CORNER CONFIGURATION**

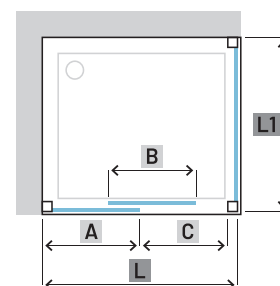

**CONFIGURAZIONE A TRE LATI**  
**THREE-SIDED CONFIGURATION**

Per le configurazioni a tre lati considerare due volte la parete fissa (L1) specificando correttamente l'orientamento (destra o sinistra).  
For three-sided configurations, consider the fixed panel (L1) twice, specifying the correct orientation (right or left).

## ORIENTAMENTO E POSSIBILI COMBINAZIONI / ORIENTATION AND POSSIBLE CONFIGURATIONS

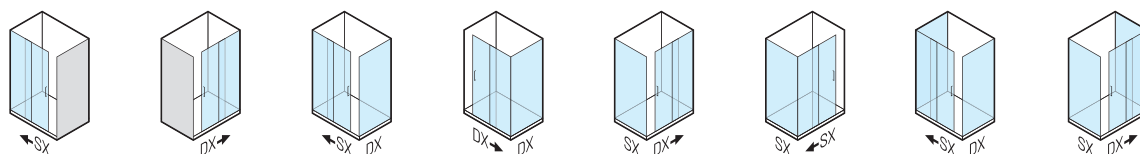

### PROFILI / PROFILES

STANDARD	
ULU	Brillantato Lucido Brilliant Polished
L91	Bianco Opaco Matte White
L96	Nero Opaco Matte Black

ATELIER	
L95	Grigio Opaco Matte Grey

### VETRO / GLASS

STANDARD	
TR	Trasparente Transparent
ST	Stampato Printed
RF	Fascia H.100cm Band H.100cm

### ON DEMAND

TE	Extrachiaro Extra Clear	TR +25%
TG	Trasparente Grigio Transparent Grey	TR +25%
AS	Satinato Satin	TR +25%
GS	Satinato Grigio Satin Grey	TR +25%
SY	Specchio Mirror <sup>3</sup>	TR +50%

## PORTA / DOOR

L [cm]	COD	A [cm]	B [cm]	C [cm]	[dm3]	[kg]	[Pcs]	V			
									ULU	L96	L91
97-101	B0780	45,3-47,3	48,9	37	116	35	1	TR	805,00	805,00	805,00
								ST	885,00	885,00	885,00
								RF	1.005,00	1.005,00	1.005,00
107-111	B0781	55,3-57,3	48,9	37	124	37	1	TR	825,00	825,00	825,00
								ST	910,00	910,00	910,00
								RF	1.030,00	1.030,00	1.030,00
117-121	B0783	55,3-57,3	58,9	47	125	38	1	TR	855,00	855,00	855,00
								ST	940,00	940,00	940,00
								RF	1.070,00	1.070,00	1.070,00
127-131	B0785	65,1-67,1	58,9	47	131	39	2	TR	870,00	870,00	870,00
								ST	955,00	955,00	955,00
								RF	1.090,00	1.090,00	1.090,00
137-141	B0786	65,1-67,1	69,1	57	138	40	2	TR	920,00	920,00	920,00
								ST	1.010,00	1.010,00	1.010,00
								RF	1.150,00	1.150,00	1.150,00
147-151	B0787	69,6-71,6	74,6	63	143	41	2	TR	950,00	950,00	950,00
								ST	1.045,00	1.045,00	1.045,00
								RF	1.190,00	1.190,00	1.190,00
157-161	B0789	76,6-78,6	77,6	66	149	42	2	TR	970,00	970,00	970,00
								ST	1.065,00	1.065,00	1.065,00
								RF	1.215,00	1.215,00	1.215,00
167-171	B0790	80,1-82,1	84,1	73	149	44	2	TR	1.000,00	1.000,00	1.000,00
								ST	1.100,00	1.100,00	1.100,00
								RF	1.250,00	1.250,00	1.250,00

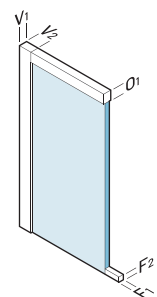

L	
V <sub>1</sub>	45mm
V <sub>2</sub>	40mm
O <sub>1</sub>	45mm
F <sub>1</sub>	10mm
F <sub>2</sub>	12mm

## PARETE FISSA / FIXED PANEL

H. 196,5cm  
SP. 6mm



L1 [cm]	COD.	A [cm]	B [cm]	C [cm]	[dm3]	[kg]	[Pcs]	V			
									ULU	L96	L91
67,5-69,5	B0724	-	-	-	116	23	1	TR	380,00	380,00	380,00
								ST	420,00	420,00	420,00
								RF	475,00	475,00	475,00
70,5-72,5	B0725	-	-	-	117	23,5	1	TR	390,00	390,00	390,00
								ST	430,00	430,00	430,00
								RF	490,00	490,00	490,00
75,5-77,5	B0760	-	-	-	118	24	1	TR	395,00	395,00	395,00
								ST	435,00	435,00	435,00
								RF	495,00	495,00	495,00
77,5-79,5	B0726	-	-	-	122	25	1	TR	400,00	400,00	400,00
								ST	440,00	440,00	440,00
								RF	500,00	500,00	500,00
80,5-82,5	B0727	-	-	-	124	26	1	TR	410,00	410,00	410,00
								ST	450,00	450,00	450,00
								RF	515,00	515,00	515,00
87,5-89,5	B0728	-	-	-	130	27	1	TR	420,00	420,00	420,00
								ST	460,00	460,00	460,00
								RF	525,00	525,00	525,00
90,5-92,5	B0761	-	-	-	130	29	1	TR	435,00	435,00	435,00
								ST	480,00	480,00	480,00
								RF	545,00	545,00	545,00
97,5-99,5	B0729	-	-	-	136	30	1	TR	445,00	445,00	445,00
								ST	490,00	490,00	490,00
								RF	555,00	555,00	555,00

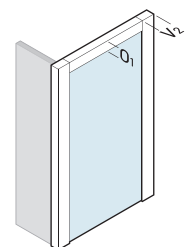

L1	
V <sub>2</sub>	40mm
O <sub>1</sub>	45mm

SU MISURA/CUSTOM	PORTA DOOR	[€]	PARETE FISSA FIXED PANEL	[€]
Altezza/Height <sup>1</sup>	50-210cm	+20%	50-210cm	+20%
Larghezza/Width <sup>2</sup>	80-180cm	+20%	15-120cm	+20%
Altezza/Height Larghezza/Width <sup>2</sup>	50-210cm 80-180cm	+20%	50-210cm 15-120cm	+20%
Altre forme Other shapes <sup>2</sup>		+30%		+30%

OPTIONAL	COD.	[€]
Profilo compensazione Compensation Profile	COM10B (+3cm)	90,00
	ULU-L91-L96 L95	90,00
	Porta/Door	50,00
	Parete Fissa/Fixed Panel	50,00

<sup>1</sup> Dal prezzo della misura di riferimento / From the price of selected size

<sup>2</sup> Dal prezzo della misura superiore / From the price of the larger size

<sup>3</sup> Contattare l'ufficio clienti per informazioni / Contact the customer service office for information

DISPONIBILITA' A MAGAZZINO / STOCK AVAILABILITY

1/2 Settimane/Weeks

2/3 Settimane/Weeks

3/4 Settimane/Weeks

+1 StarClean Optional

# CEE ART SP

PORTA SCORREVOLE + PARETE FISSA DEDICATA  
SLIDING DOOR + DEDICATED FIXED PANEL



Per istruzioni di montaggio  
e ricambi inquadra il codice QR  
For assembly instructions  
and spare parts, scan the QR code



**H. 196,5cm**  
**SP. 6mm**

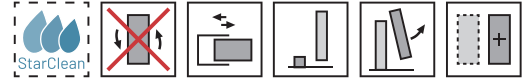

Parete doccia a due ante con apertura laterale scorrevole con parete fissa dedicata per configurazioni ad angolo. Modello adatto per la maggior parte delle installazioni e disponibile in un'ampia gamma di dimensioni.

Shower enclosure with two sliding doors and a dedicated fixed panel for corner configurations. A model suitable for most installations and available in a wide range of sizes.

### CONFIGURAZIONE AD ANGOLO CORNER CONFIGURATION

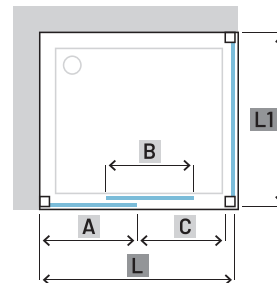

### CONFIGURAZIONI A TRE LATI THREE-SIDED CONFIGURATIONS

Per configurazioni a tre lati utilizzare una parete fissa dedicata e una parete fissa standard Cee Art SP (B0724>0729).

For three-sided configurations, use a dedicated fixed panel and a standard Cee Art SP fixed panel (B0724>0729).

### ORIENTAMENTO E POSSIBILI COMBINAZIONI / ORIENTATION AND POSSIBLE CONFIGURATIONS

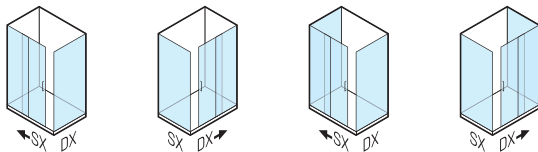

### PROFILI / PROFILES

STANDARD		ATELIER	
ULU	Brillantato Lucido Brilliant Polished	L95	Grigio Opaco Matte Grey
L91	Bianco Opaco Matte White		
L96	Nero Opaco Matte Black		

### VETRO / GLASS

STANDARD		
TR	Trasparente Transparent	
ST	Stampato Printed	
RF	Fascia H.100cm Band H.100cm	
ON DEMAND		
TE	Extrachiaro Extra Clear	TR +25%
TG	Trasparente Grigio Transparent Grey	TR +25%
AS	Satinato Satin	TR +25%
GS	Satinato Grigio Satin Grey	TR +25%
SY	Specchio Mirror <sup>3</sup>	TR +50%

**PORTA / DOOR**

L [cm]	COD	A [cm]	B [cm]	C [cm]	[dm3]	[kg]	[Pcs]	V			
									ULU	L96	L91
97,5-99,5	B0770	48,6-50,6	48,9	38	116	35	1	TR	780,00		780,00
								ST	860,00	860,00	
								RF	975,00	975,00	
107,5-109,5	B0771	58,6-60,6	48,9	38	124	37	1	TR	805,00		805,00
								ST	885,00	885,00	
								RF	1.005,00	1.005,00	
117,5-119,5	B0773	58,6-60,6	58,9	48	125	38	1	TR	825,00		825,00
								ST	910,00	910,00	
								RF	1.030,00	1.030,00	
127,5-129,5	B0775	68,6-70,6	58,9	48	131	39	2	TR	850,00		850,00
								ST	935,00	935,00	
								RF	1.065,00	1.065,00	
137,5-139,5	B0776	68,6-70,6	69,1	58	138	40	2	TR	895,00		895,00
								ST	985,00	985,00	
								RF	1.120,00	1.120,00	
147,5-149,5	B0777	73,3-75,3	74,6	63	143	41	2	TR	920,00		920,00
								ST	1.010,00	1.010,00	
								RF	1.150,00	1.150,00	
157,5-159,5	B0779	80,1-82,1	77,6	66	149	42	2	TR	955,00		955,00
								ST	1.050,00	1.050,00	
								RF	1.195,00	1.195,00	
167,5-169,5	B0772	83,6-85,6	84,1	73	149	44	2	TR	990,00		990,00
								ST	1.090,00	1.090,00	
								RF	1.240,00	1.240,00	

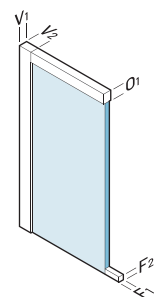

L
V <sub>1</sub> 28mm
V <sub>2</sub> 40mm
O <sub>1</sub> 45mm
F <sub>1</sub> 10mm
F <sub>2</sub> 12mm

**PARETE FISSA DEDICATA / DEDICATED FIXED PANEL**

 H. 196,5cm  
 SP. 6mm

L1 [cm]	COD.	A [cm]	B [cm]	C [cm]	[dm3]	[kg]	[Pcs]	V			
									ULU	L96	L91
67,5-69,5	B0791	-	-	-	116	35	1	TR	380,00		380,00
								ST	420,00	420,00	
								RF	475,00	475,00	
70,5-72,5	B0792	-	-	-	124	37	1	TR	390,00		390,00
								ST	430,00	430,00	
								RF	490,00	490,00	
75,5-77,5	B0793	-	-	-	125	38	1	TR	395,00		395,00
								ST	435,00	435,00	
								RF	495,00	495,00	
77,5-79,5	B0794	-	-	-	131	39	1	TR	400,00		400,00
								ST	440,00	440,00	
								RF	500,00	500,00	
80,5-82,5	B0795	-	-	-	138	40	1	TR	410,00		410,00
								ST	450,00	450,00	
								RF	515,00	515,00	
87,5-89,5	B0796	-	-	-	143	41	1	TR	420,00		420,00
								ST	460,00	460,00	
								RF	525,00	525,00	
90,5-92,5	B0797	-	-	-	149	42	1	TR	435,00		435,00
								ST	480,00	480,00	
								RF	545,00	545,00	
97,5-99,5	B0798	-	-	-	149	44	1	TR	445,00		445,00
								ST	490,00	490,00	
								RF	555,00	555,00	

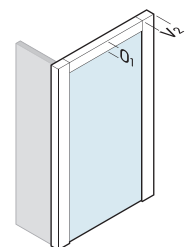

L1
V <sub>2</sub> 40mm
O <sub>1</sub> 45mm

SU MISURA/CUSTOM	PORTA DOOR	[€]	PARETE FISSA FIXED PANEL	[€]
Altezza/Height <sup>1</sup>	50-210cm	+20%	50-210cm	+20%
Larghezza/Width <sup>2</sup>	80-180cm	+20%	15-120cm	+20%
Altezza/Height Larghezza/Width <sup>2</sup>	50-210cm 80-180cm	+20%	50-210cm 15-120cm	+20%
Altre forme Other shapes <sup>2</sup>		+30%		+30%

OPTIONAL	COD.	[€]
Profilo compensazione Compensation Profile	COM10B (+3cm)	90,00
StarClean	Porta/Door	50,00
	Parete Fissa/Fixed Panel	50,00

<sup>1</sup> Dal prezzo della misura di riferimento / From the price of selected size

<sup>2</sup> Dal prezzo della misura superiore / From the price of the larger size

<sup>3</sup> Contattare l'ufficio clienti per informazioni / Contact the customer service office for information

**DISPONIBILITA' A MAGAZZINO / STOCK AVAILABILITY**

1/2 Settimane/Weeks

2/3 Settimane/Weeks

3/4 Settimane/Weeks

+1 StarClean Optional

# CEE ART SP

DOPPIA PORTA SCORREVOLE  
DOUBLE SLIDING DOOR



Per istruzioni di montaggio  
e ricambi inquadra il codice QR  
For assembly instructions  
and spare parts, scan the QR code



**H. 196,5cm**  
**SP. 6mm**

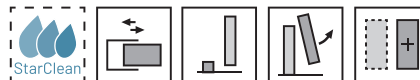

Parete doccia a quattro ante con apertura centrale. L'apertura è centrale data dalle due ante centrali scorrevoli in modo contrapposto. Modello adatto per installazioni di generose dimensioni.

Shower enclosure with four panels and a central opening. The opening is created by the two central sliding doors, which move in opposite directions. This model is suitable for large-scale installations.

**CONFIGURAZIONE IN NICCHIA**  
**NICHE CONFIGURATION**

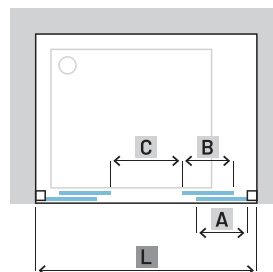

**CONFIGURAZIONE AD ANGOLO**  
**CORNER CONFIGURATION**

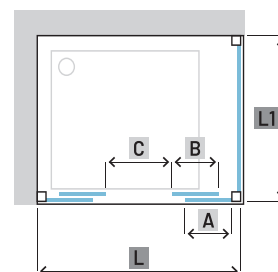

**CONFIGURAZIONE A TRE LATI**  
**THREE-SIDED CONFIGURATION**

Per le configurazioni a tre lati considerare due volte la parete fissa (L1) specificando correttamente l'orientamento (destra o sinistra).  
For three-sided configurations, consider the fixed panel (L1) twice, specifying the correct orientation (right or left).

## ORIENTAMENTO E POSSIBILI COMBINAZIONI / ORIENTATION AND POSSIBLE CONFIGURATIONS

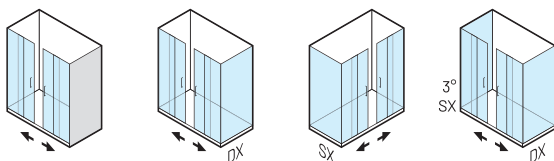

### PROFILI / PROFILES

STANDARD	
ULU	Brillantato Lucido Brilliant Polished
L91	Bianco Opaco Matte White
L96	Nero Opaco Matte Black

ATELIER	
L95	Grigio Opaco Matte Grey

### VETRO / GLASS

STANDARD	
TR	Trasparente Transparent
ST	Stampato Printed
RF	Fascia H.100cm Band H.100cm

ON DEMAND		
TE	Extrachiaro Extra Clear	TR +25%
TG	Trasparente Grigio Transparent Grey	TR +25%
AS	Satinato Satin	TR +25%
GS	Satinato Grigio Satin Grey	TR +25%
SY	Specchio Mirror <sup>3</sup>	TR +50%

## PORTA / DOOR

L [cm]	COD	A [cm]	B [cm]	C [cm]	[dm3]	[kg]	[Pcs]	V				L95
									ULU	L96	L91	
137-141	B0744	33,3-35,3	37,1	52	161	51	2	TR	1.095,00			1.095,00
								ST	1.205,00		1.205,00	
								RF	1.370,00		1.370,00	
142-146	B0745	35,8-37,8	37,1	52	165	52	2	TR	1.105,00			1.105,00
								ST	1.215,00		1.215,00	
								RF	1.380,00		1.380,00	
157-161	B0746	38,3-40,3	42,1	62	170	54	2	TR	1.145,00			1.145,00
								ST	1.260,00		1.260,00	
								RF	1.430,00		1.430,00	
162-166	B0740	40,8-42,8	42,1	62	172	55	2	TR	1.160,00			1.160,00
								ST	1.275,00		1.275,00	
								RF	1.450,00		1.450,00	
167-171	B0747	40,8-42,8	44,6	67	173	56	2	TR	1.165,00			1.165,00
								ST	1.280,00		1.280,00	
								RF	1.455,00		1.455,00	
172-176	B0741	43,3-45,3	44,6	67	178	57	2	TR	1.175,00			1.175,00
								ST	1.295,00		1.295,00	
								RF	1.470,00		1.470,00	
177-181	B0748	43,3-45,3	47,1	72	183	58	2	TR	1.190,00			1.190,00
								ST	1.310,00		1.310,00	
								RF	1.490,00		1.490,00	

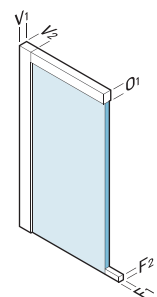

L	
V <sub>1</sub>	45mm
V <sub>2</sub>	40mm
O <sub>1</sub>	45mm
F <sub>1</sub>	10mm
F <sub>2</sub>	12mm

## PARETE FISSA / FIXED PANEL

H. 196,5cm  
SP. 6mm

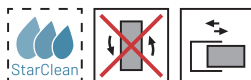

L1 [cm]	COD.	A [cm]	B [cm]	C [cm]	[dm3]	[kg]	[Pcs]	V				L95
									ULU	L96	L91	
67,5-69,5	B0724	-	-	-	116	23	1	TR	380,00			380,00
								ST	420,00		420,00	
								RF	475,00		475,00	
70,5-72,5	B0725	-	-	-	117	23,5	1	TR	390,00			390,00
								ST	430,00		430,00	
								RF	490,00		490,00	
75,5-77,5	B0760	-	-	-	118	24	1	TR	395,00			395,00
								ST	435,00		435,00	
								RF	495,00		495,00	
77,5-79,5	B0726	-	-	-	122	25	1	TR	400,00			400,00
								ST	440,00		440,00	
								RF	500,00		500,00	
80,5-82,5	B0727	-	-	-	124	26	1	TR	410,00			410,00
								ST	450,00		450,00	
								RF	515,00		515,00	
87,5-89,5	B0728	-	-	-	130	27	1	TR	420,00			420,00
								ST	460,00		460,00	
								RF	525,00		525,00	
90,5-92,5	B0761	-	-	-	130	29	1	TR	435,00			435,00
								ST	480,00		480,00	
								RF	545,00		545,00	
97,5-99,5	B0729	-	-	-	136	30	1	TR	445,00			445,00
								ST	490,00		490,00	
								RF	555,00		555,00	

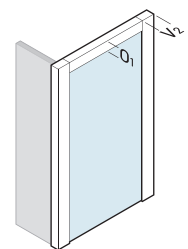

L1	
V <sub>2</sub>	40mm
O <sub>1</sub>	45mm

SU MISURA/CUSTOM	PORTA DOOR	[€]	PARETE FISSA FIXED PANEL	[€]
Altezza/Height <sup>1</sup>	50-210cm	+20%	50-210cm	+20%
Larghezza/Width <sup>2</sup>	100-200cm	+20%	15-120cm	+20%
Altezza/Height Larghezza/Width <sup>2</sup>	50-210cm 100-200cm	+20%	50-210cm 15-120cm	+20%
Altre forme Other shapes <sup>2</sup>		+30%		+30%

OPTIONAL	COD.	[€]
Profilo compensazione Compensation Profile	COM10B (+3cm)	90,00
	ULU-L91-L96 L95	90,00
	Porta/Door	100,00
	Parete Fissa/Fixed Panel	50,00

<sup>1</sup> Dal prezzo della misura di riferimento / From the price of selected size

<sup>2</sup> Dal prezzo della misura superiore / From the price of the larger size

<sup>3</sup> Contattare l'ufficio clienti per informazioni / Contact the customer service office for information

DISPONIBILITA' A MAGAZZINO / STOCK AVAILABILITY

1/2 Settimane/Weeks

2/3 Settimane/Weeks

3/4 Settimane/Weeks

+1 StarClean Optional

# CEE ART SP

PARETE FISSA  
FIXED PANEL



Per istruzioni di montaggio  
e ricambi inquadra il codice QR  
For assembly instructions  
and spare parts, scan the QR code



**H. 196,5cm**  
**SP. 6mm**

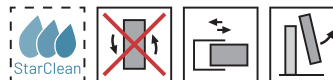

Parete fissa per abbinamenti. È possibile utilizzarla in abbinamento al modello di parete doccia selezionato per realizzare installazioni ad angolo o a tre lati quando possibile.

*Fixed panel for combinations. It can be used in combination with the selected shower enclosure model to create corner or three-sided installations where possible.*



## CONFIGURAZIONI IN ANGOLO ED A TRE LATI CORNER AND THREE-SIDED CONFIGURATIONS

È possibile realizzare configurazioni ad angolo ed a tre lati. Verificare le possibilità nelle pagine dei modelli specifici.

*It is possible to create corner and three-sided configurations; Check the options on the pages of the specific models.*

## ORIENTAMENTO E POSSIBILI COMBINAZIONI / ORIENTATION AND POSSIBLE CONFIGURATIONS

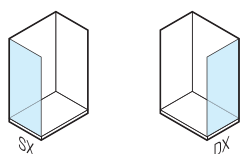

### PROFILI / PROFILES

STANDARD	
ULU	Brillantato Lucido Brilliant Polished
L91	Bianco Opaco Matte White
L96	Nero Opaco Matte Black

ATELIER	
L95	Grigio Opaco Matte Grey

### VETRO / GLASS

STANDARD	
TR	Trasparente Transparent
ST	Stampato Printed
RF	Fascia H.100cm Band H.100cm

ON DEMAND		
TE	Extrachiaro Extra Clear	TR +25%
TG	Trasparente Grigio Transparent Grey	TR +25%
AS	Satinato Satin	TR +25%
GS	Satinato Grigio Satin Grey	TR +25%
SY	Specchio Mirror <sup>3</sup>	TR +50%

**PARETE FISSA/FIXED PANEL**

L1 [cm]	COD.	A [cm]	B [cm]	C [cm]	[dm <sup>3</sup> ]	[kg]	[Pcs]	V	ULU	L96	L91	L95
67,5-69,5	B0724	-	-	-	116	23	1	TR	380,00			380,00
								ST	420,00		420,00	
								RF	475,00		475,00	
70,5-72,5	B0725	-	-	-	117	23,5	1	TR	390,00			390,00
								ST	430,00		430,00	
								RF	490,00		490,00	
75,5-77,5	B0760	-	-	-	118	24	1	TR	395,00			395,00
								ST	435,00		435,00	
								RF	495,00		495,00	
77,5-79,5	B0726	-	-	-	122	25	1	TR	400,00			400,00
								ST	440,00		440,00	
								RF	500,00		500,00	
80,5-82,5	B0727	-	-	-	124	26	1	TR	410,00			410,00
								ST	450,00		450,00	
								RF	515,00		515,00	
87,5-89,5	B0728	-	-	-	130	27	1	TR	420,00			420,00
								ST	460,00		460,00	
								RF	525,00		525,00	
90,5-92,5	B0761	-	-	-	130	29	1	TR	435,00			435,00
								ST	480,00		480,00	
								RF	545,00		545,00	
97,5-99,5	B0729	-	-	-	136	30	1	TR	445,00			445,00
								ST	490,00		490,00	
								RF	555,00		555,00	

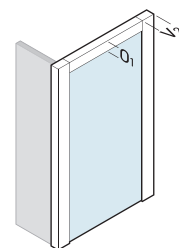

<b>L1</b>	
V <sub>2</sub>	40mm
O <sub>1</sub>	45mm

SU MISURA/CUSTOM	PARETE FISSA FIXED PANEL	[€]
↕ Altezza/Height <sup>1</sup>	50-210cm	+20%
↔ Larghezza/Width <sup>2</sup>	15-120cm	+20%
↕ Altezza/Height ↔ Larghezza/Width <sup>2</sup>	50-210cm 15-120cm	+20%
Altre forme Other shapes <sup>2</sup>		+30%

OPTIONAL	COD.	[€]
Profilo compensazione Compensation Profile	<b>COM10B</b> (+3cm)	90,00
 StarClean	ULU-L91-L96 L95	90,00
	Parete Fissa/Fixed Panel	50,00

<sup>1</sup> Dal prezzo della misura di riferimento / From the price of selected size

<sup>2</sup> Dal prezzo della misura superiore / From the price of the larger size

<sup>3</sup> Contattare l'ufficio clienti per informazioni / Contact the customer service office for information

**DISPONIBILITA' A MAGAZZINO / STOCK AVAILABILITY**

1/2 Settimane/Weeks	2/3 Settimane/Weeks	3/4 Settimane/Weeks
+1 StarClean Optional		

# AMERICA QUATTRO







- > Parete doccia con telaio
- > Vetro temperato 4mm per tutta la gamma
- > Trattamento anticalcare StarClean disponibile su richiesta
- > Estensibilità e regolazione fuori squadra del muro fino a 4cm per tutta la gamma ad eccezione di angolo porte scorrevoli completo (fino a 2cm)
- > Maniglia e componentistica in finitura con il telaio
- > Sgancio anta scorrevole per una agile pulizia del prodotto disponibile su angolo porte scorrevoli completo
- > Profilo magnetico di chiusura in alluminio

- > Shower enclosure with frame
- > 4mm tempered glass across the entire range
- > StarClean anti-limescale treatment available upon request
- > Adjustability and wall misalignment correction up to 4cm for the entire range, except for full sliding corner doors (up to 2cm)
- > Handle and components matching the frame finish
- > Sliding door release for easy cleaning available on full sliding corner doors
- > Magnetic aluminum closing profile

# AMERICA QUATTRO

## PRODOTTI DELLA SERIE / PRODUCTS OF THE SERIES

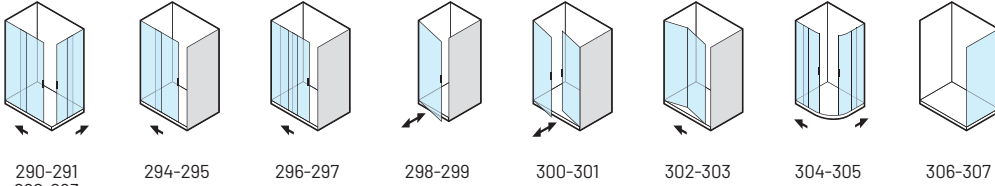

290-291  
292-293

294-295

296-297

298-299

300-301

302-303

304-305

306-307

## PROFILI / PROFILES

### STANDARD



**ULU**

Brillantato Lucido  
Brilliant Polished

**L91**

Bianco Opaco  
Matte White

**L96**

Nero Opaco  
Matte Black

## VETRO / GLASS

### STANDARD



**TR**

Trasparente  
Transparent

**ST**

Stampato  
Printed

**AS**

Satinato  
Satin

# AMERICA QUATTRO

LATO ANGOLO  
SIDE CORNER



Per istruzioni di montaggio  
e ricambi inquadra il codice QR  
For assembly instructions  
and spare parts, scan the QR code

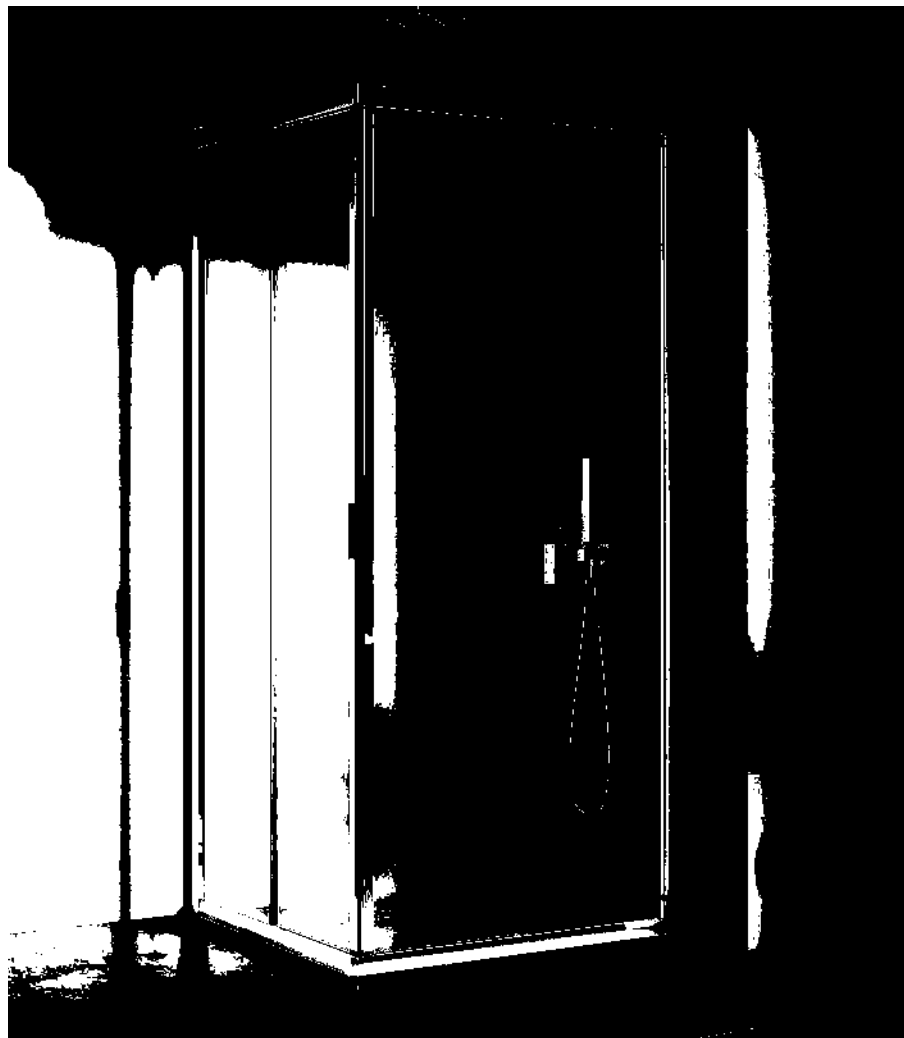

H. 190cm  
SP. 4mm

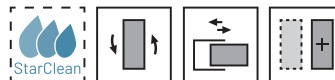

Parete doccia ad angolo a quattro ante, apertura ad ante scorrevoli nell'angolo del prodotto. Modello adatto per la maggior parte delle installazioni e disponibile in un'ampia gamma di dimensioni, soprattutto per chi vuole massimizzare le dimensioni d'ingresso.

*Corner shower wall with four panels, featuring sliding doors at the corner of the product. Suitable for most installations and available in a wide range of sizes, especially for those looking to maximize the entry dimensions.*

## CONFIGURAZIONE AD ANGOLO CORNER CONFIGURATION

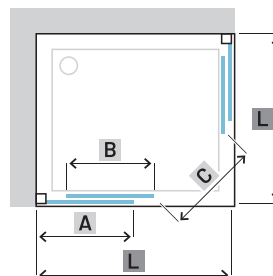

## CONFIGURAZIONE A TRE LATI THREE-SIDED CONFIGURATION

Per le configurazioni a tre lati considerare la parete fissa (L1).  
For three-sided configurations, consider the fixed panel (L1).

## ORIENTAMENTO E POSSIBILI COMBINAZIONI / ORIENTATION AND POSSIBLE CONFIGURATIONS

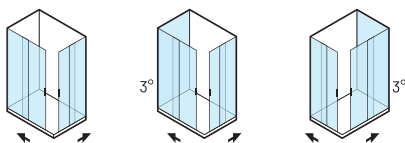

### PROFILI / PROFILES

STANDARD	
ULU	Brillantato Lucido Brilliant Polished
L91	Bianco Opaco Matte White
L96	Nero Opaco Matte Black

### VETRO / GLASS

STANDARD	
TR	Trasparente Transparent
ST	Stampato Printed
AS	Satinato Satin

## PORTA / DOOR

L [cm]	COD.	A [cm]	B [cm]	C [cm]	[dm <sup>3</sup> ]	[kg]	[Pcs]	V	ULU	L91	L96
67-71	B6482	33,9-37,9	31,7	36	118	19	1	TR	360,00	300,00	
								ST	380,00	315,00	
								AS	395,00	330,00	
73-77	B6484	36,9-40,9	34,7	40	122	20	1	TR	360,00	300,00	
								ST	380,00	315,00	
								AS	395,00	330,00	
77-81	B6485	38,9-42,9	36,7	43	128	21	1	TR	365,00	305,00	
								ST	385,00	320,00	
								AS	400,00	335,00	
83-87	B6487	41,9-45,9	39,7	47	137	22	1	TR	365,00	305,00	
								ST	385,00	320,00	
								AS	400,00	335,00	
87-91	B6488	43,9-47,9	41,7	50	140	23	1	TR	380,00	315,00	
								ST	400,00	330,00	
								AS	420,00	345,00	
93-97	B6490	47,1-51,1	44,9	54,5	145	24	1	TR	380,00	315,00	
								ST	400,00	330,00	
								AS	420,00	345,00	
97-101	B6491	48,9-52,9	46,7	57	151	25	1	TR	415,00	345,00	
								ST	435,00	360,00	
								AS	455,00	380,00	
103-107	B6493	52,1-56,1	49,9	61,5	155	26	1	TR	415,00	345,00	
								ST	435,00	360,00	
								AS	455,00	380,00	
107-111	B6494	53,9-57,9	51,7	64	160	27	1	TR	420,00	350,00	
								ST	440,00	370,00	
								AS	460,00	385,00	
117-121	B6497	58,9-62,9	56,7	71	168	28	1	TR	460,00	385,00	
								ST	485,00	405,00	
								AS	505,00	425,00	

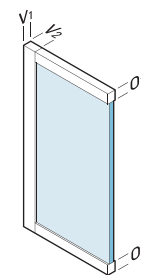

L	
V <sub>1</sub>	21mm
V <sub>2</sub>	50mm
O <sub>1</sub>	45mm
O <sub>2</sub>	45mm

! I valori della tabella prezzi si riferiscono ad un singolo lato: sommare l'importo dei due codici della misura desiderata per ottenere il prezzo totale di una doccia ad angolo quadrata o rettangolare. Apertura (C) determinata con due lati della stessa misura.

The prices in the table refer to a single side: add the amounts of the two codes for the desired size to get the total price of a square or rectangular corner shower. Opening (C) is determined by two sides of the same size.

## PARETE FISSA / FIXED PANEL

H. 190cm  
SP. 4mm

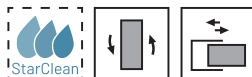

L1 [cm]	COD.	A [cm]	B [cm]	C [cm]	[dm <sup>3</sup> ]	[kg]	[Pcs]	V	ULU	L91	L96
63-67	B6421	-	-	-	118	15	1	TR	340,00	285,00	
								ST	355,00	300,00	
								AS	375,00	315,00	
67-71	B6422	-	-	-	121	16	1	TR	340,00	285,00	
								ST	355,00	300,00	
								AS	375,00	315,00	
73-77	B6424	-	-	-	123	17	1	TR	340,00	285,00	
								ST	355,00	300,00	
								AS	375,00	315,00	
77-81	B6425	-	-	-	126	18	1	TR	360,00	300,00	
								ST	380,00	315,00	
								AS	395,00	330,00	
83-87	B6427	-	-	-	130	19	1	TR	360,00	300,00	
								ST	380,00	315,00	
								AS	395,00	330,00	
87-91	B6428	-	-	-	132	20	1	TR	380,00	315,00	
								ST	400,00	330,00	
								AS	420,00	345,00	
97-101	B6429	-	-	-	135	21	1	TR	380,00	315,00	
								ST	400,00	330,00	
								AS	420,00	345,00	

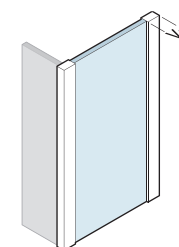

L1	
V <sub>2</sub>	55mm

SU MISURA/CUSTOM	PORTA DOOR	[€]	PARETE FISSA FIXED PANEL	[€]
↕ Altezza/Height <sup>1</sup>	50-200cm	+20%	50-200cm	+20%
↔ Larghezza/Width <sup>2</sup>	50-130cm	+20%	17-120cm	+20%
↕ Altezza/Height	50-200cm	+20%	50-200cm	+20%
↔ Larghezza/Width <sup>2</sup>	50-130cm	+20%	17-120cm	+20%
Altre forme Other shapes <sup>2</sup>		+30%		+30%

OPTIONAL	COD.	[€]
Profilo compensazione Compensation Profile	COM7A (+4cm)	90,00
	ULU L91-L96	90,00
StarClean	Porta/Door	50,00
	Parete Fissa/Fixed Panel	50,00

<sup>1</sup> Dal prezzo della misura di riferimento/From the price of selected size

<sup>2</sup> Dal prezzo della misura superiore/From the price of the larger size

DISPONIBILITA' A MAGAZZINO / STOCK AVAILABILITY

1/2 Settimane/Weeks	2/3 Settimane/Weeks	3/4 Settimane/Weeks
+1 StarClean Optional		

# AMERICA QUATTRO

ANGOLO DUE PORTE SCORREVOLI COMPLETO  
COMPLETE CORNER TWO SLIDING DOORS



Per istruzioni di montaggio  
e ricambi inquadra il codice QR  
For assembly instructions  
and spare parts, scan the QR code



H. 190cm  
SP. 4mm

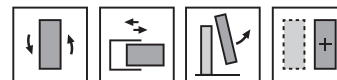

Parete doccia ad angolo a quattro ante, apertura ad ante scorrevoli nell'angolo del prodotto. Modello adatto per la maggior parte delle installazioni e disponibile in un'ampia gamma di dimensioni, soprattutto per chi vuole massimizzare le dimensioni d'ingresso.

*Corner shower wall with four panels, featuring sliding doors at the corner of the product. Suitable for most installations and available in a wide range of sizes, especially for those looking to maximize the entry dimensions.*

## CONFIGURAZIONE AD ANGOLO CORNER CONFIGURATION

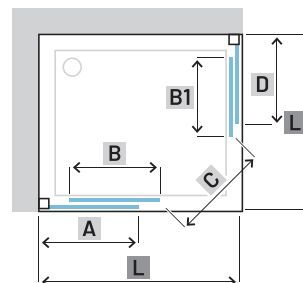

### CONFIGURAZIONE A TRE LATI THREE-SIDED CONFIGURATION

Non è possibile realizzare configurazioni a tre lati.  
*It is not possible to create three-sided configurations.*

## ORIENTAMENTO E POSSIBILI COMBINAZIONI / ORIENTATION AND POSSIBLE CONFIGURATIONS

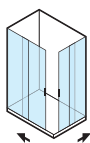

### PROFILI / PROFILES

STANDARD	
ULU	Brillantato cromo Brilliant Chrome
L91	Bianco opaco Matte White

### VETRO / GLASS

STANDARD	
TR	Trasparente Transparent
ST	Stampato Printed

**PORTA / DOOR**

L [cm]	COD.	A [cm]	B [cm]	B1 [cm]	C [cm]	D [cm]	[dm <sup>3</sup> ]	[kg]	[Pcs]	V	ULU	L91
67-69	B6412	33,9-35,9	31,7	31,7	36	33,9-35,9	170	27	1	TR	540,00	500,00
										ST	560,00	520,00
77-79	B6415	38,9-40,9	36,7	36,7	43	38,9-40,9	184	30	1	TR	570,00	530,00
										ST	590,00	550,00
87-89	B6418	43,9-45,9	41,7	41,7	50	43,9-45,9	202	33	1	TR	600,00	560,00
										ST	620,00	580,00
67-69/87-89	B6472	33,9-35,9	31,7	41,7	43	43,9-45,9	197	31	1	TR	600,00	540,00
										ST	620,00	560,00
67-69/97-99	B6478	33,9-35,9	31,7	46,7	46,5	48,9-50,9	202	33	1	TR	640,00	560,00
										ST	660,00	580,00
67-69/117-119	B6479	33,9-35,9	31,7	56,7	53,5	58,9-60,9	223	37	1	TR	670,00	590,00
										ST	690,00	610,00
77-79/97-99	B6476	38,9-40,9	36,7	46,7	50	48,9-50,9	206	34	1	TR	620,00	550,00
										ST	640,00	570,00
77-79/117-119	B6477	38,9-40,9	36,7	56,7	57	58,9-60,9	206	34	1	TR	690,00	600,00
										ST	710,00	620,00

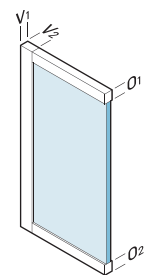

L	
V <sub>1</sub>	15mm
V <sub>2</sub>	31mm
O <sub>1</sub>	40mm
O <sub>2</sub>	40mm

DISPONIBILITA' A MAGAZZINO / STOCK AVAILABILITY

1/2 Settimane/Weeks

2/3 Settimane/Weeks

3/4 Settimane/Weeks

# AMERICA QUATTRO

PORTA SCORREVOLE  
SLIDING DOORS



Per istruzioni di montaggio  
e ricambi inquadra il codice QR  
For assembly instructions  
and spare parts, scan the QR code



H. 190cm  
SP. 4mm

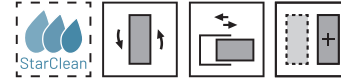

Parete doccia a due ante con apertura laterale scorrevole. Modello adatto per la maggior parte delle installazioni e disponibile in un'ampia gamma di dimensioni.

Shower wall with two panels and side sliding opening. Suitable for most installations and available in a wide range of sizes.

CONFIGURAZIONE IN NICCHIA  
NICHE CONFIGURATION

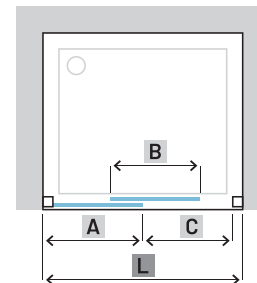

CONFIGURAZIONE AD ANGOLO  
CORNER CONFIGURATION

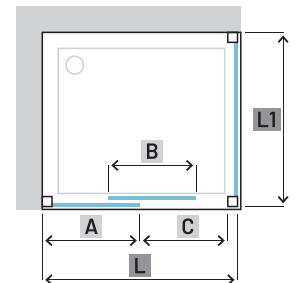

CONFIGURAZIONE A TRE LATI  
THREE-SIDED CONFIGURATION

Per le configurazioni a tre lati considerare la parete fissa (L1).  
For three-sided configurations, consider the fixed panel (L1).

## ORIENTAMENTO E POSSIBILI COMBINAZIONI / ORIENTATION AND POSSIBLE CONFIGURATIONS

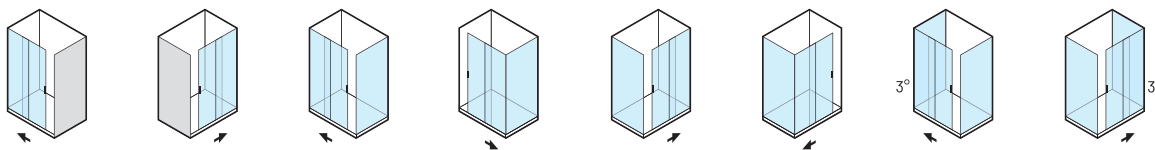

### PROFILI / PROFILES

STANDARD	
ULU	Brillantato Lucido Brilliant Polished
L91	Bianco Opaco Matte White
L96	Nero Opaco Matte Black

### VETRO / GLASS

STANDARD	
TR	Trasparente Transparent
ST	Stampato Printed
AS	Satinato Satin

## PORTA / DOOR

L [cm]	COD.	A [cm]	B [cm]	C [cm]	[dm <sup>3</sup> ]	[kg]	[Pcs]	V	ULU	L91	L96
96-103	B6440	47,1-51,1	44,9	38,5	121	24	1	TR	595,00	495,00	
								ST	625,00	520,00	
								AS	655,00	545,00	
106-113	B6442	52,1-56,1	49,9	43,5	126	25	1	TR	595,00	495,00	
								ST	625,00	520,00	
								AS	655,00	545,00	
116-123	B6444	57,1-61,1	54,9	48,5	132	26	1	TR	625,00	520,00	
								ST	655,00	545,00	
								AS	690,00	570,00	
126-133	B6446	62,1-66,1	59,9	53,5	137	27	1	TR	660,00	550,00	
								ST	695,00	580,00	
								AS	725,00	605,00	
136-143	B6448	67,1-71,1	64,9	58,5	143	28	1	TR	690,00	575,00	
								ST	725,00	605,00	
								AS	760,00	635,00	
146-153	B6450	72,1-76,1	69,9	63,5	149	29	1	TR	730,00	610,00	
								ST	765,00	640,00	
								AS	805,00	670,00	
156-163	B6452	77,1-81,1	74,9	68,5	155	30	1	TR	765,00	640,00	
								ST	805,00	670,00	
								AS	840,00	705,00	
166-173	B6454	82,1-86,1	79,9	73,5	161	31	1	TR	805,00	670,00	
								ST	845,00	705,00	
								AS	885,00	735,00	

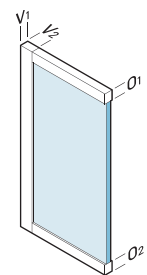

L	
V <sub>1</sub>	21mm
V <sub>2</sub>	50mm
O <sub>1</sub>	45mm
O <sub>2</sub>	45mm

## PARETE FISSA / FIXED PANEL

H. 190cm  
SP. 4mm

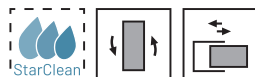

L1 [cm]	COD.	A [cm]	B [cm]	C [cm]	[dm <sup>3</sup> ]	[kg]	[Pcs]	V	ULU	L91	L96
63-67	B6421	-	-	-	118	15	1	TR	340,00	285,00	
								ST	355,00	300,00	
								AS	375,00	315,00	
67-71	B6422	-	-	-	121	16	1	TR	340,00	285,00	
								ST	355,00	300,00	
								AS	375,00	315,00	
73-77	B6424	-	-	-	123	17	1	TR	340,00	285,00	
								ST	355,00	300,00	
								AS	375,00	315,00	
77-81	B6425	-	-	-	126	18	1	TR	360,00	300,00	
								ST	380,00	315,00	
								AS	395,00	330,00	
83-87	B6427	-	-	-	130	19	1	TR	360,00	300,00	
								ST	380,00	315,00	
								AS	395,00	330,00	
87-91	B6428	-	-	-	132	20	1	TR	380,00	315,00	
								ST	400,00	330,00	
								AS	420,00	345,00	
97-101	B6429	-	-	-	135	21	1	TR	380,00	315,00	
								ST	400,00	330,00	
								AS	420,00	345,00	

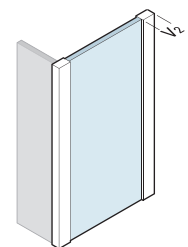

L1	
V <sub>2</sub>	55mm

SU MISURA/CUSTOM	PORTA DOOR	[€]	PARETE FISSA FIXED PANEL	[€]
▲▼ Altezza/Height <sup>1</sup>	50-200cm	+20%	50-200cm	+20%
◀▶ Larghezza/Width <sup>2</sup>	80-180cm	+20%	17-120cm	+20%
◆ Altezza/Height Larghezza/Width <sup>2</sup>	50-200cm 80-180cm	+20%	50-200cm 17-120cm	+20%
Altre forme Other shapes <sup>2</sup>		+30%		+30%

OPTIONAL	COD.	[€]	
Profilo compensazione Compensation Profile	COM7A (+4cm)	ULU L91-L96	90,00 90,00
	Porta/Door	50,00	
	Parete Fissa/Fixed Panel	50,00	

<sup>1</sup> Dal prezzo della misura di riferimento/From the price of selected size

<sup>2</sup> Dal prezzo della misura superiore/From the price of the larger size

DISPONIBILITA' A MAGAZZINO / STOCK AVAILABILITY

1/2 Settimane/Weeks

+1 StarClean Optional

2/3 Settimane/Weeks

3/4 Settimane/Weeks

# AMERICA QUATTRO

PORTA SCORREVOLE A TRE ANTE  
THREE PANELS DOOR



Per istruzioni di montaggio  
e ricambi inquadra il codice QR  
For assembly instructions  
and spare parts, scan the QR code



H. 190cm  
SP. 4mm

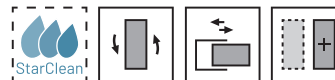

Parete doccia a 3 ante con apertura laterale scorrevoli sovrapponibili.  
Modello adatto per la maggior parte delle installazioni e disponibile in  
un'ampia gamma di dimensioni.

3-panel shower wall with side sliding overlapping doors. A model suitable  
for most installations and available in a wide range of sizes.

CONFIGURAZIONE IN NICCHIA  
NICHE CONFIGURATION

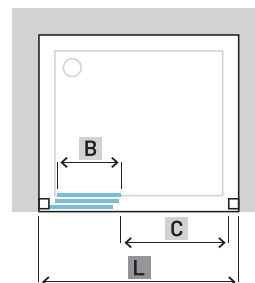

CONFIGURAZIONE AD ANGOLO  
CORNER CONFIGURATION

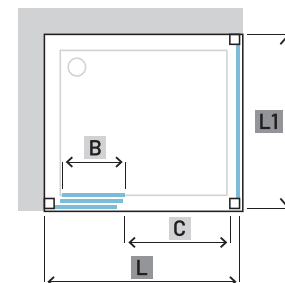

CONFIGURAZIONE A TRE LATI  
THREE-SIDED CONFIGURATION

Per le configurazioni a tre lati considerare la parete fissa (L1).  
For three-sided configurations, consider the fixed panel (L1).

## ORIENTAMENTO E POSSIBILI COMBINAZIONI / ORIENTATION AND POSSIBLE CONFIGURATIONS

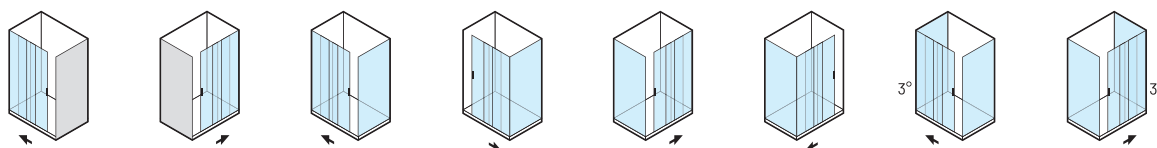

### PROFILI / PROFILES

STANDARD	
ULU	Brillantato Lucido Brilliant Polished
L91	Bianco Opaco Matte White
L96	Nero Opaco Matte Black

### VETRO / GLASS

STANDARD	
TR	Trasparente Transparent
ST	Stampato Printed
AS	Satinato Satin

## PORTA / DOOR

L [cm]	COD.	A [cm]	B [cm]	C [cm]	[dm <sup>3</sup> ]	[kg]	[Pcs]	V	ULU	L91	L96
68-76	B6408	-	21,2	32	132	19	1	TR	555,00	465,00	
								ST	585,00	490,00	
								AS	610,00	510,00	
77-85	B6409	-	24,2	38	137	21	1	TR	580,00	485,00	
								ST	610,00	510,00	
								AS	640,00	535,00	
86-94	B6410	-	27,2	44	143	23	1	TR	605,00	505,00	
								ST	635,00	530,00	
								AS	665,00	555,00	
95-103	B6411	-	30,2	50	149	25	1	TR	630,00	525,00	
								ST	660,00	550,00	
								AS	695,00	580,00	
104-112	B6455	-	33,2	56	153	26	1	TR	655,00	545,00	
								ST	690,00	570,00	
								AS	720,00	600,00	
113-121	B6456	-	36,2	62	159	29	1	TR	685,00	570,00	
								ST	720,00	600,00	
								AS	755,00	625,00	

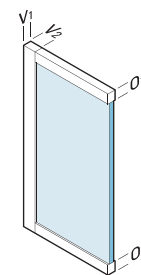

L	
V <sub>1</sub>	21mm
V <sub>2</sub>	50mm
O <sub>1</sub>	45mm
O <sub>2</sub>	45mm

## PARETE FISSA / FIXED PANEL

H. 190cm  
SP. 4mm

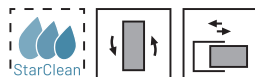

L1 [cm]	COD.	A [cm]	B [cm]	C [cm]	[dm <sup>3</sup> ]	[kg]	[Pcs]	V	ULU	L91	L96
63-67	B6421	-	-	-	118	15	1	TR	340,00	285,00	
								ST	355,00	300,00	
								AS	375,00	315,00	
67-71	B6422	-	-	-	121	16	1	TR	340,00	285,00	
								ST	355,00	300,00	
								AS	375,00	315,00	
73-77	B6424	-	-	-	123	17	1	TR	340,00	285,00	
								ST	355,00	300,00	
								AS	375,00	315,00	
77-81	B6425	-	-	-	126	18	1	TR	360,00	300,00	
								ST	380,00	315,00	
								AS	395,00	330,00	
83-87	B6427	-	-	-	130	19	1	TR	360,00	300,00	
								ST	380,00	315,00	
								AS	395,00	330,00	
87-91	B6428	-	-	-	132	20	1	TR	380,00	315,00	
								ST	400,00	330,00	
								AS	420,00	345,00	
97-101	B6429	-	-	-	135	21	1	TR	380,00	315,00	
								ST	400,00	330,00	
								AS	420,00	345,00	

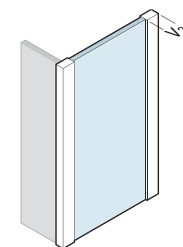

L1	
V <sub>2</sub>	55mm

SU MISURA/CUSTOM	PORTA DOOR	[€]	PARETE FISSA FIXED PANEL	[€]
▲▼ Altezza/Height <sup>1</sup>	50-200cm	+20%	50-200cm	+20%
◀▶ Larghezza/Width <sup>2</sup>	60-170cm	+20%	17-120cm	+20%
◆ Altezza/Height Larghezza/Width <sup>2</sup>	50-200cm 60-170cm	+20%	50-200cm 17-120cm	+20%
Altre forme Other shapes <sup>2</sup>		+30%		+30%

OPTIONAL	COD.	[€]
Profilo compensazione Compensation Profile	COM7A ULU (+4cm) L91-L96	90,00 90,00
	Porta/Door	100,00
	Parete Fissa/Fixed Panel	50,00

<sup>1</sup> Dal prezzo della misura di riferimento/From the price of selected size

<sup>2</sup> Dal prezzo della misura superiore/From the price of the larger size

DISPONIBILITÀ A MAGAZZINO / STOCK AVAILABILITY

1/2 Settimane/Weeks

2/3 Settimane/Weeks

3/4 Settimane/Weeks

+1 StarClean Optional

# AMERICA QUATTRO

PORTA BATTENTE  
HINGED DOOR



Per istruzioni di montaggio  
e ricambi inquadra il codice QR  
For assembly instructions  
and spare parts, scan the QR code



H. 190cm  
SP. 4mm

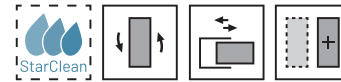

Parete doccia con apertura a porta battente. L'apertura dell'anta è sia verso l'interno che verso l'esterno. Modello adatto per situazioni che necessitano della massima apertura possibile.

Shower enclosure with a hinged door. The door opens both inward and outward. A model suitable for situations requiring the maximum possible opening.

CONFIGURAZIONE IN NICCHIA  
NICHE CONFIGURATION

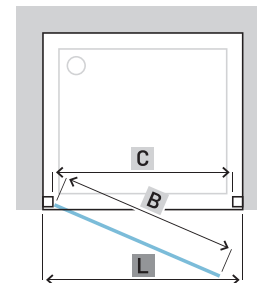

CONFIGURAZIONE AD ANGOLO  
CORNER CONFIGURATION

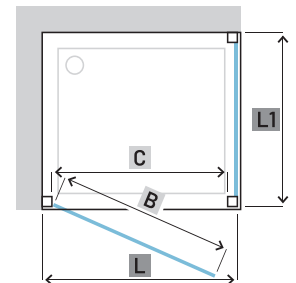

CONFIGURAZIONI A TRE LATI  
THREE-SIDED CONFIGURATIONS

Non è possibile realizzare configurazioni a tre lati.  
It is not possible to create three-sided configurations.

## ORIENTAMENTO E POSSIBILI COMBINAZIONI / ORIENTATION AND POSSIBLE CONFIGURATIONS

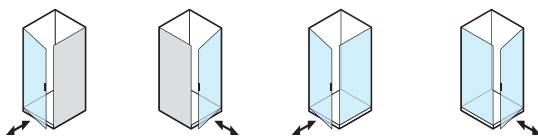

### PROFILI / PROFILES

STANDARD	
ULU	Brillantato Lucido Brilliant Polished
L91	Bianco Opaco Matte White
L96	Nero Opaco Matte Black

### VETRO / GLASS

STANDARD	
TR	Trasparente Transparent
ST	Stampato Printed
AS	Satinato Satin

## PORTA / DOOR

L [cm]	COD.	A [cm]	B [cm]	C [cm]	[dm <sup>3</sup> ]	[kg]	[Pcs]	V	ULU	L91	L96
66-74	B6401	-	51,8	52	117	16	1	TR	495,00	415,00	
								ST	520,00	435,00	
								AS	545,00	455,00	
76-84	B6403	-	61,8	62	131	18	1	TR	515,00	430,00	
								ST	540,00	450,00	
								AS	565,00	475,00	
86-94	B6405	-	71,8	72	148	19	1	TR	545,00	455,00	
								ST	570,00	480,00	
								AS	600,00	500,00	
96-104	B6407	-	81,8	82	155	20	1	TR	545,00	455,00	
								ST	570,00	480,00	
								AS	600,00	500,00	

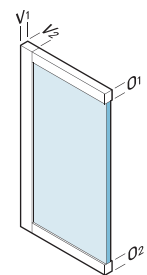

L	
V <sub>1</sub>	21mm
V <sub>2</sub>	50mm
O <sub>1</sub>	45mm
O <sub>2</sub>	45mm

## PARETE FISSA / FIXED PANEL

H. 190cm  
SP. 4mm

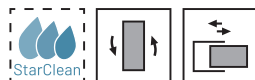

L1 [cm]	COD.	A [cm]	B [cm]	C [cm]	[dm <sup>3</sup> ]	[kg]	[Pcs]	V	ULU	L91	L96
63-67	B6421	-	-	-	118	15	1	TR	340,00	285,00	
								ST	355,00	300,00	
								AS	375,00	315,00	
67-71	B6422	-	-	-	121	16	1	TR	340,00	285,00	
								ST	355,00	300,00	
								AS	375,00	315,00	
73-77	B6424	-	-	-	123	17	1	TR	340,00	285,00	
								ST	355,00	300,00	
								AS	375,00	315,00	
77-81	B6425	-	-	-	126	18	1	TR	360,00	300,00	
								ST	380,00	315,00	
								AS	395,00	330,00	
83-87	B6427	-	-	-	130	19	1	TR	360,00	300,00	
								ST	380,00	315,00	
								AS	395,00	330,00	
87-91	B6428	-	-	-	132	20	1	TR	380,00	315,00	
								ST	400,00	330,00	
								AS	420,00	345,00	
97-101	B6429	-	-	-	135	21	1	TR	380,00	315,00	
								ST	400,00	330,00	
								AS	420,00	345,00	

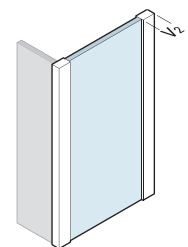

L1	
V <sub>2</sub>	55mm

SU MISURA/CUSTOM	PORTA DOOR	[€]	PARETE FISSA FIXED PANEL	[€]
▲▼ Altezza/Height <sup>1</sup>	50-200cm	+20%	50-200cm	+20%
◀▶ Larghezza/Width <sup>2</sup>	50-100cm	+20%	17-120cm	+20%
◆ Altezza/Height Larghezza/Width <sup>2</sup>	50-200cm 50-100cm	+20%	50-200cm 17-120cm	+20%
Altre forme Other shapes <sup>2</sup>		+30%		+30%

OPTIONAL	COD.	[€]
Profilo compensazione Compensation Profile	COM7A ULU (+4cm) L91-L96	90,00 90,00
StarClean	Porta/Door Parete Fissa/Fixed Panel	50,00 50,00

<sup>1</sup> Dal prezzo della misura di riferimento/From the price of selected size

<sup>2</sup> Dal prezzo della misura superiore/From the price of the larger size

DISPONIBILITÀ A MAGAZZINO / STOCK AVAILABILITY

1/2 Settimane/Weeks  
+1 StarClean Optional

2/3 Settimane/Weeks

3/4 Settimane/Weeks

# AMERICA QUATTRO

PORTA SALOON  
SALOON DOOR



Per istruzioni di montaggio  
e ricambi inquadra il codice QR  
For assembly instructions  
and spare parts, scan the QR code



H. 190cm  
SP. 4mm



Parete doccia con due ante con apertura a saloon. L'apertura delle ante è sia verso l'interno che verso l'esterno. Modello adatto per situazioni che necessitano di un ingresso ampio, ma con spazio di installazione limitato.

Shower enclosure with two saloon-style doors. The doors open both inward and outward. A model suitable for situations requiring a wide entry but with limited installation space.

CONFIGURAZIONE IN NICCHIA  
NICHE CONFIGURATION

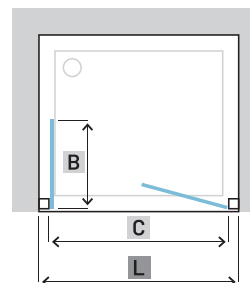

CONFIGURAZIONE AD ANGOLO  
CORNER CONFIGURATION

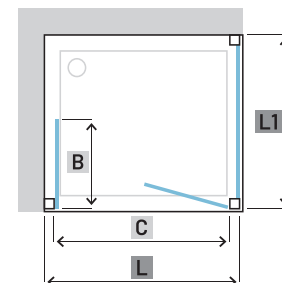

CONFIGURAZIONE A TRE LATI  
THREE-SIDED CONFIGURATION

Per le configurazioni a tre lati considerare la parete fissa (L1).  
For three-sided configurations, consider the fixed panel (L1).

## ORIENTAMENTO E POSSIBILI COMBINAZIONI / ORIENTATION AND POSSIBLE CONFIGURATIONS

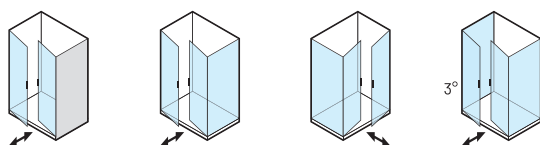

### PROFILI / PROFILES

STANDARD	
ULU	Brillantato Lucido Brilliant Polished
L91	Bianco Opaco Matte White
L96	Nero Opaco Matte Black

### VETRO / GLASS

STANDARD	
TR	Trasparente Transparent
ST	Stampato Printed
AS	Satinato Satin

## PORTA / DOOR

L [cm]	COD.	A [cm]	B [cm]	C [cm]	[dm <sup>3</sup> ]	[kg]	[Pcs]	V	ULU	L91	L96
66-74	B6431	-	25	49,5	117	16	1	TR	570,00	475,00	
								ST	600,00	500,00	
								AS	625,00	525,00	
76-84	B6433	-	30	59,5	131	18	1	TR	600,00	500,00	
								ST	630,00	525,00	
								AS	660,00	550,00	
86-94	B6435	-	35	69,5	148	19	1	TR	625,00	520,00	
								ST	655,00	545,00	
								AS	690,00	570,00	
96-104	B6437	-	40	79,5	155	20	1	TR	645,00	540,00	
								ST	675,00	565,00	
								AS	710,00	595,00	

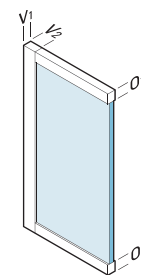

L	
V <sub>1</sub>	21mm
V <sub>2</sub>	50mm
O <sub>1</sub>	45mm
O <sub>2</sub>	45mm

## PARETE FISSA / FIXED PANEL

H. 190cm  
SP. 4mm

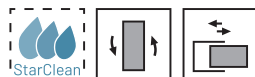

L1 [cm]	COD.	A [cm]	B [cm]	C [cm]	[dm <sup>3</sup> ]	[kg]	[Pcs]	V	ULU	L91	L96
63-67	B6421	-	-	-	118	15	1	TR	340,00	285,00	
								ST	355,00	300,00	
								AS	375,00	315,00	
67-71	B6422	-	-	-	121	16	1	TR	340,00	285,00	
								ST	355,00	300,00	
								AS	375,00	315,00	
73-77	B6424	-	-	-	123	17	1	TR	340,00	285,00	
								ST	355,00	300,00	
								AS	375,00	315,00	
77-81	B6425	-	-	-	126	18	1	TR	360,00	300,00	
								ST	380,00	315,00	
								AS	395,00	330,00	
83-87	B6427	-	-	-	130	19	1	TR	360,00	300,00	
								ST	380,00	315,00	
								AS	395,00	330,00	
87-91	B6428	-	-	-	132	20	1	TR	380,00	315,00	
								ST	400,00	330,00	
								AS	420,00	345,00	
97-101	B6429	-	-	-	135	21	1	TR	380,00	315,00	
								ST	400,00	330,00	
								AS	420,00	345,00	

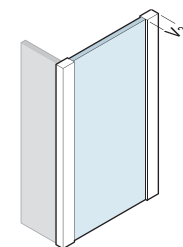

L1	
V <sub>2</sub>	55mm

SU MISURA/CUSTOM	PORTA DOOR	[€]	PARETE FISSA FIXED PANEL	[€]
▲▼ Altezza/Height <sup>1</sup>	50-200cm	+20%	50-200cm	+20%
◀▶ Larghezza/Width <sup>2</sup>	50-120cm	+20%	17-120cm	+20%
◆ Altezza/Height Larghezza/Width <sup>2</sup>	50-200cm 50-120cm	+20%	50-200cm 17-120cm	+20%
Altre forme Other shapes <sup>2</sup>		+30%		+30%

OPTIONAL	COD.	[€]
Profilo compensazione Compensation Profile	COM7A ULU (+4cm) L91-L96	90,00 90,00
StarClean	Porta/Door Parete Fissa/Fixed Panel	50,00 50,00

<sup>1</sup> Dal prezzo della misura di riferimento/From the price of selected size

<sup>2</sup> Dal prezzo della misura superiore/From the price of the larger size

DISPONIBILITÀ A MAGAZZINO / STOCK AVAILABILITY

1/2 Settimane/Weeks +1 StarClean Optional	2/3 Settimane/Weeks	3/4 Settimane/Weeks
--	---------------------	---------------------

# AMERICA QUATTRO

PORTA SOFFIETTO  
FOLDING DOOR



Per istruzioni di montaggio  
e ricambi inquadra il codice QR  
For assembly instructions  
and spare parts, scan the QR code



H. 190cm  
SP. 4mm

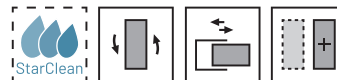

Parete doccia con due ante con apertura a soffietto. L'apertura delle ante è verso l'interno. Modello adatto per situazioni che necessitano di un ingresso ampio, ma con spazio di installazione limitato.

Shower enclosure with two folding doors. The doors open inward. This model is suitable for situations requiring a wide entrance, but with limited installation space.

CONFIGURAZIONE IN NICCHIA  
NICHE CONFIGURATION

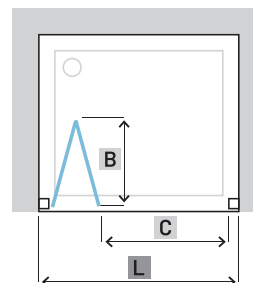

CONFIGURAZIONE AD ANGOLO  
CORNER CONFIGURATION

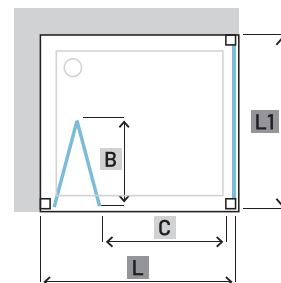

CONFIGURAZIONE A TRE LATI  
THREE-SIDED CONFIGURATION

Per le configurazioni a tre lati considerare la parete fissa (L1).  
For three-sided configurations, consider the fixed panel (L1).

## ORIENTAMENTO E POSSIBILI COMBINAZIONI / ORIENTATION AND POSSIBLE CONFIGURATIONS

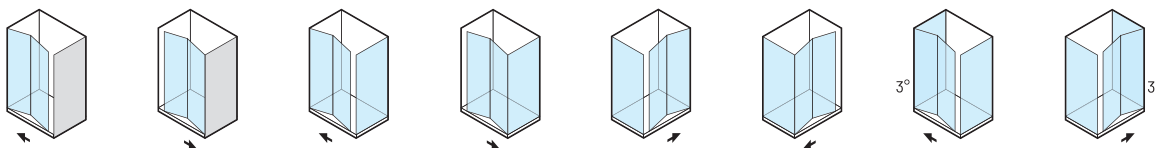

### PROFILI / PROFILES

STANDARD	
ULU	Brillantato Lucido Brilliant Polished
L91	Bianco Opaco Matte White
L96	Nero Opaco Matte Black

### VETRO / GLASS

STANDARD	
TR	Trasparente Transparent
ST	Stampato Printed
AS	Satinato Satin

## PORTA / DOOR

L [cm]	COD.	A [cm]	B [cm]	C [cm]	[dm <sup>3</sup> ]	[kg]	[Pcs]	V	ULU	L91	L96
66-74	B6461	-	28,8	36	118	16	1	TR	635,00	530,00	
								ST	665,00	555,00	
								AS	700,00	585,00	
76-84	B6463	-	34	46	122	20	1	TR	660,00	550,00	
								ST	695,00	580,00	
								AS	725,00	605,00	
86-94	B6465	-	38,7	56	128	21	1	TR	685,00	570,00	
								ST	720,00	600,00	
								AS	755,00	625,00	
96-104	B6467	-	43,6	66	137	22	1	TR	710,00	590,00	
								ST	745,00	620,00	
								AS	780,00	650,00	

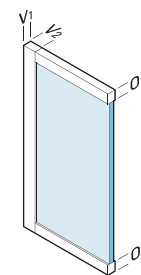

L	
V <sub>1</sub>	21mm
V <sub>2</sub>	50mm
O <sub>1</sub>	45mm
O <sub>2</sub>	45mm

## PARETE FISSA / FIXED PANEL

H. 190cm  
SP. 4mm

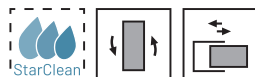

L1 [cm]	COD.	A [cm]	B [cm]	C [cm]	[dm <sup>3</sup> ]	[kg]	[Pcs]	V	ULU	L91	L96
63-67	B6421	-	-	-	118	15	1	TR	340,00	285,00	
								ST	355,00	300,00	
								AS	375,00	315,00	
67-71	B6422	-	-	-	121	16	1	TR	340,00	285,00	
								ST	355,00	300,00	
								AS	375,00	315,00	
73-77	B6424	-	-	-	123	17	1	TR	340,00	285,00	
								ST	355,00	300,00	
								AS	375,00	315,00	
77-81	B6425	-	-	-	126	18	1	TR	360,00	300,00	
								ST	380,00	315,00	
								AS	395,00	330,00	
83-87	B6427	-	-	-	130	19	1	TR	360,00	300,00	
								ST	380,00	315,00	
								AS	395,00	330,00	
87-91	B6428	-	-	-	132	20	1	TR	380,00	315,00	
								ST	400,00	330,00	
								AS	420,00	345,00	
97-101	B6429	-	-	-	135	21	1	TR	380,00	315,00	
								ST	400,00	330,00	
								AS	420,00	345,00	

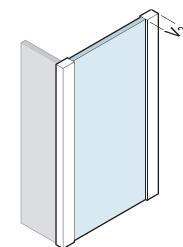

L1	
V <sub>2</sub>	55mm

SU MISURA/CUSTOM	PORTA DOOR	[€]	PARETE FISSA FIXED PANEL	[€]
▲▼ Altezza/Height <sup>1</sup>	50-200cm	+20%	50-200cm	+20%
◀▶ Larghezza/Width <sup>2</sup>	50-120cm	+20%	17-120cm	+20%
◆ Altezza/Height Larghezza/Width <sup>2</sup>	50-200cm 50-120cm	+20%	50-200cm 17-120cm	+20%
Altre forme Other shapes <sup>2</sup>		+30%		+30%

OPTIONAL	COD.	[€]
Profilo compensazione Compensation Profile	COM7A ULU (+4cm) L91-L96	90,00 90,00
	Porta/Door	50,00
	Parete Fissa/Fixed Panel	50,00

<sup>1</sup> Dal prezzo della misura di riferimento/From the price of selected size

<sup>2</sup> Dal prezzo della misura superiore/From the price of the larger size

DISPONIBILITA' A MAGAZZINO / STOCK AVAILABILITY

1/2 Settimane/Weeks +1 StarClean Optional	2/3 Settimane/Weeks	3/4 Settimane/Weeks
--	---------------------	---------------------

# AMERICA QUATTRO

STONDATO DOPPIA PORTA SCORREVOLE  
ROUNDED DOUBLE SLIDING DOOR



Per istruzioni di montaggio  
e ricambi inquadra il codice QR  
For assembly instructions  
and spare parts, scan the QR code



H. 190cm  
SP. 4mm

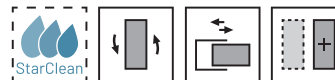

Parete doccia stondata disponibile in versioni per installazioni in angolo in dimensioni quadrate. Il modello dispone di quattro ante di cui le due centrali apribili.

Curved shower enclosure available in versions for corner installations in square sizes. The model features four panels, with the two central ones being openable.

## CONFIGURAZIONE AD ANGOLO CORNER CONFIGURATION

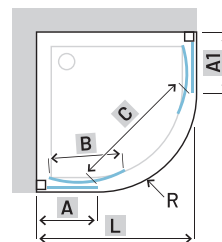

B6470 R 38cm  
B6473 R 55cm  
B6471 R 55cm

## CONFIGURAZIONE A TRE LATI THREE-SIDED CONFIGURATION

Per le configurazioni a tre lati considerare la parete fissa (L1).  
For three-sided configurations, consider the fixed panel (L1).

## ORIENTAMENTO E POSSIBILI COMBINAZIONI / ORIENTATION AND POSSIBLE CONFIGURATIONS

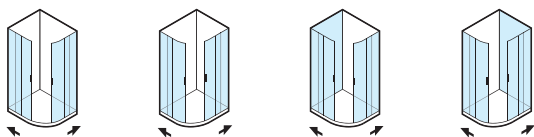

### PROFILI / PROFILES

STANDARD	
ULU	Brillantato Lucido Brilliant Polished
L91	Bianco Opaco Matte White
L96	Nero Opaco Matte Black

### VETRO / GLASS

STANDARD	
TR	Trasparente Transparent
ST	Stampato Printed
AS	Satinato Satin

## PORTA / DOOR

L [cm]	COD.	A [cm]	B [cm]	C [cm]	[dm <sup>3</sup> ]	[kg]	[Pcs]	V	ULU	L91	L96
71,5-75,5	B6470	33,9-37,9	28,3	41	42-44	31	1	TR	1.000,00	835,00	
								ST	1.050,00	875,00	
								AS	1.100,00	920,00	
76-80	B6473	21,5-25,5	41,3	36	43-45	33	1	TR	1.015,00	845,00	
								ST	1.065,00	885,00	
								AS	1.115,00	930,00	
86-90	B6471	31,5-35,5	41,3	51,5	48-50	37	1	TR	1.045,00	870,00	
								ST	1.095,00	915,00	
								AS	1.150,00	955,00	

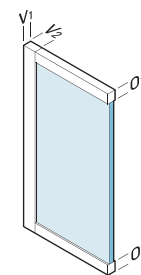

L	
V <sub>1</sub>	21mm
V <sub>2</sub>	50mm
O <sub>1</sub>	45mm
O <sub>2</sub>	45mm

## PARETE FISSA / FIXED PANEL

H. 190cm  
SP. 4mm

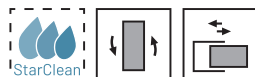

L1 [cm]	COD.	A [cm]	B [cm]	C [cm]	[dm <sup>3</sup> ]	[kg]	[Pcs]	V	ULU	L91	L96
63-67	B6421	-	-	-	118	15	1	TR	340,00	285,00	
								ST	355,00	300,00	
								AS	375,00	315,00	
67-71	B6422	-	-	-	121	16	1	TR	340,00	285,00	
								ST	355,00	300,00	
								AS	375,00	315,00	
73-77	B6424	-	-	-	123	17	1	TR	340,00	285,00	
								ST	355,00	300,00	
								AS	375,00	315,00	
77-81	B6425	-	-	-	126	18	1	TR	360,00	300,00	
								ST	380,00	315,00	
								AS	395,00	330,00	
83-87	B6427	-	-	-	130	19	1	TR	360,00	300,00	
								ST	380,00	315,00	
								AS	395,00	330,00	
87-91	B6428	-	-	-	132	20	1	TR	380,00	315,00	
								ST	400,00	330,00	
								AS	420,00	345,00	
97-101	B6429	-	-	-	135	21	1	TR	380,00	315,00	
								ST	400,00	330,00	
								AS	420,00	345,00	

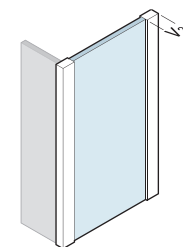

L1	
V <sub>2</sub>	55mm

SU MISURA/CUSTOM	PORTA DOOR	[€]	PARETE FISSA FIXED PANEL	[€]
Altezza/Height <sup>1</sup>	Vedi nota/See note <sup>3</sup>	-	50-200cm	+20%
Larghezza/Width <sup>2</sup>	Vedi nota/See note <sup>3</sup>	+20%	17-120cm	+20%
Altezza/Height Larghezza/Width <sup>2</sup>	Vedi nota/See note <sup>3</sup>	-	50-200cm 17-120cm	+20%
Altre forme Other shapes <sup>2</sup>		+30%		+30%

OPTIONAL	COD.	[€]
Profilo compensazione Compensation Profile	COM7A ULU (+4cm) L91-L96	90,00 90,00
	Porta/Door	100,00
	Parete Fissa/Fixed Panel	50,00

<sup>1</sup> Dal prezzo della misura di riferimento/From the price of selected size

<sup>2</sup> Dal prezzo della misura superiore/From the price of the larger size

<sup>3</sup> Contattare l'ufficio clienti per informazioni / Contact the customer service office for information

DISPONIBILITA' A MAGAZZINO / STOCK AVAILABILITY

1/2 Settimane/Weeks

2/3 Settimane/Weeks

3/4 Settimane/Weeks

+1 StarClean Optional

# AMERICA QUATTRO

PARETE FISSA  
FIXED PANEL



Per istruzioni di montaggio  
e ricambi inquadra il codice QR  
For assembly instructions  
and spare parts, scan the QR code



H. 190cm  
SP. 4mm

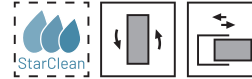

Parete fissa per abbinamenti. È possibile utilizzarla in abbinamento al modello di parete doccia selezionato per realizzare installazioni ad angolo o a tre lati quando possibile.

*Fixed panel for combinations. It can be used in combination with the selected shower enclosure model to create corner or three-sided installations where possible.*

## CONFIGURAZIONI IN ANGOLO ED A TRE LATI CORNER AND THREE-SIDED CONFIGURATIONS

È possibile realizzare configurazioni ad angolo ed a tre lati. Verificare le possibilità nelle pagine dei modelli specifici.

*It is possible to create corner and three-sided configurations; Check the options on the pages of the specific models.*

## ORIENTAMENTO E POSSIBILI COMBINAZIONI / ORIENTATION AND POSSIBLE CONFIGURATIONS

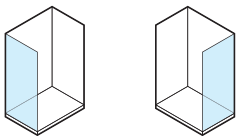

### PROFILI / PROFILES

STANDARD	
ULU	Brillantato Lucido Brilliant Polished
L91	Bianco Opaco Matte White
L96	Nero Opaco Matte Black

### VETRO / GLASS

STANDARD	
TR	Trasparente Transparent
ST	Stampato Printed
AS	Satinato Satin

**PORTA / DOOR**

L1 [cm]	COD.	A [cm]	B [cm]	C [cm]	[dm <sup>3</sup> ]	[kg]	[Pcs]	V	ULU	L91	L96
63-67	B6421	-	-	-	118	15	1	TR	340,00	285,00	
								ST	355,00	300,00	
								AS	375,00	315,00	
67-71	B6422	-	-	-	121	16	1	TR	340,00	285,00	
								ST	355,00	300,00	
								AS	375,00	315,00	
73-77	B6424	-	-	-	123	17	1	TR	340,00	285,00	
								ST	355,00	300,00	
								AS	375,00	315,00	
77-81	B6425	-	-	-	126	18	1	TR	360,00	300,00	
								ST	380,00	315,00	
								AS	395,00	330,00	
83-87	B6427	-	-	-	130	19	1	TR	360,00	300,00	
								ST	380,00	315,00	
								AS	395,00	330,00	
87-91	B6428	-	-	-	132	20	1	TR	380,00	315,00	
								ST	400,00	330,00	
								AS	420,00	345,00	
97-101	B6429	-	-	-	135	21	1	TR	380,00	315,00	
								ST	400,00	330,00	
								AS	420,00	345,00	

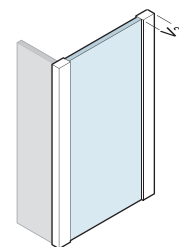

L1  
V<sub>2</sub> 55mm

SU MISURA/CUSTOM	PORTA DOOR	[€]
↕ Altezza/Height <sup>1</sup>	50-200cm	+20%
↔ Larghezza/Width <sup>2</sup>	17-120cm	+20%
↕ Altezza/Height ↔ Larghezza/Width <sup>2</sup>	50-200cm 17-120cm	+20%
Altre forme Other shapes <sup>2</sup>		+30%

OPTIONAL	COD.	[€]
Profilo compensazione Compensation Profile	COM7A ULU (+4cm) L91-L96	90,00 90,00
StarClean	Parete Fissa/Fixed Panel	50,00

<sup>1</sup> Dal prezzo della misura di riferimento/From the price of selected size

<sup>2</sup> Dal prezzo della misura superiore/From the price of the larger size

**DISPONIBILITA' A MAGAZZINO / STOCK AVAILABILITY**

1/2 Settimane/Weeks  
+1 StarClean Optional

2/3 Settimane/Weeks

3/4 Settimane/Weeks

# AMERICA QUATTRO SP





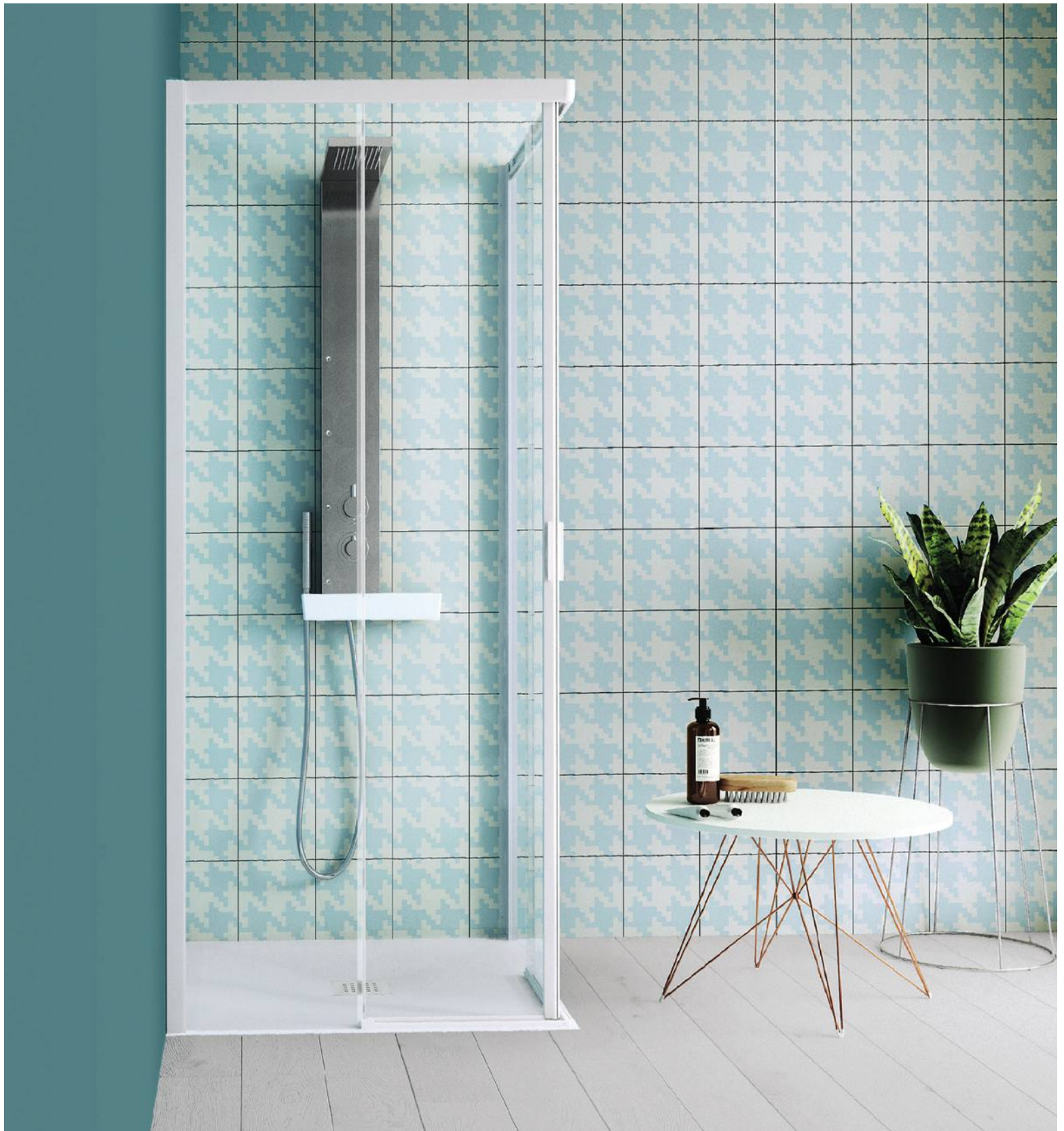

- > Parete doccia con telaio parziale
- > Vetro temperato 4mm per tutta la gamma
- > Trattamento anticalcare StarClean disponibile su richiesta
- > Estensibilità e regolazione fuori squadra del muro fino a 4cm
- > Maniglia e componentistica in finitura con il telaio
- > Profilo orizzontale inferiore assente per una maggiore ricercatezza estetica
- > Sgancio anta scorrevole per una agile pulizia del prodotto
- > Profilo magnetico di chiusura in alluminio

- > Shower enclosure with partial frame
- > 4mm tempered glass across the entire range
- > StarClean anti-limescale treatment available upon request
- > Adjustability and wall misalignment correction up to 4cm
- > Handle and components matching the frame finish
- > No lower horizontal profile for a more refined aesthetic
- > Sliding door release for easy cleaning available on full sliding corner doors
- > Magnetic aluminum closing profile

# AMERICA QUATTRO SP

## PRODOTTI DELLA SERIE / PRODUCTS OF THE SERIES

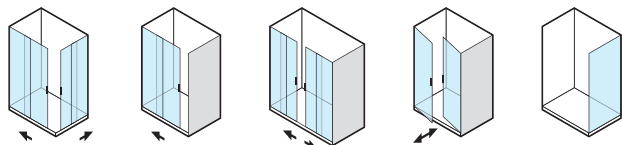

312-313  
314-315

316-317

318-319

320-321

322-323

## PROFILI / PROFILES

### STANDARD

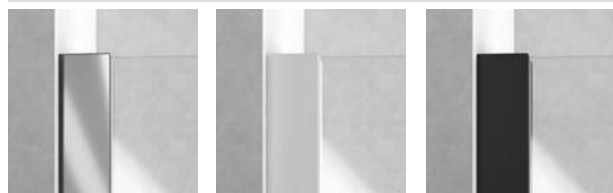

**ULU**

Brillantato Lucido  
Brilliant Polished

**L91**

Bianco Opaco  
Matte White

**L96**

Nero Opaco  
Matte Black

## VETRO / GLASS

### STANDARD



**TR**

Trasparente  
Transparent

**RF**

Fascia H.100cm  
Band H.100cm

# AMERICA QUATTRO SP

LATO ANGOLO  
SIDE CORNER



Per istruzioni di montaggio  
e ricambi inquadra il codice QR  
For assembly instructions  
and spare parts, scan the QR code



H. 190cm  
SP. 4mm

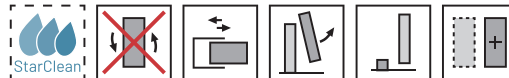

Parete doccia ad angolo a quattro ante, apertura ad ante scorrevoli nell'angolo del prodotto. Modello adatto per la maggior parte delle installazioni e disponibile in un'ampia gamma di dimensioni, soprattutto per chi vuole massimizzare le dimensioni d'ingresso.

Corner shower wall with four panels, featuring sliding doors at the corner of the product. Suitable for most installations and available in a wide range of sizes, especially for those looking to maximize the entry dimensions.

## CONFIGURAZIONE AD ANGOLO CORNER CONFIGURATION

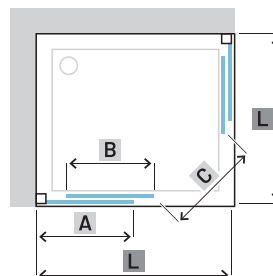

## CONFIGURAZIONE A TRE LATI THREE-SIDED CONFIGURATION

Per le configurazioni a tre lati considerare due volte la parete fissa (L1) specificando correttamente l'orientamento (destra o sinistra).  
For three-sided configurations, consider the fixed panel (L1) twice, specifying the correct orientation (right or left).

## ORIENTAMENTO E POSSIBILI COMBINAZIONI / ORIENTATION AND POSSIBLE CONFIGURATIONS

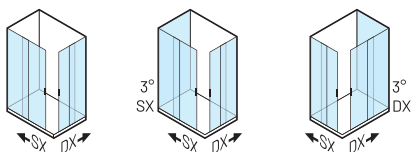

### PROFILI / PROFILES

STANDARD	
ULU	Brillantato Lucido Brilliant Polished
L91	Bianco Opaco Matte White
L96	Nero Opaco Matte Black

### VETRO / GLASS

STANDARD	
TR	Trasparente Transparent
RF	Fascia H.100cm Band H.100cm

## PORTA / DOOR

L [cm]	COD.	A [cm]	B [cm]	C [cm]	[dm <sup>3</sup> ]	[kg]	[Pcs]	V	ULU	L91	L96
67-69	B6382	32-34	32,5	36	118	19	1	TR	375,00	375,00	
								RF	470,00	470,00	
69-71	B6383	33-35	33,5	37	122	20	1	TR	375,00	375,00	
								RF	470,00	470,00	
73-75	B6384	35-37	35,5	40	128	21	1	TR	385,00	385,00	
								RF	480,00	480,00	
77-79	B6385	37-39	37,5	43	137	22	1	TR	395,00	395,00	
								RF	495,00	495,00	
79-81	B6386	38-40	38,5	44	140	23	1	TR	395,00	395,00	
								RF	495,00	495,00	
83-85	B6387	40-42	40,5	47	145	24	1	TR	405,00	405,00	
								RF	505,00	505,00	
87-89	B6388	42-44	42,5	50	151	25	1	TR	420,00	420,00	
								RF	525,00	525,00	
89-91	B6389	43-45	43,5	51	155	26	1	TR	420,00	420,00	
								RF	525,00	525,00	
93-95	B6390	45-47	45,5	54	160	27	1	TR	420,00	420,00	
								RF	525,00	525,00	
97-99	B6391	47-49	47,5	57	168	28	1	TR	430,00	430,00	
								RF	540,00	540,00	
99-101	B6392	48-50	48,5	58	173	29	1	TR	430,00	430,00	
								RF	540,00	540,00	
103-105	B6393	50-52	50,5	61	179	29	1	TR	450,00	450,00	
								RF	565,00	565,00	
107-109	B6394	54-56	50,5	61	184	30	1	TR	460,00	460,00	
								RF	575,00	575,00	
109-111	B6395	53-55	53,5	65	190	31	1	TR	460,00	460,00	
								RF	575,00	575,00	
113-115	B6396	56,5-58,5	53,5	65	195	32	1	TR	465,00	465,00	
								RF	580,00	580,00	
117-119	B6397	60,5-62,5	53,5	65	201	33	1	TR	470,00	470,00	
								RF	590,00	590,00	
119-121	B6398	62,5-64,5	53,5	65	209	34	1	TR	470,00	470,00	
								RF	590,00	590,00	

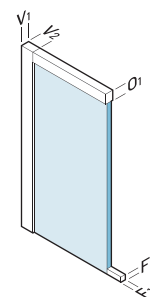

L	
V <sub>1</sub>	28mm
V <sub>2</sub>	40mm
O <sub>1</sub>	45mm
F <sub>1</sub>	10mm
F <sub>2</sub>	10mm

I valori della tabella prezzi si riferiscono ad un singolo lato; sommare l'importo dei due codici della misura desiderata per ottenere il prezzo totale di una doccia ad angolo quadrata o rettangolare. Apertura (C) determinata con due lati della stessa misura. Specificare il verso di apertura della parete doccia (/SX o /DX).

The prices in the table refer to a single side; add the amounts of the two codes for the desired size to get the total price of a square or rectangular corner shower. Opening (C) is determined by two sides of the same size. Specify the opening direction of the shower enclosure (/SX or /DX).

## PARETE FISSA / FIXED PANEL

H. 190cm  
SP. 4mm

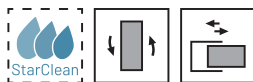

L1 [cm]	COD.	A [cm]	B [cm]	C [cm]	[dm <sup>3</sup> ]	[kg]	[Pcs]	V	ULU	L91	L96
63-65	B6321	-	-	-	117	16	1	TR	360,00	360,00	
								RF	450,00	450,00	
67-69	B6322	-	-	-	131	18	1	TR	360,00	360,00	
								RF	450,00	450,00	
69-71	B6323	-	-	-	148	19	1	TR	360,00	360,00	
								RF	450,00	450,00	
73-75	B6324	-	-	-	155	20	1	TR	360,00	360,00	
								RF	450,00	450,00	
77-79	B6325	-	-	-	163	21	1	TR	385,00	385,00	
								RF	480,00	480,00	
79-81	B6326	-	-	-	170	22	1	TR	385,00	385,00	
								RF	480,00	480,00	
83-85	B6327	-	-	-	175	23	1	TR	385,00	385,00	
								RF	480,00	480,00	
87-89	B6328	-	-	-	170	22	1	TR	405,00	405,00	
								RF	505,00	505,00	
89-91	B6329	-	-	-	175	23	1	TR	405,00	405,00	
								RF	505,00	505,00	

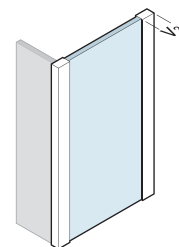

L1	
V <sub>2</sub>	45mm

SU MISURA/CUSTOM	PORTA DOOR	[€]	PARETE FISSA FIXED PANEL	[€]
Altezza/Height <sup>1</sup>	120-200cm	+20%	100-200cm	+20%
Larghezza/Width <sup>2</sup>	50-130cm	+20%	15-120cm	+20%
Altezza/Height Larghezza/Width <sup>2</sup>	120-200cm 50-130cm	+20%	100-200cm 15-120cm	+20%
Altre forme Other shapes <sup>2</sup>		+30%		+30%

OPTIONAL	COD.	[€]
Profilo compensazione Compensation Profile	COM10D (+4cm)	90,00
StarClean	Porta/Door	50,00
	Parete Fissa/Fixed Panel	50,00

<sup>1</sup> Dal prezzo della misura di riferimento/From the price of selected size

<sup>2</sup> Dal prezzo della misura superiore/From the price of the larger size

<sup>3</sup> Da richiedere al momento dell'ordine/To be requested at the time of order

DISPONIBILITA' A MAGAZZINO / STOCK AVAILABILITY

1/2 Settimane/Weeks +1 StarClean Optional	2/3 Settimane/Weeks	3/4 Settimane/Weeks
--	---------------------	---------------------

# AMERICA QUATTRO SP

ANGOLO DUE PORTE SCORREVOLE COMPLETO  
COMPLETE CORNER WITH TWO SLIDING DOORS



Per istruzioni di montaggio  
e ricambi inquadra il codice QR  
For assembly instructions  
and spare parts, scan the QR code



H. 190cm  
SP. 4mm



Parete doccia ad angolo a quattro ante, apertura ad ante scorrevoli nell'angolo del prodotto. Modello adatto per la maggior parte delle installazioni e disponibile in un'ampia gamma di dimensioni, soprattutto per chi vuole massimizzare le dimensioni d'ingresso.

Corner shower wall with four panels, featuring sliding doors at the corner of the product. Suitable for most installations and available in a wide range of sizes, especially for those looking to maximize the entry dimensions.

## CONFIGURAZIONE AD ANGOLO CORNER CONFIGURATION

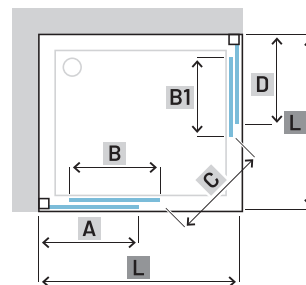

## CONFIGURAZIONE A TRE LATI THREE-SIDED CONFIGURATION

Per le configurazioni a tre lati considerare due volte la parete fissa (L1) specificando correttamente l'orientamento (destra o sinistra).  
For three-sided configurations, consider the fixed panel (L1) twice, specifying the correct orientation (right or left).

## ORIENTAMENTO E POSSIBILI COMBINAZIONI / ORIENTATION AND POSSIBLE CONFIGURATIONS

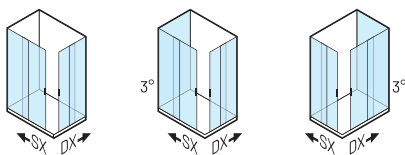

### PROFILI / PROFILES

STANDARD	
ULU	Brillantato Lucido Brilliant Polished
L91	Bianco Opaco Matte White
L96	Nero Opaco Matte Black

### VETRO / GLASS

STANDARD	
TR	Trasparente Transparent
RF	Fascia H.100cm Band H.100cm

**PORTA / DOOR**

L [cm]	COD.	A [cm]	B [cm]	B1 [cm]	C [cm]	D [cm]	[dm <sup>3</sup> ]	[kg]	[Pcs]	V	ULU	L91	L96
67-69	B6312	32-34	32,5	32,5	36	32-34	170	27	1	TR	715,00	715,00	
										RF	895,00	895,00	
69-71	B6313	33-35	33,5	33,5	37	33-35	176	28	1	TR	715,00	715,00	
										RF	895,00	895,00	
73-75	B6314	35-37	35,5	35,5	40	35-37	184	30	1	TR	730,00	730,00	
										RF	915,00	915,00	
77-79	B6315	37-39	37,5	37,5	43	37-39	197	31	1	TR	750,00	750,00	
										RF	940,00	940,00	
79-81	B6316	38-40	38,5	38,5	44	38-40	202	33	1	TR	750,00	750,00	
										RF	940,00	940,00	
83-85	B6317	40-42	40,5	40,5	47	40-42	209	34	1	TR	770,00	770,00	
										RF	965,00	965,00	
87-89	B6318	42-44	42,5	42,5	50	42-44	218	36	1	TR	790,00	790,00	
										RF	990,00	990,00	
89-91	B6319	43-45	43,5	43,5	51	43-45	223	37	1	TR	790,00	790,00	
										RF	990,00	990,00	
87-89/67-69	B6372	32-34	32,5	42,5	43	42-44	197	31	1	TR	745,00	745,00	
										RF	930,00	930,00	
89-91/73-75	B6374	35-37	35,5	43,5	45	43-45	202	33	1	TR	760,00	760,00	
										RF	950,00	950,00	
99-101/79-81	B6376	38-40	38,5	48,5	51	48-50	223	37	1	TR	820,00	820,00	
										RF	1.025,00	1.025,00	
99-101/67-69	B6378	32-34	32,5	48,5	47	48-50	206	34	1	TR	775,00	775,00	
										RF	970,00	970,00	

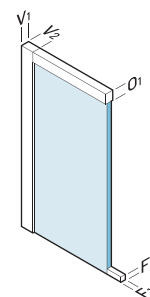

L	
V <sub>1</sub>	28mm
V <sub>2</sub>	40mm
O <sub>1</sub>	45mm
F <sub>1</sub>	10mm
F <sub>2</sub>	10mm

**PARETE FISSA / FIXED PANEL**

H. 190cm  
SP. 4mm

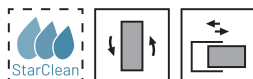

L1 [cm]	COD.	A [cm]	B [cm]	B1 [cm]	C [cm]	D [cm]	[dm <sup>3</sup> ]	[kg]	[Pcs]	V	ULU	L91	L96
63-65	B6321	-	-	-	-	-	117	16	1	TR	360,00	360,00	
										RF	450,00	450,00	
67-69	B6322	-	-	-	-	-	131	18	1	TR	360,00	360,00	
										RF	450,00	450,00	
69-71	B6323	-	-	-	-	-	148	19	1	TR	360,00	360,00	
										RF	450,00	450,00	
73-75	B6324	-	-	-	-	-	155	20	1	TR	360,00	360,00	
										RF	450,00	450,00	
77-79	B6325	-	-	-	-	-	163	21	1	TR	385,00	385,00	
										RF	480,00	480,00	
79-81	B6326	-	-	-	-	-	170	22	1	TR	385,00	385,00	
										RF	480,00	480,00	
83-85	B6327	-	-	-	-	-	175	23	1	TR	385,00	385,00	
										RF	480,00	480,00	
87-89	B6328	-	-	-	-	-	170	22	1	TR	405,00	405,00	
										RF	505,00	505,00	
89-91	B6329	-	-	-	-	-	175	23	1	TR	405,00	405,00	
										RF	505,00	505,00	

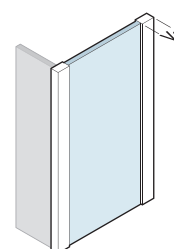

L1	
V <sub>2</sub>	45mm

OPTIONAL	COD.	[€]	
Profilo compensazione Compensation Profile	COM10D	ULU	90,00
	(+4cm)	L91-L96	90,00
StarClean	Porta/Door		100,00
	Parete Fissa/Fixed Panel		50,00

DISPONIBILITA' A MAGAZZINO / STOCK AVAILABILITY

1/2 Settimane/Weeks	2/3 Settimane/Weeks	3/4 Settimane/Weeks
+1 StarClean Optional		

# AMERICA QUATTRO SP

PORTA SCORREVOLE  
SLIDING DOOR



Per istruzioni di montaggio  
e ricambi inquadra il codice QR  
For assembly instructions  
and spare parts, scan the QR code



H. 190cm  
SP. 4mm



Parete doccia a due ante con apertura laterale scorrevole. Modello adatto per la maggior parte delle installazioni e disponibile in un'ampia gamma di dimensioni.

Shower wall with two panels and side sliding opening. Suitable for most installations and available in a wide range of sizes.

CONFIGURAZIONE IN NICCHIA  
NICHE CONFIGURATION

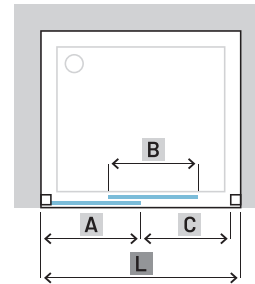

CONFIGURAZIONE AD ANGOLO  
CORNER CONFIGURATION

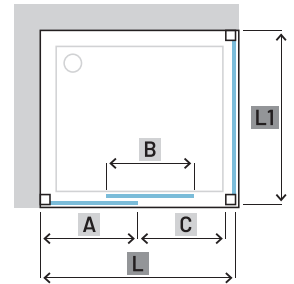

! CONFIGURAZIONE A TRE LATI  
THREE-SIDED CONFIGURATION

Per le configurazioni a tre lati considerare due volte la parete fissa (L1) specificando correttamente l'orientamento (destra o sinistra).

For three-sided configurations, consider the fixed panel (L1) twice, specifying the correct orientation (right or left).

## ORIENTAMENTO E POSSIBILI COMBINAZIONI / ORIENTATION AND POSSIBLE CONFIGURATIONS

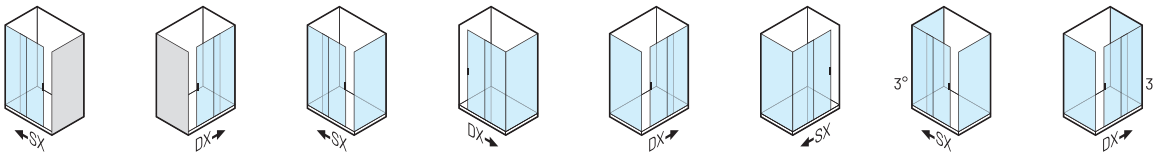

### PROFILI / PROFILES

STANDARD	
ULU	Brillantato Lucido Brilliant Polished
L91	Bianco Opaco Matte White
L96	Nero Opaco Matte Black

### VETRO / GLASS

STANDARD	
TR	Trasparente Transparent
RF	Fascia H.100cm Band H.100cm

## PORTA / DOOR

L [cm]	COD.	A [cm]	B [cm]	C [cm]	[dm <sup>3</sup> ]	[kg]	[Pcs]	V	ULU	L91	L96
96-100	<b>B6340</b>	46-48	46,5	40	121	24	1	TR	655,00	655,00	
								RF	820,00	820,00	
100-104	<b>B6341</b>	48-50	48,5	41	126	25	1	TR	655,00	655,00	
								RF	820,00	820,00	
106-110	<b>B6342</b>	51-53	51,5	44	132	26	1	TR	655,00	655,00	
								RF	820,00	820,00	
110-114	<b>B6343</b>	53-55	53,5	46	137	27	1	TR	655,00	655,00	
								RF	820,00	820,00	
116-120	<b>B6344</b>	56,5-58,5	56	49	143	28	1	TR	655,00	655,00	
								RF	820,00	820,00	
120-124	<b>B6345</b>	58-60	58,5	51	149	29	1	TR	690,00	690,00	
								RF	865,00	865,00	
126-130	<b>B6346</b>	61-63	61,5	54	155	30	1	TR	690,00	690,00	
								RF	865,00	865,00	
130-134	<b>B6347</b>	65-67	61,5	54	161	31	1	TR	725,00	725,00	
								RF	905,00	905,00	
136-140	<b>B6348</b>	66-68	66,5	59	167	32	1	TR	760,00	760,00	
								RF	950,00	950,00	
140-144	<b>B6349</b>	70-72	66,5	59	173	33	1	TR	760,00	760,00	
								RF	950,00	950,00	
146-150	<b>B6350</b>	71-73	71,5	64	179	34	1	TR	800,00	800,00	
								RF	1.000,00	1.000,00	
156-160	<b>B6351</b>	76-78	76,5	69	185	35	1	TR	840,00	840,00	
								RF	1.050,00	1.050,00	
160-164	<b>B6352</b>	80-82	76,5	69	191	36	1	TR	840,00	840,00	
								RF	1.050,00	1.050,00	
166-170	<b>B6354</b>	81-83	81,5	74	197	37	1	TR	885,00	885,00	
								RF	1.105,00	1.105,00	
170-174	<b>B6356</b>	85-87	81,5	74	203	38	1	TR	885,00	885,00	
								RF	1.105,00	1.105,00	
176-180	<b>B6358</b>	86-88	86,5	79	209	39	1	TR	885,00	885,00	
								RF	1.105,00	1.105,00	

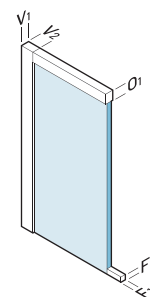

L	
V <sub>1</sub>	45mm
V <sub>2</sub>	40mm
O <sub>1</sub>	45mm
F <sub>1</sub>	10mm
F <sub>2</sub>	10mm

## PARETE FISSA / FIXED PANEL

H. 190cm  
SP. 4mm

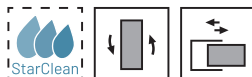

L1 [cm]	COD.	A [cm]	B [cm]	C [cm]	[dm <sup>3</sup> ]	[kg]	[Pcs]	V	ULU	L91	L96
63-65	<b>B6321</b>	-	-	-	117	16	1	TR	360,00	360,00	
								RF	450,00	450,00	
67-69	<b>B6322</b>	-	-	-	131	18	1	TR	360,00	360,00	
								RF	450,00	450,00	
69-71	<b>B6323</b>	-	-	-	148	19	1	TR	360,00	360,00	
								RF	450,00	450,00	
73-75	<b>B6324</b>	-	-	-	155	20	1	TR	360,00	360,00	
								RF	450,00	450,00	
77-79	<b>B6325</b>	-	-	-	163	21	1	TR	385,00	385,00	
								RF	480,00	480,00	
79-81	<b>B6326</b>	-	-	-	170	22	1	TR	385,00	385,00	
								RF	480,00	480,00	
83-85	<b>B6327</b>	-	-	-	175	23	1	TR	385,00	385,00	
								RF	480,00	480,00	
87-89	<b>B6328</b>	-	-	-	170	22	1	TR	405,00	405,00	
								RF	505,00	505,00	
89-91	<b>B6329</b>	-	-	-	175	23	1	TR	405,00	405,00	
								RF	505,00	505,00	

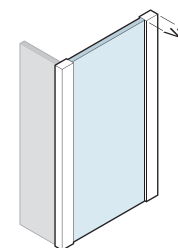

L1	
V <sub>2</sub>	35mm

SU MISURA/CUSTOM	PORTA DOOR	[€]	PARETE FISSA FIXED PANEL	[€]
↕ Altezza/Height <sup>1</sup>	120-200cm	+20%	100-200cm	+20%
↔ Larghezza/Width <sup>2</sup>	80-180cm	+20%	15-120cm	+20%
↕ Altezza/Height ↔ Larghezza/Width <sup>2</sup>	120-200cm 80-180cm	+20%	100-200cm 15-120cm	+20%
Altre forme Other shapes <sup>2</sup>		+30%		+30%

OPTIONAL	COD.	[€]
Profilo compensazione Compensation Profile	<b>COM10D</b> (+4cm)	ULU 90,00 L91-L96 90,00
	Porta/Door	50,00
	Parete Fissa/Fixed Panel	50,00

<sup>1</sup> Dal prezzo della misura di riferimento/From the price of selected size

<sup>2</sup> Dal prezzo della misura superiore/From the price of the larger size

<sup>3</sup> Da richiedere al momento dell'ordine/To be requested at the time of order

DISPONIBILITÀ A MAGAZZINO / STOCK AVAILABILITY

1/2 Settimane/Weeks +1 StarClean Optional	2/3 Settimane/Weeks	3/4 Settimane/Weeks
--	---------------------	---------------------

# AMERICA QUATTRO SP

DOPPIA PORTA SCORREVOLE  
DOUBLE SLIDING DOOR



Per istruzioni di montaggio  
e ricambi inquadra il codice QR  
For assembly instructions  
and spare parts, scan the QR code



H. 190cm  
SP. 4mm

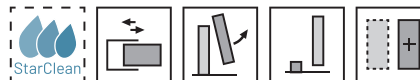

Parete doccia a quattro ante con apertura centrale. L'apertura è centrale data dalle due ante centrali scorrevoli in modo contrapposto. Modello adatto per installazioni di generose dimensioni.

Shower enclosure with four panels and a central opening. The opening is created by the two central sliding doors, which move in opposite directions. This model is suitable for large-scale installations.

CONFIGURAZIONE IN NICCHIA  
NICHE CONFIGURATION

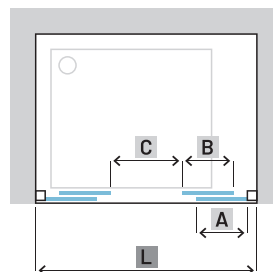

CONFIGURAZIONE AD ANGOLO  
CORNER CONFIGURATION

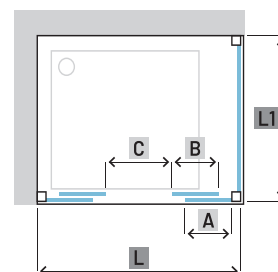

CONFIGURAZIONE A TRE LATI  
THREE-SIDED CONFIGURATION

Per le configurazioni a tre lati considerare due volte la parete fissa (L1) specificando correttamente l'orientamento (destra o sinistra).  
For three-sided configurations, consider the fixed panel (L1) twice, specifying the correct orientation (right or left).

## ORIENTAMENTO E POSSIBILI COMBINAZIONI / ORIENTATION AND POSSIBLE CONFIGURATIONS

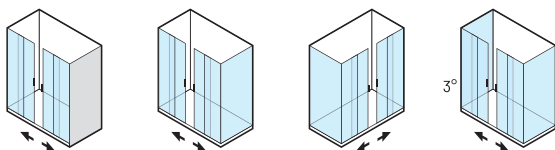

### PROFILI / PROFILES

STANDARD	
ULU	Brillantato Lucido Brilliant Polished
L91	Bianco Opaco Matte White
L96	Nero Opaco Matte Black

### VETRO / GLASS

STANDARD	
TR	Trasparente Transparent
RF	Fascia H.100cm Band H.100cm

## PORTA / DOOR

L [cm]	COD.	A [cm]	B [cm]	C [cm]	[dm <sup>3</sup> ]	[kg]	[n°]	V	ULU	L91	L96
136-140	B6363	35-37	34	56	170	35	1	TR	805,00	805,00	
								RF	1.005,00	1.005,00	
140-144	B6364	36-38	35	57	176	37	1	TR	805,00	805,00	
								RF	1.005,00	1.005,00	
146-150	B6365	37-39	37	61	184	38	1	TR	840,00	840,00	
								RF	1.050,00	1.050,00	
150-154	B6366	38-40	38	63	197	39	1	TR	840,00	840,00	
								RF	1.050,00	1.050,00	
156-160	B6367	40-42	39	65	202	40	1	TR	875,00	875,00	
								RF	1.095,00	1.095,00	
160-164	B6368	41-43	40	67	209	41	1	TR	875,00	875,00	
								RF	1.095,00	1.095,00	
166-170	B6369	42-44	42	71	218	42	1	TR	900,00	900,00	
								RF	1.125,00	1.125,00	

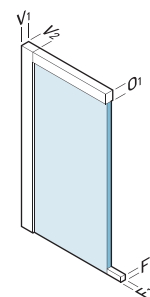

L	
V <sub>1</sub>	45mm
V <sub>2</sub>	40mm
O <sub>1</sub>	45mm
F <sub>1</sub>	10mm
F <sub>2</sub>	10mm

## PARETE FISSA / FIXED PANEL

H. 190cm  
SP. 4mm

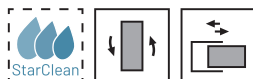

L1 [cm]	COD.	A [cm]	B [cm]	C [cm]	[dm <sup>3</sup> ]	[kg]	[Pcs]	V	ULU	L91	L96
63-65	B6321	-	-	-	117	16	1	TR	360,00	360,00	
								RF	450,00	450,00	
67-69	B6322	-	-	-	131	18	1	TR	360,00	360,00	
								RF	450,00	450,00	
69-71	B6323	-	-	-	148	19	1	TR	360,00	360,00	
								RF	450,00	450,00	
73-75	B6324	-	-	-	155	20	1	TR	360,00	360,00	
								RF	450,00	450,00	
77-79	B6325	-	-	-	163	21	1	TR	385,00	385,00	
								RF	480,00	480,00	
79-81	B6326	-	-	-	170	22	1	TR	385,00	385,00	
								RF	480,00	480,00	
83-85	B6327	-	-	-	175	23	1	TR	385,00	385,00	
								RF	480,00	480,00	
87-89	B6328	-	-	-	170	22	1	TR	405,00	405,00	
								RF	505,00	505,00	
89-91	B6329	-	-	-	175	23	1	TR	405,00	405,00	
								RF	505,00	505,00	

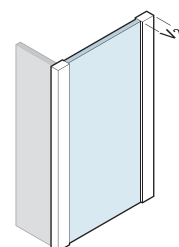

L1	
V <sub>2</sub>	35mm

SU MISURA/CUSTOM	PORTA DOOR	[€]	PARETE FISSA FIXED PANEL	[€]
▲ ▼ Altezza/Height <sup>1</sup>	120-200cm	+20%	100-200cm	+20%
◀ ▶ Larghezza/Width <sup>2</sup>	100-200cm	+20%	15-120cm	+20%
◆ ▲ Altezza/Height ◆ ▼ Larghezza/Width <sup>2</sup>	120-200cm 100-200cm	+20%	100-200cm 15-120cm	+20%
Altre forme Other shapes <sup>2</sup>		+30%		+30%

OPTIONAL	COD.	[€]
Profilo compensazione Compensation Profile	COM10D (+4cm)	ULU 90,00 L91-L96 90,00
	Porta/Door	100,00
	Parete Fissa/Fixed Panel	50,00

<sup>1</sup> Dal prezzo della misura di riferimento/From the price of selected size

<sup>2</sup> Dal prezzo della misura superiore/From the price of the larger size

<sup>3</sup> Da richiedere al momento dell'ordine/To be requested at the time of order

DISPONIBILITÀ A MAGAZZINO / STOCK AVAILABILITY

1/2 Settimane/Weeks

2/3 Settimane/Weeks

3/4 Settimane/Weeks

+1 StarClean Optional

# AMERICA QUATTRO SP

PORTA SALOON  
SALOON DOOR



Per istruzioni di montaggio  
e ricambi inquadra il codice QR  
For assembly instructions  
and spare parts, scan the QR code



H. 190cm  
SP. 4mm

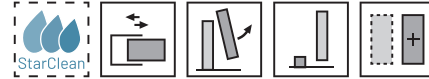

Parete doccia con due ante con apertura a saloon. L'apertura delle ante è sia verso l'interno che verso l'esterno. Modello adatto per situazioni che necessitano di un ingresso ampio, ma con spazio di installazione limitato.

Shower enclosure with two saloon-style doors. The doors open both inward and outward. A model suitable for situations requiring a wide entry but with limited installation space.

CONFIGURAZIONE IN NICCHIA  
NICHE CONFIGURATION

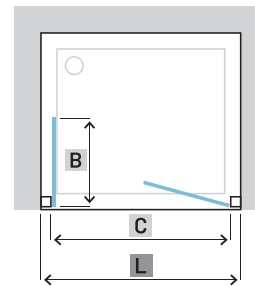

CONFIGURAZIONE AD ANGOLO  
CORNER CONFIGURATION

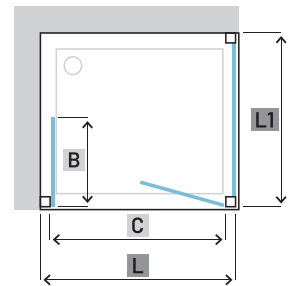

! CONFIGURAZIONE A TRE LATI  
THREE-SIDED CONFIGURATION

Per le configurazioni a tre lati considerare due volte la parete fissa (L1) specificando correttamente l'orientamento (destra o sinistra).  
For three-sided configurations, consider the fixed panel (L1) twice, specifying the correct orientation (right or left).

## ORIENTAMENTO E POSSIBILI COMBINAZIONI / ORIENTATION AND POSSIBLE CONFIGURATIONS

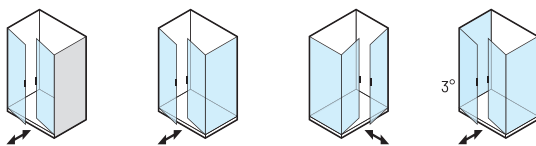

### PROFILI / PROFILES

STANDARD	
ULU	Brillantato Lucido Brilliant Polished
L91	Bianco Opaco Matte White
L96	Nero Opaco Matte Black

### VETRO / GLASS

STANDARD	
TR	Trasparente Transparent
RF	Fascia H.100cm Band H.100cm

## PORTA / DOOR

L [cm]	COD.	B [cm]	C [cm]	[dm <sup>3</sup> ]	[kg]	[n°]	V	ULU	L91	L96
66-70	B6331	24	54	117	16	1	TR	630,00	630,00	
							RF	790,00	790,00	
70-74	B6332	26	58	131	18	1	TR	630,00	630,00	
							RF	790,00	790,00	
76-80	B6333	29	64	148	19	1	TR	660,00	660,00	
							RF	825,00	825,00	
80-84	B6334	31	68	155	20	1	TR	660,00	660,00	
							RF	825,00	825,00	
86-90	B6335	34	74	163	21	1	TR	685,00	685,00	
							RF	855,00	855,00	
90-94	B6336	36	78	170	22	1	TR	685,00	685,00	
							RF	855,00	855,00	
96-100	B6337	39	84	175	23	1	TR	710,00	710,00	
							RF	890,00	890,00	

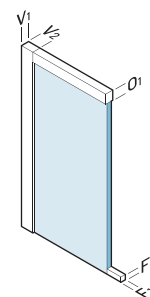

L	
V <sub>1</sub>	45mm
V <sub>2</sub>	40mm
O <sub>1</sub>	45mm
F <sub>1</sub>	10mm
F <sub>2</sub>	10mm

## PARETE FISSA / FIXED PANEL

H. 190cm  
SP. 4mm

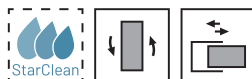

L1 [cm]	COD.	B [cm]	C [cm]	[dm <sup>3</sup> ]	[kg]	[Pcs]	V	ULU	L91	L96
63-65	B6321	-	-	117	16	1	TR	360,00	360,00	
							RF	450,00	450,00	
67-69	B6322	-	-	131	18	1	TR	360,00	360,00	
							RF	450,00	450,00	
69-71	B6323	-	-	148	19	1	TR	360,00	360,00	
							RF	450,00	450,00	
73-75	B6324	-	-	155	20	1	TR	360,00	360,00	
							RF	450,00	450,00	
77-79	B6325	-	-	163	21	1	TR	385,00	385,00	
							RF	480,00	480,00	
79-81	B6326	-	-	170	22	1	TR	385,00	385,00	
							RF	480,00	480,00	
83-85	B6327	-	-	175	23	1	TR	385,00	385,00	
							RF	480,00	480,00	
87-89	B6328	-	-	170	22	1	TR	405,00	405,00	
							RF	505,00	505,00	
89-91	B6329	-	-	175	23	1	TR	405,00	405,00	
							RF	505,00	505,00	

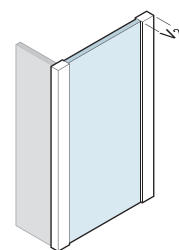

L1	
V <sub>2</sub>	35mm

SU MISURA/CUSTOM	PORTA DOOR	[€]	PARETE FISSA FIXED PANEL	[€]
▲ ▼ Altezza/Height <sup>1</sup>	100-200cm	+20%	100-200cm	+20%
◀ ▶ Larghezza/Width <sup>2</sup>	50-120cm	+20%	15-120cm	+20%
◆ ▲ Altezza/Height ◆ ▼ Larghezza/Width <sup>2</sup>	100-200cm 50-120cm	+20%	100-200cm 15-120cm	+20%
Altre forme Other shapes <sup>2</sup>		+30%		+30%

OPTIONAL	COD.	[€]
Profilo compensazione Compensation Profile	COM10D (+4cm)	ULU L91-L96
		90,00
StarClean	Porta/Door Parete Fissa/Fixed Panel	50,00 50,00

<sup>1</sup> Dal prezzo della misura di riferimento/From the price of selected size

<sup>2</sup> Dal prezzo della misura superiore/From the price of the larger size

<sup>3</sup> Da richiedere al momento dell'ordine/To be requested at the time of order

DISPONIBILITA' A MAGAZZINO / STOCK AVAILABILITY

1/2 Settimane/Weeks

2/3 Settimane/Weeks

3/4 Settimane/Weeks

+1 StarClean Optional

# AMERICA QUATTRO SP

PARETE FISSA  
FIXED PANEL



Per istruzioni di montaggio  
e ricambi inquadra il codice QR  
For assembly instructions  
and spare parts, scan the QR code



H. 190cm  
SP. 4mm

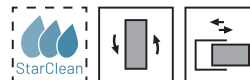

Parete fissa per abbinamenti. È possibile utilizzarla in abbinamento al modello di parete doccia selezionato per realizzare installazioni ad angolo o a tre lati quando possibile.

*Fixed panel for combinations. It can be used in combination with the selected shower enclosure model to create corner or three-sided installations where possible.*



### ! CONFIGURAZIONE A TRE LATI THREE-SIDED CONFIGURATION

Per le configurazioni a tre lati considerare due volte la parete fissa (L1) specificando correttamente l'orientamento (destra o sinistra).  
*For three-sided configurations, consider the fixed panel (L1) twice, specifying the correct orientation (right or left).*

## ORIENTAMENTO E POSSIBILI COMBINAZIONI / ORIENTATION AND POSSIBLE CONFIGURATIONS

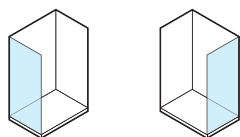

### PROFILI / PROFILES

STANDARD	
ULU	Brillantato Lucido <i>Brilliant Polished</i>
L91	Bianco Opaco <i>Matte White</i>
L96	Nero Opaco <i>Matte Black</i>

### VETRO / GLASS

STANDARD	
TR	Trasparente <i>Transparent</i>
RF	Fascia H.100cm <i>Band H.100cm</i>

**PARETE FISSA / FIXED PANEL**

L1 [cm]	COD.	A [cm]	B [cm]	C [cm]	[dm <sup>3</sup> ]	[kg]	[Pcs]	V	ULU	L91	L96
63-65	B6321	-	-	-	117	16	1	TR	360,00	360,00	
								RF	450,00	450,00	
67-69	B6322	-	-	-	131	18	1	TR	360,00	360,00	
								RF	450,00	450,00	
69-71	B6323	-	-	-	148	19	1	TR	360,00	360,00	
								RF	450,00	450,00	
73-75	B6324	-	-	-	155	20	1	TR	360,00	360,00	
								RF	450,00	450,00	
77-79	B6325	-	-	-	163	21	1	TR	385,00	385,00	
								RF	480,00	480,00	
79-81	B6326	-	-	-	170	22	1	TR	385,00	385,00	
								RF	480,00	480,00	
83-85	B6327	-	-	-	175	23	1	TR	385,00	385,00	
								RF	480,00	480,00	
87-89	B6328	-	-	-	170	22	1	TR	405,00	405,00	
								RF	505,00	505,00	
89-91	B6329	-	-	-	175	23	1	TR	405,00	405,00	
								RF	505,00	505,00	

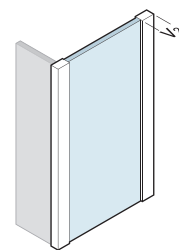

**L1**  
V<sub>2</sub> 35mm

SU MISURA/CUSTOM	PARETE FISSA FIXED PANEL	[€]
↕ Altezza/Height <sup>1</sup>	100-200cm	+20%
↔ Larghezza/Width <sup>2</sup>	15-120cm	+20%
↕ Altezza/Height ↔ Larghezza/Width <sup>2</sup>	100-200cm 15-120cm	+20%
Altre forme Other shapes <sup>2</sup>		+30%

OPTIONAL	COD.	[€]	
Profilo compensazione Compensation Profile	COM10D (+4cm)	ULU L91-L96	90,00 90,00
 StarClean	Parete Fissa/Fixed Panel		50,00

<sup>1</sup> Dal prezzo della misura di riferimento/From the price of selected size

<sup>2</sup> Dal prezzo della misura superiore/From the price of the larger size

<sup>3</sup> Da richiedere al momento dell'ordine/To be requested at the time of order

**DISPONIBILITÀ A MAGAZZINO / STOCK AVAILABILITY**

**1/2** Settimane/Weeks  
**+1** StarClean Optional

**2/3** Settimane/Weeks

**3/4** Settimane/Weeks

# AMERICA







- > Parete doccia con telaio
- > Vetro temperato 3mm per tutta la gamma
- > Trattamento anticalcare StarClean disponibile su richiesta
- > Estensibilità e regolazione fuori squadra del muro fino a 4cm
- > Maniglia e componentistica in finitura con il telaio

- > Shower enclosure with frame
- > 3mm tempered glass across the entire range
- > StarClean anti-limescale treatment available upon request
- > Adjustability and wall misalignment correction up to 4cm
- > Handle and components matching the frame finish

# AMERICA

## PRODOTTI DELLA SERIE / PRODUCTS OF THE SERIES

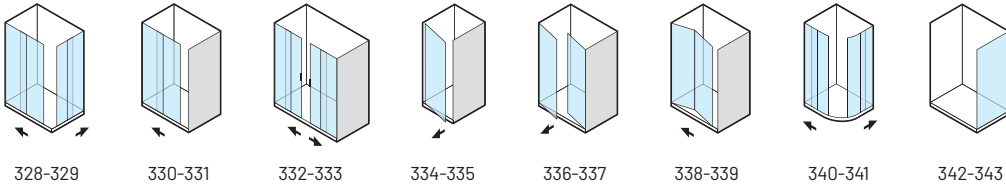

## PROFILI / PROFILES

### STANDARD



### L01

Bianco Lucido  
Glossy White

## VETRO / GLASS

### STANDARD



### TR

Trasparente  
Transparent

### ST

Stampato  
Printed

### JU

Juta  
Jute

# AMERICA

## ANGOLO DUE PORTE SCORREVOLI COMPLETO COMPLETE CORNER TWO SLIDING DOORS



Per istruzioni di montaggio  
e ricambi inquadra il codice QR  
For assembly instructions  
and spare parts, scan the QR code



**H. 185cm**  
**SP. 3mm**

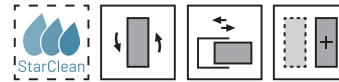

Parete doccia ad angolo a quattro ante, apertura ad ante scorrevoli nell'angolo del prodotto. Modello adatto per la maggior parte delle installazioni e disponibile in un'ampia gamma di dimensioni, soprattutto per chi vuole massimizzare le dimensioni d'ingresso.

*Corner shower wall with four panels, featuring sliding doors at the corner of the product. Suitable for most installations and available in a wide range of sizes, especially for those looking to maximize the entry dimensions.*

### CONFIGURAZIONE AD ANGOLO CORNER CONFIGURATION

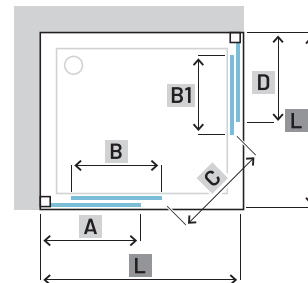

### CONFIGURAZIONI A TRE LATI THREE-SIDED CONFIGURATIONS

Per configurazioni a tre lati utilizzare la parete fissa standard America nella pagina seguente.

*For three-sided configurations, use the standard America fixed panel on the following page.*

### ORIENTAMENTO E POSSIBILI COMBINAZIONI / ORIENTATION AND POSSIBLE CONFIGURATIONS

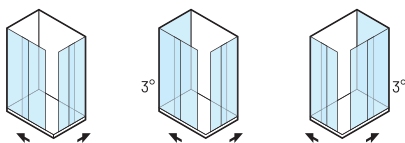

#### PROFILI / PROFILES

STANDARD	
L01	Bianco Lucido Glossy White

#### VETRO / GLASS

STANDARD	
TR	Trasparente Transparent
ST	Stampato Printed
JU	Juta Juta

**PORTA / DOOR**

L [cm]	COD.	A [cm]	B [cm]	B1 [cm]	C [cm]	D [cm]	[dm3]	[kg]	[Pcs]	V	L01
67-71	B6816	33,8-37,8	32	32	35	33,8-37,8	132	28	1	TR	495,00
								17	1	ST	520,00
								17	1	JU	520,00
73-77	B6817	36,8-40,8	35	35	39	36,8-40,8	142	30	1	TR	510,00
								18	1	ST	535,00
								18	1	JU	535,00
77-81	B6818	38,8-42,8	37	37	42	38,8-42,8	156	30	1	TR	525,00
								18	1	ST	550,00
								18	1	JU	550,00
83-87	B6822	41,8-45,8	40	40	46	41,8-45,8	171	34	1	TR	540,00
								19	1	ST	565,00
								19	1	JU	565,00
87-91	B6823	43,8-47,8	42	42	49	43,8-47,8	178	38	1	TR	555,00
								20	1	ST	585,00
								20	1	JU	585,00
67-71/83-87	B6830	33,8-37,8	32	40	40	41,8-45,8	164	30	1	TR	515,00
								18	1	ST	540,00
								18	1	JU	540,00
67-71/87-91	B6838	33,8-37,8	32	42	42	43,8-47,8	247	35	1	TR	540,00
								20	1	ST	565,00
								20	1	JU	565,00
67-71/97-101	B6896	33,8-37,8	32	47	46	48,8-52,8	195	33	1	TR	560,00
								19	1	ST	590,00
								19	1	JU	590,00
67-71/107-111	B6897	33,8-37,8	32	52	51	53,8-57,8	215	35	1	TR	570,00
								20	1	ST	600,00
								20	1	JU	600,00
67-71/117-121	B6898	33,8-37,8	32	57	54	58,8-62,8	235	35	1	TR	585,00
								21	1	ST	615,00
								21	1	JU	615,00
73-77/77-81	B6825	36,8-40,8	35	37	43	38,8-42,8	158	31	1	TR	515,00
								18	1	ST	540,00
								18	1	JU	540,00
73-77/87-91	B6824	36,8-40,8	35	42	45	43,8-47,8	186	32	1	TR	530,00
								19	1	ST	555,00
								19	1	JU	555,00
73-77/97-101	B6850	36,8-40,8	35	47	48	48,8-52,8	192	33	1	TR	540,00
								20	1	ST	565,00
								20	1	JU	565,00
77-81/97-101	B6840	38,8-42,8	37	47	50	48,8-52,8	192	35	1	TR	545,00
								20	1	ST	570,00
								20	1	JU	570,00
77-81/117-121	B6899	38,8-42,8	37	57	58	58,8-62,8	247	36	1	TR	600,00
								21	1	ST	630,00
								21	1	JU	630,00

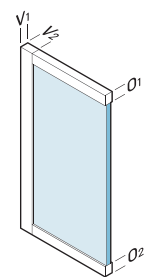

L	V1	V2	O1	O2
	35mm	50mm	35mm	35mm

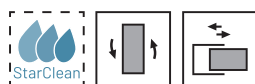
**PARETE FISSA / FIXED PANEL**
**H. 185cm**  
**SP. 3mm**

L1 [cm]	COD.	A [cm]	B [cm]	B1 [cm]	C [cm]	D [cm]	[dm3]	[kg]	[Pcs]	V	L01
68-76	B6819	-	-	-	-	-	140	15	1	TR	240,00
								10	1	ST	250,00
								10	1	JU	250,00
77-85	B6820	-	-	-	-	-	158	17	1	TR	250,00
								11	1	ST	265,00
								11	1	JU	265,00
86-94	B6821	-	-	-	-	-	175	18	1	TR	270,00
								12	1	ST	285,00
								12	1	JU	285,00

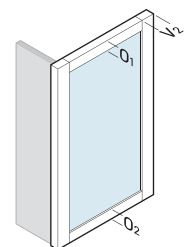

L1	V2	O1	O2
	50mm	35mm	35mm

SU MISURA/CUSTOM	PORTA DOOR	[€]	PARETE FISSA FIXED PANEL	[€]
Altezza/Height <sup>1</sup>	120-200cm	+20%	50-200cm	+20%
Larghezza/Width <sup>2</sup>	50-130cm	+20%	20-110cm	+20%
Altezza/Height Larghezza/Width <sup>2</sup>	120-200cm 50-130cm	+20%	50-200cm 20-110cm	+20%
Altre forme Other shapes <sup>2</sup>		+30%		+30%

OPTIONAL	COD.	[€]
Profilo compensazione Compensation Profile	COM7 (+4cm)	L01 60,00 ULU 90,00 SAR 90,00
	Porta/Door	100,00
	Parete Fissa/Fixed Panel	50,00

**DISPONIBILITA' A MAGAZZINO / STOCK AVAILABILITY**

1/2 Settimane/Weeks	2/3 Settimane/Weeks	3/4 Settimane/Weeks
+1 StarClean Optional		

<sup>1</sup> Dal prezzo della misura di riferimento / From the price of selected size

<sup>2</sup> Dal prezzo della misura superiore / From the price of the larger size

# AMERICA

PORTA SCORREVOLE  
SLIDING DOOR



Per istruzioni di montaggio  
e ricambi inquadra il codice QR  
For assembly instructions  
and spare parts, scan the QR code



H. 185cm  
SP. 3mm

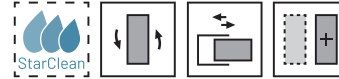

Parete doccia a due ante con apertura laterale scorrevole. Modello adatto per la maggior parte delle installazioni e disponibile in un'ampia gamma di dimensioni.

Shower wall with two panels and side sliding opening. Suitable for most installations and available in a wide range of sizes.

CONFIGURAZIONE IN NICCHIA  
NICHE CONFIGURATION

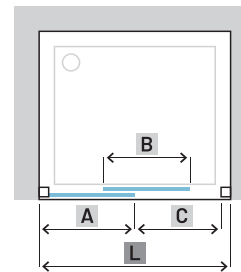

CONFIGURAZIONE IN ANGOLO  
CORNER CONFIGURATION

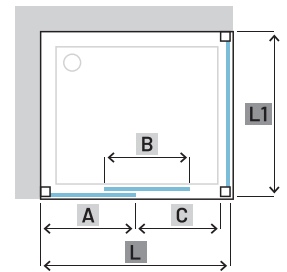

CONFIGURAZIONI A TRE LATI  
THREE-SIDED CONFIGURATIONS

Per configurazioni a tre lati utilizzare la parete fissa standard America nella pagina seguente.

For three-sided configurations, use the standard America fixed panel on the following page.

## ORIENTAMENTO E POSSIBILI COMBINAZIONI / ORIENTATION AND POSSIBLE CONFIGURATIONS

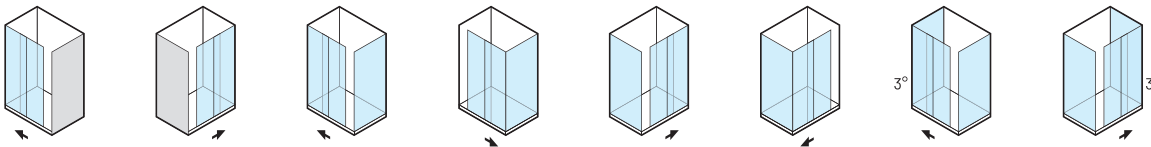

### PROFILI / PROFILES

#### STANDARD

L01 Bianco Lucido  
Glossy White

### VETRO / GLASS

#### STANDARD

TR Trasparente  
Transparent

ST Stampato  
Printed

JU Juta  
Juta

## PORTA / DOOR

L [cm]	COD.	A [cm]	B [cm]	C [cm]	[dm3]	[kg]	[Pcs]	V	L01
113-120	B6841	54,7-58,7	54,8	47	119	26	1	TR	420,00
								ST	440,00
								JU	440,00
121-128	B6842	58,7-62,7	58,8	51	141	27	1	TR	445,00
								ST	465,00
								JU	465,00
129-136	B6843	63,9-67,9	61,6	54	149	27	1	TR	470,00
								ST	495,00
								JU	495,00
136-143	B6805	66,9-70,9	65,6	57	155	28	1	TR	495,00
								ST	520,00
								JU	520,00
146-153	B6806	72,2-76,2	70,3	62	166	29	1	TR	520,00
								ST	545,00
								JU	545,00
156-163	B6807	77,2-81,2	75,3	67	176	30	1	TR	545,00
								ST	570,00
								JU	570,00
166-173	B6808	82,2-86,2	80,3	72	186	31	1	TR	580,00
								ST	610,00
								JU	610,00

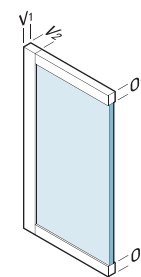

L	
V <sub>1</sub>	35mm
V <sub>2</sub>	50mm
O <sub>1</sub>	35mm
O <sub>2</sub>	35mm

## PARETE FISSA / FIXED PANEL

H. 185cm  
SP. 3mm

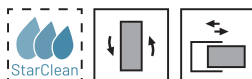

L1 [cm]	COD.	A [cm]	B [cm]	C [cm]	[dm3]	[kg]	[Pcs]	V	L01
68-76	B6819	-	-	-	140	15	1	TR	240,00
								ST	250,00
								JU	250,00
77-85	B6820	-	-	-	158	17	1	TR	250,00
								ST	265,00
								JU	265,00
86-94	B6821	-	-	-	175	18	1	TR	270,00
								ST	285,00
								JU	285,00

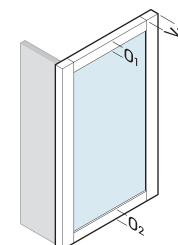

L1	
V <sub>2</sub>	50mm
O <sub>1</sub>	35mm
O <sub>4</sub>	35mm

SU MISURA/CUSTOM	PORTA DOOR	[€]	PARETE FISSA FIXED PANEL	[€]
▲▼ Altezza/Height <sup>1</sup>	120-200cm	+20%	50-200cm	+20%
◀▶ Larghezza/Width <sup>2</sup>	80-185cm	+20%	20-110cm	+20%
◆ Altezza/Height Larghezza/Width <sup>2</sup>	120-200cm 80-185cm	+20%	50-200cm 20-110cm	+20%
Altre forme Other shapes <sup>2</sup>		+30%		+30%

OPTIONAL	COD.	[€]
Profilo compensazione Compensation Profile	L01	60,00
	COM7 (+4cm)	90,00
	SAR	90,00
StarClean	Porta/Door	50,00
	Parete Fissa/Fixed Panel	50,00

<sup>1</sup> Dal prezzo della misura di riferimento / From the price of selected size

<sup>2</sup> Dal prezzo della misura superiore / From the price of the larger size

DISPONIBILITA' A MAGAZZINO / STOCK AVAILABILITY

1/2 Settimane/Weeks

2/3 Settimane/Weeks

3/4 Settimane/Weeks

+1 StarClean Optional

# AMERICA

DOPPIA PORTA SCORREVOLE  
DOUBLE SLIDING DOOR



Per istruzioni di montaggio  
e ricambi inquadra il codice QR  
For assembly instructions  
and spare parts, scan the QR code



H. 185cm  
SP. 3mm

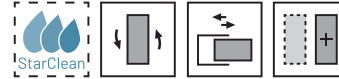

Parete doccia a quattro ante con apertura centrale. L'apertura è centrale data dalle due ante centrali scorrevoli in modo contrapposto. Modello adatto per installazioni di generose dimensioni.

Shower enclosure with four panels and a central opening. The opening is created by the two central sliding doors, which move in opposite directions. This model is suitable for large-scale installations.

CONFIGURAZIONE IN NICCHIA  
NICHE CONFIGURATION

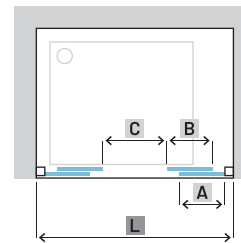

CONFIGURAZIONE IN ANGOLO  
CORNER CONFIGURATION

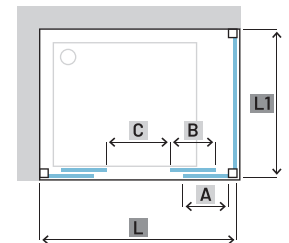

**CONFIGURAZIONI A TRE LATI  
THREE-SIDED CONFIGURATIONS**

Per configurazioni a tre lati utilizzare la parete fissa standard America nella pagina seguente.

For three-sided configurations, use the standard America fixed panel on the following page.

## ORIENTAMENTO E POSSIBILI COMBINAZIONI / ORIENTATION AND POSSIBLE CONFIGURATIONS

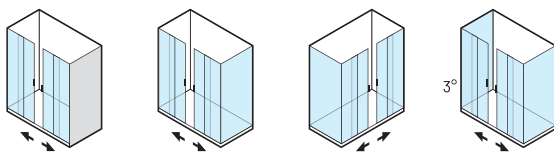

### PROFILI / PROFILES

STANDARD	
L01	Bianco Lucido Glossy White

### VETRO / GLASS

STANDARD	
TR	Trasparente Transparent
ST	Stampato Printed
JU	Juta Juta

## PORTA / DOOR

L [cm]	COD.	A [cm]	B [cm]	C [cm]	[dm3]	[kg]	[Pcs]	V	L01
137-144	B6844	36,5-40,5	35,1	55	159	30	1	TR	570,00
								ST	600,00
								JU	600,00
145-152	B6845	40,1-44,1	35,1	55	174	31	1	TR	595,00
								ST	625,00
								JU	625,00

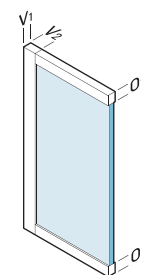

L	
V <sub>1</sub>	35mm
V <sub>2</sub>	50mm
O <sub>1</sub>	35mm
O <sub>2</sub>	35mm

## PARETE FISSA / FIXED PANEL

H. 185cm  
SP. 3mm

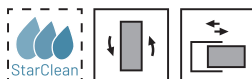

L1 [cm]	COD.	A [cm]	B [cm]	C [cm]	[dm3]	[kg]	[Pcs]	V	L01
68-76	B6819	-	-	-	140	15	1	TR	240,00
								ST	250,00
								JU	250,00
77-85	B6820	-	-	-	158	17	1	TR	250,00
								ST	265,00
								JU	265,00
86-94	B6821	-	-	-	175	18	1	TR	270,00
								ST	285,00
								JU	285,00

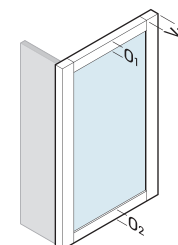

L1	
V <sub>2</sub>	50mm
O <sub>1</sub>	35mm
O <sub>4</sub>	35mm

SU MISURA/CUSTOM	PORTA DOOR	[€]	PARETE FISSA FIXED PANEL	[€]
▲▼ Altezza/Height <sup>1</sup>	120-200cm	+20%	50-200cm	+20%
◀▶ Larghezza/Width <sup>2</sup>	100-200cm	+20%	20-110cm	+20%
◆ Altezza/Height Larghezza/Width <sup>2</sup>	120-200cm 100-200cm	+20%	50-200cm 20-110cm	+20%
Altre forme Other shapes <sup>2</sup>		+30%		+30%

OPTIONAL	COD.	[€]
Profilo compensazione Compensation Profile	L01	60,00
	COM7 (+4cm)	90,00
	SAR	90,00
StarClean	Porta/Door	100,00
	Parete Fissa/Fixed Panel	50,00

<sup>1</sup> Dal prezzo della misura di riferimento / From the price of selected size

<sup>2</sup> Dal prezzo della misura superiore / From the price of the larger size

### DISPONIBILITA' A MAGAZZINO / STOCK AVAILABILITY

1/2 Settimane/Weeks	2/3 Settimane/Weeks	3/4 Settimane/Weeks
+1 StarClean Optional		

# AMERICA

## PORTA BATTENTE PIVOT PIVOT-HINGED DOOR



Per istruzioni di montaggio  
e ricambi inquadra il codice QR  
For assembly instructions  
and spare parts, scan the QR code



**H. 185cm**  
**SP. 3mm**

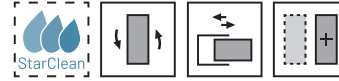

Parete doccia con apertura a porta battente pivotante. L'apertura dell'anta è verso l'esterno. Modello adatto per situazioni che necessitano di aperture generose, ma di ingombri minimizzati all'interno del bagno.

*Shower enclosure with a pivot-hinged door. The door opens outward. This model is suitable for situations requiring a generous opening while minimizing space usage inside the bathroom.*

### CONFIGURAZIONE IN NICCHIA NICHE CONFIGURATION

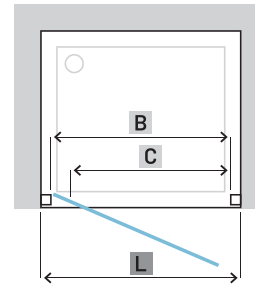

### CONFIGURAZIONE AD ANGOLO CORNER CONFIGURATION

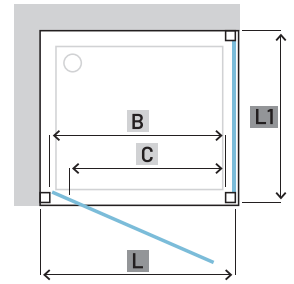

### CONFIGURAZIONI A TRE LATI THREE-SIDED CONFIGURATIONS

Non è possibile realizzare configurazioni a tre lati.  
*It is not possible to create three-sided configurations.*

### ORIENTAMENTO E POSSIBILI COMBINAZIONI / ORIENTATION AND POSSIBLE CONFIGURATIONS

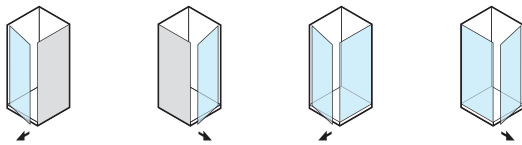

#### PROFILI / PROFILES

STANDARD	
L01	Bianco Lucido Glossy White

#### VETRO / GLASS

STANDARD	
TR	Trasparente Transparent
ST	Stampato Printed
JU	Juta Juta

## PORTA / DOOR

L [cm]	COD.	A [cm]	B [cm]	B1 [cm]	C [cm]	[dm3]	[kg]	[Pcs]	V	L01
68-76	B6835	14,5	58,2	43,8	45	115	17	1	TR	360,00
									ST	380,00
									JU	380,00
77-85	B6836	14,5	67,3	52,8	54	129	19	1	TR	380,00
									ST	400,00
									JU	400,00
86-94	B6837	14,5	76,3	61,8	63	143	20	1	TR	395,00
									ST	415,00
									JU	415,00

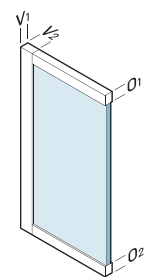

L	
V <sub>1</sub>	35mm
V <sub>2</sub>	50mm
O <sub>1</sub>	35mm
O <sub>2</sub>	35mm

## PARETE FISSA / FIXED PANEL

H. 185cm  
SP. 3mm

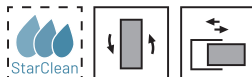

L1 [cm]	COD.	A [cm]	B [cm]	B1 [cm]	C [cm]	[dm3]	[kg]	[Pcs]	V	L01
68-76	B6819	-	-	-	-	140	15	1	TR	240,00
									ST	250,00
									JU	250,00
77-85	B6820	-	-	-	-	158	17	1	TR	250,00
									ST	265,00
									JU	265,00
86-94	B6821	-	-	-	-	175	18	1	TR	270,00
									ST	285,00
									JU	285,00

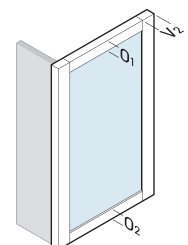

L1	
V <sub>2</sub>	50mm
O <sub>1</sub>	35mm
O <sub>4</sub>	35mm

SU MISURA/CUSTOM	PORTA DOOR	[€]	PARETE FISSA FIXED PANEL	[€]
Altezza/Height <sup>1</sup>	120-200cm	+20%	50-200cm	+20%
Larghezza/Width <sup>2</sup>	50-100cm	+20%	20-110cm	+20%
Altezza/Height Larghezza/Width <sup>2</sup>	120-200cm 50-100cm	+20%	50-200cm 20-110cm	+20%
Altre forme Other shapes <sup>2</sup>		+30%		+30%

OPTIONAL	COD.	[€]
Profilo compensazione Compensation Profile	L01	60,00
	COM7 (+4cm)	90,00
	SAR	90,00
StarClean	Porta/Door	50,00
	Parete Fissa/Fixed Panel	50,00

<sup>1</sup> Dal prezzo della misura di riferimento / From the price of selected size

<sup>2</sup> Dal prezzo della misura superiore / From the price of the larger size

### DISPONIBILITA' A MAGAZZINO / STOCK AVAILABILITY

1/2 Settimane/Weeks	2/3 Settimane/Weeks	3/4 Settimane/Weeks
+1 StarClean Optional		

# AMERICA

## PORTA SALOON SALOON DOOR



Per istruzioni di montaggio  
e ricambi inquadra il codice QR  
For assembly instructions  
and spare parts, scan the QR code



**H. 185cm**  
**SP. 3mm**

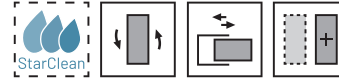

Parete doccia con due ante con apertura a saloon. L'apertura delle ante è verso l'esterno. Modello adatto per situazioni che necessitano di un ingresso ampio, ma con spazio di installazione limitato.

*Shower enclosure with two saloon-style doors. The doors open outward. This model is suitable for situations requiring a wide entrance but with limited installation space.*

### CONFIGURAZIONE IN NICCHIA NICHE CONFIGURATION

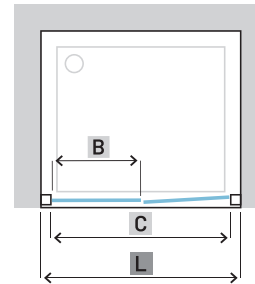

### CONFIGURAZIONE AD ANGOLO CORNER CONFIGURATION

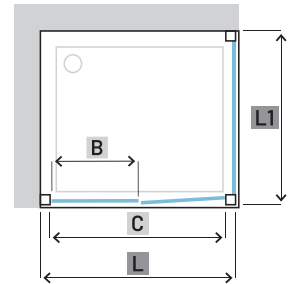

### CONFIGURAZIONI A TRE LATI THREE-SIDED CONFIGURATIONS

Per configurazioni a tre lati utilizzare la parete fissa standard America nella pagina seguente.

*For three-sided configurations, use the standard America fixed panel on the following page.*

### ORIENTAMENTO E POSSIBILI COMBINAZIONI / ORIENTATION AND POSSIBLE CONFIGURATIONS

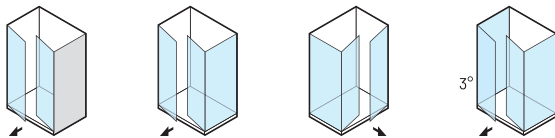

### PROFILI / PROFILES

#### STANDARD

**L01** Bianco Lucido  
Glossy White

### VETRO / GLASS

#### STANDARD

**TR** Trasparente  
Transparent

**ST** Stampato  
Printed

**JU** Juta  
Juta

## PORTA / DOOR

L [cm]	COD.	A [cm]	B [cm]	B1 [cm]	C [cm]	[dm3]	[kg]	[Pcs]	V	L01
68-76	B6826	10	30	20	45	89	17	1	TR	425,00
							13	1	ST	445,00
							13	1	JU	445,00
77-85	B6827	10	35	25	54	99	19	1	TR	440,00
							14	1	ST	460,00
							14	1	JU	460,00
86-94	B6828	10	39	29	63	112	20	1	TR	450,00
							15	1	ST	475,00
							15	1	JU	475,00
95-103	B6829	10	44	34	72	122	22	1	TR	465,00
							16	1	ST	490,00
							16	1	JU	490,00

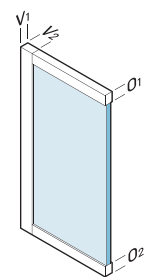

L	V1	V2	O1	O2
	35mm	50mm	35mm	35mm

## PARETE FISSA / FIXED PANEL

H. 185cm  
SP. 3mm

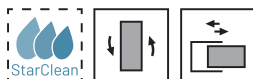

L1 [cm]	COD.	A [cm]	B [cm]	B1 [cm]	C [cm]	[dm3]	[kg]	[Pcs]	V	L01
68-76	B6819	-	-	-	-	140	15	1	TR	240,00
							10	1	ST	250,00
							10	1	JU	250,00
77-85	B6820	-	-	-	-	158	17	1	TR	250,00
							11	1	ST	265,00
							11	1	JU	265,00
86-94	B6821	-	-	-	-	175	18	1	TR	270,00
							12	1	ST	285,00
							12	1	JU	285,00

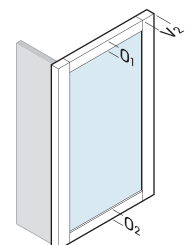

L1	V2	O1	O4
	50mm	35mm	35mm

SU MISURA/CUSTOM	PORTA DOOR	[€]	PARETE FISSA FIXED PANEL	[€]
▲▼ Altezza/Height <sup>1</sup>	120-200cm	+20%	50-200cm	+20%
◀▶ Larghezza/Width <sup>2</sup>	50-120cm	+20%	20-110cm	+20%
◆ Altezza/Height Larghezza/Width <sup>2</sup>	120-200cm 50-120cm	+20%	50-200cm 20-110cm	+20%
Altre forme Other shapes <sup>2</sup>		+30%		+30%

OPTIONAL	COD.	[€]
Profilo compensazione Compensation Profile	L01	60,00
	COM7 (+4cm)	90,00
	SAR	90,00
StarClean	Porta/Door	50,00
	Parete Fissa/Fixed Panel	50,00

<sup>1</sup> Dal prezzo della misura di riferimento / From the price of selected size

<sup>2</sup> Dal prezzo della misura superiore / From the price of the larger size

DISPONIBILITA' A MAGAZZINO / STOCK AVAILABILITY

1/2 Settimane/Weeks

2/3 Settimane/Weeks

3/4 Settimane/Weeks

+1 StarClean Optional

# AMERICA

## PORTA SOFFIETTO BIFOLDING DOOR



Per istruzioni di montaggio  
e ricambi inquadra il codice QR  
For assembly instructions  
and spare parts, scan the QR code



**H. 185cm**  
**SP. 3mm**

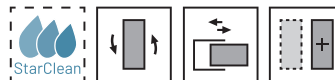

Parete doccia con due ante con apertura a soffietto. L'apertura delle ante è verso l'interno. Modello adatto per situazioni che necessitano di un ingresso ampio, ma con spazio di installazione limitato.

*Shower enclosure with two folding doors. The doors open inward. This model is suitable for situations requiring a wide entrance, but with limited installation space.*

### CONFIGURAZIONE IN NICCHIA NICHE CONFIGURATION

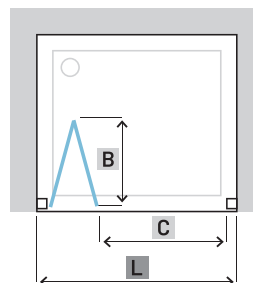

### CONFIGURAZIONE AD ANGOLO CORNER CONFIGURATION

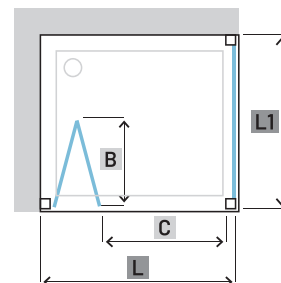

### CONFIGURAZIONI A TRE LATI THREE-SIDED CONFIGURATIONS

Per configurazioni a tre lati utilizzare la parete fissa standard America nella pagina seguente.

*For three-sided configurations, use the standard America fixed panel on the following page.*

### ORIENTAMENTO E POSSIBILI COMBINAZIONI / ORIENTATION AND POSSIBLE CONFIGURATIONS

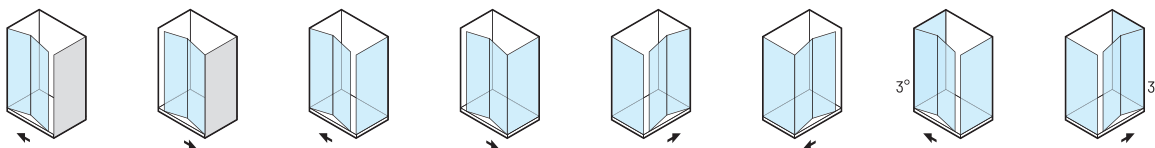

### PROFILI / PROFILES

#### STANDARD

**L01** Bianco Lucido  
Glossy White

### VETRO / GLASS

#### STANDARD

**TR** Trasparente  
Transparent

**ST** Stampato  
Printed

**JU** Juta  
Juta

## PORTA / DOOR

L [cm]	COD.	A [cm]	B [cm]	C [cm]	[dm3]	[kg]	[Pcs]	V	L01
68-76	B6831	-	32	49	90	19	1	TR	485,00
								ST	510,00
								JU	510,00
77-85	B6832	-	36	58	102	21	1	TR	495,00
								ST	520,00
								JU	520,00
86-94	B6833	-	40	67	113	23	1	TR	515,00
								ST	540,00
								JU	540,00
95-103	B6834	-	45	76	124	25	1	TR	530,00
								ST	555,00
								JU	555,00

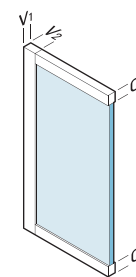

L	V1	V2	O1	O2
	35mm	50mm	35mm	35mm

## PARETE FISSA / FIXED PANEL

H. 185cm  
SP. 3mm

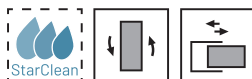

L1 [cm]	COD.	A [cm]	B [cm]	C [cm]	[dm3]	[kg]	[Pcs]	V	L01
68-76	B6819	-	-	-	140	15	1	TR	240,00
								ST	250,00
								JU	250,00
77-85	B6820	-	-	-	158	17	1	TR	250,00
								ST	265,00
								JU	265,00
86-94	B6821	-	-	-	175	18	1	TR	270,00
								ST	285,00
								JU	285,00

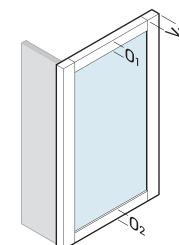

L1	V2	O1	O4
	50mm	35mm	35mm

SU MISURA/CUSTOM	PORTA DOOR	[€]	PARETE FISSA FIXED PANEL	[€]
▲▼ Altezza/Height <sup>1</sup>	120-200cm	+20%	50-200cm	+20%
◀▶ Larghezza/Width <sup>2</sup>	50-120cm	+20%	20-110cm	+20%
◆ Altezza/Height Larghezza/Width <sup>2</sup>	120-200cm 50-120cm	+20%	50-200cm 20-110cm	+20%
Altre forme Other shapes <sup>2</sup>		+30%		+30%

OPTIONAL	COD.	[€]
Profilo compensazione Compensation Profile	L01	60,00
	COM7 (+4cm)	90,00
	SAR	90,00
StarClean	Porta/Door	50,00
	Parete Fissa/Fixed Panel	50,00

<sup>1</sup> Dal prezzo della misura di riferimento / From the price of selected size

<sup>2</sup> Dal prezzo della misura superiore / From the price of the larger size

DISPONIBILITA' A MAGAZZINO / STOCK AVAILABILITY

1/2 Settimane/Weeks    2/3 Settimane/Weeks    3/4 Settimane/Weeks  
+1 StarClean Optional

# AMERICA

STONDATO DOPPIA PORTA SCORREVOLE  
ROUNDED DOUBLE SLIDING DOOR



Per istruzioni di montaggio  
e ricambi inquadra il codice QR  
For assembly instructions  
and spare parts, scan the QR code



H. 185cm  
SP. 3mm

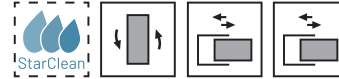

Parete doccia stondata disponibile in versioni per installazioni in angolo in dimensioni quadrate o rettangolari. Il modello dispone di quattro ante di cui le due centrali apribili.

Curved shower enclosure available in versions for corner installations in square or rectangular sizes. The model features four panels, with the two central ones being openable.

### CONFIGURAZIONE AD ANGOLO CORNER CONFIGURATION

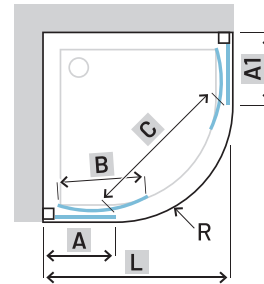

- B6870 R 38cm
- B6873 R 55cm
- B6872 R 55cm
- B6893 R 55cm
- B6895 R 55cm

### CONFIGURAZIONI A TRE LATI THREE-SIDED CONFIGURATIONS

Per configurazioni a tre lati utilizzare la parete fissa standard America nella pagina seguente.

For three-sided configurations, use the standard America fixed panel on the following page.

### ORIENTAMENTO E POSSIBILI COMBINAZIONI / ORIENTATION AND POSSIBLE CONFIGURATIONS

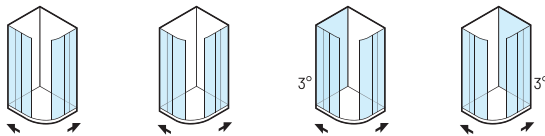

### PROFILI / PROFILES

STANDARD	
L01	Bianco Lucido Glossy White

### VETRO / GLASS

STANDARD	
TR	Trasparente Transparent
ST	Stampato Printed
JU	Juta Juta

## PORTA / DOOR

L [cm]	COD.	A [cm]	B [cm]	C [cm]	D [cm]	[dm <sup>3</sup> ]	[kg]	[Pcs]	V	L01
71,5-75,5	B6870	34,2-38,2	28	45	34,2-38,2	226	33	2	TR	645,00
									ST	675,00
						166	22	2	JU	675,00
76-80	B6873	22,7-26,7	41	40	22,7-26,7	266	34	2	TR	655,00
									ST	690,00
						176	23	2	JU	690,00
86-90	B6872	32,7-36,7	41	54	32,7-36,7	299	35	2	TR	690,00
									ST	725,00
						206	23	2	JU	725,00
66-70 / 86,5-90,5	B6893	28,7-32,7	28	39	49,2-53,2	229	33	2	TR	670,00
									ST	705,00
						202	19	2	JU	705,00
76-80 / 96,5-100,5	B6895	38,7-42,7	28	39	59,2-63,2	252	35	2	TR	715,00
									ST	750,00
						226	20	2	JU	750,00

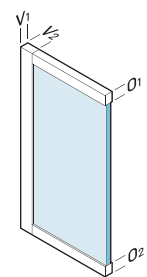

L	V1	V2	O1	O2
	35mm	50mm	35mm	35mm

## PARETE FISSA / FIXED PANEL

H. 185cm  
SP. 3mm

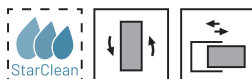

L1 [cm]	COD.	A [cm]	B [cm]	C [cm]	D [cm]	[dm <sup>3</sup> ]	[kg]	[Pcs]	V	L01
68-76	B6819	-	-	-	-	140	15	1	TR	240,00
									ST	250,00
									JU	250,00
77-85	B6820	-	-	-	-	158	17	1	TR	250,00
									ST	265,00
									JU	265,00
86-94	B6821	-	-	-	-	175	18	1	TR	270,00
									ST	285,00
									JU	285,00

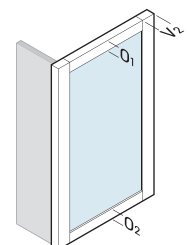

L1	V2	O1	O4
	50mm	35mm	35mm

SU MISURA/CUSTOM	PORTA DOOR	[€]	PARETE FISSA FIXED PANEL	[€]
▲▼ Altezza/Height <sup>1</sup>	Vedi nota/See note <sup>3</sup>	-	50-200cm	+20%
◀▶ Larghezza/Width <sup>2</sup>	Vedi nota/See note <sup>3</sup>	+20%	20-110cm	+20%
◆ Altezza/Height Larghezza/Width <sup>2</sup>	Vedi nota/See note <sup>3</sup>	-	50-200cm 20-110cm	+20%
Altre forme Other shapes <sup>2</sup>		+30%		+30%

OPTIONAL	COD.	[€]
Profilo compensazione Compensation Profile	L01	60,00
	COM7 (+4cm)	90,00
	SAR	90,00
StarClean	Porta/Door	100,00
	Parete Fissa/Fixed Panel	50,00

<sup>1</sup> Dal prezzo della misura di riferimento /From the price of selected size

<sup>2</sup> Dal prezzo della misura superiore /From the price of the larger size

<sup>3</sup> Contattare l'ufficio clienti per informazioni / Contact the customer service office for information

DISPONIBILITA' A MAGAZZINO / STOCK AVAILABILITY

1/2 Settimane/Weeks

2/3 Settimane/Weeks

3/4 Settimane/Weeks

+1 StarClean Optional

# AMERICA

PARETE FISSA  
FIXED PANEL



Per istruzioni di montaggio  
e ricambi inquadra il codice QR  
For assembly instructions  
and spare parts, scan the QR code



H. 185cm  
SP. 3mm

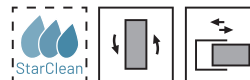

Parete fissa per abbinamenti. È possibile utilizzarla in abbinamento al modello di parete doccia selezionato per realizzare installazioni ad angolo o a tre lati quando possibile.

*Fixed panel for combinations. It can be used in combination with the selected shower enclosure model to create corner or three-sided installations where possible.*



## CONFIGURAZIONI IN ANGOLO ED A TRE LATI CORNER AND THREE-SIDED CONFIGURATIONS

È possibile realizzare configurazioni ad angolo ed a tre lati. Verificare le possibilità nelle pagine dei modelli specifici.

*It is possible to create corner and three-sided configurations; Check the options on the pages of the specific models.*

## ORIENTAMENTO E POSSIBILI COMBINAZIONI / ORIENTATION AND POSSIBLE CONFIGURATIONS

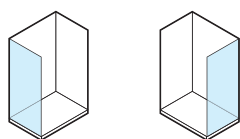

### PROFILI / PROFILES

#### STANDARD

L01 Bianco Lucido  
Glossy White

### VETRO / GLASS

#### STANDARD

TR Trasparente  
Transparent

ST Stampato  
Printed

JU Juta  
Juta

**PARETE FISSA / FIXED PANEL**

L1 [cm]	COD.	A [cm]	B [cm]	C [cm]	[dm <sup>3</sup> ]	[kg]	[Pcs]	V	L01
68-76	B6819	-	-	-	140	15	1	TR	240,00
								ST	250,00
								JU	250,00
77-85	B6820	-	-	-	158	17	1	TR	250,00
								ST	265,00
								JU	265,00
								TR	270,00
86-94	B6821	-	-	-	175	18	1	ST	285,00
								JU	285,00

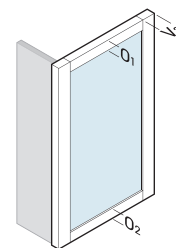

L	
V <sub>2</sub>	50mm
O <sub>1</sub>	35mm
O <sub>2</sub>	35mm

SU MISURA/CUSTOM	PARETE FISSA FIXED PANEL	[€]
↕ Altezza/Height <sup>1</sup>	200cm	+20%
↔ Larghezza/Width <sup>2</sup>	20-120cm	+20%
↕ Altezza/Height ↔ Larghezza/Width <sup>2</sup>	200cm 20-120cm	+20%
Altre forme Other shapes <sup>2</sup>		+30%

OPTIONAL	COD.	[€]
Profilo compensazione Compensation Profile	COM7 (+4cm)	L01 60,00
		ULU 90,00
		SAR 90,00
 StarClean	Parete Fissa/Fixed Panel	50,00
Kit installazione come divisorio Installation kit as a divider	KT6800	Estensibilità ridotta di 2cm Reduced extendability by 2 cm 135,00

**DISPONIBILITA' A MAGAZZINO / STOCK AVAILABILITY**

1/2 Settimane/Weeks +1 StarClean Optional	2/3 Settimane/Weeks	3/4 Settimane/Weeks
--	---------------------	---------------------

<sup>1</sup> Dal prezzo della misura di riferimento / From the price of selected size

<sup>2</sup> Dal prezzo della misura superiore / From the price of the larger size



# FLEX

## PRODOTTI DELLA SERIE / PRODUCTS OF THE SERIES

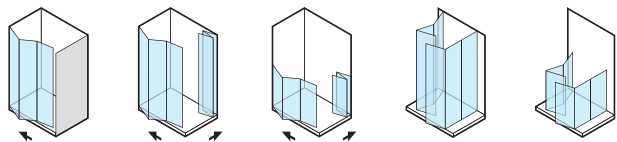

346-347

348-349

350-351

352-353

354-355

## PROFILI / PROFILES

### STANDARD

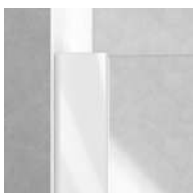

**L01**

Bianco Lucido  
Glossy White

## VETRO / GLASS

### STANDARD



**TR**

Trasparente  
Transparent

**SE**

Setola  
Setola

# FLEX

PORTA SOFFIETTO A TRE ANTE  
THREE-PANEL FOLDING DOOR



Per istruzioni di montaggio  
e ricambi inquadra il codice QR  
For assembly instructions  
and spare parts, scan the QR code



H. 185cm  
SP. 3mm

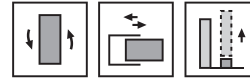

Parete doccia con tre ante con apertura a soffietto. L'apertura delle ante è sia verso l'interno che verso l'esterno. Modello adatto per situazioni che necessitano di un ingresso ampio, ma con spazio di installazione limitato o a target particolari, come ad esempio persone anziane o portatori di handicap.

*Shower wall with three folding panels. The panels open both inward and outward. This model is suitable for situations requiring a wide entry but with limited installation space or for specific target groups, such as elderly people or individuals with disabilities.*

### CONFIGURAZIONE IN NICCHIA NICHE CONFIGURATION

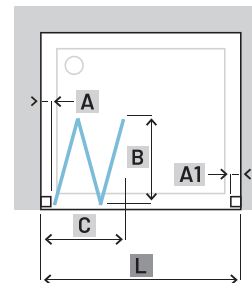

### CONFIGURAZIONI IN ANGOLO E A TRE LATI CORNER AND THREE-SIDED CONFIGURATIONS

Non è possibile realizzare configurazioni in angolo.  
Non è possibile realizzare configurazioni a tre lati.  
*It is not possible to create corner configurations.  
It is not possible to create three-sided configurations.*

### ORIENTAMENTO E POSSIBILI COMBINAZIONI / ORIENTATION AND POSSIBLE CONFIGURATIONS

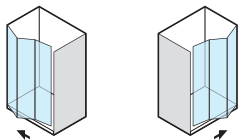

#### PROFILI / PROFILES

STANDARD	
L01	Bianco Lucido Glossy White

#### VETRO / GLASS

STANDARD	
TR	Trasparente Transparent
SE	Setola Setola

## PORTA / DOOR

L [cm]	COD.	A [cm]	A1 [cm]	B [cm]	C INT. [cm]	C EST. [cm]	[dm3]	[kg]	[Pcs]	V	L01
63-67	B3512	5-7	4-6	23,5	9,5-11	10-12	63	17	1	TR	415,00
								11	1	SE	415,00
67-71	B3513	5-7	4-6	24,5	9,5-11	10-12	67	17	1	TR	425,00
								12	1	SE	425,00
71-75	B3514	5-7	4-6	26	9,5-11	10-12	70	18	1	TR	435,00
								12	1	SE	435,00
75-79	B3515	5-7	4-6	27,5	9,5-11	10-12	74	19	1	TR	440,00
								13	1	SE	440,00
79-83	B3516	5-7	4-6	28,5	9,5-11	10-12	78	19	1	TR	450,00
								13	1	SE	450,00
83-87	B3517	5-7	4-6	30	9,5-11	10-12	81	20	1	TR	460,00
								13	1	SE	460,00
87-91	B3518	5-7	4-6	31	9,5-11	10-12	94	20	1	TR	465,00
								14	1	SE	465,00



L	V1	V2
	30mm	
		50mm

**!** La parete doccia Flex viene fornita senza i profili di chiusura superiore ed inferiore. È possibile fare richiesta dei profili come optional aggiuntivi. Vedere tabella degli optional per maggiori informazioni. I profili vengono forniti nella lunghezza massima e si potranno tagliare a misura corretta durante l'installazione. Le misure C INT. e C EST. si riferiscono all'ingombro del pacchetto porta completamente accorpato e rispettivamente orientato all'interno (C INT.) o all'esterno (C EST.) della parete doccia.

The Flex shower enclosure is supplied without the upper and lower sealing profiles. These profiles can be requested as additional optional items. See the optional items table for more information. The profiles are provided in maximum length and can be cut to the correct size during installation. The measurements C INT. and C EST. refer to the space occupied by the fully folded door package, oriented respectively towards the inside (C INT.) or the outside (C EST.) of the shower enclosure.

## PROFILI DI BATTUTA / CLOSING PROFILES

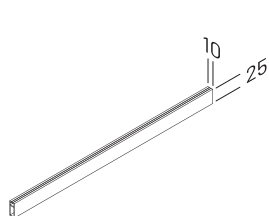

C0118 91cm  
C0158 120cm

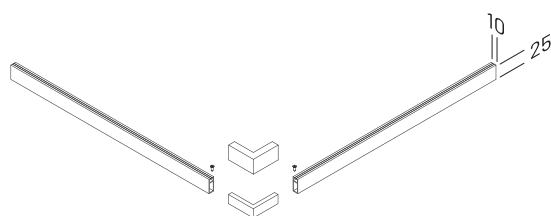

C0128 92\*92cm  
C0168 120\*120cm

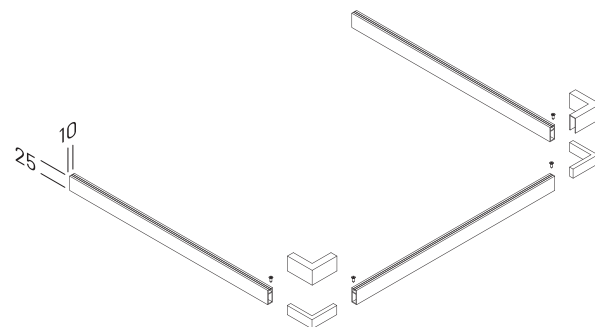

C0138 91\*91\*91cm  
C0148 120\*120\*120cm

SU MISURA/CUSTOM	PORTA TR DOOR TR	PORTA SE DOOR SE	[€]
Altezza/Height <sup>1</sup>	100-200cm	100-200cm	+20%
Larghezza/Width <sup>2</sup>	46-109cm	46-120cm	+20%
Altezza/Height Larghezza/Width <sup>2</sup>	100-200cm 46-109cm	100-200cm 46-120cm	+20%
Altre forme Other shapes <sup>2</sup>			+30%

OPTIONAL	COD.	[€]
Profilo di battuta (1 pezzo) Closing Profile (1 piece)	C0118 91cm L01	40,00
	C0158 120cm L01	50,00

<sup>1</sup> Dal prezzo della misura di riferimento/From the price of selected size

<sup>2</sup> Dal prezzo della misura superiore/From the price of the larger size

### DISPONIBILITÀ A MAGAZZINO / STOCK AVAILABILITY

1/2 Settimane/Weeks    2/3 Settimane/Weeks    3/4 Settimane/Weeks

# FLEX

PORTA SOFFIETTO A TRE ANTE + PORTA SOFFIETTO A TRE ANTE  
THREE-PANEL FOLDING DOOR + THREE-PANEL FOLDING DOOR



Per istruzioni di montaggio  
e ricambi inquadra il codice QR  
For assembly instructions  
and spare parts, scan the QR code



H. 185cm  
SP. 3mm



Parete doccia in configurazione ad angolo con doppia porta a soffietto sezionata in tre ante. L'apertura delle ante è sia verso l'interno che verso l'esterno. Modello adatto per situazioni che necessitano di un ingresso ampio, ma con spazio di installazione limitato o a target particolari, come ad esempio persone anziane o portatori di handicap.

Shower enclosure in a corner configuration with a double folding door divided into three panels. The panels open both inward and outward. This model is suitable for situations requiring a wide entry but with limited installation space or for specific target groups, such as elderly people or individuals with disabilities.

CONFIGURAZIONE IN ANGOLO  
CORNER CONFIGURATION

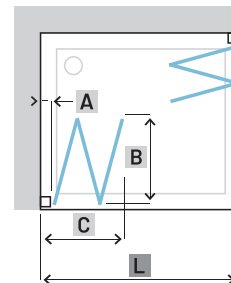

! CONFIGURAZIONI IN NICCHIA E A TRE LATI  
NICHE AND THREE-SIDED CONFIGURATIONS

Non è possibile realizzare configurazioni in nicchia.  
Non è possibile realizzare configurazioni a tre lati.  
It is not possible to create niche configurations.  
It is not possible to create three-sided configurations.

## ORIENTAMENTO E POSSIBILI COMBINAZIONI / ORIENTATION AND POSSIBLE CONFIGURATIONS

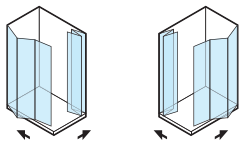

### PROFILI / PROFILES

#### STANDARD

L01 Bianco Lucido  
Glossy White

### VETRO / GLASS

#### STANDARD

TR Trasparente  
Transparent

SE Setola  
Setola

## PORTA / DOOR

L [cm]	COD.	A [cm]	B [cm]	C INT. [cm]	C EST. [cm]	[dm3]	[kg]	[Pcs]	V	L01
64-68	B3522	7-11	22,5	9,5-13,5	9,5-13,5	94	28	1	TR	740,00
							22	1	SE	740,00
68-72	B3523	7-11	25	9,5-13,5	9,5-13,5	101	29	1	TR	750,00
							22	1	SE	750,00
72-76	B3524	7-11	25,5	9,5-13,5	9,5-13,5	103	30	1	TR	760,00
							22	1	SE	760,00
76-80	B3525	7-11	27	9,5-13,5	9,5-13,5	109	32	1	TR	775,00
							23	1	SE	775,00
80-84	B3526	7-11	29	9,5-13,5	9,5-13,5	114	33	1	TR	790,00
							23	1	SE	790,00
84-88	B3527	7-11	30	9,5-13,5	9,5-13,5	120	34	1	TR	800,00
							24	1	SE	800,00
88-92	B3528	7-11	31	9,5-13,5	9,5-13,5	126	35	1	TR	810,00
							25	1	SE	810,00
68-72/88-92	B3543	7-11	25/31	9,5-13,5	9,5-13,5	126	37	1	TR	785,00
							26	1	SE	785,00
72-76/88-92	B3544	7-11	25,5-31	9,5-13,5	9,5-13,5	126	38	1	TR	790,00
							26	1	SE	790,00



L	V1	V2
	30mm	
		50mm

! La parete doccia Flex viene fornita senza i profili di chiusura superiore ed inferiore. È possibile fare richiesta dei profili come optional aggiuntivi. Vedere tabella degli optional per maggiori informazioni. I profili vengono forniti nella lunghezza massima e si potranno tagliare a misura corretta durante l'installazione.

Le misure C INT. e C EST. si riferiscono all'ingombro del pacchetto porta completamente accorpato e rispettivamente orientato all'interno (C INT.) o all'esterno (C EST.) della parete doccia.

The Flex shower enclosure is supplied without the upper and lower sealing profiles. These profiles can be requested as additional optional items. See the optional items table for more information. The profiles are provided in maximum length and can be cut to the correct size during installation. The measurements C INT. and C EST. refer to the space occupied by the fully folded door package, oriented respectively towards the inside (C INT.) or the outside (C EST.) of the shower enclosure.

## PROFILI DI BATTUTA / CLOSING PROFILES

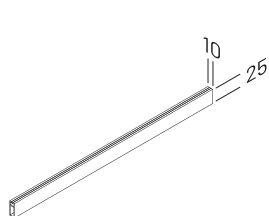

C0118 91cm  
C0158 120cm

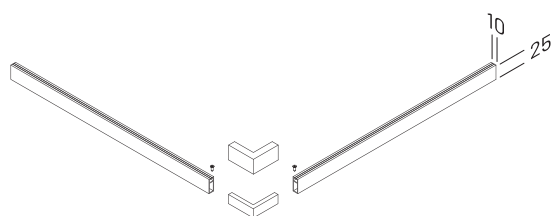

C0128 92\*92cm  
C0168 120\*120cm

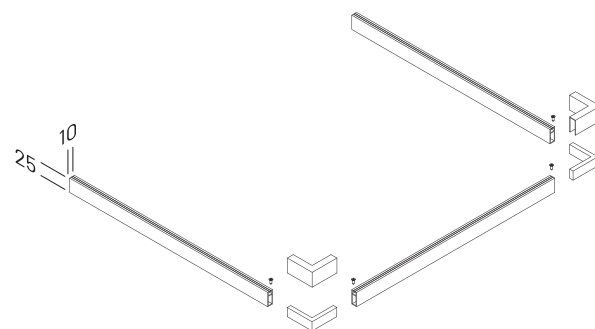

C0138 91\*91\*91cm  
C0148 120\*120\*120cm

SU MISURA/CUSTOM	PORTA TR DOOR TR	PORTA SE DOOR SE	[€]
Altezza/Height <sup>1</sup>	100-200cm	100-200cm	+20%
Larghezza/Width <sup>2</sup>	46-92cm	46-120cm	+20%
Altezza/Height Larghezza/Width <sup>2</sup>	100-200cm 46-92cm	100-200cm 46-120cm	+20%
Altre forme Other shapes <sup>2</sup>			+30%

OPTIONAL	COD.	[€]
Profilo di battuta (1 pezzo) Closing Profile (1 piece)	C0128 92*92cm	L01 50,00
	C0168 120*120cm	L01 65,00

<sup>1</sup> Dal prezzo della misura di riferimento/From the price of selected size

<sup>2</sup> Dal prezzo della misura superiore/From the price of the larger size

DISPONIBILITÀ A MAGAZZINO / STOCK AVAILABILITY

1/2 Settimane/Weeks 2/3 Settimane/Weeks 3/4 Settimane/Weeks

# FLEX

PORTA SOFFIETTO A TRE ANTE + PORTA SOFFIETTO A TRE ANTE  
THREE-PANEL FOLDING DOOR + THREE-PANEL FOLDING DOOR



Per istruzioni di montaggio  
e ricambi inquadra il codice QR  
For assembly instructions  
and spare parts, scan the QR code



H. 100cm  
SP. 3mm



Parete doccia in configurazione ad angolo con doppia porta a soffietto sezionata in tre ante. L'apertura delle ante è sia verso l'interno che verso l'esterno. Modello adatto per situazioni che necessitano di un ingresso ampio, ma con spazio di installazione limitato o a target particolari, come ad esempio persone anziane o portatori di handicap.

Shower enclosure in a corner configuration with a double folding door divided into three panels. The panels open both inward and outward. This model is suitable for situations requiring a wide entry but with limited installation space or for specific target groups, such as elderly people or individuals with disabilities.

### CONFIGURAZIONE IN ANGOLO CORNER CONFIGURATION

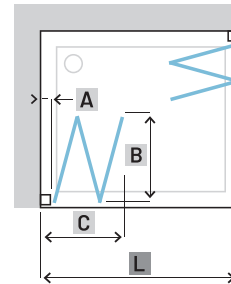

### CONFIGURAZIONI IN NICCHIA E A TRE LATI NICHE AND THREE-SIDED CONFIGURATIONS

Non è possibile realizzare configurazioni in nicchia.  
Non è possibile realizzare configurazioni a tre lati.  
It is not possible to create niche configurations.  
It is not possible to create three-sided configurations.

### ORIENTAMENTO E POSSIBILI COMBINAZIONI / ORIENTATION AND POSSIBLE CONFIGURATIONS

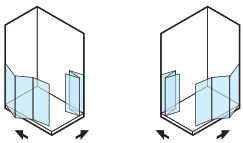

#### PROFILI / PROFILES

##### STANDARD

L01 Bianco Lucido  
Glossy White

#### VETRO / GLASS

##### STANDARD

SE Setola  
Setola

## PORTA / DOOR

L [cm]	COD.	A [cm]	B [cm]	C INT. [cm]	C EST. [cm]	[dm <sup>3</sup> ]	[kg]	[Pcs]	V	L01
76-80	<b>B3625</b>	7-11	27	9,5-13,5	9,5-13,5	51	12	1	SE	485,00
88-92	<b>B3628</b>	7-11	31	9,5-13,5	9,5-13,5	59	14	1	SE	495,00

! La parete doccia Flex viene fornita senza i profili di chiusura superiore ed inferiore. È possibile fare richiesta dei profili come optional aggiuntivi. Vedere tabella degli optional per maggiori informazioni. I profili vengono forniti nella lunghezza massima e si potranno tagliare a misura corretta durante l'installazione.

Le misure C INT. e C EST. si riferiscono all'ingombro del pacchetto porta completamente accorciato e rispettivamente orientato all'interno (C INT.) o all'esterno (C EST.) della parete doccia.

The Flex shower enclosure is supplied without the upper and lower sealing profiles. These profiles can be requested as additional optional items. See the optional items table for more information. The profiles are provided in maximum length and can be cut to the correct size during installation.

The measurements C INT. and C EST. refer to the space occupied by the fully folded door package, oriented respectively towards the inside (C INT.) or the outside (C EST.) of the shower enclosure.



L	
V <sub>1</sub>	30mm
V <sub>2</sub>	50mm

## PROFILI DI BATTUTA / CLOSING PROFILES

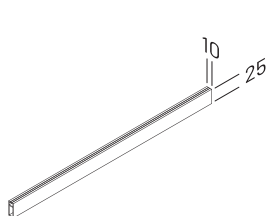

**C0118** 91cm  
**C0158** 120cm

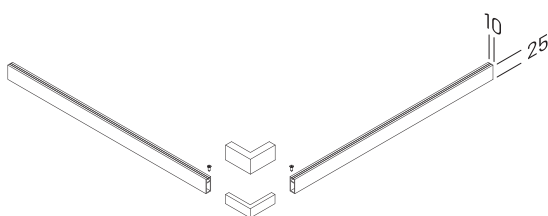

**C0128** 92\*92cm  
**C0168** 120\*120cm

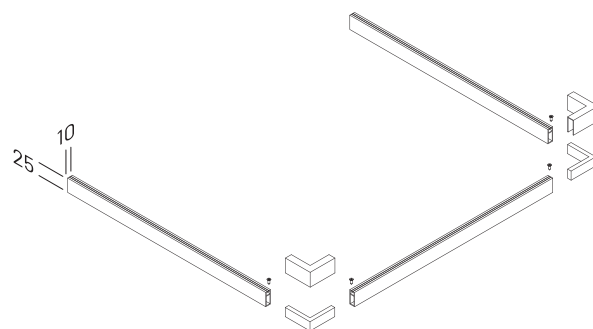

**C0138** 91\*91\*91cm  
**C0148** 120\*120\*120cm

SU MISURA/CUSTOM	PORTA DOOR	[€]
Altezza/Height <sup>1</sup>	-	-
Larghezza/Width <sup>2</sup>	46-120cm	+20%
Altezza/Height Larghezza/Width <sup>2</sup>	-	-
Altre forme Other shapes <sup>2</sup>		+30%

OPTIONAL	COD.	[€]
Profilo di battuta (1 pezzo) Closing Profile (1 piece)	<b>C0128</b> 92*92cm <b>C0168</b> 120*120cm	L01 50,00 L01 65,00

<sup>1</sup> Dal prezzo della misura di riferimento/From the price of selected size

<sup>2</sup> Dal prezzo della misura superiore/From the price of the larger size

### DISPONIBILITA' A MAGAZZINO / STOCK AVAILABILITY

1/2 Settimane/Weeks    2/3 Settimane/Weeks    3/4 Settimane/Weeks

# FLEX

## PENISOLA SOFFIETTO A TRE ANTE THREE-DOOR BELLOWS PENINSULA



Per istruzioni di montaggio  
e ricambi inquadra il codice QR  
For assembly instructions  
and spare parts, scan the QR code



**H. 185cm**  
**SP. 3mm**



Parete doccia in configurazione a tre lati con doppia porta a soffietto sezionata in tre ante. L'apertura delle ante permette un accesso completo. Modello adatto per situazioni che necessitano di un ingresso ampio, ma con spazio di installazione limitato o a target particolari, come ad esempio persone anziane o portatori di handicap.

*Three-sided shower wall configuration with a double folding door divided into three panels. The panel opening allows full access. This model is suitable for situations requiring a wide entry but with limited installation space or for specific target groups, such as elderly people or individuals with disabilities.*

### CONFIGURAZIONE A TRE LATI THREE-SIDED CONFIGURATION

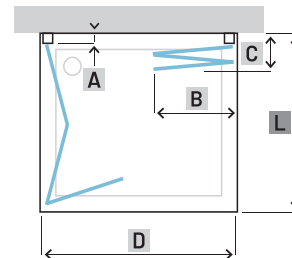

### ! CONFIGURAZIONI IN NICCHIA E AD ANGOLO NICHE AND THREE-SIDED CONFIGURATIONS

Non è possibile realizzare configurazioni in nicchia.  
Non è possibile realizzare configurazioni ad angolo.  
*It is not possible to create niche configurations.  
It is not possible to create corner configurations.*

### ORIENTAMENTO E POSSIBILI COMBINAZIONI / ORIENTATION AND POSSIBLE CONFIGURATIONS

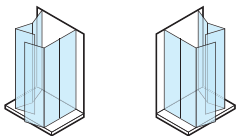

#### PROFILI / PROFILES

##### STANDARD

**L01** Bianco Lucido  
Glossy White

#### VETRO / GLASS

##### STANDARD

**TR** Trasparente  
Transparent

**SE** Setola  
Setola

## PORTA / DOOR

L [cm]	COD.	A [cm]	B [cm]	C INT. [cm]	C EST. [cm]	D [cm]	[dm <sup>3</sup> ]	[kg]	[Pcs]	V	L01
63-67	B3532	7-11	34,5	10-14	9,5-13,5	65	127	39	1	TR	880,00
								31	1	SE	880,00
67-71	B3533	7-11	37	10-14	9,5-13,5	70	137	40	1	TR	900,00
								32	1	SE	900,00
71-75	B3534	7-11	39,5	10-14	9,5-13,5	75	144	41	1	TR	915,00
								33	1	SE	915,00
75-79	B3535	7-11	40,5	10-14	9,5-13,5	77	150	42	1	TR	930,00
								34	1	SE	930,00
79-83	B3536	7-11	42	10-14	9,5-13,5	80	161	43	1	TR	945,00
								35	1	SE	945,00
83-87	B3537	7-11	44,5	10-14	9,5-13,5	85	165	44	1	TR	965,00
								36	1	SE	965,00
87-91	B3538	7-11	47	10-14	9,5-13,5	90	174	45	1	TR	985,00
								37	1	SE	985,00



L	V1	V2
	30mm	
		50mm

**!** La parete doccia Flex viene fornita senza i profili di chiusura superiore ed inferiore. È possibile fare richiesta dei profili come optional aggiuntivi. Vedere tabella degli optional per maggiori informazioni. I profili vengono forniti nella lunghezza massima e si potranno tagliare a misura corretta durante l'installazione. Le misure C INT. e C EST. si riferiscono all'ingombro del pacchetto porta completamente accorpato e rispettivamente orientato all'interno (C INT.) o all'esterno (C EST.) della parete doccia.

The Flex shower enclosure is supplied without the upper and lower sealing profiles. These profiles can be requested as additional optional items. See the optional items table for more information. The profiles are provided in maximum length and can be cut to the correct size during installation. The measurements C INT. and C EST. refer to the space occupied by the fully folded door package, oriented respectively towards the inside (C INT.) or the outside (C EST.) of the shower enclosure.

## PROFILI DI BATTUTA / CLOSING PROFILES

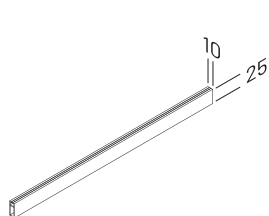

C0118 91cm  
C0158 120cm

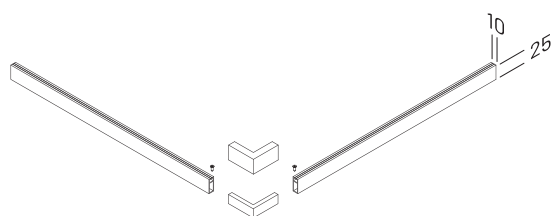

C0128 92\*92cm  
C0168 120\*120cm

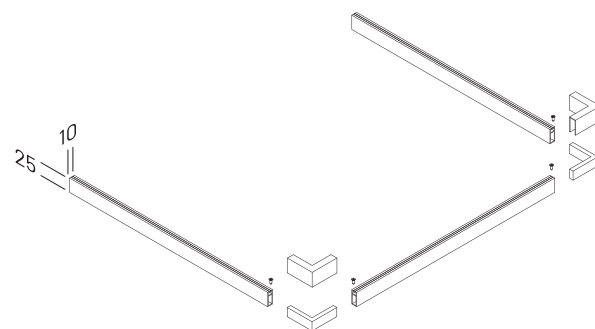

C0138 91\*91\*91cm  
C0148 120\*120\*120cm

SU MISURA/CUSTOM	PORTA TR DOOR TR	PORTA SE DOOR SE	[€]
Altezza/Height <sup>1</sup>	100-200cm	100-200cm	+20%
Larghezza/Width <sup>2</sup>	46-109cm	46-120cm	+20%
Altezza/Height Larghezza/Width <sup>2</sup>	100-200cm 46-109cm	100-200cm 46-120cm	+20%
Altre forme Other shapes <sup>2</sup>			+30%

OPTIONAL	COD.	[€]
Profilo di battuta (1 pezzo) Closing Profile (1 piece)	C0138 91*91*91cm C0148 120*120*120cm	L01 65,00 L01 75,00

<sup>1</sup> Dal prezzo della misura di riferimento/From the price of selected size

<sup>2</sup> Dal prezzo della misura superiore/From the price of the larger size

## DISPONIBILITÀ A MAGAZZINO / STOCK AVAILABILITY

1/2 Settimane/Weeks    2/3 Settimane/Weeks    3/4 Settimane/Weeks

# FLEX

## PENISOLA SOFFIETTO A TRE ANTE THREE-DOOR BELLOWS PENINSULA



Per istruzioni di montaggio  
e ricambi inquadra il codice QR  
For assembly instructions  
and spare parts, scan the QR code



**H. 100cm**  
**SP. 3mm**



Parete doccia in configurazione a tre lati con doppia porta a soffietto sezionata in tre ante. L'apertura delle ante permette un accesso completo. Modello adatto per situazioni che necessitano di un ingresso ampio, ma con spazio di installazione limitato o a target particolari, come ad esempio persone anziane o portatori di handicap.

*Three-sided shower wall configuration with a double folding door divided into three panels. The panel opening allows full access. This model is suitable for situations requiring a wide entry but with limited installation space or for specific target groups, such as elderly people or individuals with disabilities.*

### CONFIGURAZIONE A TRE LATI THREE-SIDED CONFIGURATION

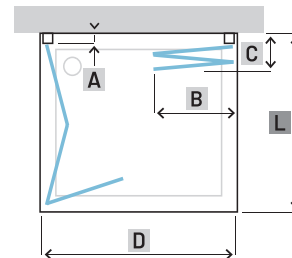

### CONFIGURAZIONI IN NICCHIA E AD ANGOLO NICHE AND THREE-SIDED CONFIGURATIONS

Non è possibile realizzare configurazioni in nicchia.  
Non è possibile realizzare configurazioni ad angolo.  
*It is not possible to create niche configurations.  
It is not possible to create corner configurations.*

### ORIENTAMENTO E POSSIBILI COMBINAZIONI / ORIENTATION AND POSSIBLE CONFIGURATIONS

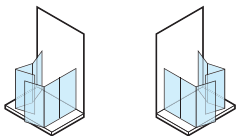

#### PROFILI / PROFILES

##### STANDARD

**L01** Bianco Lucido  
Glossy White

#### VETRO / GLASS

##### STANDARD

**SE** Setola  
Setola

## PORTA / DOOR

L [cm]	COD.	A [cm]	B [cm]	C INT. [cm]	C EST. [cm]	D [cm]	[dm <sup>3</sup> ]	[kg]	[Pcs]	V	L01
79-83	<b>B3636</b>	7-11	42	10-14	9,5-13,5	80	63	15	1	SE	635,00
87-91	<b>B3638</b>	7-11	47	10-14	9,5-13,5	90	70	18	1	SE	650,00

**!** La parete doccia Flex viene fornita senza i profili di chiusura superiore ed inferiore. È possibile fare richiesta dei profili come optional aggiuntivi. Vedere tabella degli optional per maggiori informazioni. I profili vengono forniti nella lunghezza massima e si potranno tagliare a misura corretta durante l'installazione. Le misure C INT. e C EST. si riferiscono all'ingombro del pacchetto porta completamente accorpato e rispettivamente orientato all'interno (C INT.) o all'esterno (C EST.) della parete doccia.

*The Flex shower enclosure is supplied without the upper and lower sealing profiles. These profiles can be requested as additional optional items. See the optional items table for more information. The profiles are provided in maximum length and can be cut to the correct size during installation. The measurements C INT. and C EST. refer to the space occupied by the fully folded door package, oriented respectively towards the inside (C INT.) or the outside (C EST.) of the shower enclosure.*



L	
V <sub>1</sub>	30mm
V <sub>2</sub>	50mm

## PROFILI DI BATTUTA / CLOSING PROFILES

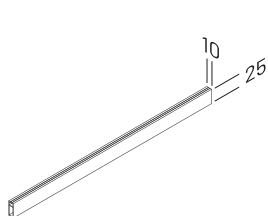

**C0118** 91cm  
**C0158** 120cm

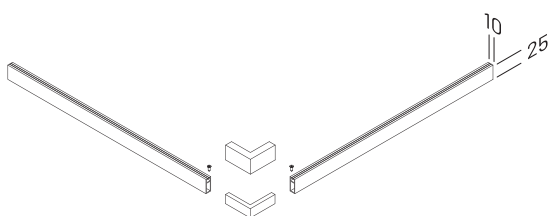

**C0128** 92\*92cm  
**C0168** 120\*120cm

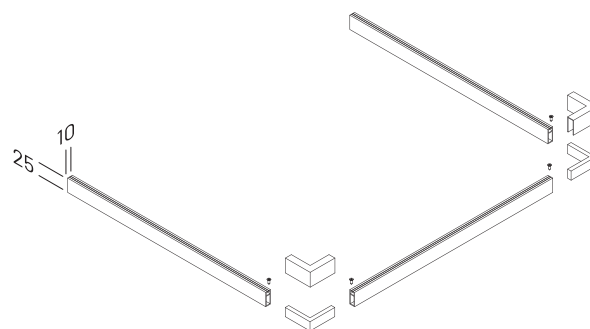

**C0138** 91\*91\*91cm  
**C0148** 120\*120\*120cm

SU MISURA/CUSTOM	PORTA DOOR	[€]
↕ Altezza/Height <sup>1</sup>	-	-
↔ Larghezza/Width <sup>2</sup>	46-120cm	+20%
↕↔ Altezza/Height Larghezza/Width <sup>2</sup>	-	-
Altre forme Other shapes <sup>2</sup>		+30%

OPTIONAL	COD.		[€]
Profilo di battuta (1 pezzo) Closing Profile (1 piece)	<b>C0138</b>	91*91*91cm	L01 65,00
	<b>C0148</b>	120*120*120cm	L01 75,00

<sup>1</sup> Dal prezzo della misura di riferimento/From the price of selected size

<sup>2</sup> Dal prezzo della misura superiore/From the price of the larger size

### DISPONIBILITÀ A MAGAZZINO / STOCK AVAILABILITY

**1/2** Settimane/Weeks    **2/3** Settimane/Weeks    **3/4** Settimane/Weeks



# CIAO

## PRODOTTI DELLA SERIE / PRODUCTS OF THE SERIES

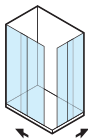

358-359

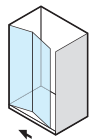

360-361

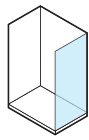

362-363

## PROFILI / PROFILES

### STANDARD



### L01

Bianco Lucido  
Glossy White

## VETRO / GLASS

### STANDARD



### TR

Trasparente  
Transparent



### ST

Stampato  
Printed



### SE

Setola  
Setola

# CIAO

## ANGOLO DUE PORTE SCORREVOLI COMPLETO COMPLETE CORNER TWO SLIDING DOORS



Per istruzioni di montaggio  
e ricambi inquadra il codice QR  
For assembly instructions  
and spare parts, scan the QR code



**H. 185cm**  
**SP. 3mm**

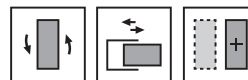

Parete doccia ad angolo a quattro ante, apertura ad ante scorrevoli nell'angolo del prodotto. Modello adatto per la maggior parte delle installazioni e disponibile in un'ampia gamma di dimensioni, soprattutto per chi vuole massimizzare le dimensioni d'ingresso.

*Corner shower wall with four panels, featuring sliding doors at the corner of the product. Suitable for most installations and available in a wide range of sizes, especially for those looking to maximize the entry dimensions.*

### CONFIGURAZIONE AD ANGOLO CORNER CONFIGURATION

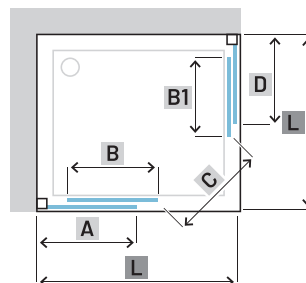

### CONFIGURAZIONI A TRE LATI THREE-SIDED CONFIGURATIONS

Per configurazioni a tre lati utilizzare la parete fissa standard Ciao nella pagina seguente.

*For three-sided configurations, use the standard Ciao fixed panel on the following page.*

### ORIENTAMENTO E POSSIBILI COMBINAZIONI / ORIENTATION AND POSSIBLE CONFIGURATIONS

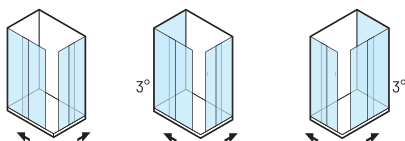

#### PROFILI / PROFILES

##### STANDARD

**L01** Bianco Lucido  
Glossy White

#### VETRO / GLASS

##### STANDARD

**TR** Trasparente  
Transparent

**ST** Stampato  
Printed Glass

**SE** Setola  
Setola

## PORTA / DOOR

L [cm]	COD.	A [cm]	B [cm]	B1 [cm]	C [cm]	D [cm]	[dm <sup>3</sup> ]	[kg]	[Pcs]	V	L01
64-74	B2601	37,5-39,5	36,4		30-44		122	27	1	TR	380,00
										ST	400,00
								13	1	SE	345,00
70-80	B2602	40,5-42,5	39,4		34-48		136	29	1	TR	400,00
										ST	420,00
								14	1	SE	365,00
80-90	B2603	45,5-47,5	44,4		42-56		153	30	1	TR	415,00
										ST	435,00
								14	1	SE	375,00
64-74 80-90	B2610	37,5-39,5	36,4		37-51		156	31	1	TR	395,00
									ST	415,00	
14								1	SE	360,00	

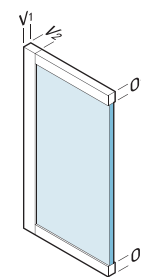

L	V1	V2	O1	O2
	28mm	36mm	35mm	35mm

## PARETE FISSA / FIXED PANEL

H. 185cm  
SP. 3mm

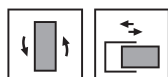

L1 [cm]	COD.	A [cm]	B [cm]	B1 [cm]	C [cm]	D [cm]	[dm <sup>3</sup> ]	[kg]	[Pcs]	V	L01
65-69	B2670	-	-	-	-	-	97	12	1	TR	200,00
										ST	210,00
								7	1	SE	190,00
69-73	B2671	-	-	-	-	-	99	13	1	TR	205,00
										ST	215,00
								8	1	SE	195,00
73-77	B2672	-	-	-	-	-	102	14	1	TR	210,00
										ST	220,00
								9	1	SE	200,00
77-81	B2673	-	-	-	-	-	107	15	1	TR	210,00
										ST	220,00
								9	1	SE	205,00
81-85	B2674	-	-	-	-	-	112	16	1	TR	215,00
										ST	225,00
								9	1	SE	210,00
85-89	B2675	-	-	-	-	-	118	17	1	TR	220,00
										ST	230,00
								10	1	SE	215,00
89-93	B2676	-	-	-	-	-	123	18	1	TR	225,00
										ST	235,00
								10	1	SE	220,00

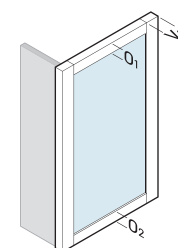

L1	V2	O1	O2
	36mm	35mm	35mm

SU MISURA/CUSTOM	PORTA DOOR	[€]	PARETE TR/ST WALL TR/ST	PARETE SE WALL SE	[€]
Altezza/Height <sup>1</sup>	185cm	+20%	185cm	185cm	+20%
Larghezza/Width <sup>2</sup>	60-100cm	+20%	20-120cm	20-100cm	+20%
Altezza/Height Larghezza/Width <sup>2</sup>	185cm 60-100cm	+20%	185cm 20-120cm	185cm 20-100cm	+20%
Altre forme Other shapes <sup>2</sup>		+30%			+30%

DISPONIBILITA' A MAGAZZINO / STOCK AVAILABILITY

1/2 Settimane/Weeks

2/3 Settimane/Weeks

3/4 Settimane/Weeks

<sup>1</sup> Dal prezzo della misura di riferimento/From the price of selected size

<sup>2</sup> Dal prezzo della misura superiore/From the price of the larger size

# CIAO

PORTA SOFFIETTO  
FOLDING DOOR



Per istruzioni di montaggio  
e ricambi inquadra il codice QR  
For assembly instructions  
and spare parts, scan the QR code



H. 185cm  
SP. 3mm



Parete doccia con due ante con apertura a soffietto. L'apertura delle ante è verso l'interno. Modello adatto per situazioni che necessitano di un ingresso ampio, ma con spazio di installazione limitato.

Shower enclosure with two folding doors. The doors open inward. This model is suitable for situations requiring a wide entrance, but with limited installation space.

CONFIGURAZIONE IN NICCHIA  
NICHE CONFIGURATION

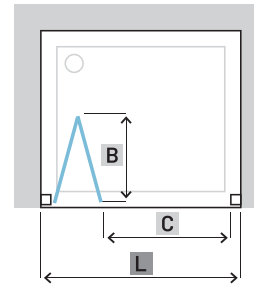

CONFIGURAZIONE AD ANGOLO  
CORNER CONFIGURATION

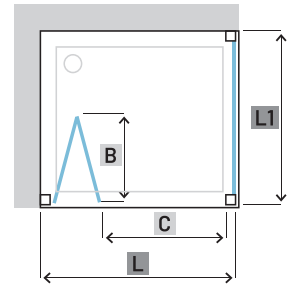

CONFIGURAZIONI A TRE LATI  
THREE-SIDED CONFIGURATIONS

Per configurazioni a tre lati utilizzare la parete fissa standard Ciao nella pagina seguente.

For three-sided configurations, use the standard Ciao fixed panel on the following page.

## ORIENTAMENTO E POSSIBILI COMBINAZIONI / ORIENTATION AND POSSIBLE CONFIGURATIONS

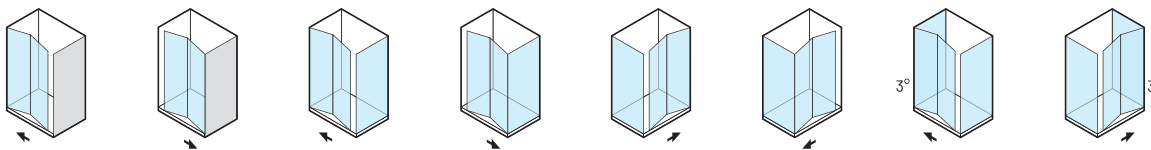

### PROFILI / PROFILES

#### STANDARD

L01 Bianco Lucido  
Glossy White

### VETRO / GLASS

#### STANDARD

TR Trasparente  
Transparent

ST Stampato  
Printed Glass

SE Setola  
Setola

## PORTA / DOOR

L [cm]	COD.	A [cm]	B [cm]	C [cm]	[dm <sup>3</sup> ]	[kg]	[Pcs]	V	L01
69-73	B2660	14-16	34	51	98	17	1	TR	350,00
								ST	370,00
								SE	335,00
73-77	B2661	14-16	36	55	103	18	1	TR	355,00
								ST	375,00
								SE	340,00
77-81	B2662	14-16	38	59	108	18	1	TR	360,00
								ST	380,00
								SE	345,00
81-85	B2663	14-16	40	63	114	19	1	TR	370,00
								ST	390,00
								SE	350,00
85-89	B2664	14-16	42	67	119	19	1	TR	375,00
								ST	395,00
								SE	355,00
89-93	B2665	14-16	44	71	125	20	1	TR	380,00
								ST	400,00
								SE	360,00
93-97	B2666	14-16	46	75	130	21	1	TR	385,00
								ST	405,00
								SE	365,00
97-101	B2667	14-16	48	79	135	22	1	TR	390,00
								ST	410,00
								SE	370,00

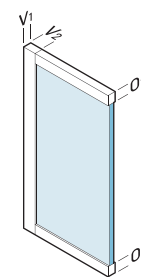

L
V <sub>1</sub> 28mm
V <sub>2</sub> 36mm
O <sub>1</sub> 35mm
O <sub>2</sub> 35mm

## PARETE FISSA / FIXED PANEL

H. 185cm  
SP. 3mm

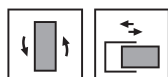

L1 [cm]	COD.	A [cm]	B [cm]	C [cm]	[dm <sup>3</sup> ]	[kg]	[Pcs]	V	L01
65-69	B2670	-	-	-	97	12	1	TR	200,00
								ST	210,00
								SE	190,00
69-73	B2671	-	-	-	99	13	1	TR	205,00
								ST	215,00
								SE	195,00
73-77	B2672	-	-	-	102	14	1	TR	210,00
								ST	220,00
								SE	200,00
77-81	B2673	-	-	-	107	15	1	TR	210,00
								ST	220,00
								SE	205,00
81-85	B2674	-	-	-	112	16	1	TR	215,00
								ST	225,00
								SE	210,00
85-89	B2675	-	-	-	118	17	1	TR	220,00
								ST	230,00
								SE	215,00
89-93	B2676	-	-	-	123	18	1	TR	225,00
								ST	235,00
								SE	220,00

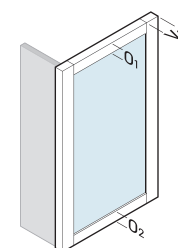

L1
V <sub>2</sub> 36mm
O <sub>1</sub> 35mm
O <sub>2</sub> 35mm

SU MISURA/CUSTOM	PORTA DOOR	[€]	PARETE TR/ST WALL TR/ST	PARETE SE WALL SE	[€]
▲▼ Altezza/Height <sup>1</sup>	185cm	+20%	185cm	185cm	+20%
◀▶ Larghezza/Width <sup>2</sup>	50-110cm	+20%	20-120cm	20-100cm	+20%
◆ Altezza/Height	185cm	+20%	185cm	185cm	+20%
◆ Larghezza/Width <sup>2</sup>	50-110cm	+20%	20-120cm	20-100cm	+20%
Altre forme Other shapes <sup>2</sup>		+30%			+30%

DISPONIBILITA' A MAGAZZINO / STOCK AVAILABILITY

1/2 Settimane/Weeks

2/3 Settimane/Weeks

3/4 Settimane/Weeks

<sup>1</sup> Dal prezzo della misura di riferimento/From the price of selected size

<sup>2</sup> Dal prezzo della misura superiore/From the price of the larger size

# CIAO

## PARETE FISSA FIXED PANEL



Per istruzioni di montaggio  
e ricambi inquadra il codice QR  
For assembly instructions  
and spare parts, scan the QR code



**H. 185cm**  
**SP. 3mm**



Parete fissa per abbinamenti. È possibile utilizzarla in abbinamento al modello di parete doccia selezionato per realizzare installazioni ad angolo o a tre lati quando possibile.

*Fixed panel for combinations. It can be used in combination with the selected shower enclosure model to create corner or three-sided installations where possible.*

### CONFIGURAZIONI IN ANGOLO ED A TRE LATI CORNER AND THREE-SIDED CONFIGURATIONS

È possibile realizzare configurazioni ad angolo ed a tre lati. Verificare le possibilità nelle pagine dei modelli specifici.

*It is possible to create corner and three-sided configurations; Check the options on the pages of the specific models.*

## ORIENTAMENTO E POSSIBILI COMBINAZIONI / ORIENTATION AND POSSIBLE CONFIGURATIONS

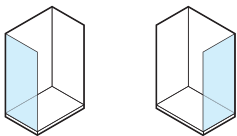

### PROFILI / PROFILES

STANDARD	
L01	Bianco Lucido Glossy White

### VETRO / GLASS

STANDARD	
TR	Trasparente Transparent
ST	Stampato Printed Glass
SE	Setola Setola

**PARETE FISSA/FIXED PANEL**

L1 [cm]	COD.	A [cm]	B [cm]	C [cm]	[dm3]	[kg]	[Pcs]	V	L01
65-69	B2670	-	-	-	97	12	1	TR	200,00
								ST	210,00
								SE	190,00
69-73	B2671	-	-	-	99	13	1	TR	205,00
								ST	215,00
								SE	195,00
73-77	B2672	-	-	-	102	14	1	TR	210,00
								ST	220,00
								SE	200,00
77-81	B2673	-	-	-	107	15	1	TR	210,00
								ST	220,00
								SE	205,00
81-85	B2674	-	-	-	112	16	1	TR	215,00
								ST	225,00
								SE	210,00
85-89	B2675	-	-	-	118	17	1	TR	220,00
								ST	230,00
								SE	215,00
89-93	B2676	-	-	-	123	18	1	TR	225,00
								ST	235,00
								SE	220,00

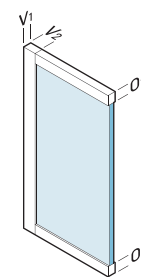

L	
V <sub>2</sub>	36mm
O <sub>1</sub>	35mm
O <sub>2</sub>	35mm

SU MISURA/CUSTOM	PARETE FISSA TR/ST FIXED PANEL TR/ST	[€]	PARETE FISSA SE FIXED PANEL SE	[€]
↕ Altezza/Height <sup>1</sup>	185cm	+20%	185cm	+20%
↔ Larghezza/Width <sup>2</sup>	20-120cm	+20%	20-100cm	+20%
↕ Altezza/Height ↔ Larghezza/Width <sup>2</sup>	185cm 20-120cm	+20%	185cm 20-100cm	+20%
Altre forme Other shapes <sup>2</sup>		+30%		+30%

OPTIONAL	COD.	[€]
Kit installazione come divisorio Installation kit as a divider	KT2600	Estensibilità ridotta di 2cm Reduced extendability by 2 cm
		95,00

<sup>1</sup> Dal prezzo della misura di riferimento/From the price of selected size

<sup>2</sup> Dal prezzo della misura superiore/From the price of the larger size

DISPONIBILITA' A MAGAZZINO / STOCK AVAILABILITY

1/2 Settimane/Weeks

2/3 Settimane/Weeks

3/4 Settimane/Weeks



# PARETI VASCA / BATH SCREENS

## PRODOTTI DELLA SERIE / PRODUCTS OF THE SERIES

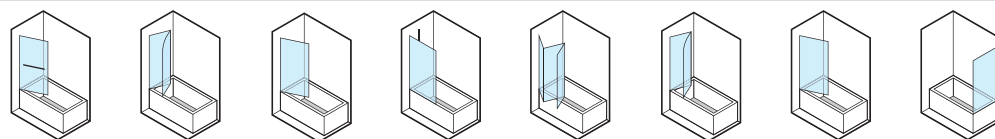

366

367

368

369

370

371

372

373

## PROFILI / PROFILES

### STANDARD



#### ULU

Brillantato Lucido  
Brilliant Polished

#### L01

Bianco Lucido  
Glossy White

## VETRO / GLASS

### STANDARD



#### TR

Trasparente  
Transparent

#### RS

Satinato  
Satin

#### SE

Setola  
Setola

**PARETE BATTENTE CON PORTASALVIETTA**  
**HINGED WALL WITH TOWEL HOLDER**



Per istruzioni di montaggio  
e ricambi inquadra il codice QR  
For assembly instructions  
and spare parts, scan the QR code



**H. 140cm**  
**SP. 6mm**

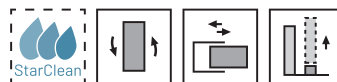

Parete vasca ad un'anta battente apribile sia verso l'interno che verso l'esterno. Sulla parte esterna è posizionato un portasalviette con interasse 450mm e lunghezza totale di 480mm. L'anta è dotata di guarnizione inferiore per evitare perdite d'acqua dal bordo. L'anta è arrotondata.

*Bathtub screen with a hinged door that can open both inward and outward. On the outer side, there is a practical towel rail with a 450mm center distance and a total length of 480mm. The door is equipped with a bottom seal to prevent water leaks from the edge. The door is rounded.*

**ORIENTAMENTO E POSSIBILI COMBINAZIONI**  
**ORIENTATION AND POSSIBLE CONFIGURATIONS**

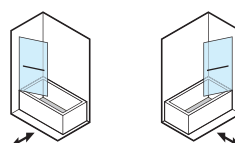

**PROFILI / PROFILES**

STANDARD	
ULU	Brilliantato Lucido Brilliant Polished
L01	Bianco Lucido Glossy White

**VETRO / GLASS**

STANDARD	
TR	Trasparente Transparent



**PARETE VASCA / BATH SCREEN**

L [cm]	COD.	[dm <sup>3</sup> ]	[kg]	Pcs	V	ULU	L01
70-72	B1670	82	18	1	TR	445,00	345,00
80-82	B1672	90	18	1	TR	470,00	360,00

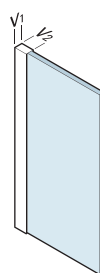

L
V <sub>1</sub> 35mm
V <sub>2</sub> 52mm

SU MISURA/CUSTOM	PARETE VASCA BATH SCREEN	[€]
↕ Altezza/Height <sup>1</sup>	120-160cm	+20%
↔ Larghezza/Width <sup>2</sup>	35-100cm	+20%
↕↔ Altezza/Height Larghezza/Width <sup>2</sup>	120-160cm 35-100cm	+20%
Altre forme Other shapes <sup>2</sup>		+30%

OPTIONAL	COD.	[€]
StarClean	Parete vasca / Bath screen	50,00

DISPONIBILITA' A MAGAZZINO/STOCK AVAILABILITY		
1/2 Settimane/Weeks	2/3 Settimane/Weeks	3/4 Settimane/Weeks
+1 StarClean Optional		

<sup>1</sup> Dal prezzo della misura di riferimento/From the price of selected size

<sup>2</sup> Dal prezzo della misura superiore/From the price of the larger size

**PARETE RIPIEGHEVOLE A DUE ANTE**  
**FOLDABLE WALL WITH TWO PANELS**



Per istruzioni di montaggio  
e ricambi inquadra il codice QR  
For assembly instructions  
and spare parts, scan the QR code



**H. 140cm**  
**SP. 6mm**

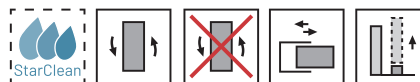

Parete vasca a due ante ripiegabili apribile sia verso l'interno che verso l'esterno. L'anta è dotata di profilo metallico inferiore in finitura dotato di guarnizione per evitare perdite d'acqua dal bordo. L'anta terminale è arrotondata

Bathtub screen with two folding doors that can open both inward and outward. The door is equipped with a lower metal profile in a finished design with a seal to prevent water leaks from the edge. The end door is rounded.

**ORIENTAMENTO E POSSIBILI COMBINAZIONI**  
**ORIENTATION AND POSSIBLE CONFIGURATIONS**

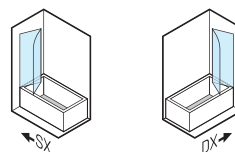

**PROFILI / PROFILES**

STANDARD	
<b>ULU</b>	Brillantato Lucido Brilliant Polished
<b>L01</b>	Bianco Lucido Glossy White

**VETRO / GLASS**

STANDARD	
<b>TR</b>	Trasparente Transparent
<b>RS</b>	Satinato Satin

Il vetro RS non è reversibile.  
Specificare lato apertura /DX o /SX.  
The RS panels are non reversible.  
Specify the opening side /DX or /SX.



**PARETE VASCA / BATH SCREEN**

L [cm]	COD.	[dm <sup>3</sup> ]	[kg]	Pcs	V	ULU	L01
105-107	<b>B1696</b>	67	26	1	TR	595,00	475,00
					RS	640,00	515,00
120-122	<b>B1697</b>	74	28	1	TR	625,00	500,00
					RS	675,00	540,00



L	V1	V2
	35mm	52mm

SU MISURA/CUSTOM	PARETE VASCA BATH SCREEN	[€]
↕ Altezza/Height <sup>1</sup>	120-160cm	+20%
↔ Larghezza/Width <sup>2</sup>	70-140cm	+20%
↕ Altezza/Height ↔ Larghezza/Width <sup>2</sup>	120-160cm 70-140cm	+20%
Altre forme Other shapes <sup>2</sup>		+30%

OPTIONAL	COD.	[€]
StarClean	Parete vasca / Bath screen	50,00

DISPONIBILITA' A MAGAZZINO/STOCK AVAILABILITY		
1/2 Settimane/Weeks +1 StarClean Optional	2/3 Settimane/Weeks	3/4 Settimane/Weeks

<sup>1</sup> Dal prezzo della misura di riferimento/From the price of selected size

<sup>2</sup> Dal prezzo della misura superiore/From the price of the larger size

PARETE BATTENTE  
HINGED WALL



Per istruzioni di montaggio  
e ricambi inquadra il codice QR  
For assembly instructions  
and spare parts, scan the QR code

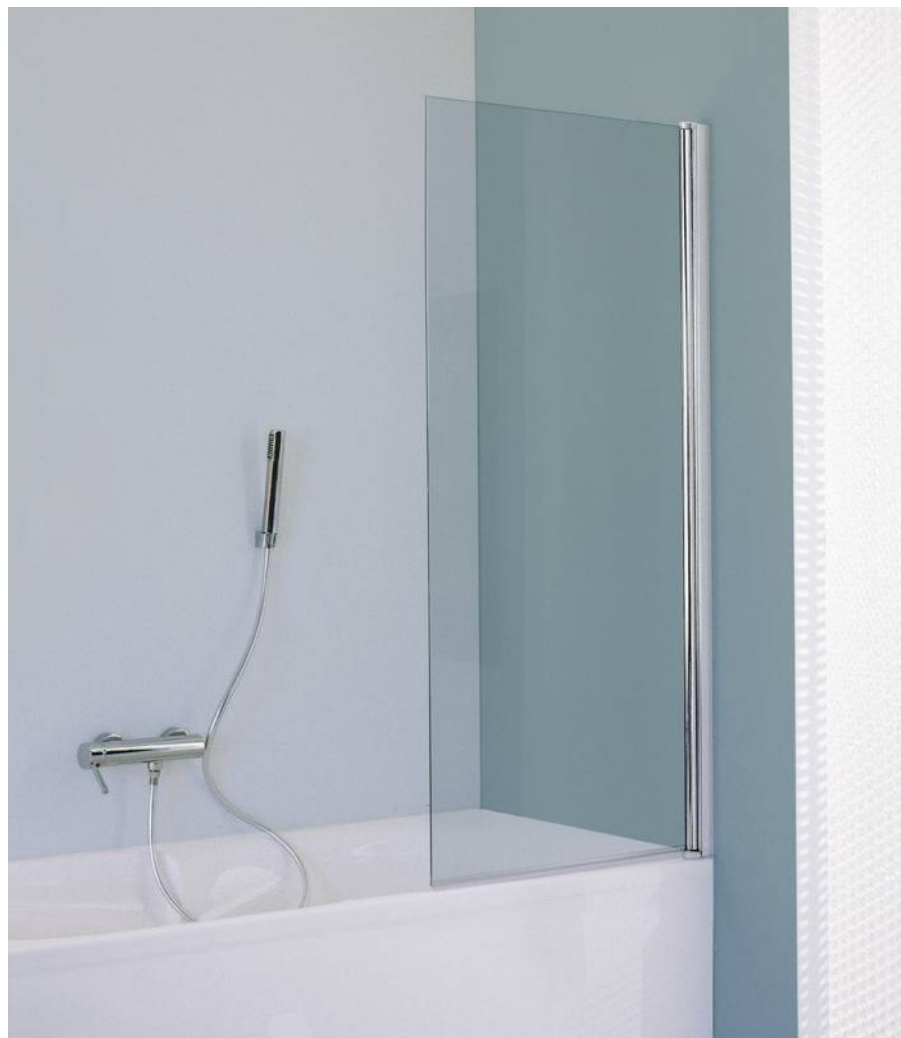

H. 140cm / H.160cm  
SP. 6mm

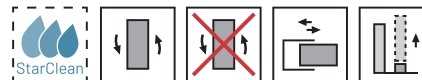

Parete vasca ad un'anta battente apribile sia verso l'interno che verso l'esterno. La gamma prevede modelli alti H.140cm e H.160cm. Ulteriore possibilità di personalizzazione sono il vetro squadrato o arrotondato.

Bathtub screen with a hinged door that can open both inward and outward. The range includes models with heights of 140cm and 160cm. Further customization options include squared or rounded glass.

ORIENTAMENTO E POSSIBILI COMBINAZIONI  
ORIENTATION AND POSSIBLE CONFIGURATIONS

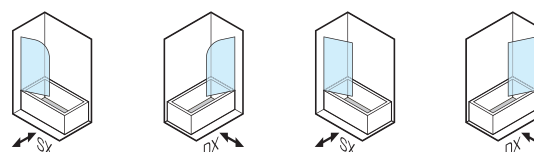

PROFILI / PROFILES

STANDARD	
ULU	Brillantato Lucido Brilliant Polished
L01	Bianco Lucido Glossy White

VETRO / GLASS

STANDARD	
TR	Trasparente Transparent
RS	Satinato Satin

Il vetro RS non è reversibile per cod. B1689-B1698-B1699  
RS glass is not reversible for code B1689-B1698-B1699  
Specify opening side /DX or /SX

PARETE VASCA / BATH SCREEN

L [cm]	COD.	[dm <sup>3</sup> ]	[kg]	Pcs	V	ULU	L01
75-77	B1689	78	20	1	TR	365,00	305,00
					RS	395,00	330,00
85-87	B1698	95	22	1	TR	400,00	335,00
					RS	430,00	360,00
85-87	B1699	108	25	1	TR	420,00	350,00
					RS	455,00	380,00
75-77	B1685	78	20	1	TR	365,00	305,00
					RS	395,00	330,00
85-87	B1690	95	22	1	TR	400,00	335,00
					RS	430,00	360,00
85-87	B1695	108	25	1	TR	420,00	350,00
					RS	455,00	380,00



L	
V <sub>1</sub>	35mm
V <sub>2</sub>	52mm

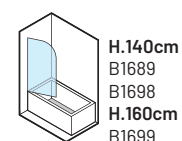

H.140cm  
B1689  
B1698  
H.160cm  
B1699

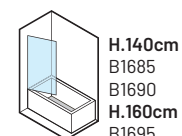

H.140cm  
B1685  
B1690  
H.160cm  
B1695

SU MISURA/CUSTOM	PARETE VASCA BATH SCREEN	[€]
Altezza/Height <sup>1</sup>	120-160cm	+20%
Larghezza/Width <sup>2</sup>	35-100cm	+20%
Altezza/Height Larghezza/Width <sup>2</sup>	120-160cm 35-100cm	+20%
Altre forme Other shapes <sup>2</sup>		+30%

OPTIONAL	COD.	[€]
StarClean	Parete vasca / Bath screen	50,00

DISPONIBILITA' A MAGAZZINO/STOCK AVAILABILITY

1/2 Settimane/Weeks +1 StarClean Optional	2/3 Settimane/Weeks	3/4 Settimane/Weeks
--	---------------------	---------------------

<sup>1</sup> Dal prezzo della misura di riferimento/From the price of selected size

<sup>2</sup> Dal prezzo della misura superiore/From the price of the larger size

PARETE FISSA  
FIXED PANEL



Per istruzioni di montaggio  
e ricambi inquadra il codice QR  
For assembly instructions  
and spare parts, scan the QR code



H. 140cm  
SP. 6mm

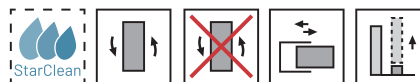

Parete vasca ad anta fissa. Possibilità di personalizzazione sono il vetro squadrato o arrotondato.  
Possibilità di integrare nell'acquisto la staffa di rinforzo opzionale per aumentare la stabilità del prodotto.

Fixed panel bathtub screen. Customization options include squared or rounded glass.  
It is possible to add an optional reinforcement bracket to increase the product's stability.

ORIENTAMENTO E POSSIBILI COMBINAZIONI  
ORIENTATION AND POSSIBLE CONFIGURATIONS

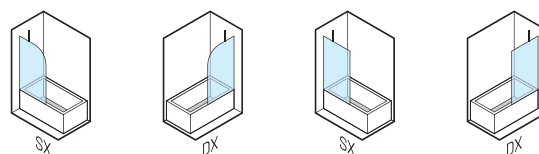

PROFILI / PROFILES

STANDARD	
ULU	Brillantato Lucido Brilliant Polished
L01	Bianco Lucido Glossy White

VETRO / GLASS

STANDARD	
TR	Trasparente Transparent
RS	Satinato Satin

Il vetro RS non è reversibile per cod. B1650-B1660  
RS glass is not reversible for B1650-B1660  
Specificare lato apertura /DX o /SX.  
Specify opening side /DX or /SX.



PARETE VASCA / BATH SCREEN

L [cm]	COD.	[dm <sup>3</sup> ]	[kg]	Pcs	V	ULU	L01
75-77	B1650	87	24	1	TR	325,00	260,00
					RS	355,00	285,00
85-87	B1660	91	26	1	TR	345,00	280,00
					RS	390,00	310,00
75-77	B1655	87	24	1	TR	325,00	260,00
					RS	355,00	285,00
85-87	B1665	91	26	1	TR	345,00	280,00
					RS	390,00	310,00

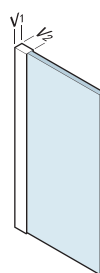

L	
V <sub>1</sub>	35mm
V <sub>2</sub>	52mm

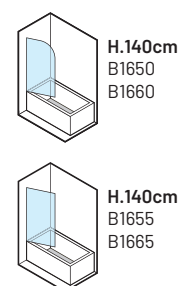

SU MISURA/CUSTOM	PARETE VASCA BATH SCREEN	[€]
Altezza/Height <sup>1</sup>	120-160cm	+20%
Larghezza/Width <sup>2</sup>	70-140cm	+20%
Altezza/Height Larghezza/Width <sup>2</sup>	120-160cm 70-140cm	+20%
Altre forme Other shapes <sup>2</sup>		+30%

OPTIONAL	COD.	[€]
Zanca snodata Articulated bracket <sup>3</sup>	RIC2371	L01 55,00 ULU 60,00
StarClean	Parete vasca / Bath screen	50,00

<sup>1</sup> Dal prezzo della misura di riferimento/From the price of selected size  
<sup>2</sup> Dal prezzo della misura superiore/From the price of the larger size  
<sup>3</sup> Da richiedere al momento dell'ordine / To be requested at the time of order

DISPONIBILITA' A MAGAZZINO/STOCK AVAILABILITY

1/2 Settimane/Weeks	2/3 Settimane/Weeks	3/4 Settimane/Weeks
+1 StarClean Optional		

**PARETE PIEGHEVOLE A TRE ANTE**  
**FOLDABLE WALL WITH THREE PANELS**



Per istruzioni di montaggio  
e ricambi inquadra il codice QR  
For assembly instructions  
and spare parts, scan the QR code



**H. 135cm**  
**SP. 3mm**

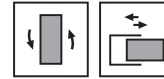

Parete vasca a tre ante ripiegabili apribile verso l'interno o verso l'esterno. Ingombro delle ante chiuse di 77mm. Il verso di apertura si stabilisce durante l'installazione del prodotto. Modello compatibile con parete fissa per creare chiusure su due lati.

*Three-panel folding bathtub screen, openable both inwards and outwards. When closed, the panels take up 77 mm of space. The opening direction can be decided during the product installation. This model is compatible with a fixed wall to create two-sided enclosures.*

**ORIENTAMENTO E POSSIBILI COMBINAZIONI**  
**ORIENTATION AND POSSIBLE CONFIGURATIONS**

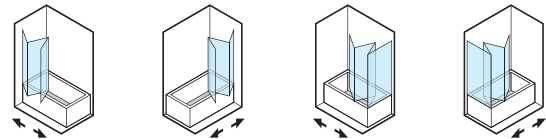

**PROFILI / PROFILES**

STANDARD	
L01	Bianco Lucido Glossy White

**VETRO / GLASS**

STANDARD	
TR	Trasparente Transparent
SE	Setola Setola

**PARETE VASCA / BATH SCREEN**

L [cm]	COD.	[dm <sup>3</sup> ]	[kg]	Pcs	V	L01
137-139	B1384	66	26 14	1 1	TR SE	355,00 310,00

**PARETE FISSA / FIXED PANEL**

L1 [cm]	COD.	[dm <sup>3</sup> ]	[kg]	Pcs	V	L01
63-67	B1393	65	13 6	13 6	TR SE	240,00 210,00
68-72	B1390	70	13 6	13 6	TR SE	240,00 210,00
73-77	B1391	74	13 7	13 7	TR SE	245,00 215,00
78-82	B1392	75	13 7	13 7	TR SE	245,00 220,00

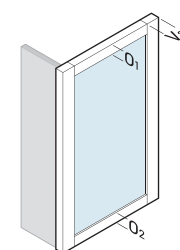
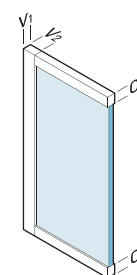

L	
V <sub>1</sub>	29mm
V <sub>2</sub>	50mm
O <sub>1</sub>	35mm
O <sub>2</sub>	35mm

L1	
V <sub>2</sub>	30mm
O <sub>1</sub>	35mm
O <sub>2</sub>	35mm

SU MISURA/CUSTOM	PARETE VASCA BATH SCREEN	[€]
↕ Altezza/Height <sup>1</sup>	120-160cm	+20%
↔ Larghezza/Width <sup>2</sup>	60-145cm	+20%
↕ Altezza/Height ↔ Larghezza/Width <sup>2</sup>	120-160cm 60-145cm	+20%
Altre forme Other shapes <sup>2</sup>		+30%

<sup>1</sup> Dal prezzo della misura di riferimento/From the price of selected size  
<sup>2</sup> Dal prezzo della misura superiore/From the price of the larger size

DISPONIBILITA' A MAGAZZINO/STOCK AVAILABILITY		
1/2 Settimane/Weeks	2/3 Settimane/Weeks	3/4 Settimane/Weeks

**PARETE PIEGHEVOLE A DUE ANTE**  
**FOLDABLE WALL WITH TWO PANELS**



Per istruzioni di montaggio  
e ricambi inquadra il codice QR  
For assembly instructions  
and spare parts, scan the QR code



**H. 135cm**  
**SP. 3mm**

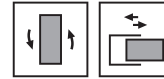

Parete vasca a due ante ripiegabili apribile verso l'interno o verso l'esterno. Ingombro delle ante chiuse di 62mm. Il verso di apertura si stabilisce durante l'installazione del prodotto. Modello compatibile con parete fissa per creare chiusure su due lati.

*Two-panel folding bathtub screen, openable both inwards and outwards. When closed, the panels take up 62mm of space. The opening direction can be decided during the product installation. This model is compatible with a fixed wall to create two-sided enclosures.*

**ORIENTAMENTO E POSSIBILI COMBINAZIONI**  
**ORIENTATION AND POSSIBLE CONFIGURATIONS**

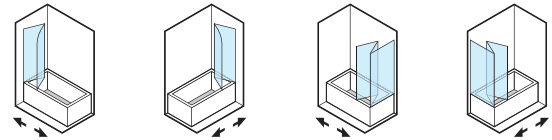

**PROFILI / PROFILES**

STANDARD	
L01	Bianco Lucido Glossy White

**VETRO / GLASS**

STANDARD	
TR	Trasparente Transparent
SE	Setola Setola

**PARETE VASCA / BATH SCREEN**

L [cm]	COD.	[dm <sup>3</sup> ]	[kg]	Pcs	V	L01
126-128	B1385	72	17 10	1 1	TR SE	300,00 260,00

**PARETE FISSA / FIXED PANEL**

L1 [cm]	COD.	[dm <sup>3</sup> ]	[kg]	Pcs	V	L01
63-67	B1393	65	13 6	13 6	TR SE	240,00 210,00
68-72	B1390	70	13 6	13 6	TR SE	240,00 210,00
73-77	B1391	74	13 7	13 7	TR SE	245,00 215,00
78-82	B1392	75	13 7	13 7	TR SE	245,00 220,00

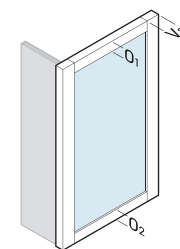
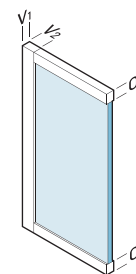

L	
V <sub>1</sub>	29mm
V <sub>2</sub>	50mm
O <sub>1</sub>	35mm
O <sub>2</sub>	35mm

L1	
V <sub>2</sub>	30mm
O <sub>1</sub>	35mm
O <sub>2</sub>	35mm

SU MISURA/CUSTOM	PARETE VASCA BATH SCREEN	[€]
↕ Altezza/Height <sup>1</sup>	120-160cm	+20%
↔ Larghezza/Width <sup>2</sup>	50-135cm	+20%
↕ Altezza/Height ↔ Larghezza/Width <sup>2</sup>	120-160cm 50-135cm	+20%
Altre forme Other shapes <sup>2</sup>		+30%

<sup>1</sup> Dal prezzo della misura di riferimento/From the price of selected size  
<sup>2</sup> Dal prezzo della misura superiore/From the price of the larger size  
<sup>3</sup> Da richiedere al momento dell'ordine / To be requested at the time of order

**DISPONIBILITA' A MAGAZZINO/STOCK AVAILABILITY**

1/2 Settimane/Weeks    2/3 Settimane/Weeks    3/4 Settimane/Weeks

**PARETE BATTENTE**  
**HINGED WALL**



Per istruzioni di montaggio  
e ricambi inquadra il codice QR  
For assembly instructions  
and spare parts, scan the QR code



**H. 135cm**  
**SP. 3mm**

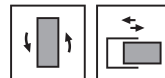

Parete vasca ad un'anta battente apribile sia verso l'interno che verso l'esterno. Modello compatibile con parete fissa per creare chiusure su due lati.

Bathtub screen with a single hinged panel that opens both inwards and outwards. This model is compatible with a fixed wall to create closures on two sides.

**ORIENTAMENTO E POSSIBILI COMBINAZIONI**  
**ORIENTATION AND POSSIBLE CONFIGURATIONS**

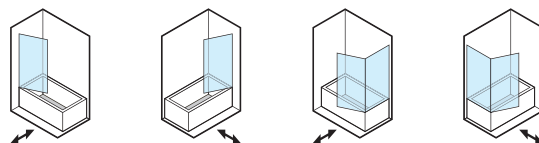

**PROFILI / PROFILES**

STANDARD	
L01	Bianco Lucido Glossy White

**VETRO / GLASS**

STANDARD	
TR	Trasparente Transparent
SE	Setola Setola

**PARETE VASCA / BATH SCREEN**

L [cm]	COD.	[dm <sup>3</sup> ]	[kg]	Pcs	V	L01
75-77	B1382	81	14 6	1 1	TR SE	225,00 190,00

**PARETE FISSA / FIXED PANEL**

L1 [cm]	COD.	[dm <sup>3</sup> ]	[kg]	Pcs	V	L01
63-67	B1393	65	13 6	13 6	TR SE	240,00 210,00
68-72	B1390	70	13 6	13 6	TR SE	240,00 210,00
73-77	B1391	74	13 7	13 7	TR SE	245,00 215,00
78-82	B1392	75	13 7	13 7	TR SE	245,00 220,00

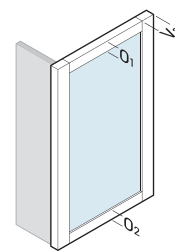
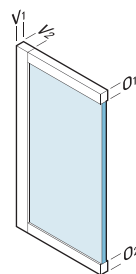

L	
V <sub>1</sub>	29mm
V <sub>2</sub>	50mm
O <sub>1</sub>	35mm
O <sub>2</sub>	35mm

L1	
V <sub>2</sub>	30mm
O <sub>1</sub>	35mm
O <sub>2</sub>	35mm

SU MISURA/CUSTOM	PARETE VASCA BATH SCREEN	[€]
↕ Altezza/Height <sup>1</sup>	120-160cm	+20%
↔ Larghezza/Width <sup>2</sup>	25-90cm	+20%
↕ Altezza/Height ↔ Larghezza/Width <sup>2</sup>	120-160cm 25-90cm	+20%
Altre forme Other shapes <sup>2</sup>		+30%

<sup>1</sup> Dal prezzo della misura di riferimento/From the price of selected size

<sup>2</sup> Dal prezzo della misura superiore/From the price of the larger size

**DISPONIBILITÀ A MAGAZZINO/STOCK AVAILABILITY**

1/2 Settimane/Weeks

2/3 Settimane/Weeks

3/4 Settimane/Weeks

**PARETE FISSA PER ABBINAMENTI**  
**FIXED PANEL FOR COMBINATIONS**



Per istruzioni di montaggio  
e ricambi inquadra il codice QR  
For assembly instructions  
and spare parts, scan the QR code



**H. 135cm**  
**SP. 3mm**

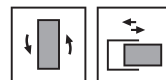

Parete fissa per abbinamenti. È possibile utilizzarla in abbinamento al modello di parete doccia selezionato per realizzare installazioni ad angolo.

*Fixed panel for combinations. It can be used in combination with the selected shower enclosure model to create corner installations.*

**ORIENTAMENTO E POSSIBILI COMBINAZIONI**  
**ORIENTATION AND POSSIBLE CONFIGURATIONS**

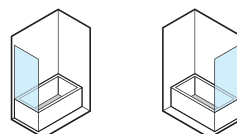

**PROFILI / PROFILES**

STANDARD	
L01	Bianco Lucido Glossy White

**VETRO / GLASS**

STANDARD	
TR	Trasparente Transparent
SE	Setola Setola



**PARETE FISSA / FIXED PANEL**

L1 [cm]	COD.	[dm <sup>3</sup> ]	[kg]	Pcs	V	L01
63-67	B1393	65	13	13	TR	240,00
			6	6	SE	210,00
68-72	B1390	70	13	13	TR	240,00
			6	6	SE	210,00
73-77	B1391	74	13	13	TR	245,00
			7	7	SE	215,00
78-82	B1392	75	13	13	TR	245,00
			7	7	SE	220,00

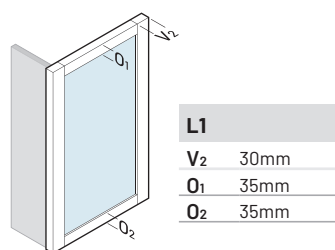

SU MISURA/CUSTOM	PARETE VASCA BATH SCREEN	[€]
↕ Altezza/Height <sup>1</sup>	120-160cm	+20%
↔ Larghezza/Width <sup>2</sup>	20-100cm	+20%
↕ Altezza/Height ↔ Larghezza/Width <sup>2</sup>	120-160cm 20-100cm	+20%
Altre forme Other shapes <sup>2</sup>		+30%

DISPONIBILITA' A MAGAZZINO/STOCK AVAILABILITY		
1/2 Settimane/Weeks	2/3 Settimane/Weeks	3/4 Settimane/Weeks

<sup>1</sup> Dal prezzo della misura di riferimento/From the price of selected size  
<sup>2</sup> Dal prezzo della misura superiore/From the price of the larger size  
<sup>3</sup> Da richiedere al momento dell'ordine / To be requested at the time of order

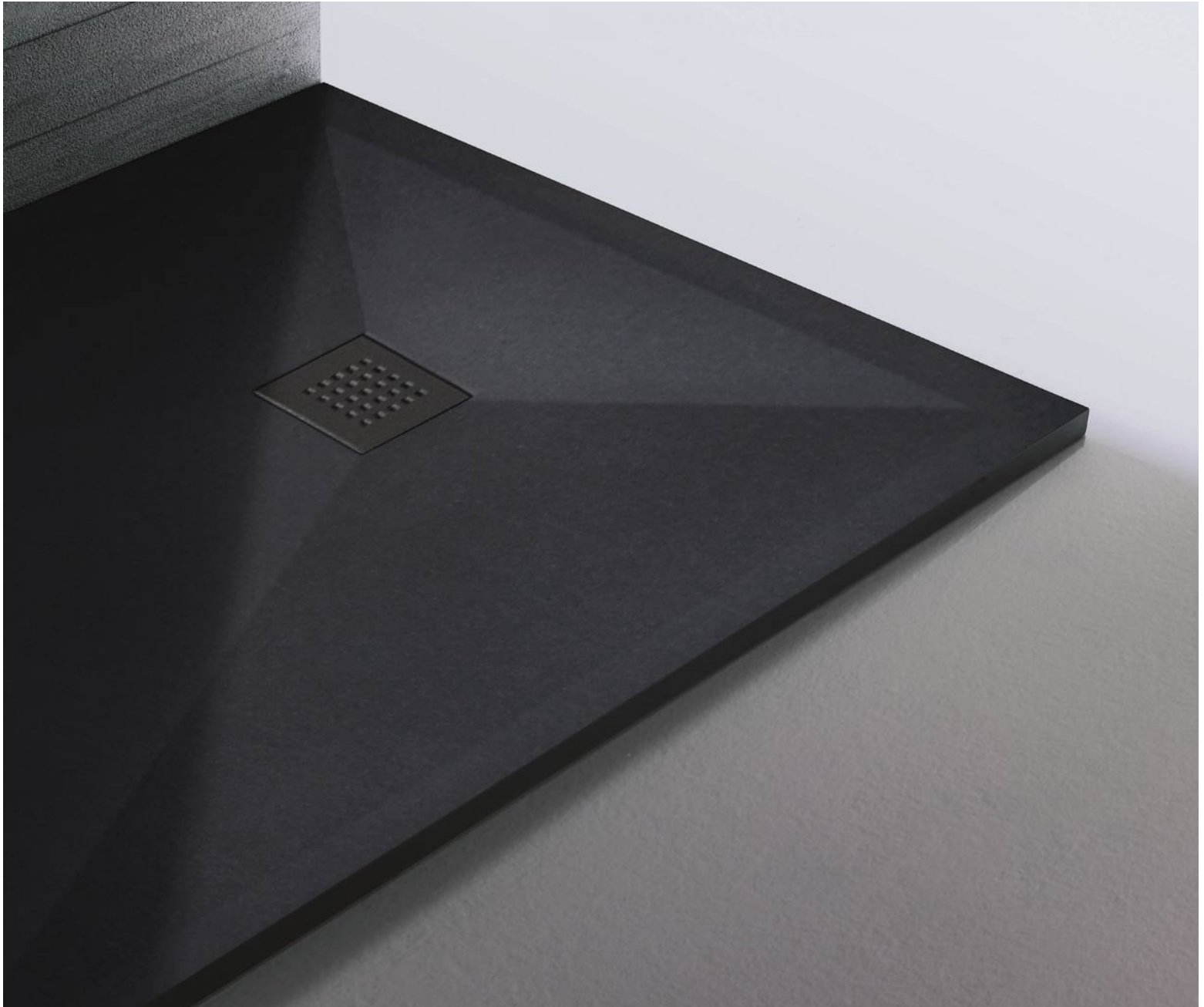

La proposta di piatti in StoneFit cresce ulteriormente offrendo una proposizione cromatica con l'inserimento di colorazioni che ben si adattano alla voglia di continuo cambiamento stilistico. Di grande impatto la nuova texture "effetto goffrato" che dona ai piatti doccia un'esperienza sensoriale indimenticabile e al tempo stesso garantisce stabilità e sicurezza con il suo effetto antiscivolo.

StoneFit diventa sinonimo di "su misura". Il nome stesso del prodotto è l'unione del termine Stone per indicare le caratteristiche di resistenza e di sensazione tattile, e del suffisso Fit (letteralmente, "su misura") per indicare la possibilità di poter contare su un prodotto sartoriale grazie alla scelta della misura al centimetro. Il taglio del piatto può essere eseguito sia in larghezza che in lunghezza: la natura di questo materiale permette di tagliarlo e plasmarlo come si desidera. La possibilità di richiedere forme specifiche, inoltre, garantisce la soluzione ottimale in tutte le circostanze: ostacoli e colonne sono ora facilmente superabili grazie alla possibilità di sagomare i piatti tramite l'uso di specifici utensili (tipo "flex").

La gamma prodotti Stone nasce invece dalla volontà di mettere a disposizione dell'acquirente nel minor tempo possibile un piatto doccia in "mineralmarmo" con le stesse caratteristiche strutturali dello StoneFit. Di grande impatto la texture che dona ai piatti stessi una sensazione sensoriale indimenticabile e al tempo stesso garantisce stabilità e sicurezza grazie all'effetto antiscivolo. Misure stabilite, colori essenziali: bianco, grigio, nero.

*The StoneFit shower tray range continues to expand, offering a new color palette that perfectly aligns with the desire for continuous stylistic evolution. The new 'embossed effect' texture is particularly striking, providing an unforgettable sensory experience while also ensuring stability and safety with its anti-slip effect.*

*StoneFit becomes synonymous with 'custom-made.' The product's name itself combines 'Stone,' referring to its strength and tactile sensation, with the suffix 'Fit' (literally, 'custom-fit') to indicate the option of a tailor-made product with measurements down to the centimeter. The shower tray can be cut both in width and length: the nature of this material allows it to be shaped and cut as desired. Additionally, the possibility of requesting specific shapes guarantees the optimal solution in any situation: obstacles and columns are now easily overcome thanks to the ability to shape the trays using specific tools (such as a grinder).*

*The Stone product range, on the other hand, was created to offer the customer a mineralguss shower tray as quickly as possible, with the same structural characteristics as StoneFit. The texture is particularly impactful, providing an unforgettable sensory experience while also ensuring stability and safety thanks to its anti-slip effect. Standard sizes, essential colors: white, grey, black.*

# PIATTI DOCCIA / SHOWER TRAYS

## PRODOTTI DELLA SERIE / PRODUCTS OF THE SERIES

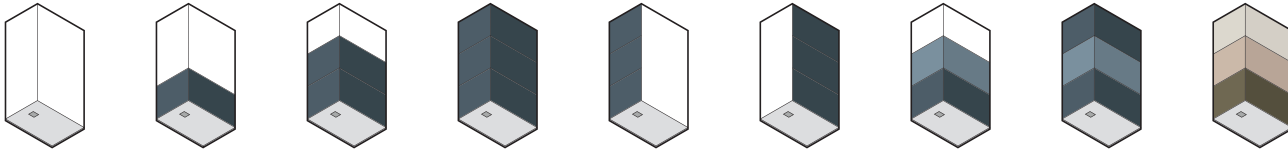

## STONEFIT



**R01**  
Bianco  
White

**R06**  
Nero  
Black

**R08**  
Sabbia  
Sand

**R10**  
Artic  
Artic

**R17**  
Grigio  
Grey

**R19**  
Tortora  
Tortora

## STONE



**R01**  
Bianco  
White

**R06**  
Nero  
Black

**R17**  
Grigio  
Grey

# STONEFIT

## PIATTO DOCCIA QUADRATO O RETTANGOLARE + RIVESTIMENTO A PARETE SQUARED OR RECTANGULAR SHOWER TRAY + WALL COVERING

Per istruzioni di montaggio  
e ricambi inquadra il codice QR  
For assembly instructions  
and spare parts, scan the QR code

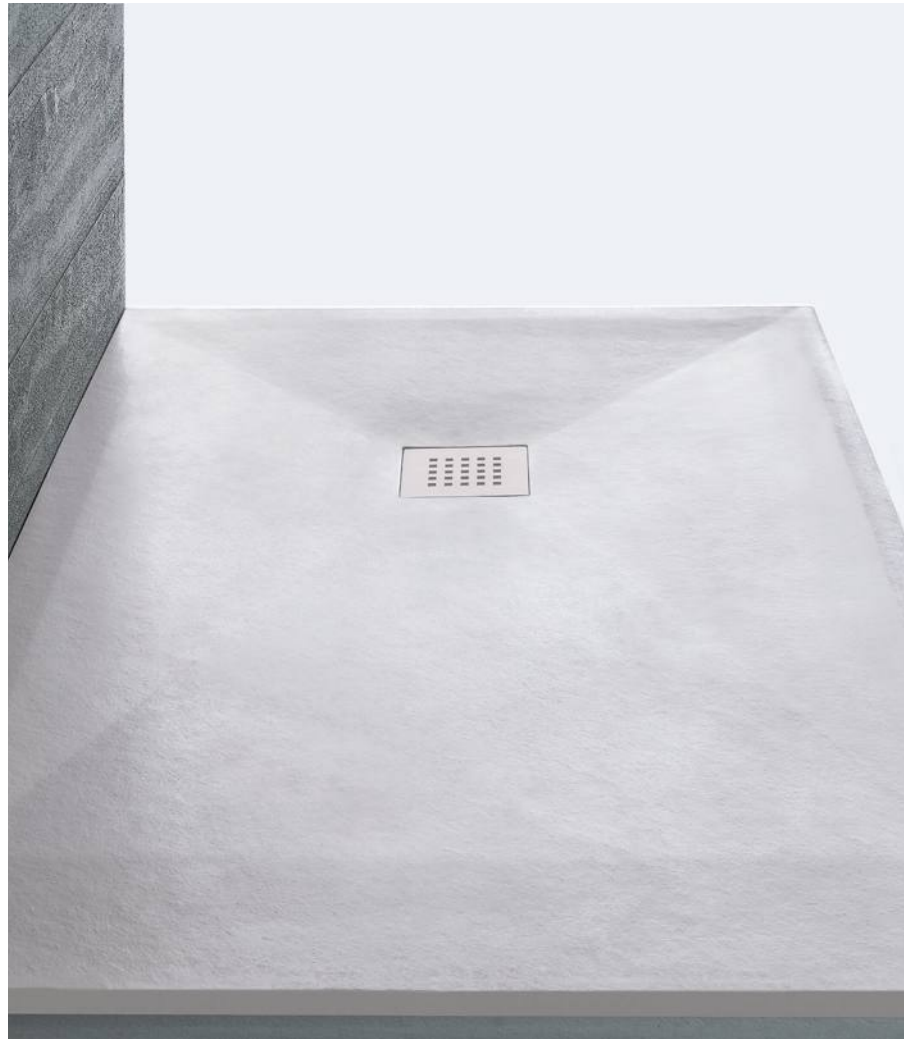

### SP. 3cm (piatto doccia / shower tray) SP. 1,2cm (rivestimento / wall covering)

Piatto doccia in mineralmarmo disponibile in numerose misure e finiture. La gamma finiture è stata studiata per abbinarsi perfettamente alle finiture ATELIER della proposta di pareti doccia Samo. Possibilità di realizzare piatti doccia sagomati su misura, a seconda delle esigenze del cliente.

La gamma StonFit prevede anche la possibilità di abbinare al piatto doccia, il suo rivestimento dedicato, sempre con finiture perfettamente abbinabili.

*Shower tray in mineralguss available in numerous sizes and finishes. The range of finishes has been designed to perfectly match the ATELIER finishes of the Samo shower wall proposal.*

*There is the possibility to create custom-shaped shower trays according to the customer's needs.*

*The StoneFit range also offers the option to match the shower tray with its dedicated covering, always with perfectly complementary finishes.*

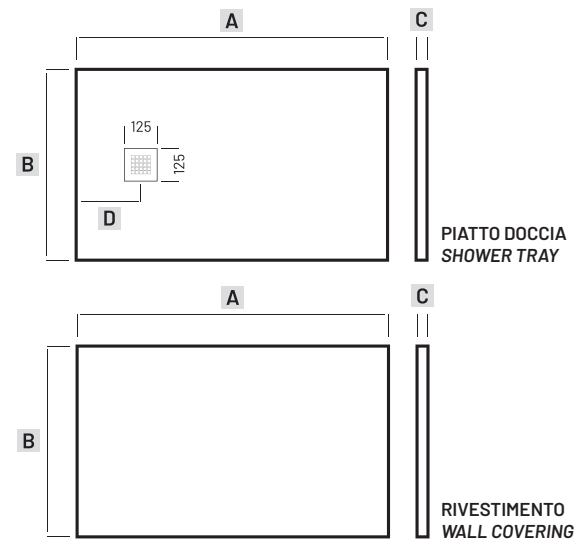

### IDEE DI COMBINAZIONE RIVESTIMENTO A PARETE / WALL COVERING COMBINATION IDEAS

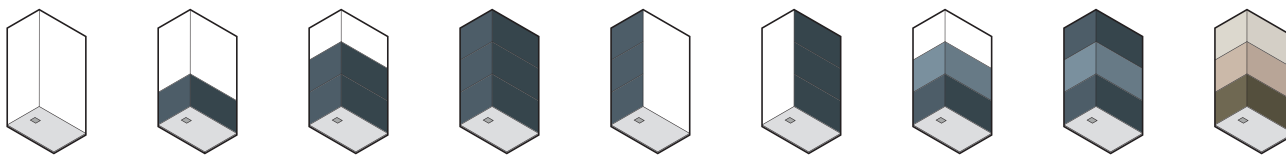

#### PIATTI DOCCIA / SHOWER TRAYS

STANDARD	
R01	Bianco White
R06	Nero Black
R08	Sabbia Sand
R10	Artic Artic
R17	Grigio Grey
R19	Tortora Dove

#### RIVESTIMENTO / WALL COVERING

STANDARD	
R01	Bianco White
R06	Nero Black
R08	Sabbia Sand
R10	Artic Artic
R17	Grigio Grey
R19	Tortora Dove

## PIATTO DOCCIA / SHOWER TRAYS

B [cm]	A [cm]	COD.	C [cm]	D [cm]	[kg]	[Pcs]	R01	R06	R08	R10	R17	R19
70	90	D3671	3	30	17	1	745,00	745,00	745,00	745,00	745,00	745,00
70	100	D3672	3	30	21	1	745,00	745,00	745,00	745,00	745,00	745,00
70	120	D3673	3	30	25	1	795,00	795,00	795,00	795,00	795,00	795,00
70	140	D3674	3	40	29	1	870,00	870,00	870,00	870,00	870,00	870,00
70	160	D3675	3	40	34	1	970,00	970,00	970,00	970,00	970,00	970,00
70	180	D3676	3	40	38	1	1.070,00	1.070,00	1.070,00	1.070,00	1.070,00	1.070,00
80	80	D3680	3	30	19	1	760,00	760,00	760,00	760,00	760,00	760,00
80	100	D3682	3	30	24	1	760,00	760,00	760,00	760,00	760,00	760,00
80	120	D3683	3	30	29	1	820,00	820,00	820,00	820,00	820,00	820,00
80	140	D3684	3	40	34	1	895,00	895,00	895,00	895,00	895,00	895,00
80	160	D3685	3	40	38	1	990,00	990,00	990,00	990,00	990,00	990,00
80	180	D3686	3	40	43	1	1.100,00	1.100,00	1.100,00	1.100,00	1.100,00	1.100,00
90	90	D3690	3	35	24	1	815,00	815,00	815,00	815,00	815,00	815,00
90	100	D3692	3	35	27	1	815,00	815,00	815,00	815,00	815,00	815,00
90	120	D3693	3	40	32	1	865,00	865,00	865,00	865,00	865,00	865,00
90	140	D3694	3	40	38	1	980,00	980,00	980,00	980,00	980,00	980,00
90	160	D3695	3	45	43	1	1.075,00	1.075,00	1.075,00	1.075,00	1.075,00	1.075,00
90	180	D3696	3	50	49	1	1.150,00	1.150,00	1.150,00	1.150,00	1.150,00	1.150,00

! Superficie esterna ad effetto gofrato antiscivolo.  
 Possibilità di incassare il piatto a muro, coprendolo con il rivestimento a parete, di massimo 2cm.  
 Tubo di scarico universale fornito in dotazione. Vedere disegni tecnici qui sotto per maggiori dettagli.  
 Piletta di scarico KS3000 in dotazione. Copripiletta in tinta con il piatto doccia di serie (RIC2346R01-R06-R08-R10-R17-R19).  
 Embossed, anti-slip external surface.  
 Possibility to recess the tray into the wall, covering it with the wall covering, up to a maximum of 2 cm.  
 Universal drain pipe included. See technical drawings below for further details.  
 KS3000 drain included. Drain cover in matching color with the shower tray as standard (RIC2346R01-R06-R08-R10-R17-R19).

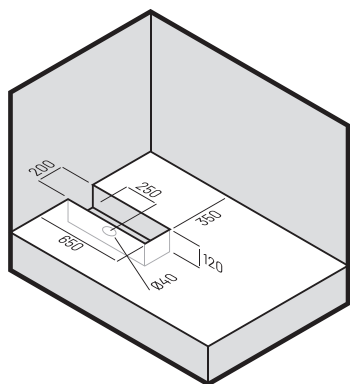

Installazione in appoggio a pavimento  
 Misure espresse in mm.

Floor-mounted installation  
 Measurements expressed in mm.

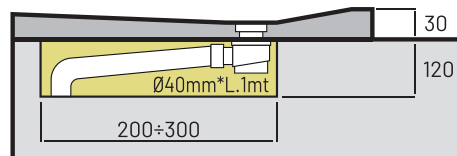

Miscela Sabbia-Cemento Sand-Cement Mix    Massetto-Pavimento Screed-Floor

Installazione a filo pavimento  
 Misure espresse in mm.

Flush-to-floor installation  
 Measurements expressed in mm.

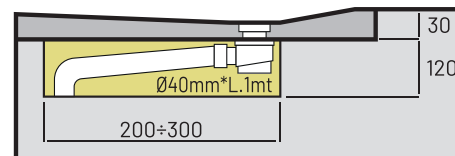

## RIVESTIMENTO / WALL COVERING

B [cm]	A [cm]	COD.	C [cm]	D [cm]	[kg]	[Pcs]	STANDARD
70	100	RV3670100	1,2	-	15	1	450,00
70	140	RV3670140	1,2	-	21	1	450,00
70	180	RV3670180	1,2	-	27	1	450,00

SU MISURA/CUSTOM	PIATTI DOCCIA SHOWER TRAYS	[€]
↑ ↓ Altezza/Height <sup>1</sup>		0,00
← → Larghezza/Width <sup>2</sup>		+20%

<sup>1</sup> Taglio compreso nel prezzo/Cut included in the price

<sup>2</sup> Dal prezzo della misura superiore/From the price of the larger size

DISPONIBILITÀ A MAGAZZINO/STOCK AVAILABILITY

1/2 Settimane/Weeks

2/3 Settimane/Weeks

3/4 Settimane/Weeks

# STONE

## PIATTO DOCCIA QUADRATO O RETTANGOLARE SQUARED OR RECTANGULAR SHOWER TRAY

Per istruzioni di montaggio  
e ricambi inquadra il codice QR  
For assembly instructions  
and spare parts, scan the QR code



### SP. 3cm

Piatto doccia in mineralmarmo disponibile nelle finiture e nelle dimensioni più diffuse sul mercato. La veloce disponibilità del prodotto lo rende ideale per installazioni da realizzare in brevi tempi e con certezza del risultato.

*Shower tray in mineralguss available in the most popular finishes and sizes on the market. The quick availability of the product makes it ideal for installations that need to be completed in a short time with guaranteed results.*

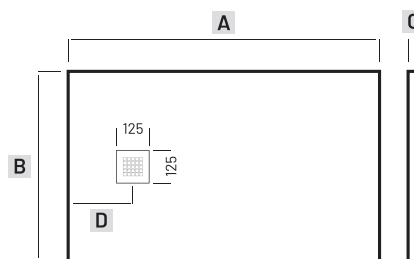

### PRODOTTI DELLA SERIE / PRODUCTS OF THE SERIES

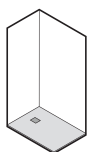

#### STANDARD

R01 Bianco  
White

R06 Nero  
Black

R17 Grigio  
Grey

## PIATTO DOCCIA / SHOWER TRAYS

B [cm]	A [cm]	COD.	C [cm]	D [cm]	[kg]	[Pcs]	R01	R06	R17
70	90	D3071	3	20	16	1	455,00	455,00	455,00
70	100	D3072	3	20	31	1	520,00	520,00	520,00
70	120	D3073	3	20	39	1	615,00	615,00	615,00
70	140	D3074	3	20	46	1	650,00	650,00	650,00
80	80	D3080	3	20	25	1	435,00	435,00	435,00
80	100	D3081	3	20	44	1	550,00	550,00	550,00
80	120	D3082	3	20	52	1	640,00	640,00	640,00
80	140	D3083	3	20	61	1	695,00	695,00	695,00
90	90	D3090	3	20	36	1	485,00	485,00	485,00
90	100	D3091	3	20	46	1	575,00	575,00	575,00
90	120	D3092	3	20	56	1	680,00	680,00	680,00
90	140	D3093	3	20	66	1	735,00	735,00	735,00



Superficie esterna ad effetto goffrato antiscivolo.

Possibilità di incassare il piatto a muro, coprendolo con il rivestimento a parete, di massimo 2cm.

Tubo di scarico universale fornito in dotazione. Vedere disegni tecnici qui sotto per maggiori dettagli.

Piletta di scarico KS3000 optional. Copripiletta inox satinato di serie (RIC1778SAT).

Embossed, anti-slip external surface.

Possibility to recess the tray into the wall, covering it with the wall covering, up to a maximum of 2 cm.

Universal drain pipe included. See technical drawings below for further details.

KS3000 drain optional. Satin-finished stainless steel drain cover included as standard (RIC1778SAT).

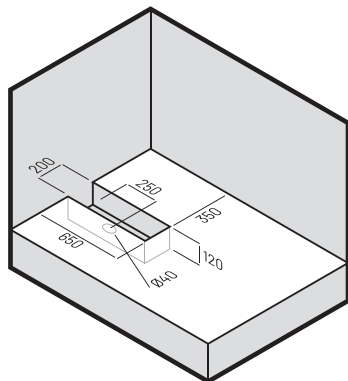

Installazione in appoggio a pavimento  
Misure espresse in mm.

Floor-mounted installation  
Measurements expressed in mm.

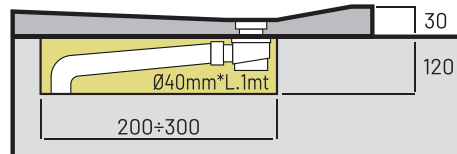

Miscela Sabbia-Cemento  
Sand-Cement Mix

Massetto-Pavimento  
Screed-Floor

Installazione a filo pavimento  
Misure espresse in mm.

Flush-to-floor installation  
Measurements expressed in mm.

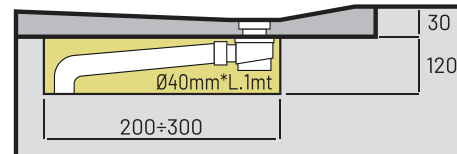

OPTIONAL	COD.	[€]
Piletta di scarico Drain hole optional	KS3000	90,00
Griglia copripiletta Drain cover grille	RIC1778SAT R01-R06-R17	80,00

DISPONIBILITA' A MAGAZZINO/STOCK AVAILABILITY

1/2 Settimane/Weeks

2/3 Settimane/Weeks

3/4 Settimane/Weeks

**PRODOTTI SPECIALI / SPECIAL PRODUCTS**



# COMPOSIZIONE CODICE SPECIALE / SPECIAL CODE COMPOSITION

L [cm]	COD.	A [cm]	B [cm]	C [cm]	[dm3]	[kg]	[n°]	V	ULU	L96	L91	DOLCEVITA
117-121	<b>B3984</b>	43,5	69,1	68	138	42	1	TR				
								AS-RF				



Per la creazione del codice del prodotto speciale bisogna aggiungere la lettera **S** tra la lettera **B** (Tipologia di prodotto) e il numero di Serie del modello-misura  
 To create the special product code, add the letter "S" between the letter "B" and the "serial number" of the requested article



Per la creazione del codice del prodotto speciale con StarClean optional bisogna aggiungere la lettera **R** tra la lettera **B** (Tipologia di prodotto) e il numero di Serie del modello-misura  
 To create the special product code with optional StarClean, you must add the letter "R" between the letter "B" (Product Type) and the serial number of the model-size

Standard	Maggiorazione Surcharge	Forme Speciali / Special Shapes			
	<b>+20%</b>	 ALTEZZA inferiore <sup>1</sup> Lower HEIGHT <sup>1</sup>	 ALTEZZA superiore <sup>1</sup> Greater HEIGHT <sup>1</sup>	 LARGHEZZA inferiore <sup>2</sup> Lower WIDTH <sup>2</sup>	 LARGHEZZA superiore <sup>2</sup> Greater WIDTH <sup>2</sup>
	<b>+20%</b>	 ALTEZZA inferiore LARGHEZZA inferiore <sup>2</sup> Lower HEIGHT / Lower WIDTH <sup>2</sup>	 ALTEZZA superiore LARGHEZZA inferiore <sup>2</sup> Greater HEIGHT / Lower WIDTH <sup>2</sup>	 ALTEZZA inferiore LARGHEZZA superiore <sup>2</sup> Lower HEIGHT / Greater WIDTH <sup>2</sup>	 ALTEZZA superiore LARGHEZZA superiore <sup>2</sup> Greater HEIGHT / Greater WIDTH <sup>2</sup>
	<b>+30%</b>	 VETRO ritagliato <sup>2</sup> GLASS Beveled <sup>2</sup>	 VETRO sopra muretto <sup>2</sup> GLASS over a low wall <sup>2</sup>	 VETRO sagomato <sup>2</sup> GLASS round <sup>2</sup>	 LARGHEZZA ante personalizzata <sup>2</sup> WIDTH customized doors <sup>2</sup>
	<b>T.B.D</b>	Tipologie di prodotti speciali non contemplate nella tabella qui sopra. Si prega di contattare l'ufficio clienti per avere maggiori informazioni per fattibilità, quantità minime e prezzo dedicato. Types of special products not included in the table above. Please contact customer service for more information on feasibility, minimum quantities, and dedicated pricing.			

<sup>1</sup> Altezza custom: Sommare maggiorazione al prezzo della misura di riferimento / Custom height: Add a surcharge to the price of the reference size

<sup>2</sup> Larghezza o Altezza+Larghezza: Sommare maggiorazione al prezzo della misura superiore / Custom width or height+width: Add a surcharge to the price of the next larger size

# PRODOTTI SPECIALI / SPECIAL PRODUCTS

## VERIFICA DELLA MESSA IN BOLLA ORIZZONTALE / VERIFICATION OF HORIZONTAL LEVEL

Controllo del livello del piatto, vasca o piastrelle (in caso di montaggio a filo pavimento)

- "0" (zero) indica il punto più alto
- "-" (meno) indica la pendenza verso il basso

*Check the level of the shower tray, tub, or tiles (in case of floor installation):*

- "0" (zero) indicates the highest point
- "-" (minus) indicates the slope downwards.

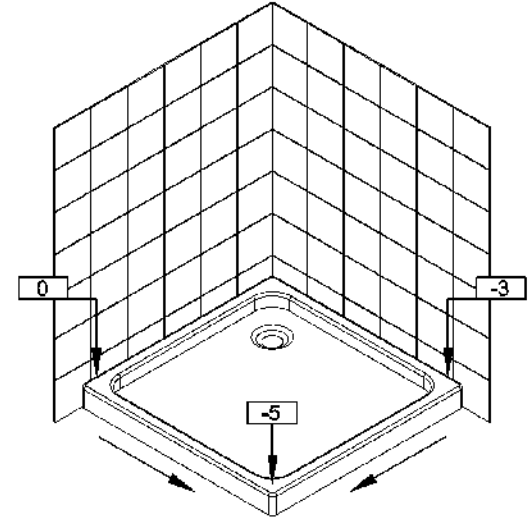

## VERIFICA DELLA MESSA IN BOLLA VERTICALE / VERIFICATION OF PLUMB

Inclinazione della parete muraria

- "0" (zero) il punto zero si trova sempre a terra sul piatto doccia o sul pavimento
- "+" (più) indica l'inclinazione della parete verso l'esterno, riferito all'altezza della Cabina.
- "-" (meno) indica l'inclinazione della parete verso l'interno, riferito all'altezza della cabina.

*Inclination of the masonry wall:*

- "0" (zero) point zero is always on the ground, the shower tray, or floor.
- "+" (plus) indicates the outward inclination of the masonry wall, in reference to the stall height.
- "-" (minus) indicates the inward inclination of the masonry wall, in reference to the stall height.

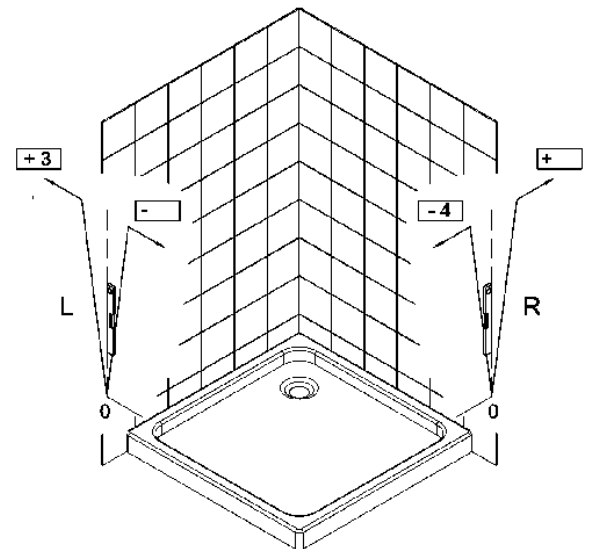

Simbolo per il livello verticale  
*Symbol for vertical level*

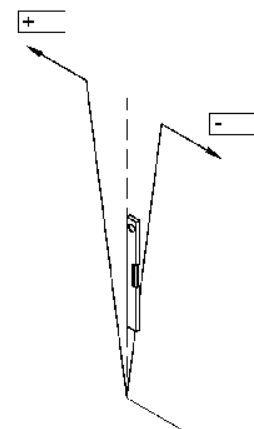

# PRODOTTI SPECIALI / SPECIAL PRODUCTS

## PRESA MISURA PARETE DOCCIA / SHOWER ENCLOSURE MEASUREMENT

MISURE: attenzione, le misure richieste sono sempre relative allo spazio doccia, NON alle misure della cabina doccia

- \_ Piatto doccia misure esterne ed interne.
- \_ In caso di montaggio a filo pavimento segnalare le dimensioni delle fughe.
- \_ Contrassegnare la modalità di montaggio desiderata.

Measurements: attention, the required measurements are always relative to the space of the shower, not to the dimensions of the shower stall.

- \_ Shower tray - external and internal measurements.
- \_ If being installed flush with the floor, indicate the dimensions of the joints.
- \_ Indicate the installation mode desired.

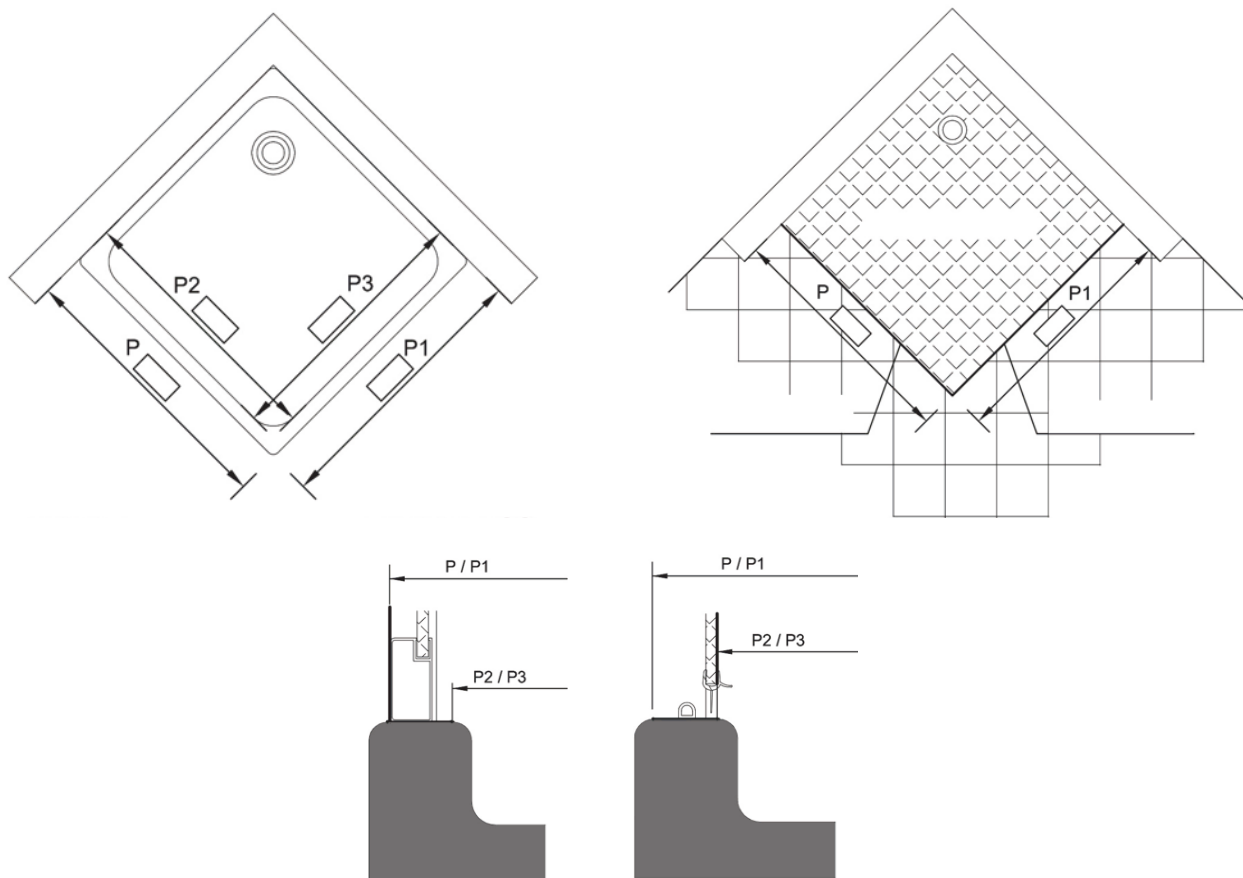

## TAGLI OBLIQUI E SITUAZIONI MANSARDATE / DIAGONAL CUTS AND ATTIC ROOMS

In questi casi è sempre necessario rilevare l'angolo.

A questo scopo collocare il goniometro, appoggiandolo sui due lati, sul muro verticale e sulla pendenza ed annotare semplicemente l'angolo che ne consegue.

In these cases, it is always necessary to measure the angle.  
For this purpose, use a goniometer, resting it on both sides, on the vertical and on the sloping wall, and simply note the resulting angle.

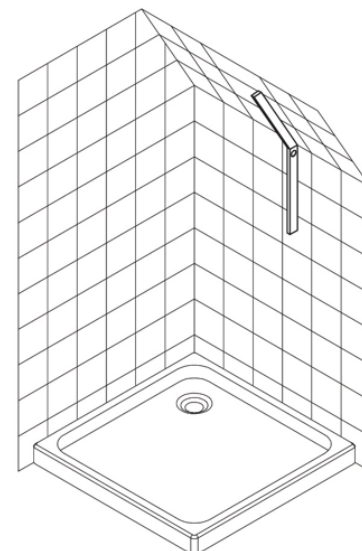

# PRODOTTI SPECIALI / SPECIAL PRODUCTS

MODULO DI DOMANDA DISPONIBILE ONLINE SUL SITO WEB: [www.samo.it/it/prodotti-speciali](http://www.samo.it/it/prodotti-speciali)

**G01a**    Data: \_\_\_\_\_    Offerta:     Ordine:     Cliente: \_\_\_\_\_

Ticket: \_\_\_\_\_    Ref. Cliente: \_\_\_\_\_    Firma Cliente: \_\_\_\_\_  
(per approvazione)

Serie: \_\_\_\_\_    Modello: \_\_\_\_\_    Colore profilo: \_\_\_\_\_

Rif. Cantiere \_\_\_\_\_    Piano terra/ piano 1°/..... )    Vetro: \_\_\_\_\_    Star clean: SI  NO

NOTE: \_\_\_\_\_

N.B. La conferma definitiva del prodotto sarà a cura dell'ufficio clienti. Le misure vanno indicate in mm. Il modulo va compilato in ogni sua parte.

Montaggio su Piatto (C1)

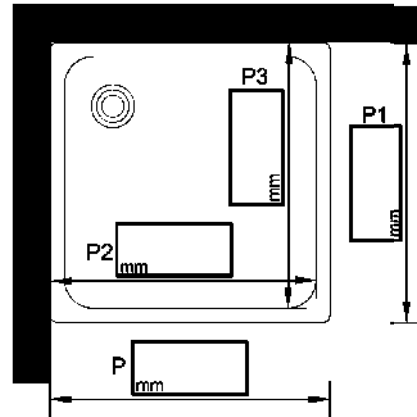
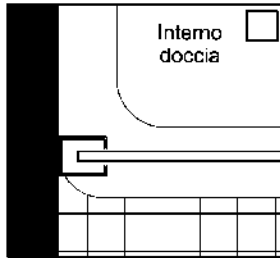

H TOTALE  
mm \_\_\_\_\_

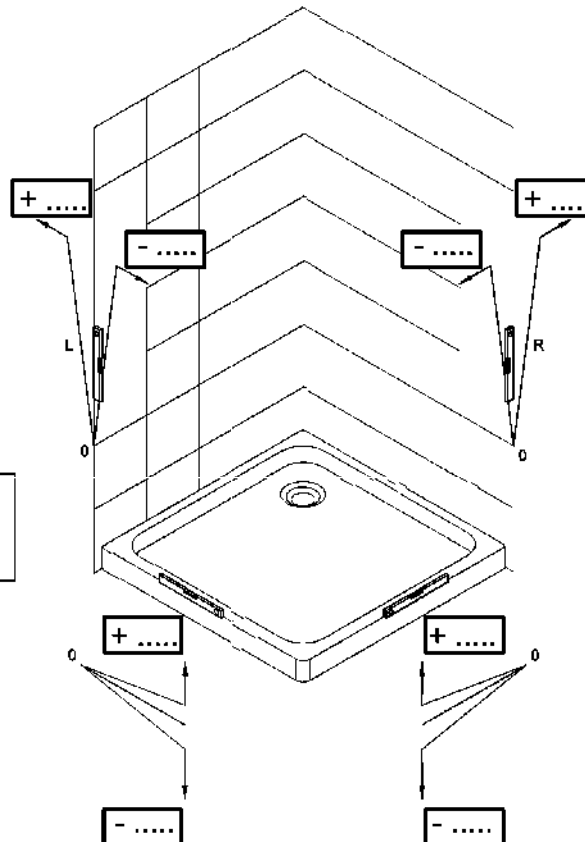

Articolo lato SX  
**B**

Articolo lato DX  
**B**

# PRODOTTI SPECIALI / SPECIAL PRODUCTS

APPLICATION FORM AVAILABLE ONLINE ON THE WEBSITE: [www.samo.it/en/prodotti-speciali](http://www.samo.it/en/prodotti-speciali)

<b>G01a</b>	Date: _____	Offer: <input type="checkbox"/>	Order: <input type="checkbox"/>	Customer: _____
	Ticket: _____	Next of kin: _____	Customer signature: _____ ( for approval )	
	Serie: _____	Model: _____	Profile colour: _____	
	Construction site reference: _____	Ground floor / 1st floor/..... )	Glass: _____	StarClean: YES <input type="checkbox"/> NO <input type="checkbox"/>
Note: _____				
<small>The final confirmation of the product will be prepared by the Customer Service. The measures shall be given in mm. The form must be completed in its entirety.</small>				

Installation on shower tray (C1)

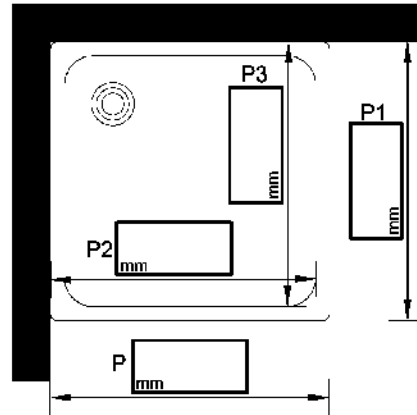
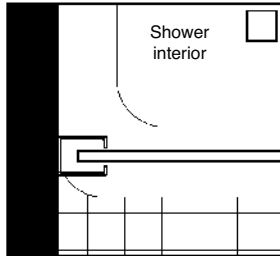

Full H.  
mm \_\_\_\_\_

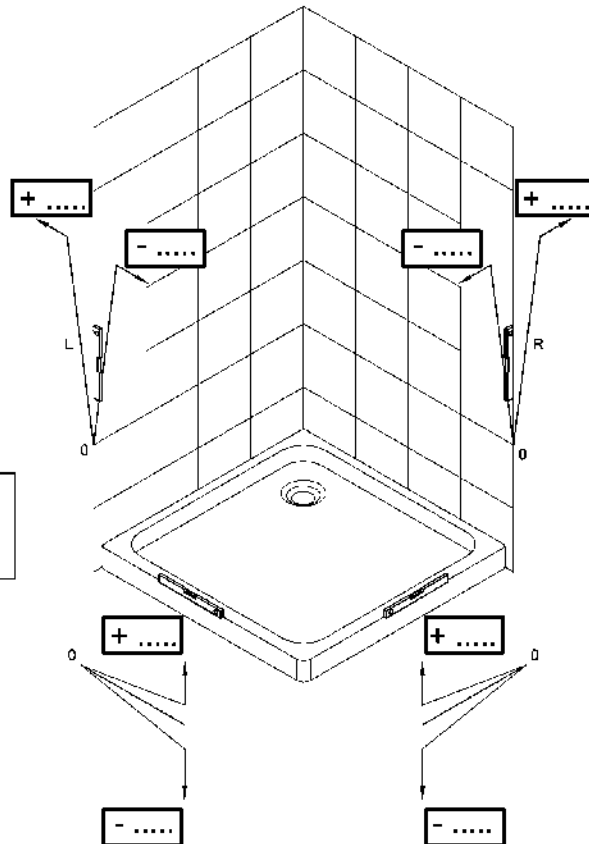

Left side article SX  
**B**

Right side article DX  
**B**

# INFO & SERVIZI / INFO & SERVICE



## **INFO & SERVIZI / INFO & SERVICE**

Forte è l'attenzione che Samo pone verso la possibilità di "modellare" la propria proposta, non solo in termini di prodotto, ma soprattutto come combinazioni prodotto-servizio che favoriscano il passaggio dal concetto classico di "fornitura articolata" ad una più innovativa "sinergia ad alto valore aggiunto", capace di contemplare un'articolazione di servizi strutturata ed al di sopra delle aspettative del mercato.

Nuove tavole per migliorare la realizzazione di prodotti speciali, prodotti per la cura del corpo, per la cura della cabina doccia, per l'installazione, il nuovo portale e-samo, i servizi di installazione e l'ampliamento della garanzia, si aggiungono ai servizi consolidati dei profili di compensazione e dell'area dei ricambi, fornendo molti più strumenti a chi vuole intraprendere con Samo un rapporto di fiducia, professionalità e collaborazione.

*Samo inaugurates a new section about services, opportunities to implement the high added value relationship to strengthen partnerships with various players in the bathroom Furniture chain. Strong is the attention that Samo poses to the possibility of shaping its proposal, not only in terms of product, but primarily as product-service combinations that promote the transition from the classical concept of "articulated supply" to a more innovative "high added value synergy", able to contemplate an organized service set above market expectations. New schemes to improve the delivery of special products, products for body care, care of the shower, for the installation, the new portal e-samo, installation services and warranty extension, in addition to consolidated services like compensation profiles and spare parts area, providing many more tools for those want to take with Samo trust, professionalism and cooperation.*

**PROFILI SPECIALI, DI COMPENSAZIONE E GIUNZIONE / SPECIAL PROFILES, COMPENSATION AND JOINTING**

**SERVIZI PRE E POST-VENDITA / PRE-SALES AND AFTER-SALES SERVICES**

**MATERIALI / MATERIALS**

**STARCLEAN - PULIZIA DEI PRODOTTI / STARCLEAN - PRODUCT CLEANING**

**PULIZIA DEI PRODOTTI / PRODUCT CLEANING**

**E-SAMO WEB SERVICES**

**CONDIZIONI GENERALI / GENERAL CONDITIONS**

# ATTACCHI LATERALI / SIDE ATTACKS

Articolo/Article	Altezza/Height [cm]	Serie/Series	ULU	L96	SAR-L91	ATELIER	DOLCEVITA
<b>ALI-_-_-2000-A</b>	200	Acrux					

## ALI-ULU-2000-A

Per la creazione del codice del profilo speciale bisogna aggiungere la finitura scelta del profilo (es. ULU o SAR, etc.)  
 For the creation of the special profile code, the chosen profile finish must be added (e.g. ULU or SAR, etc.).

### PYXIS

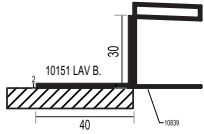

Attacchi laterali / Side attacks

Articolo/Article	Altezza/Height [cm]	Serie/Series	ULU	L96	L91	DOLCEVITA
<b>ALI-_-_-2000-B</b>	200	Pyxis	140,00	140,00	140,00	180,00

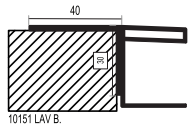

Attacchi laterali / Side attacks

Articolo/Article	Altezza/Height [cm]	Serie/Series	ULU	L96	L91	DOLCEVITA
<b>ALA-_-_-2000-B</b>	200	Pyxis	140,00	140,00	140,00	180,00

### ACRUX

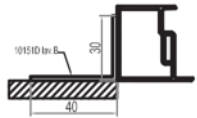

Attacchi laterali / Side attacks

Articolo/Article	Altezza/Height [cm]	Serie/Series	ULU	L96-L91	SAR	ATELIER	DOLCEVITA
<b>ALI-_-_-2000-A</b>	200	Acrux	140,00	140,00	140,00	140,00	180,00

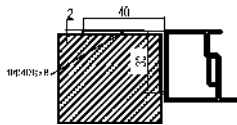

Attacchi laterali / Side attacks

Articolo/Article	Altezza/Height [cm]	Serie/Series	ULU	L96-L91	SAR	ATELIER	DOLCEVITA
<b>ALA-_-_-2000-A</b>	200	Acrux	140,00	140,00	140,00	140,00	180,00

### GRAND POLARIS

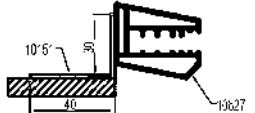

Attacchi laterali / Side attacks

Articolo/Article	Altezza/Height [cm]	Serie/Series	ULU	L96	L91
<b>ALI-_-_-1950-B</b>	195	Grand Polaris	140,00	140,00	140,00

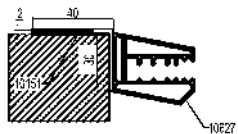

Attacchi laterali / Side attacks

Articolo/Article	Altezza/Height [cm]	Serie/Series	ULU	L96	L91
<b>ALA-_-_-1950-B</b>	195	Grand Polaris	140,00	140,00	140,00

### EUROPA / EUROPA SP

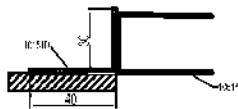

Attacchi laterali / Side attacks

Articolo/Article	Altezza/Height [cm]	Serie/Series	ULU	SAR	L01
<b>ALI-_-_-2000-D</b>	200	Europa	140,00	140,00	90,00
<b>ALI-_-_-1965-D</b>	196.5	Europa SP	140,00	140,00	90,00

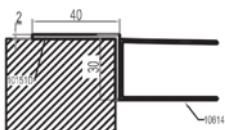

Attacchi laterali / Side attacks

Articolo/Article	Altezza/Height [cm]	Serie/Series	ULU	SAR	L01
<b>ALI-_-_-2000-D</b>	200	Europa	140,00	140,00	90,00
<b>ALI-_-_-1965-D</b>	196.5	Europa SP	140,00	140,00	90,00

# ATTACCHI LATERALI / SIDE ATTACKS

## CEE ART / CEE ART SP



Attacchi laterali / Side attacks

Articolo/Article	Altezza/Height [cm]	Serie/Series	ULU	L96	L91	L01	L95
<b>ALI-_-_-1950-A</b>	195	Cee Art	140,00	140,00	140,00	90,00	140,00
<b>ALI-_-_-1965-A</b>	196.5	Cee Art SP	140,00	140,00	140,00	90,00	140,00

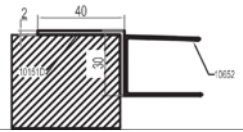

Attacchi laterali / Side attacks

Articolo/Article	Altezza/Height [cm]	Serie/Series	ULU	L96	L91	L01	L95
<b>ALA-_-_-1950-A</b>	195	Cee Art	140,00	140,00	140,00	90,00	140,00
<b>ALA-_-_-1965-A</b>	196.5	Cee Art SP	140,00	140,00	140,00	90,00	140,00

## POLARIS / ALTER

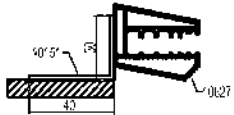

Attacchi laterali / Side attacks

Articolo/Article	Altezza/Height [cm]	Serie/Series	ULU	L96	L91	DOLCEVITA
<b>ALI-_-_-1950-D</b>	195	Polaris / Alter	140,00	140,00	140,00	180,00

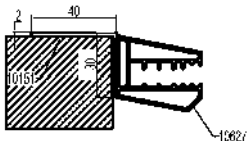

Attacchi laterali / Side attacks

Articolo/Article	Altezza/Height [cm]	Serie/Series	ULU	L96	L91	DOLCEVITA
<b>ALA-_-_-1950-D</b>	195	Polaris / Alter	140,00	140,00	140,00	180,00

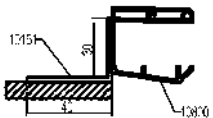

Attacchi laterali / Side attacks

Articolo/Article	Altezza/Height [cm]	Serie/Series	ULU	L96	L91	DOLCEVITA
<b>ALI-_-_-1950-E</b>	195	Polaris / Alter	140,00	140,00	140,00	180,00

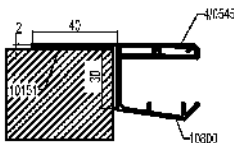

Attacchi laterali / Side attacks

Articolo/Article	Altezza/Height [cm]	Serie/Series	ULU	L96	L91	DOLCEVITA
<b>ALA-_-_-1950-E</b>	195	Polaris / Alter	140,00	140,00	140,00	180,00

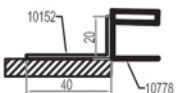

Attacchi laterali / Side attacks

Articolo/Article	Altezza/Height [cm]	Serie/Series	ULU	L96	L91	DOLCEVITA
<b>ALI-_-_-1950-F</b>	195	Polaris / Alter	140,00	140,00	140,00	180,00

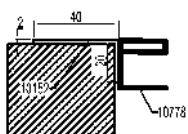

Attacchi laterali / Side attacks

Articolo/Article	Altezza/Height [cm]	Serie/Series	ULU	L96	L91	DOLCEVITA
<b>ALA-_-_-1950-F</b>	195	Polaris / Alter	140,00	140,00	140,00	180,00

**SU MISURA/CUSTOM** [€]

▲▼ Altezza/Height +35,00

# ATTACCHI LATERALI / SIDE ATTACKS

## AMERICA QUATTRO

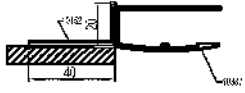

Attacchi laterali / Side attacks

Articolo/Article	Altezza/Height [cm]	Serie/Series	ULU	L96	L91
<b>ALI-_-_-1900-D</b>	190	America Quattro	140,00	140,00	140,00

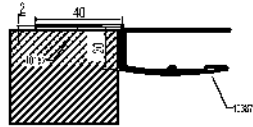

Attacchi laterali / Side attacks

Articolo/Article	Altezza/Height [cm]	Serie/Series	ULU	L96	L91
<b>ALA-_-_-1900-D</b>	190	America Quattro	140,00	140,00	140,00

## AMERICA QUATTRO SP



Attacchi laterali / Side attacks

Articolo/Article	Altezza/Height [cm]	Serie/Series	ULU	L96	L91
<b>ALI-_-_-1900-A</b>	190	America Quattro SP	140,00	140,00	140,00

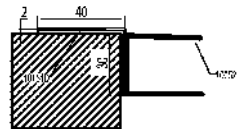

Attacchi laterali / Side attacks

Articolo/Article	Altezza/Height [cm]	Serie/Series	ULU	L96	L91
<b>ALA-_-_-1900-A</b>	190	America Quattro SP	140,00	140,00	140,00

## CIAO

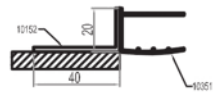

Attacchi laterali / Side attacks

Articolo/Article	Altezza/Height [cm]	Serie/Series	ULU	L01
<b>ALI-L01-1850-E</b>	185	Ciao		90,00

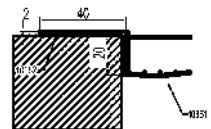

Attacchi laterali / Side attacks

Articolo/Article	Altezza/Height [cm]	Serie/Series	ULU	L01
<b>ALA-L01-1850-E</b>	185	Ciao		90,00

## FLEX

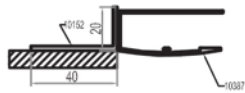

Attacchi laterali / Side attacks

Articolo/Article	Altezza/Height [cm]	Serie/Series	ULU	L01
<b>ALI-_-_-1850-A</b>	185	Flex	140,00	90,00

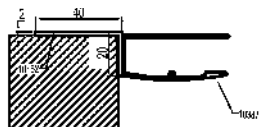

Attacchi laterali / Side attacks

Articolo/Article	Altezza/Height [cm]	Serie/Series	ULU	L01
<b>ALA-_-_-1850-A</b>	185	Flex	140,00	90,00

# PROFILI SPECIALI / SPECIAL PROFILE

## PER TUTTE LE PARETI DOCCIA / FOR ALL THE SHOWER ENCLOSURE SERIES

Attacchi inclinati / Inclined attacks

Articolo/Article	Descrizione/Description	L01	ULU-L96-L91	SAR	ATELIER	DOLCEVITA
<b>Su richiesta/On request*</b>	Attacco inclinato/ <i>Inclined attack</i>	105,00	140,00	140,00	140,00	185,00

\* Contattare l'ufficio clienti per informazioni / *Contact the customer service office for information*

Pareti di solo profilo / *Profile-only walls*

Articolo/Article	Descrizione/Description	L01	ULU-L96-L91	SAR	ATELIER	DOLCEVITA
<b>Su richiesta/On request*</b>	Larghezza <10cm/ <i>Width &lt;10cm</i>	105,00	140,00	140,00	140,00	185,00
<b>Su richiesta/On request*</b>	Larghezza 10cm±20cm/ <i>Width 10cm±20cm</i>	180,00	250,00	250,00	250,00	325,00

\* Contattare l'ufficio clienti per informazioni / *Contact the customer service office for information*

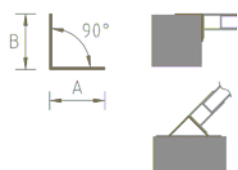

Profilo di congiunzione / *Junction profile*

Articolo/Article	Altezza/Height [cm]	Ingombro Max/Max space [cm]	L01	ULU-L96-L91	SAR	ATELIER	DOLCEVITA
<b>C015</b>	185	4*1	55,00	80,00	80,00	80,00	115,00
<b>C015A</b>	190	4*1	55,00	80,00	80,00	80,00	115,00
<b>C015C</b>	195	4*1	55,00	80,00	80,00	80,00	115,00
<b>C015B</b>	200	4*1	55,00	80,00	80,00	80,00	115,00
<b>C016</b>	185	4*2	55,00	80,00	80,00	80,00	115,00
<b>C016A</b>	190	4*2	55,00	80,00	80,00	80,00	115,00
<b>C016C</b>	195	4*2	55,00	80,00	80,00	80,00	115,00
<b>C016B</b>	200	4*2	55,00	80,00	80,00	80,00	115,00
<b>C017</b>	185	4*3	60,00	90,00	90,00	90,00	120,00
<b>C017A</b>	190	4*3	60,00	90,00	90,00	90,00	120,00
<b>C017C</b>	195	4*3	60,00	90,00	90,00	90,00	120,00
<b>C017B</b>	200	4*3	60,00	90,00	90,00	90,00	120,00
<b>C018</b>	185	4*4	60,00	90,00	90,00	90,00	120,00
<b>C018A</b>	190	4*4	60,00	90,00	90,00	90,00	120,00
<b>C018C</b>	195	4*4	60,00	90,00	90,00	90,00	120,00
<b>C018B</b>	200	4*4	60,00	90,00	90,00	90,00	120,00

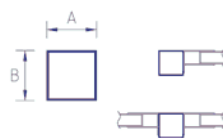

Profilo di compensazione / *Compensating profile*

Articolo/Article	Altezza/Height [cm]	Ingombro Max/Max space [cm]	L01	ULU-L96-L91	SAR	ATELIER	DOLCEVITA
<b>COM41</b>	185	4*1	60,00	90,00	90,00	90,00	120,00
<b>COM41A</b>	190	4*1	60,00	90,00	90,00	90,00	120,00
<b>COM41C</b>	195	4*1	60,00	90,00	90,00	90,00	120,00
<b>COM41B</b>	200	4*1	60,00	90,00	90,00	90,00	120,00
<b>COM42</b>	185	4*2	75,00	115,00	115,00	115,00	150,00
<b>COM42A</b>	190	4*2	75,00	115,00	115,00	115,00	150,00
<b>COM42C</b>	195	4*2	75,00	115,00	115,00	115,00	150,00
<b>COM42B</b>	200	4*2	75,00	115,00	115,00	115,00	150,00
<b>COM43</b>	185	4*3	85,00	130,00	130,00	130,00	165,00
<b>COM43A</b>	190	4*3	85,00	130,00	130,00	130,00	165,00
<b>COM43C</b>	195	4*3	85,00	130,00	130,00	130,00	165,00
<b>COM43B</b>	200	4*3	85,00	130,00	130,00	130,00	165,00
<b>COM44</b>	185	4*4	90,00	135,00	135,00	135,00	180,00
<b>COM44A</b>	190	4*4	90,00	135,00	135,00	135,00	180,00
<b>COM44C</b>	195	4*4	90,00	135,00	135,00	135,00	180,00
<b>COM44B</b>	200	4*4	90,00	135,00	135,00	135,00	180,00

SU MISURA/CUSTOM [€]

▲ ▼ Altezza/Height +35,00

# PROFILI SPECIALI / SPECIAL PROFILE

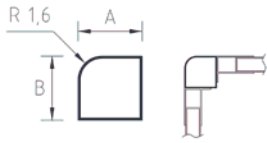

Profilo di congiunzione / Junction profile

Articolo/Article	Altezza/Height [cm]	Ingombro Max/Max space [cm]	L01	ULU	SAR	DOLCEVITA
<b>CO10</b>	185	4.3*4.3	65,00	100,00	100,00	130,00
<b>CO10A</b>	190	4.3*4.3	65,00	100,00	100,00	130,00
<b>COMOC</b>	195	4.3*4.3	65,00	100,00	100,00	130,00
<b>CO10B</b>	200	4.3*4.3	65,00	100,00	100,00	130,00

## AMERICA QUATTRO-AMERICA

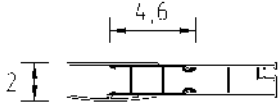

Profilo di compensazione / Compensating profile

Articolo Article	Serie Serie	Altezza Height [cm]	Ingombro Max Max space [cm]	L01	ULU	L96-L91	SAR
<b>COM7</b>	America	185	+4	60,00	90,00	-	90,00
<b>COM7A</b>	America Quattro	190	+4	-	90,00	90,00	-

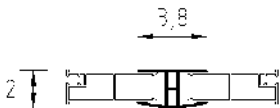
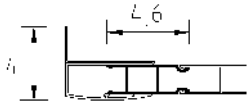

Profilo di congiunzione / Junction profile

Articolo Article	Serie Serie	Altezza Height [cm]	Ingombro Max Max space [cm]	L01	ULU	L96-L91	SAR
<b>CO74</b>	America	185	+2	55,00	85,00	-	85,00
<b>CO74A</b>	America Quattro	190	+2	-	65,00	65,00	-

## PYXIS

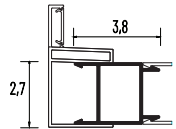

Profilo di compensazione / Compensating profile

Articolo Article	Serie Serie	Altezza Height [cm]	Ingombro Max Max space [cm]	ULU	L96	L91	DOLCEVITA
<b>COM11A</b>	Pyxis	200	+3	90,00	90,00	90,00	120,00

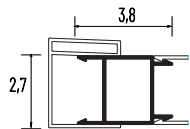

## POLARIS

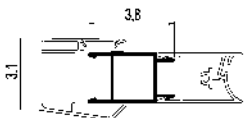

Profilo di compensazione / Compensating profile

Articolo Article	Serie Serie	Altezza Height [cm]	Ingombro Max Max space [cm]	ULU	L96	L91	DOLCEVITA
<b>COM38A*</b>	Polaris	195	+3	90,00	90,00	90,00	120,00

\* Indicato solo per porte con snodo / Suitable only for doors with hinges

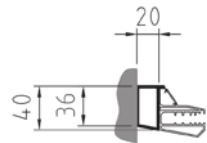

Profilo di compensazione / Compensating profile

Articolo Article	Serie Serie	Altezza Height [cm]	Ingombro Max Max space [cm]	ULU	L96	L91	DOLCEVITA
<b>COM39A</b>	Polaris	195	+2	65,00	65,00	65,00	85,00

## GRAND POLARIS

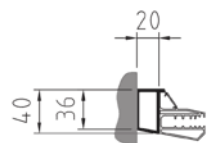

Profilo di compensazione / Compensating profile

Articolo Article	Serie Serie	Altezza Height [cm]	Ingombro Max Max space [cm]	ULU	L96	L91	DOLCEVITA
<b>COM50A</b>	Grand Polaris	195	+2	65,00	65,00	65,00	85,00

# PROFILI SPECIALI / SPECIAL PROFILE

## AMERICA QUATTRO SP-CEE ART-CEE ART SP-EUROPA-EUROPA SP

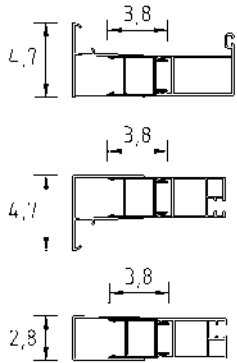

Profilo di compensazione / Compensating profile

Articolo Article	Serie Serie	Altezza Height [cm]	Ingombro Max Max space [cm]	L01	ULU	L96-L91	SAR	L95
<b>COM10A</b>	Europa	200	+3	60,00	90,00	-	90,00	-
<b>COM10B</b>	Europa SP	196.5	+3	60,00	90,00	-	90,00	-
<b>COM10B</b>	Cee Art SP	196.5	+3	-	90,00	90,00	90,00	90,00
<b>COM10C</b>	Cee Art	195	+3	60,00	90,00	90,00	90,00	90,00
<b>COM10D</b>	America Quattro SP	190	+3	-	90,00	90,00	90,00	-

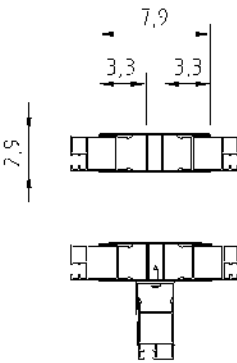

Profilo di congiunzione / Junction profile

Articolo Article	Serie Serie	Altezza Height [cm]	Ingombro Max Max space [cm]	L01	ULU	L96-L91	SAR	L95
<b>CO171A</b>	Europa	200	+3	80,00	90,00	-	90,00	-
<b>CO171B</b>	Europa SP	196.5	+3	80,00	90,00	-	90,00	-
<b>CO171B</b>	Cee Art SP	196.5	+3	-	90,00	90,00	90,00	90,00
<b>CO171C</b>	Cee Art	195	+3	80,00	90,00	90,00	90,00	90,00
<b>CO171D</b>	America Quattro SP	190	+3	-	90,00	90,00	90,00	-

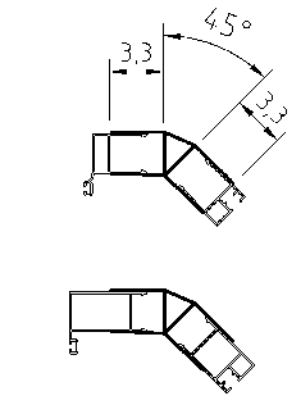

Profilo di congiunzione / Junction profile

Articolo Article	Serie Serie	Altezza Height [cm]	Ingombro Max Max space [cm]	L01	ULU	L96-L91	SAR	L95
<b>CO172A</b>	Europa	200	+3	80,00	90,00	-	90,00	-
<b>CO172B</b>	Europa SP	196.5	+3	80,00	90,00	-	90,00	-
<b>CO172B</b>	Cee Art SP	196.5	+3	-	90,00	90,00	90,00	90,00
<b>CO172C</b>	Cee Art	195	+3	80,00	90,00	90,00	90,00	90,00
<b>CO172D</b>	America Quattro SP	190	+3	-	90,00	90,00	90,00	-

## FLEX

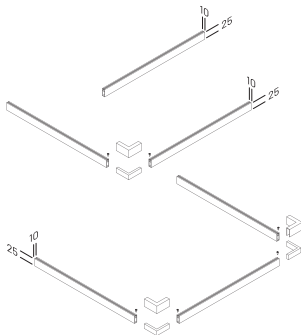

Articolo Article	Serie Serie	Altezza Height [cm]	Ingombro Max Max space [cm]	L01
<b>CO118</b>	Flex	185	91	40,00
<b>CO128</b>	Flex	185	92*92	50,00
<b>CO138</b>	Flex	185	91*91*91	65,00
<b>CO148</b>	Flex	185	120*120*120	75,00
<b>CO158</b>	Flex	185	120	50,00
<b>CO168</b>	Flex	185	120*120	65,00

## POLYSTIRENE

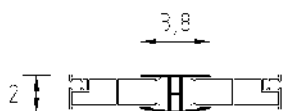

Profilo di giunzione / Junction profile

Articolo Article	Serie Serie	Altezza Height [cm]	Ingombro Max Max space [cm]	L01	ULU	SAR
<b>CO74</b>	-	185	+2	55,00	85,00	85,00

SU MISURA/CUSTOM [€]

▲▼ Altezza/Height +35,00

# PROFILI SPECIALI / SPECIAL PROFILE

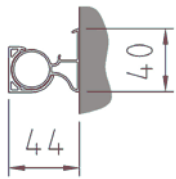

Articolo Article	Altezza Height [cm]	Serie Series	L01	ULU	L96	L91	SAR	ATELIER	DOLCEVITA
COM49A	200	Zenith-Acrux-Open 8	100,00	125,00	125,00	125,00	125,00	125,00	165,00
COM49B	195	Polaris-Grand Polaris	100,00	125,00	125,00	125,00	-	-	165,00
COM49C	190	Alter-America Quattro	100,00	125,00	125,00	125,00	-	-	-
COM49E	185	America-Flex	100,00	125,00	125,00	125,00	125,00	-	-
COM49F	183.5	Flex	100,00	-	-	-	-	-	-
COM49G	160	Pareti Vasca/Bath Screen	85,00	110,00	-	-	-	-	-
COM49H	150	Pareti Vasca/Bath Screen	85,00	110,00	-	-	-	-	-
COM49I	140	Pareti Vasca/Bath Screen	85,00	110,00	-	-	-	-	-
COM49L	135	Pareti Vasca/Bath Screen	85,00	-	-	-	-	-	-
COM49M	100	Flex	70,00	-	-	-	-	-	-

Per Esterno piatto e Metà piatto tenere almeno 50 mm di muro oltre il piatto doccia.  
For Flat exterior and Half plate, maintain at least 50 mm of wall beyond the shower tray

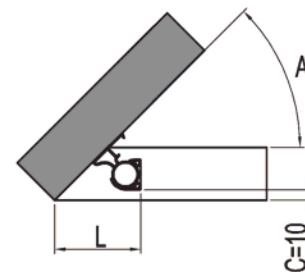
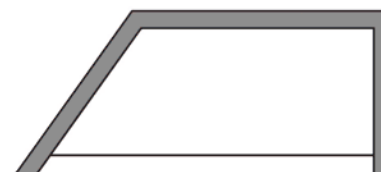
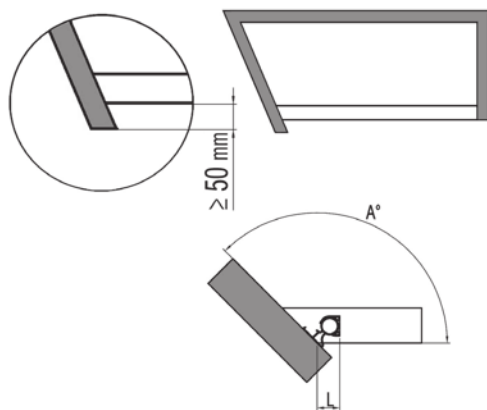

	Esterno piatto Flat exterior	Metà piatto Half plate	Interno piatto Flat interior
Angolo Angle [°]	Larghezza Width [mm]	Larghezza Width [mm]	Larghezza Width [mm]
90°	44	44	44
95°	43	42	41
100°	42	41	39
105°	42	39	36
110°	41	37	34
115°	41	36	31
120°	41	35	29
125°	41	34	27
130°	42	33	25
135°	42	32	22
140°	44	32	20
145°	46	32	18
150°	50	32	15

	Esterno piatto Flat exterior	Metà piatto Half plate	Interno piatto Flat interior
Angolo Angle [°]	Larghezza Width [mm]	Larghezza Width [mm]	Larghezza Width [mm]
25°	116	138	159
30°	99	117	134
35°	87	101	116
40°	78	90	102
45°	71	81	91
50°	66	74	82
55°	61	68	75
60°	57	63	69
65°	54	59	63
70°	52	55	59
75°	49	52	55
80°	47	49	51
85°	46	47	47
90°	44	44	44

# PROFILI SPECIALI / SPECIAL PROFILE

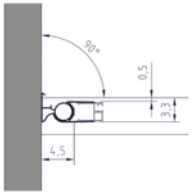

Articolo Article	Altezza Height [cm]	Ingom.Max Max space [cm]	Serie Series	L01	ULU	L96	L91	SAR	ATELIER	DOLCEVITA
COM45A	200		Europa	110,00	145,00	145,00	145,00	145,00	-	-
COM45B	196.5		Europa SP-Cee Art SP	110,00	145,00	145,00	145,00	145,00	145,00	-
COM45C	195		Cee Art	110,00	145,00	145,00	145,00	145,00	145,00	-
COM45D	190		America Quattro SP	95,00	115,00	115,00	115,00	115,00	-	-
COM45E	187.5		Acrux	95,00	115,00	115,00	115,00	-	115,00	-
COM45F	150		B1450	80,00	100,00	-	-	-	-	-
COM45G	140		B1480-B1490	80,00	100,00	-	-	-	-	-

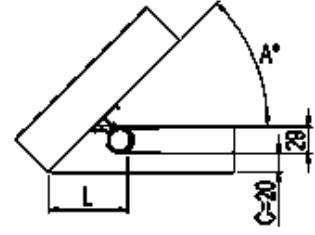
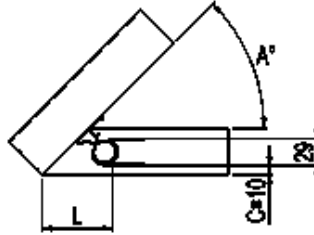
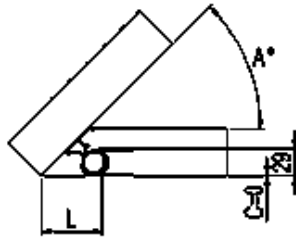

25°±90° C=0	
A [°]	L [mm]
25°	111
30°	94
35°	82
40°	73
45°	66
50°	60
55°	56
60°	52
65°	49
70°	46
75°	44
80°	42
85°	40
90°	39

25°±90° C=10	
A [°]	L [mm]
25°	132
30°	111
35°	96
40°	85
45°	76
50°	69
55°	63
60°	58
65°	53
70°	50
75°	47
80°	44
85°	41
90°	39

25°±90° C=20	
A [°]	L [mm]
25°	154
30°	129
35°	110
40°	97
45°	86
50°	77
55°	70
60°	63
65°	58
70°	53
75°	49
80°	45
85°	42
90°	39

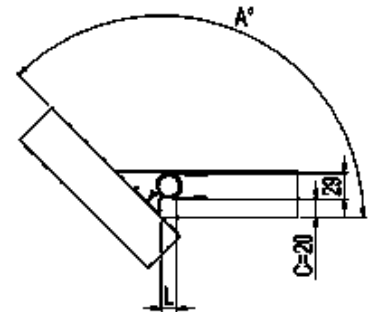
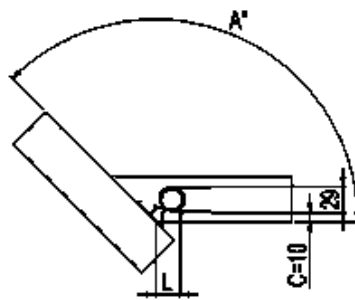
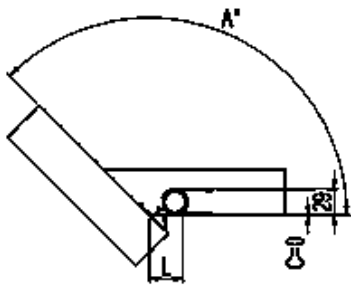

90°±150° C=0	
A [°]	L [mm]
90°	39
95°	38
100°	37
105°	36
110°	36
115°	35
120°	35
125°	36
130°	36
135°	37
140°	39
145°	41
150°	44

90°±150° C=10	
A [°]	L [mm]
90°	39
95°	37
100°	35
105°	34
110°	32
115°	31
120°	30
125°	29
130°	28
135°	27
140°	27
145°	27
150°	27

90°±150° C=20	
A [°]	L [mm]
90°	39
95°	36
100°	33
105°	31
110°	28
115°	26
120°	24
125°	22
130°	19
135°	17
140°	15
145°	12
150°	10

# PROFILI SPECIALI / SPECIAL PROFILE

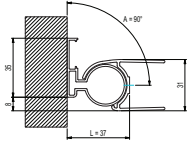

Articolo Article	Altezza Height [cm]	Ingom.Max Max space [cm]	Serie Series	L01	ULU	L96	L91	SAR	ATELIER	DOLCEVITA
COM51A	200	+3	Pyxis	-	150,00	150,00	150,00	-	-	195,00

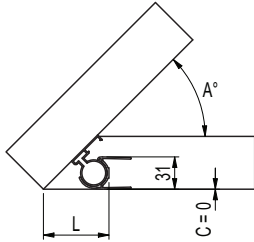

25°+90° C=0		
A [°]	L [mm]	
25°	101	
30°	86	
35°	76	
40°	68	
45°	62	
50°	57	
55°	53	
60°	49	
65°	46	
70°	44	
75°	42	
80°	40	
85°	38	
90°	37	

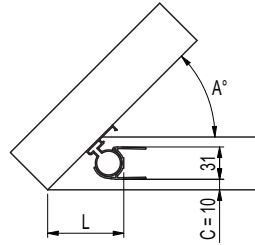

25°+90° C=10		
A [°]	L [mm]	
25°	122	
30°	104	
35°	90	
40°	80	
45°	72	
50°	65	
55°	60	
60°	55	
65°	51	
70°	48	
75°	44	
80°	42	
85°	39	
90°	37	

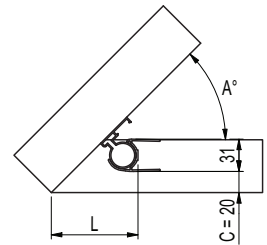

25°+90° C=20		
A [°]	L [mm]	
25°	144	
30°	121	
35°	104	
40°	92	
45°	82	
50°	73	
55°	67	
60°	61	
65°	56	
70°	51	
75°	47	
80°	43	
85°	40	
90°	37	

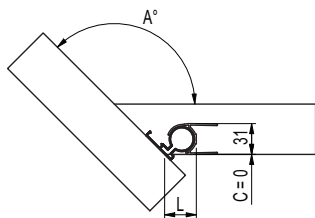

90°+150° C=0		
A [°]	L [mm]	
90°	37	
95°	36	
100°	35	
105°	34	
110°	33	
115°	32	
120°	32	
125°	31	
130°	31	
135°	31	
140°	31	
145°	32	
150°	33	

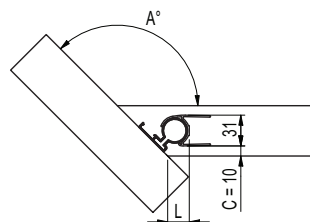

90°+150° C=10		
A [°]	L [mm]	
90°	37	
95°	35	
100°	33	
105°	31	
110°	29	
115°	27	
120°	26	
125°	24	
130°	23	
135°	21	
140°	19	
145°	18	
150°	16	

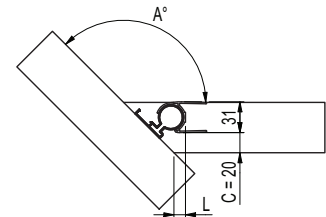

90°+150° C=20		
A [°]	L [mm]	
90°	37	
95°	34	
100°	31	
105°	28	
110°	25	
115°	23	
120°	20	
125°	17	
130°	14	
135°	11	
140°	8	
145°	4	
150°	-1	



# SERVIZI PRE E POST-VENDITA / PRE- AND AFTER-SALES SERVICES

## CENTRI ASSISTENZA / ASSISTANCE CENTRES

Samo dispone in tutta Italia di una rete di Centri Assistenza a pagamento con tariffario convenzionale formata da personale specializzato per installazione, montaggio e manutenzione dei prodotti Samo.

Samo esaudisce le aspettative dei propri clienti, dei professionisti del settore, installatori e strutture di vendita e degli utenti finali, con velocità e precisione per scegliere e mantenere efficienti nel tempo i prodotti Samo e risolvere i quesiti che emergono.

Ogni Centro Assistenza può essere interpellato direttamente dal rivenditore o dall'utilizzatore finale.

Per conoscere il Centro Assistenza più vicino si può interpellare l'agente di zona, oppure consultare il sito [www.samo.it](http://www.samo.it).

*Samo boasts a network of Assistance Centres throughout Italy that provide services at standard prices by specialised personnel for the installation, assembly, and maintenance of Samo products.*

*Samo is proud to meet the expectations of their clients, of sector professionals, installers and sales structures, and end users quickly and accurately to select and maintain Samo products over time and resolve any inquiries that might emerge.*

*Each Assistance Centre can be contacted directly by the retailer or by the end user.*

*To find the Assistance Centre nearest you, contact your local agent or consult the [www.samo.it](http://www.samo.it) website.*



## CONDIZIONI DI FORNITURA / TERMS OF SUPPLY

- A. Le pareti doccia devono trovarsi all'interno del vano di installazione o nelle immediate vicinanze.
  - B. Gli imballi devono essere posti all'interno dello stabile prestabilito per l'installazione.
  - C. La predisposizione e l'allacciamento degli impianti idrico/elettrici sono a cura della committenza. (devono essere idonei alle cabine da installare ed in regola con le normative di legge vigenti).
  - D. Eventuale posizionamento del piatto doccia dovrà essere a cura della committenza (idoneo per forma, dimensioni e posa e congruenti con il tipo di cabina da installare).
  - E. La data di inizio lavori richiesta deve essere comunicata dalla committenza con 10 giorni di anticipo, previa vostra verifica delle condizioni dei locali e della disponibilità del materiale da installare.
  - F. L'acquirente si impegna a garantire la continuità della fase di installazione dei prodotti a partire dalla data comunicata.
  - G. I locali interessati dovranno essere accessibili e sgombri (nella zona specifica) da accessori, sanitari, mobili, torelli, etc. che impediscano l'installazione delle cabine doccia e dotati di presa funzionante da 220 V.
  - H. L'acquirente si impegna a fornire la mappatura completa riguardante la suddivisione delle cabine doccia per piano/camera in fase di acquisto.
  - I. L'acquirente solleva il Centro Assistenza Samo da qualsiasi responsabilità dovuta al danneggiamento di impianti presenti nelle zone di installazione se non anticipatamente comunicato tramite l'invio della mappatura impianti con 10 giorni di anticipo.
  - J. A lavori di installazione ultimati verrà effettuato il controllo dal responsabile dei lavori o da un incaricato da voi scelto che si impegnerà a firmare il Rapporto di Intervento Samo.
  - K. In caso di interventi straordinari non previsti e concordati preventivamente, saranno addebitati, a lavori ultimati, al costo fisso di 50 €/ora per tecnico.
  - L. Le tipologie di offerta per installazione/smontaggio cabine non comprendono lo smaltimento degli imballi o delle cabine obsolete se non preventivamente concordato in fase d'offerta.
  - M. Per foratura su materiali tipo Gres porcellanato, marmo, vetro, verrà applicato un aumento di € 50.
  - N. Le pareti interessate al posizionamento delle cabine devono essere idonee per dimensioni e struttura per l'ancoraggio delle stesse come da istruzioni di montaggio, in caso contrario deve essere comunicato dal responsabile dei lavori con 10 giorni di anticipo.
  - O. In caso di impossibilità di montaggio, verrà addebitata l'uscita di € 110.
- 
- A. *The shower enclosure must be located within the installation space or in the immediate vicinity.*
  - B. *The packages must be positioned within the building designated for installation.*
  - C. *The configuration and hook-ups of the plumbing/electrical systems are to be arranged by and charged to the client. (they must be suitable for the shower to be installed and in compliance with existing building codes)*
  - D. *The installation of the shower tray must be done by the client (suitable in shape, size, and installation and in keeping with the type of shower stall to be installed).*
  - E. *The requested date to start work will be communicated by the client 10 days in advance, upon verification of the conditions of the installation site and the availability of the materials to be installed.*
  - F. *The buyer hereby agrees to guarantee the continuity of the installation of products beginning with the date communicated.*
  - G. *The installation site must be accessible and free of clutter (in the specific zone) and accessories, bathroom fixtures, furniture, special tiles, etc. that obstruct the installation of the shower enclosure and equipped with a functioning 220 V outlet.*
  - H. *The buyer hereby agrees to provide the complete floor plan for the subdivision of the shower enclosure for the floor/room during the purchase.*
  - I. *The buyer relieves the Samo Assistance Centre for any and all responsibility due to the damage of existing systems in the installation zone if not communicated in advance by sending the executive drawings and system diagrams 10 days in advance.*
  - J. *Once the installation has been completed, the works manager or designated technician selected by the client will inspect and sign the Samo Intervention Report.*
  - K. *In case of extraordinary interventions not foreseen and agreed upon beforehand, the same will be invoiced once the works are complete at a fixed cost of 60 €/hour per technician.*
  - L. *The types of offers for the installation/disassembly of shower enclosure do not include the disposal of the packaging and the old shower enclosure if not agreed upon beforehand during the estimate phase.*
  - M. *For boring holes into materials like porcelain stoneware, marble, glass, a surcharge of € 80 will be applied.*
  - N. *The walls involved in the positioning of the shower enclosure must be suitable in terms of dimensions and anchoring structures, as indicated in the assembly instructions; otherwise, the installation manager must be notified 10 days in advance.*
  - O. *If the installation is impossible, the transfer costs will be charged 160 €.*

# SERVIZI PRE E POST-VENDITA / PRE- AND AFTER-SALES SERVICES

Codice Code	Operazione Intervention	Descrizione Description		
KU4000.01	Rilevazione Misure <i>Installation of shower enclosure on site</i>	Uscita e rilevazione delle misure <i>Measures detection on site</i>		80,00
KU7000.01	Montaggio parete doccia <i>Installation of shower enclosure on site</i>	Uscita e installazione 1 parete <i>Installation 1 side</i>	0+100 cm	145,00
KU7000.11	Montaggio parete doccia <i>Installation of shower enclosure on site</i>	Uscita e installazione 1 parete <i>Installation 1 side</i>	100+200 cm	200,00
KU7000.03	Montaggio parete doccia <i>Installation of shower enclosure on site</i>	Uscita e installazione 2 parete <i>Installation 2 side</i>	0+100 cm	180,00
KU7000.33	Montaggio parete doccia <i>Installation of shower enclosure on site</i>	Uscita e installazione 2 parete <i>Installation 2 side</i>	100+200 cm	240,00
KU7000.10	Montaggio parete doccia <i>Installation of shower enclosure on site</i>	Uscita e installazione 3 parete <i>Installation 3 side</i>	0+100 cm	250,00
KU7000.20	Montaggio parete doccia <i>Installation of shower enclosure on site</i>	Uscita e installazione 3 parete <i>Installation 3 side</i>	100+200 cm	290,00
KU7000.09	Montaggio piatto doccia <i>Installation of shower tray</i>	Uscita e installazione <i>Installation of shower enclosure on site</i>		120,00
KU7000.22	Montaggio colonna doccia <i>Installation of shower column</i>	Uscita e installazione colonne <i>Installation of shower column on site</i>		-
<p>Servizi Omnicomprensivi nel raggio di 30 Km dalla sede del Centro Assistenza Scelto. <i>All-inclusive Services within a radius of 30 km from the location of the Assistance Centre selected</i></p>				
<p>Interventi straordinari non previsti e concordati preventivamente *K <i>Extraordinary interventions not foreseen and agreed upon beforehand *K</i></p>			<p>Costo fisso per 1 ora <i>Fixed Fee for 1 hour</i></p>	
<p>Per foratura su materiali tipo Gres porcellanato, marmo, vetro *M <i>For boring holes into materials like porcelain stoneware, marble, glass *M</i></p>			<p>aumento di <i>Increase of</i></p>	
<p>Uscita a vuoto per l'impossibilità di montaggio *O <i>Vain transfer caused by an impossible installation *O</i></p>			<p>addebito dell'uscita <i>Fixed Fee for the transfer</i></p>	

\* Vedi Condizioni di fornitura

N.B. Servizi da concordare con i Centri Assistenza (i prezzi sono netti (senza IVA) ed indicativi, espressi in €).

\* See Supply Conditions

N.B. Services to be arranged with the Service Centers (prices are net (excluding VAT) and indicative, expressed in €).

## SERVIZI EROGATI / SERVICES PROVIDED

### > Assistenza pre-installazione

Rilevazione misure  
Personalizzazioni grafiche delle cabine doccia  
Soluzioni Speciali

### > Pre-installation Assistance

Measurement survey  
Custom graphic designs for shower enclosures  
Special solutions

### > Assistenza durante l'installazione

Smontaggio cabine doccia esistenti  
Identificazione e distribuzione imballi  
Montaggio nuove cabine doccia  
Smaltimento imballi cabine doccia installate  
Smaltimento cabine doccia sostituite  
Primo avviamento

### > Assistance during Installation

Dismantling of existing shower enclosures  
Identification and distribution of packaging  
Installation of new shower enclosures  
Disposal of packaging from installed shower enclosures  
Disposal of replaced shower enclosures  
Initial start-up

### > Assistenza POST-installazione

Manutenzione ordinaria  
Manutenzione straordinaria  
Fornitura ricambi

### > Post-installation Assistance

Routine maintenance  
Extraordinary maintenance  
Supply of spare parts

# MATERIALI / MATERIALS

## ALLUMINIO / ALUMINIUM

I profili di alluminio sono realizzati con materiale primario di altissima qualità. L'alluminio con elevata resistenza alla corrosione è un materiale in grado di tradurre idee e progetti grazie all'estrusione che si ottiene tramite matrici progettate dall'Area Prodotto samo e di proprietà esclusiva samo. Ogni singolo profilo è preventivamente tagliato e forato, permettendo così ai successivi trattamenti di coprire ogni parte del pezzo, garantendo una qualità duratura nel tempo. La verniciatura viene effettuata attraverso gli impianti tecnologici samo; ogni profilo subisce un pretrattamento di sgrassaggio e fosforomatazione prima di essere verniciato con polveri epossidiche le quali, applicate elettrostaticamente su tutta la superficie del profilo, polimerizzano formando uno strato resistente ed inalterabile nel tempo. Brillantatura e satinatura sono ottenute a mezzo di processi chimici preceduti da accurata spazzolatura dei profili per renderli resistenti e duraturi nel tempo.

*The aluminium profiles are made with the highest raw materials quality. The aluminium, which is highly resistant to corrosion, is suitable to realise ideas and designs by means of extrusion through dies, projected by samo's internal engineering department and with the exclusive ownership. Every single profile is beforehand cut and drilled allowing the following working processes to completely cover every part and guaranteeing his quality over the time. The painting is performed by samo technologic plants and every profile is degreased and phosphoromated in advance before to be painted with epoxy powders that electrostatically applied on the complete profile surface performing a perfect polymerisation with a very resistant coat inalterable over the time. The buffing and the sanitising operations are performed through a chemical processes with a previous and accurate profiles brushing to make them resistant and immutable over the time.*

## ACCIAIO INOSSIDABILE / STEINLESS STEEL

Non arrugginisce. Negli ambienti naturali, l'ossidazione del cromo presente nell'acciaio inossidabile (nota anche come passivazione) forma sulla superficie un film protettivo estremamente sottile di ossidi e idrossidi, che previene la corrosione e la ruggine. L'acciaio inossidabile utilizzato da Samo è l'AISI 304 (X8CrNi1910 EN 10088-1). L'AISI 304 è un acciaio inossidabile con un alto contenuto di cromo nella struttura austenitica, che è l'elemento fondamentale della passivazione protettiva naturale. Proprietà principali dell'AISI 304: Eccellente resistenza alla corrosione e alla ruggine: L'AISI 304 è noto per la sua capacità di resistere efficacemente alla corrosione e alla ruggine. Lavorabilità: Può essere facilmente lavorato e modellato. Igiene: L'AISI 304 è facile da pulire e possiede un buon coefficiente di igiene. Non magnetico: Nella sua stato completamente ricotto, non è magnetico. Proprio a causa di queste caratteristiche, l'acciaio inossidabile AISI 304 è ampiamente utilizzato per la produzione di articoli per la casa (pentole e posate) e per arredi.

*It does not rust. In natural environments, the oxidation of chromium restrained in the stainless steel (otherwise known as passivation) forms on the surface an extremely thin protective film of oxides and hydroxides, that prevents corrosion and rust. The stainless steel used by samo is AISI304 (X8CrNi1910 EN 10088-1). The AISI304 is a stainless steel with an high chromium content in the austenitic structure, that is the basic element of the natural protective passivation. AISI304 main properties: it has excellent resistance to corrosion and rust, it can be processed, it is easily cleaned and has a good coefficient of hygiene, in complete annealing it is not magnetized. Precisely because of these characteristics, the AISI304 stainless steel is mostly used for the production of household items (pots and cutlery) and furnishings.*

## OTTONE / BRASS

È una lega rame-zinco, che presenta notevoli caratteristiche di lavorabilità sia a caldo che a freddo. Viene infatti utilizzata per la produzione di barre e trafilati oppure per particolari lavorati. Grazie alla sua ottima predisposizione alla cromatura, garantisce un prodotto di qualità costante nel tempo.

*a copper-zinc alloy, which presents a highly possibility of hot malleability in hot and warm conditions. In fact it is used for rods, drawn and particular wroughts. The brass, thanks to its aptitude to chromium, grants a longlasting quality.*

## POLYSTYRENE

È all'origine granulato. Scaldandosi ad alta temperatura con un impianto di estrusione si crea un pannello robusto, leggero e con un alto indice di resistenza alla flessione. L'impianto di estrusione è dotato di cilindri su cui sono incisi vari decori samo che s'imprimono sul pannello.

*the original raw material is in granular form. When heated at a high temperature through an extrusion system, it creates a panel with a high level of flexion resistance. The extrusion plant is provided with cylinders that are engraved with several exclusive samo decorations.*

## STONEFIT-STONE

È un materiale composito, formato da cariche minerali naturali e resina. È rivestito da un coating ad effetto estetico opaco. Questo rivestimento abbina ottime caratteristiche di resistenza a completa ripristinabilità della superficie. Tale prodotto è realizzato con materiali tecnologicamente all'avanguardia e dall'elevato impatto estetico: l'alta capacità di resistenza ai graffi e all'abrasione ne permette l'uso quotidiano e garantisce nel tempo la finitura opaca originale, caratteristica distintiva di STONEFIT, può essere riparato da danneggiamenti superficiali, quali graffi o macchie ostinate, riportando la superficie alla bellezza originale. Si consiglia l'impiego di detergenti in gel o abrasivi e spugna abrasiva tipo Scotch Brite®. Alcune sostanze chimiche possono danneggiare la superficie del piatto doccia STONEFIT: si sconsiglia quindi l'uso di acidi e basi forti (acido cloridrico, soda caustica), chetoni (acetone), solventi clorurati (trielina) e prodotto usati nel settore della verniciatura.

*is a composite material, made up of natural mineral aggregates and resin. It is faced with a coating with a matt aesthetic effect. This coating combines excellent resistance with the complete restorability of the surface. This product is made using technologically avant-garde products with high aesthetic impact: its high resistance to scratches and abrasion means that it can be used every day and guarantees STONEFIT's original matt finish, its distinctive feature; any surface damage, such as scratches or obstinate stains, can be repaired with the return of the surface to its original beauty. The use of gel or abrasive detergents with sponges of the Scotch Brite® type is recommended. Some chemicals can damage the surface of the STONEFIT shower tray: we advise against the use of strong acids or alkalis (hydrochloric acid, caustic soda), ketones (acetone), chlorinated solvents (trichlorethylene) and products used in the painting sector.*

## MATERIALE ACRILICO / ACRILIC

È leggero, con superficie sempre lucida e brillante con colori inalterati ed un altissimo grado di isolamento termico. Il materiale viene lavorato con un particolare procedimento di stampaggio a caldo per dare forma al prodotto con impianti di termoformatura all'interno degli stabilimenti samo. Il prodotto è poi rinforzato con una speciale resina di poliestere e vetroresina che lo rende resistente e durevole nel tempo.

*it is a light material which surface always remains shiny and glossy, with unalterable colours and with a very high level of thermic insulation. The material undergoes to a particular warm moulding process in samo factories to obtain the product shape with special thermoforming plants. The product is then reinforced with a special polyester and fibreglass resin that makes it durable and long-lasting.*

## ELEMENTI DI FISSAGGIO E RACCORDO / FIXING AND CONNECTING ELEMENTS

sono studiati e realizzati nei materiali più adatti per garantire durata e qualità (acciaio, nylon, abs, teflon, ottone, zama). Sistemi di scorrimento e guide speciali sono garantite per una perfetta chiusura e tenuta d'acqua.

*all the fixing and connecting elements are projected and realised from materials which guarantee long life and good quality (stainless steel, nylon, ABS, Teflon, brass...). Special guides and sliding systems guarantee a perfect closure and water proofing.*

# VETRO TEMPERATO / TEMPERED GLASS

## VETRO / GLASS



Viene ottenuto per indurimento tramite trattamento termico. Il vetro, prima del processo di tempra, va tagliato rispettando le dimensioni richieste e vanno eseguite tutte le necessarie lavorazioni come la levigatura degli spigoli, le forature e le svasature.

Il vetro viene poi posto su un tavolo a rulli sui quali scorre all'interno di un forno, dove viene opportunamente portato alla temperatura di tempra di 640 °C ed eventualmente viene curvato. Immediatamente all'uscita del forno il vetro viene bruscamente raffreddato da getti di aria fredda ad alta pressione, raffreddando così gli strati superficiali causandone l'indurimento ed il conseguente irrigidimento, mentre la parte interna rimane calda più a lungo. Il successivo raffreddamento della parte interna produce uno sforzo di compressione sulla superficie del vetro, bilanciato da tensioni distensive in trazione nella parte interna. La formazione di questo stato permanente di tensione causa un assorbimento di energia elastica da parte del vetro; quando un vetro temprato si rompe, l'energia immagazzinata viene liberata sotto forma di energia superficiale e per tale motivo alla rottura si formano frammenti piccoli e non taglienti, al contrario di quanto si verifica quando si rompe di un vetro ordinario dove si formano grandi frammenti, anche lanceolati, taglienti e molto pericolosi.

Per questa ragione il vetro temprato è considerato "vetro di sicurezza" e questa caratteristica è ampiamente sfruttata nell'industria automobilistica, dove viene impiegato per realizzare i finestrini laterali delle automobili, ed in generale in tutte quelle applicazioni dove i frammenti del vetro infranto potrebbero colpire delle persone, ad esempio nelle porte in vetro nelle applicazioni strutturali e nelle zone parapetto.

In alcune situazioni però si possono riscontrare problemi di sicurezza a causa della tendenza del vetro temprato di frantumarsi completamente a seguito di urti. È pertanto necessario che la lastra in vetro venga maneggiata con molta cura.

Se dovesse essere necessario appoggiare il vetro al pavimento va fatto con molta cautela, evitando di appoggiarlo sugli spigoli, ma posandolo delicatamente su tutta la lunghezza del lato. È inoltre indispensabile interporre uno strato morbido fra il vetro ed il pavimento (per esempio il cartone dell'imbollo).

*Tempered glass is obtained by hardening through heat treatment.*

*Glass before tempering process, should be cut according to the size required and be performed with all the necessary processing such as smoothing edges, holes and countersink. Glass is then placed on a roller on which slides in an oven, where it is properly led to the hardening temperature of 640 °C and possibly is curved.*

*Immediately at the furnace exit glass is suddenly cooled by blasts of cold air at high pressure, thus cooling the surface layers lead to hardening, while the inside stays longer hot. The subsequent cooling of the interior produces a compressive force on the glass surface, balanced by stretching tensions in traction on the inside.*

*Formation of this permanent state of tension is due to absorption of elastic energy by glass; when tempered glass breaks, the stored energy is released in the form of surface energy and therefore formed small and not sharp pieces, contrary to what occurs when an ordinary glass breaks: it forms larger, even lanceolate, sharp and very dangerous fragments. For this reason, tempered glass is considered "safety glass" and this feature is widely used in the automotive industry, where it is used to make the side windows of cars and generally in all applications where the fragments of broken glass could hit people, such as doors and glass in structural applications in the parapet areas. In some situations, however, you may encounter security problems because of the tendency of tempered glass to shatter completely by shocks. It is therefore necessary that the glass panel has to be handled with care. If you have to put glass panel on the floor should be done with care to avoid placing it on the edges, but laying it gently along the entire length of the side. It is also essential to interpose a soft layer between the glass and the floor (eg cardboard packaging).*



## TRATTAMENTO ANTICALCARE / LIMESCALE TREATMENT

- > StarClean è solo samo: l'azienda ha integrato l'esclusivo trattamento nel proprio processo produttivo ottimizzando risultati in termini di qualità prezzo.
- > StarClean è specifico per vetri di cabine doccia: agisce sulle molecole di silicio contenute nel vetro.
- > StarClean è sicuro: la tecnologia adottata garantisce sempre l'ottima performance del trattamento effettuato.
- > StarClean è idrorepellente: è applicato su ambedue le superfici del pannello; l'acqua scivola via e rende le operazioni di pulizia molto più semplici ed efficaci; con una semplice asciugatura subito dopo l'utilizzo si evitano formazioni di aloni o macchie.
- > StarClean NON è autopulente.
- > StarClean è anticalcare: l'acqua, scivolando via, riduce notevolmente la formazione di calcare; le eventuali tracce rimanenti sono facili da togliere poiché non riescono ad aderire alla superficie del vetro.
- > StarClean è antigraffio: il trattamento rende le superfici del vetro più resistenti ai graffi.
- > StarClean è resistente agli urti: il trattamento rende le superfici del vetro più resistenti agli urti.
- > StarClean è più brillante: il trattamento rende le superfici del vetro più brillanti.
- > StarClean è standard oppure optional: è così richiesto che è già standard su molte serie di box doccia. samo comunque è in grado di offrire StarClean come optional anche nelle altre gamme di prodotto per rendere una scelta conveniente.
- > StarClean è personalizzabile: ha la possibilità di personalizzazione con marchio. Il marchio diventa visibile solo durante l'utilizzo del box doccia (come immagine PERSONALIZZAZIONE).
- > StarClean is only by Samo: we have implemented the treatment as a standard procedure in our manufacturing process.
- > StarClean is specifically for glass shower enclosures: acting permanently on the molecules of silica contained in the glass.
- > StarClean is safe: the performance of the treatment is always guaranteed.
- > StarClean is NOT self-cleaning.
- > StarClean is waterproof: is applied on both glass panel sides; the water flows away and makes cleaning easier. With just a wipe immediately after taking a shower is easy to prevent marks and stains.
- > StarClean is lime scale free: thanks to the treatment the water flows doesn't leave drops hanging on the surface leaving scale stains.
- > StarClean is scratch free: the treatment make the surface virtually anti scratch.
- > StarClean is crash resistat: the treatment make the surface tougher.
- > StarClean is more shining: the treatment make the surface to shine more than normal glass.
- > StarClean is standard or optional: due to its popularity is already standard in most of shower enclosure series. Where is not SAMO gives you the possibility to choose.
- > StarClean is branded: we can inprint your brand or name and it will appear only when the shower is in use.

# PULIZIA DEI PRODOTTI / PRODUCT CLEANING

## PREMESSA / INTRODUCTION

Poiché nessun materiale è perfettamente resistente a qualsiasi agente pulente che normalmente si trova in commercio, la NON OSSERVANZA delle seguenti istruzioni può essere oggetto di DECADIMENTO della GARANZIA dei Prodotti Samo.

*As no material is perfectly resistant to any cleaning agent found in stores, NOT FOLLOWING the instructions below may be cause for the INVALIDATION of the Samo Products WARRANTY.*

## AVVERTENZE GENERALI / GENERAL WARNINGS

- > LEGGERE attentamente le etichette dei prodotti detergenti che utilizzerete per la pulizia e la cura delle cabine doccia Samo.
- > NON USARE prodotti che riportano etichette non chiare o incomplete.
- > CONSERVARE per qualche mese le confezioni dei prodotti che utilizzate per eventuali verifiche e/o contestazioni.
  
- > *READ the labels on the product you will be using to clean and care for your Samo shower enclosure carefully.*
- > *NEVER USE products with labels that are not clear or may be incomplete.*
- > *KEEP for a few months the package of the product you used for any potential verification and/or complaints.*

## MODALITÀ DI SCELTA DEI PRODOTTI DETERGENTI / HOW TO CHOOSE YOUR DETERGENT PRODUCTS

### > NON USARE i prodotti di seguito indicati

- a) Prodotti Corrosivi, quali prodotti a base di Cloro (Ipocloriti e similari quali i candeggianti).
- b) Prodotti a base di Ossigeno Attivo (ad esempio i Perborati).
- c) Prodotti a base Acida (quali Acido Cloridrico (muriatico), Acido Nitrico o Nitrati, Acido Fluoridrico o Fluoruri).
- d) Prodotti a base di Soda e, in generale, prodotti caratterizzati da valori di pH inferiori a 6 e maggiori di 8.
- e) Prodotti abrasivi e/o in polvere poiché possono danneggiare meccanicamente ed irrimediabilmente la cabina doccia.

### > USARE i prodotti di seguito indicati

- a) Prodotti detergenti del tipo delicato, contenenti esclusivamente tensioattivi, anche a base di Fosfati, caratterizzati da valori di pH compresi fra 6 ed 8.
- b) Nel caso di incrostazioni dovute alla presenza di acque dure, è consigliabile l'uso di prodotti a base di aceto con valori di pH vicino a 5.

In questo caso leggere attentamente le istruzioni di seguito descritte.

- Procedere alle operazioni di pulizia non appena possibile e comunque dopo l'uso della cabina doccia; ciò allo scopo di evitare il formarsi di incrostazioni ed indurimenti dello sporco.
- Utilizzare sempre acqua tiepida e spugne delicate o panni morbidi.
- Risciacquare sempre con acqua tiepida.
- Asciugare le parti metalliche sempre con un panno morbido (ad esempio in microfibra).

### > NEVER USE the products indicated below

- a) *Corrosive products, like products containing Chlorine (hypochlorites or similar products, like bleach).*
- b) *Products containing Active Oxygen (for example, Perborates).*
- c) *Products containing Acid (like Hydrochloric Acid (muriatic) Nitric Acid or Nitrates, Hydrofluoric Acid or Fluorides).*
- d) *Products containing Soda and, in general, products with pH values less than 6 and greater than 8.*
- e) *Abrasive products and/or powders, as they can mechanically and irremediably damage the shower enclosure.*

### > USE the products indicated below

- a) *Delicate detergent products containing only surfactants, or even containing Phosphates, characterised by pH values between 6 and 8.*
- b) *In case of lime scales caused by hard water, it is advisable to use vinegar-based products with pH values of about 5.*

*In this case, read the instructions below carefully.*

- *Proceed with cleaning as soon as possible and, in any case, soon after using the shower; prompt cleaning helps to prevent the formation of lime scales and grime.*
- *Always use warm water and delicate sponges or soft cloths.*
- *Always rinse with warm water.*
- *Always dry metallic parts with a soft cloth (for example, in microfiber).*

## NOTA IMPORTANTE / IMPORTANT

Dopo l'uso dei detergenti e l'asciugatura della cabina doccia, si raccomanda di far circolare aria fresca(\*) nell'ambiente in cui è posizionata la cabina doccia, anche e soprattutto all'interno della cabina doccia stessa; ciò allo scopo di permettere al materiale di mantenere un buon grado di "autoprotezione" nei confronti di fenomeni di ossidazione. Questo è particolarmente importante nel caso di cabine doccia "chiuse".

*After using detergents and drying the shower enclosure, it is recommended that you allow fresh air to circulate in the room where the shower enclosure is installed, even and above all inside the shower enclosure itself; this helps to prevent the materials from being subjected to oxidation phenomena. This is particularly important in the case of "closed" shower enclosures.*

(\*) Per aria fresca non si intende aria fredda ma aria non viziata.

(\*) *By fresh air, we do not mean cold air but rather non-stale air.*



# E-MAIL SAMO WEB SERVICES

## DISPONIBILITÀ DEGLI ARTICOLI / AVAILABILITY OF ITEMS



Inviare email SENZA OGGETTO a: **giacenza-it@samo.it**

Nel corpo della mail inserire codice articolo seguito dal ; (punto e virgola)

vedi esempio seguente: **B8822ULUTR/DX;**

Per conoscere la disponibilità di altre varianti articolo (FINITURE) basterà aggiungere \* (asterisco)

vedi esempio seguente: **B8822\*;**

Dopo l'invio riceverete un'email di risposta con gli ARTICOLI E LE QUANTITÀ. oppure la dicitura nessun articolo trovato

*Send an email without a subject to: **giacenza-it@samo.it***

*In the body of the email, insert the article code followed by a semicolon (;).*

*Example: **B8822ULUTR/DX;***

*To check the availability of other article variants (FINISHES), simply add an asterisk (\*) to the article code.*

*Example: **B8822\*;***

*After sending the email, you will receive a reply with the ARTICLES AND QUANTITIES or a message saying no article found.*

## STATO DEGLI ORDINI ON-LINE / STATUS OF ORDERS ONLINE

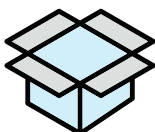

Inviare email SENZA OGGETTO a: **status@samo.it**

Nel corpo della mail inserire il numero di conferma d'ordine seguito dal ; (punto e virgola)

vedi esempio seguente: **20068886;**

Riceverete una email di risposta con un allegato contenente lo stato avanzamento del vostro ordine.

Nel caso fosse stato spedito, sarà presente anche il numero di BOLLA.

*Send an email WITHOUT A SUBJECT to: **status@samo.it***

*In the body of the email, enter the order confirmation number followed by a semicolon (;).*

*Example: **20068886;***

*You will receive a reply email with an attachment containing the progress status of your order. If the order has been shipped, the delivery Note number will also be included.*

# PORTAL SAMO WEB SERVICES



Per richiedere l'accesso ai nostri servizi portal samo web services mail inviare un email a: [portal@samo.it](mailto:portal@samo.it)  
To request access to our SAMO Web Services portal, please send an email to: [portal@samo.it](mailto:portal@samo.it)

## DISPONIBILITÀ DEGLI ARTICOLI / AVAILABILITY OF ITEMS



Questa funzione permette di controllare la disponibilità degli articoli a magazzino.

Per conoscere tale disponibilità, inserire il codice prodotto, che può anche essere seguito dal simbolo \*(asterisco): in questo modo la ricerca verrà ampliata a tutte le varianti di versioni e finiture.

*This function allows you to check the availability of items in stock. To perform the check, simply enter the product code, optionally followed by the \*(asterisk) symbol: this will expand the search to include all available versions and finishes.*

## INSERIMENTO ORDINE ACQUISTO / PURCHASE ORDER ENTRY



### > Differenti modalità di inserimento ordini

L'inserimento ordini può essere eseguito in due modalità principali, a seconda delle necessità dell'utente.

- Diretta: inserimento dal Portale
- EDI: scambio di file digitali tra diversi sistemi gestionali

### > Different ways of entering orders

Orders can be entered in two main ways, depending on the user's needs.

- Direct: entering from the Portal.
- EDI: exchange of digital files between different applications.

## MONITORAGGIO E CONTROLLO DEGLI ORDINI / ORDER MONITORING AND CONTROL



### > Da Portale è possibile:

- Tenere traccia dei propri ordini in produzione e spedizione
- Verificare il flusso documento: connessione tra Ordine, Bolla e Fattura e stampa del pdf relativo
- Visualizzare eventuali ordini bloccati
- Effettuare un'analisi statistica sugli storici dell'ordinato/fatturato con confronti sino a tre anni

### > From the portal, it is possible to:

- Track your orders in production and shipping
- Verify document flow: connection between Order, Delivery Note, and Invoice, with the option to print the related PDF
- View any blocked orders
- Perform a statistical analysis on order/invoice history, with comparisons up to three years



Da portale inoltre è possibile scaricare le istruzioni di montaggio con possibilità di ricerca per serie/codice articolo.  
Additionally, from the portal it is possible to download assembly instructions, with a search option by series/product code

# CONDIZIONI GENERALI / GENERAL CONDITIONS

- 1) I prezzi del listino sono espressi in euro, IVA esclusa, non sono impegnativi e si intendono per merce resa franco stabilimento di Bonavigo (Verona) Italia.
- 2) Qualora la merce per consegne Italia venisse spedita franco destino sarà calcolato un addebito in fattura del 3% sull'imponibile a titolo di concorso spese trasporto.
- 3) L'importo degli ordini minimo con consegna prevista da sede centrale di Bonavigo è di 300,00 Euro imponibile. In caso di deroga per ordini inferiori all'importo minimo sarà addebitato a titolo di contributo fisso forfettario per "gestione ordine minimo", l'importo di 20,00 Euro.
- 4) I depositi regionali permettono di effettuare consegne immediate del materiale disponibile (principalmente in fascia A). Non ci sono limitazioni di importo ordine per le consegne dai depositi regionali italiani. Tutte le consegne effettuate da deposito prevedono una maggiorazione di spesa.
- 5) In caso di insoluti verranno innanzitutto bloccate tutte le spedizioni e tutti gli ordini in corso verranno automaticamente sospesi: al momento del pagamento/sblocco dell'insoluto, gli ordini avranno i tempi di consegna partendo dalla data di sblocco e ricalcolati con le fasce di consegna presenti nel listino.
- 6) Il destinatario è obbligato a controllare la merce in arrivo e a contestare subito gli eventuali danni direttamente al trasportatore che ne è responsabile. È diritto del destinatario e dovere del trasportatore controllare la spedizione (senza aprire l'imballo) e apporre le eventuali riserve specifiche sul DDT del trasportatore e quello SAMO. La sola dicitura generica: "RISERVA DI CONTROLLO" non è valida.
- 7) Danno occulto: nel caso di colli rovinati, solo esternamente, questi possono essere ritirati indicando sui DDT (documento di trasporto) del trasportatore e di SAMO la clausola "RISERVA CONTROLLO", specificando la motivazione per cui si è posta la riserva, come previsto dal regolamento (Legge 22.8.1985 n° 450) vigente. Nel caso di rotture accertate, il destinatario deve darne comunicazione scritta tramite e-mail all'indirizzo samo@samo.it oppure tramite mezzo raccomandata entro e non oltre 8 giorni dal ricevimento merce.
- 8) Danno accertabile: nel caso di danno evidente ed accertabile anche dal trasportatore, deve essere posta una riserva sul DDT del trasportatore e di SAMO indicando chiaramente quantità e codici danneggiati ed il tipo di danno esterno ed interno riscontrato. Copia dei DDT devono essere inviati al servizio clienti SAMO che successivamente darà le opportune disposizioni per l'eventuale sostituzione e reso del materiale.
- 9) Diversamente da quanto previsto ai paragrafi 7 e 8, SAMO non riconoscerà alcun rimborso per danni o rotture riscontrate.
- 10) Nessun articolo può essere reso senza l'autorizzazione scritta da SAMO S.p.A.: i resi autorizzati dovranno pervenire in porto franco al ns. stabilimento utilizzando il trasportatore ed il numero di riferimento comunicati da SAMO. Il numero di riferimento deve essere riportato sul documento di trasporto. Se nell'accurato controllo SAMO si riscontrassero incurie dell'acquirente, il materiale reso sarà gravato di un importo per la copertura delle spese generali oltre ad eventuali spese di ripristino a nuovo.
- 11a) Gli ordini sono soggetti all'approvazione di SAMO S.p.A. Nessun ordine potrà essere annullato o modificato senza il consenso di SAMO S.p.A., che si riserva la facoltà di addebitare eventuali oneri e spese che ne derivano. La conferma dell'avvenuto annullamento o modifica, come anche dell'importo addebitato, sarà effettuata unicamente da SAMO S.p.A. in forma scritta.
- 11b) Il cliente-mittente referente della spedizione del reso deve rendere il materiale autorizzato disponibile ed imballato idoneamente per il trasporto alla data di ritiro indicata nell'autorizzazione concordata. In caso contrario, SAMO SpA si riserva la facoltà di addebitare al cliente-mittente i costi di competenza conseguenti al mancato ritiro.
- 12) I prezzi di questo listino non sono contrattuali: gli ordini vengono accettati a prezzi e condizioni in vigore alla data di spedizione.
- 13) Per fatture inferiori a 300,00 Euro di imponibile, SAMO si riserva la facoltà di modificare le condizioni di pagamento.
- 14) L'imballo normale è gratuito, eventuali imballi rinforzati saranno addebitati al costo.
- 15) **DISPONIBILITÀ A MAGAZZINO:**  
tutti i prodotti SAMO sono selezionati per fasce (A-B-C) in funzione della disponibilità media di magazzino e dei tempi di preparazione e spedizione.  
La fascia A è evidenziata con il carattere del prezzo su sfondo azzurro e indica una disponibilità a magazzino indicativa di 1-2 settimane dal momento della conferma ordine.  
La fascia B è evidenziata con prezzo su sfondo rosa indica una disponibilità a magazzino indicativa di 2-3 settimane dal momento della conferma ordine  
La fascia C è evidenziata con carattere del prezzo su sfondo bianco indica una disponibilità a magazzino indicativa di 3-4 settimane dal momento della conferma ordine.  
Per i prodotti richiesti con trattamento anticalcare Starclean optional e disponibili in fascia di consegna A, la disponibilità a magazzino varierà di una settimana aggiuntiva.  
La disponibilità immediata dei prodotti a magazzino può anche essere richiesta inviando una e-mail all'indirizzo: [gjaccenza-it@samo.it](mailto:gjaccenza-it@samo.it)
- 16) I termini fissati per la spedizione non sono tassativi e in nessun caso possono costituire pretesto per ritardati pagamenti o richieste di risarcimento danni. Gli ordini possono essere anche evasi parzialmente.
- 17) In caso di particolari esigenze logistiche/operative, è possibile richiedere consegne e spedizioni personalizzate (pallettizzate, con linea diretta, etc.) inviando una e-mail al servizio clienti SAMO in modo da concordare tipologia, tempistiche ed eventuale maggiorazione per spese di trasporto e/o per spese di realizzo imballo.
- 18) Le spedizioni vengono eseguite con il mezzo giudicato più idoneo da SAMO S.p.A. e la merce viaggia a rischio e pericolo del committente, anche se spedita per speciali accordi, franco destino.
- 19) I prodotti non a catalogo e/o fabbricati su specifica richiesta del committente non possono essere restituiti.
- 20) I pagamenti dovranno essere effettuati puntualmente al domicilio di Bonavigo e secondo le condizioni stabilite: qualsiasi contestazione non darà diritto all'acquirente di trattenere somme dovute per fatture in essere e/o scadute.
- 21) In mancanza di speciali pattuizioni il pagamento si intende alla consegna.
- 22) I termini di pagamento dovranno essere tassativamente osservati. Sui ritardati pagamenti decorreranno gli interessi legali aggiornati al momento (DLgs 9/10/2002 n° 231), salvo il diritto di SAMO di sospendere o annullare ogni altra consegna senza pregiudizio di ogni altra azione o diritto.
- 1) *The published prices on the present price list are in Euro, exclusive of VAT. The prices are not binding and the goods are delivered ex-works SAMO Spa in Bonavigo (Verona) Italy.*
- 2) *If the products are transported by SAMO or by uncharged forwarder to the client destination, the transport cost will be debited on the invoice with a participation quote.*
- 3) *The minimum order amount with delivery ex-SAMO factory is 300,00 Euro.*
- 4) *In case of non-payment, shipments will be stopped and orders in progress will be suspended. Upon receipt of payment the delivery of the orders will be calculated with a new delivery period as per price list specification, taking the date of payment receipt.*
- 5) *In case exceeding of the agreed credit line, orders will still be accepted by Samo, related shipments will be stopped upon the receipt of a sufficient amount needed to recover into the credit line.*
- 6) *Deliveries must be immediately inspected, in case of wrong items, and/or shortages, and/or any defect, have to be reported to the forwarder which is the only responsible for it. It is in the right of the receiver and the duty of the forwarder to control the delivery (without opening the package). A formal making specific notification on the delivery notes, the generic written phrase "subject to inspection" is not sufficient.*
- 7) *Hidden damage: if on delivery, the goods display obvious packaging defects, they can be with drawn, but the receiver is obliged to note the defects on the PoD marking them with "SUBJECT TO INSPECTION" and specifying reason why, as preview by the European norms in use. In case of proven breakages, the receiver must communicate it in written with a registered letter to SAMO and copy to the forwarder in within 7 days from the reception of the goods.*
- 8) *Verified damage: in case of evident damage verified by the receiver and the forwarder, the damage evidence must be duly marked on PoD, indicating very clearly the quantity and the damaged products codes, verifying if the damage type is occurred on the internal or external side. A further copy of PoD must be sent to SAMO customer service that, successively will arrange the possible replacement upon reception of the damaged goods.*
- 9) *Unlike what is clearly specified on the paragraphs 7 and 8, Samo will not recognised any refund for the verified damage or breakage.*
- 10) *Any Item can be returned without SAMO written permission. Authorised returns must be sent to our warehouse with transport fees paid, using Samo authorised forwarder, indicating the communicated reference number. The reference number must be absolutely reported on PoD. Returns must be perfectly packaged. After Samo control and in case of verified purchaser's neglect, the returned good will be charged of an amount equal to recover general expenses and any possible restoration costs.*
- 11a) *Orders must be approved by Samo. No order can be cancelled without Samo approval, which reserves the right to debit any charges and expenses caused by such cancellation.*
- 11b) *The sender-client responsible for the return shipment must make the authorized material available and properly packaged for transport on the collection date specified in the agreed authorization. Otherwise, SAMO SpA reserves the right to charge the sender-client for any costs incurred due to the failed collection.*
- 12) *Orders are intended as per commercial conditions in use at the moment of the order acceptance or release.*
- 13) *SAMO reserves the right to change the payment terms for orders below 300,00 Euro.*
- 14) *Normal packaging is free; any reinforced packaging will be charged at the cost.*
- 15) **INDICATIVE PRODUCTION TERMS:**  
all SAMO products are selected by different production terms (A-B-C) in accordance to the manufacturing times table.  
*Band A is highlighted with price character on light-blue background and has an indicative production time of 1-2 weeks starting from order confirmation.*  
*Band B is highlighted with price character on pink background and has an indicative production time of 2-3 weeks starting from order confirmation.*  
*Band C is highlighted with the price character on gray background and has an indicative production time of 3-4 weeks.*  
*The immediate warehouse product availability can be requested also sending an e-mail to the internet address: [export@samo.it](mailto:export@samo.it)*
- 16) *The mentioned delivery terms are not binding Samo and absolutely in no case they constitute an excuse for payment delays or damages or complains compensation. The orders may be also partially fulfilled.*
- 17) *It is possible to require personalized deliveries and/or transports (pallets, iron baskets, with direct line, etc...) by sending an e-mail to Samo address [export@samo.it](mailto:export@samo.it) agreeing typology, terms and any possible increases for transport and/or packing costs.*
- 18) *The goods travel always at the consignee's risk even if they are sent for special agreements as "free delivery".*
- 19) *Any return of any special, or out of catalogue product will be accepted.*
- 20) *Payments shall be made by bank transfer and accordingly to specific commercial conditions in use. Any dispute will not give the buyer the right to deduct any amounts from the due expired or expiring invoices.*
- 21) *Unless otherwise agreed, the payments shall be made in advance.*
- 22) *The agreed payment terms shall be strictly observed. In case of payment delay, will be charged interests as per Italian and European norms valid, giving to SAMO the full right to suspend any kind of delivery without any prejudicial and any other kind of action or right.*
- 23) *The supplied products remain of SAMO S.p.a. property until the full payment is received in accordance to the Italian and European norms.*
- 24) *Warranty. Samo Spa guarantees its products for 24 months from the date of delivery according to the European directives. The warranty exclusively covers manufacturing irregularities or material defects. Aesthetic or functional defects must be communicated in writing to Samo Spa only and exclusively before installation, enclosing purchase and product documents.*
- 25) *Samo Spa warranty will be exclusively valid for the repair or the replacement of defective elements: no other purchaser claims shall be considered, absolutely excluding any derived discomfort, burden or accessory cost. The claimed non-compliance must be recognised by Samo Spa authorized technical personnel.*

- 23) I prodotti forniti rimangono di proprietà di SAMO S.p.A. fino ad integrale pagamento del prezzo, come previsto dal C.C.art. 1523 e segg.
- 24) Garanzia. SAMO SpA garantisce i propri prodotti per 24 mesi a decorrere dalla data d'acquisto e comunque entro i limiti del DPR n°224 del 24/05/1988 e secondo le direttive Europee. La garanzia copre esclusivamente vizi e difetti di fabbricazione o assemblaggio. Difetti estetici o strutturali devono essere comunicati per iscritto a SAMO SpA solo ed esclusivamente prima dell'installazione, allegando i documenti di acquisto e di prodotto.
- 25) La garanzia impegna SAMO SpA solo alla riparazione e/o alla sostituzione degli elementi difettosi: sono pertanto escluse ulteriori pretese da parte dell'acquirente, ed esclude qualsiasi indennizzo derivato dal disagio, od onere o costo relativo accessorio. La non conformità dovrà essere riconosciuta solo da parte di personale autorizzato da SAMO SpA.
- 26) Sono comunque esclusi dalla garanzia i seguenti casi:
- Se il difetto è riconducibile al trasporto.
  - Rotture di tutte le parti in vetro temperato, in particolare causate da impatto, urti durante il trasporto, movimentazione manuale degli elementi in fase di installazione e impatti accidentali durante l'utilizzo.
  - Se l'installazione non è stata eseguita dettagliatamente secondo istruzioni SAMO.
  - Se il vizio di funzionamento è conseguente ad un intervento sul prodotto non autorizzato.
  - Se il funzionamento difettoso è conseguente alla normale usura del prodotto, alla negligenza o incuranza da parte dell'acquirente nel rispetto delle indicazioni allegate al prodotto.
  - Se il difetto è riconducibile all'utilizzo di detersivi abrasivi, a base acida, o prodotti non adatti alla pulizia di superfici laccate, verniciate, anodizzate e vetrose.
  - Se il funzionamento difettoso è conseguente a forze maggiori.
  - Manomissione e modifica del prodotto da parte dell'acquirente.
  - Sostituzione di tutti i componenti soggetti a normale e naturale usura o variazione di colore causata da agenti esterni.
- 27) SAMO SpA declina qualsiasi responsabilità per eventuali danni a persone, animali o cose causati da errori di installazione, di regolazione, imperfetto utilizzo o la mancata osservanza di tutte le prescrizioni indicate nella documentazione allegata al prodotto.
- 28) SAMO si riserva il diritto di apportare modifiche tecniche ed estetiche ai propri prodotti in qualsiasi momento senza preavviso, ivi comprese modifiche a volume e peso.
- 29) Ogni eventuale pattuizione che possa derogare, in tutto o in parte, alle presenti condizioni generali, deve risultare da espresso accordo scritto.
- 30) Il presente listino prezzi annulla tutti i precedenti ed è valido solo per le aree geografiche di competenza.
- 31) Per ogni controversia è competente unicamente il Foro di VERONA - ITALIA.
- 32) Ai sensi del GDPR (Reg. UE n°679 del 27.04.2016 e del DLgs n°16/2003) SAMO S.p.A. dichiara che i dati messi a disposizione dal committente verranno elaborati in rispetto della legge sulla tutela della privacy.
- 33) Tutte le suddette condizioni di vendita si intendono integralmente accettate con il conferimento dell'ordine.
- 26) *Samo Spa warranty lapses automatically in following cases:*
- *If defect has reference to transport;*
  - *Tempered glass parts breakages;*
  - *If installation isn't performed following in detail Samo instruction;*
  - *If functioning defect is due to unauthorized technical intervention on product;*
  - *If defective functioning is due to the normal product usury, or to the purchaser negligence or carelessness following product indication;*
  - *If defect is due to the use of acid based or abrasive detergents, or cleaning products not suitable for glass, anodized, lacquered or varnished surfaces. Use of Samo cleaning products is suggested;*
  - *If defective functioning is due to a "force majeure" reason;*
  - *Purchaser manumission of the product.*
- 27) *Samo Spa declines any responsibility for possible people, animals or goods damage due to installation or adjustments errors, imperfect use or no observance of all prescriptions indicated in product enclosed documents*
- 28) *SAMO reserves the full right to technically and aesthetically modify the product at anytime and without previous notice, including changes in volume and weight.*
- 29) *Any possible agreement variation that totally or partially change the present general condition, shall be resulted exclusively by written agreement.*
- 30) *This price list invalidate and cancel all previous.*
- 31) *For any dispute, the only competent jurisdiction is the Court of Verona-Italy.*
- 32) *In reference to the valid European norms, Samo SpA declares that the information made available by the client will be processed according to the law on the protection of privacy.*
- 33) *All the above-mentioned terms and conditions of sale are intended as having been fully accepted with the confirmation of the order.*

**SAMO S.P.A.**  
 Via Cav. Orville Venturato, 1 - 37040 BONAVIGO (VR) - ITALY  
 Tel. +39 (0) 442 73018 Fax +39 (0) 442 670033  
 www.samo.it - samo@samo.it





**SIAMO SOSTENIBILI. SIAMO RESPONSABILI.**

Questo catalogo è **Be Emission Free**  
Le emissioni di CO<sub>2</sub> dell'intero processo produttivo sono state  
compensate, così da portare avanti il percorso sostenibile  
intrapreso in questi anni da SAMO S.p.A

**WE ARE SUSTAINABLE. WE ARE RESPONSIBLE.**

*This catalog is **Be Emission Free**  
The CO<sub>2</sub> emissions from the entire production process have been  
offset, continuing the sustainable path undertaken in recent years  
by SAMO S.p.A*



Anticalcare StarClean di serie  
Standard StarClean anti-limescale



Anticalcare StarClean optional  
Optional StarClean anti-limescale



Lato reversibile  
Reversible side



Lato non reversibile  
Non-reversible side



Estensibilità e regolazione fuorisquadra  
Extendability and out-of-square adjustment



No estensibilità e regolazione fuorisquadra  
No extendability and out-of-square adjustment



Sgancio anta scorrevole  
Sliding door release



No sgancio anta scorrevole  
No sliding door release



Abbinabile a parete fissa  
Compatible with fixed panel



Non abbinabile a parete fissa  
Not compatible with fixed panel



Anta sollevabile  
Lift-up door



Kit di sostegno inclinabile di serie  
Standard tilting support kit



Kit di sostegno inclinabile optional  
Optional tilting support kit



Kit di sostegno fisso di serie  
Standard fixed support kit



Kit di sostegno fisso optional  
Optional fixed support kit



Cerniera 0-180° con sollevamento anta  
0-180° hinge with door lifting mechanism



Frangiflutto o binario inferiore  
Bottom track or guide rail



Profilo di compensazione disponibile  
Compensation profile available



Open

Apertura e chiusura anta ammortizzate di serie  
Standard cushioned door opening and closing



Close

Chiusura anta ammortizzata di serie  
Standard cushioned door closing



Close

Chiusura anta ammortizzata optional  
Optional cushioned door closing



Componenti con incollaggio UV  
Components with UV bonding



Tecnologia triplo magnete  
Triple magnet technology



Installazione in nicchia  
Niche installation



Installazione in angolo  
Corner installation



Installazione su parete / Tre lati  
Wall / Three-sided installation



SAMO S.P.A. Via Cav. Orvile Venturato, 1 - 37040 BONAVIGO (VR) - ITALY  
Tel. +39 (0) 442 73018 Fax +39 (0) 442 670033

[www.samo.it](http://www.samo.it)