

Novelties 2023

made with love

prismacer
cerámica

PORCEBLOC

Brighton
Halley Lab.
Jeans Lab.
Vein Lab.

Porcelánico / Porcelain Tile

ESTÉTICA IMPECABLE
IMPECCABLE AESTHETICS
ÉLÉGANCE IMPECCABLE

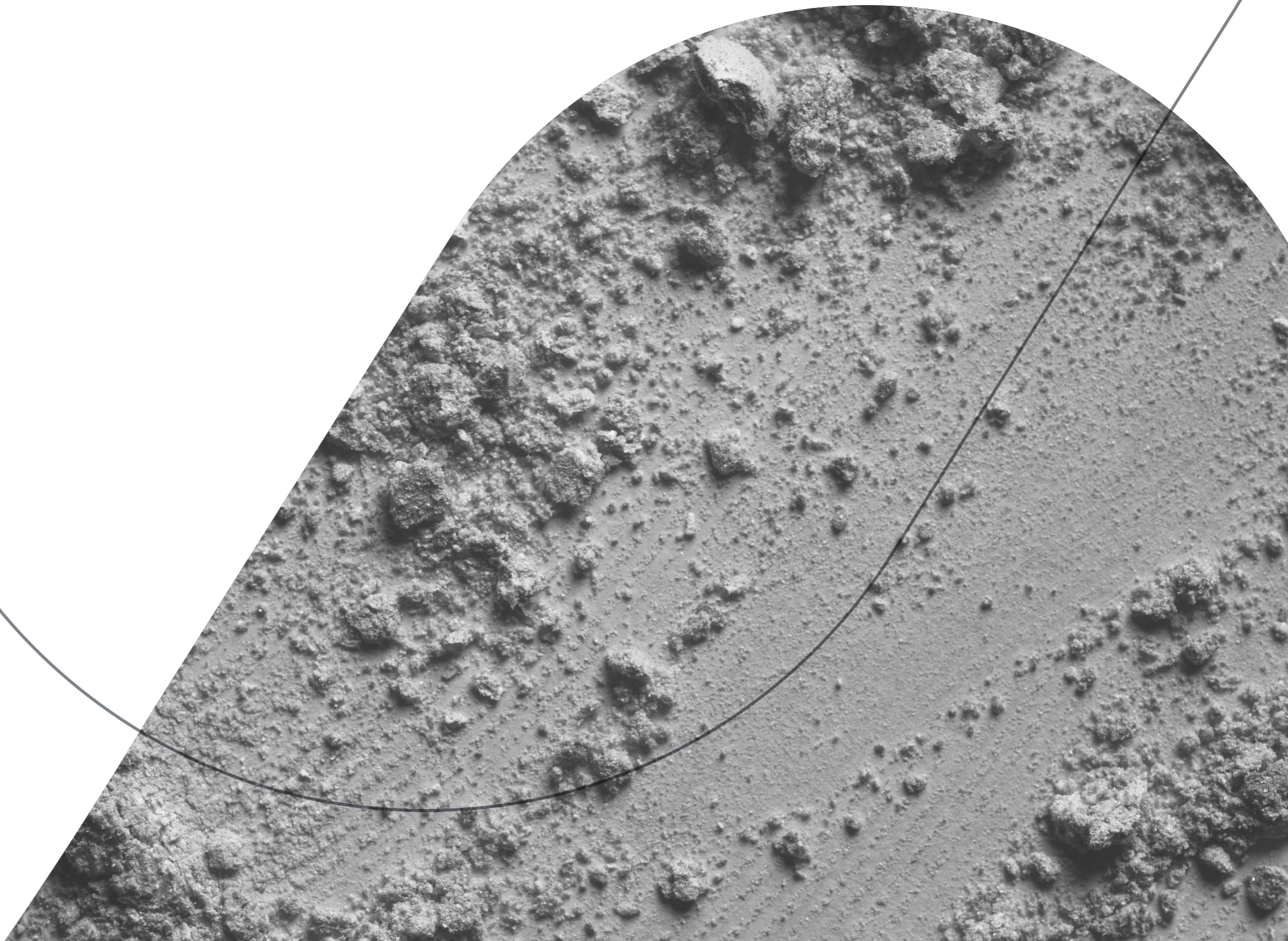



Brighton — Porceblot



Brighton Grey 120x120

Brighton

Brighton Pearl

Brighton Grey

Brighton Mud

Brighton Light

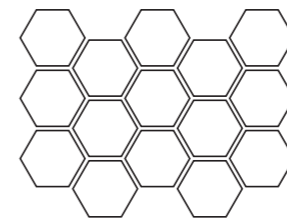

Malla Hex Brighton
32,5x22,5

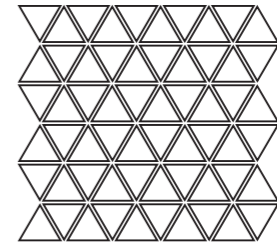

Malla Tris Brighton
30x30 (5,7x5,7x5,7)

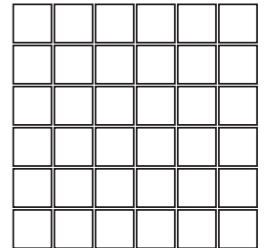

Malla Brighton
30x30 (5x5)

Piezas complementarias Complementary Tiles / Pièces Complémentaires

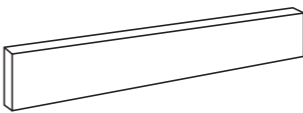
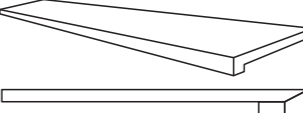
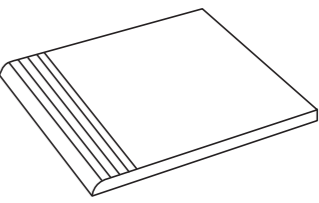
RODAPIÉ	PELDAÑO	PELDAÑO ROMADO / RANURADO
		



Brighton Light 60x120 - 120x120 - Malla

32,5x22,5



30x30
(5,7x5,7x5,7)

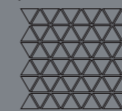

30x30 (5x5)



Formatos / Formats

120x120

90x90

60x60

60x120

30x60

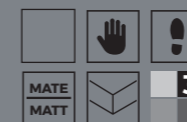

Formato	Pz/cj	Pz/pl	M²/cj	M²/pl	Cj/pl	Kg/cj	Kg/Total
30x60 (C)	6	288	1,08	51,84	48	22,00	1076
60x60	4	120	1,44	43,2	30	30,00	920
60x120	2	64	1,44	46,08	32	34,50	1129
90x90	2	54	1,62	43,74	27	40,00	1110
120x120	1	36	1,44	51,84	36	38,40	1422,4
MALLA HEX	9	432	0,65	31,2	48	13,50	668
MALLA TRIS	7	336	0,63	30,24	48	15,40	759,2
MALLA (5)	11	462	1,00	42	42	23,00	986

Porcebloc 30x60 / 60x60 / 60x120 / 90x90 / 120x120
 11.81"x23.62" / 23.62"x23.62" / 23.62"x47.24" /
 35.43"x 35.43" / 47.24"x47.24"



Lab. Halley ——— Porceblot



Lab. Halley Argent 120x120

Lab. Halley



Lab. Halley Argent



Lab. Halley Mud

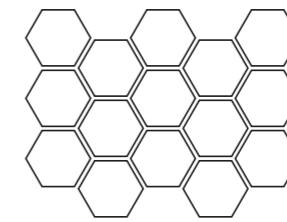

Malla Hex Lab. Halley
32,5x22,5

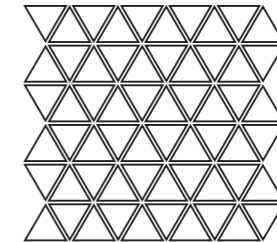

Malla Tris Lab. Halley
30x30 (5,7x5,7x5,7)

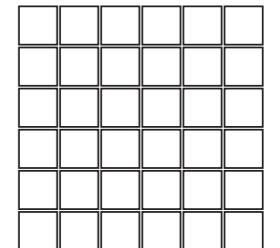

Malla Lab. Halley
30x30 (5x5)

Piezas complementarias
Complementary Tiles / Pièces Complémentaires

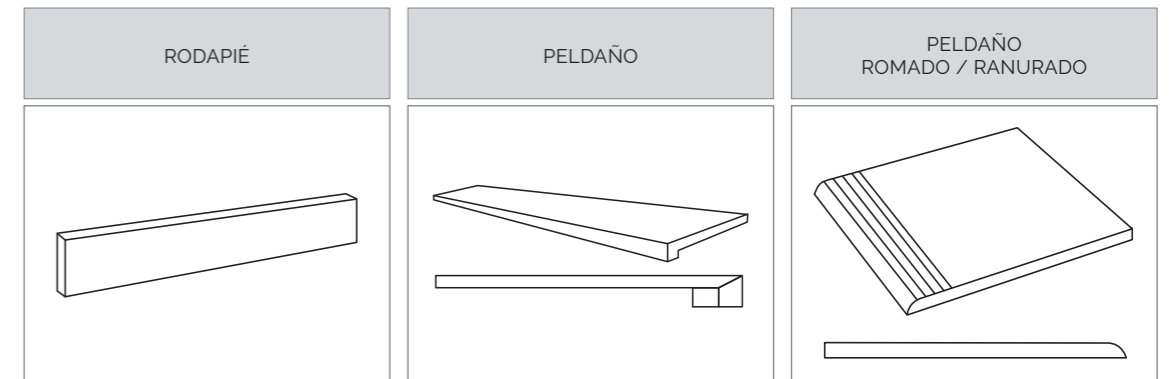

Formatos / Formats

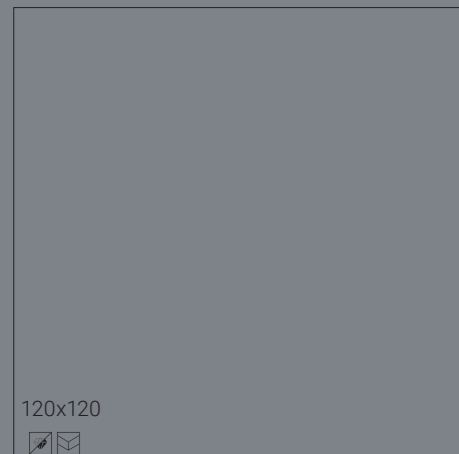

120x120

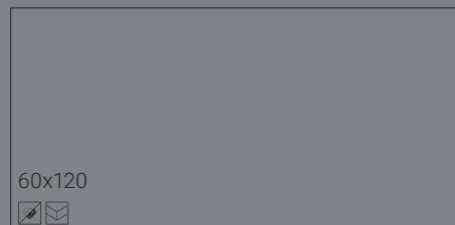

60x120

32,5x22,5



30x30
(5,7x5,7x5,7)

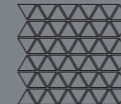

30x30 (5x5)



	Formato	Pz/cj	Pz/pl	M ² /cj	M ² /pl	Cj/pl	Kg/cj	Kg/Total
	60x120	2	64	1,44	46,08	32	34,50	1129
	120x120	1	36	1,44	51,84	36	38,40	1422,4
	MALLA HEX	9	432	0,65	31,2	48	13,50	668
	MALLA TRIS	7	336	0,63	30,24	48	15,40	759,2
	MALLA (5)	11	462	1,00	42	42	23,00	986
	Porcebloc	60x120 / 120x120 23.62"x47.24" / 47.24"x47.24"						



Lab. Naica — Porcebtloc



Lab. Naica 120x120

Lab. Naica



Lab. Naica

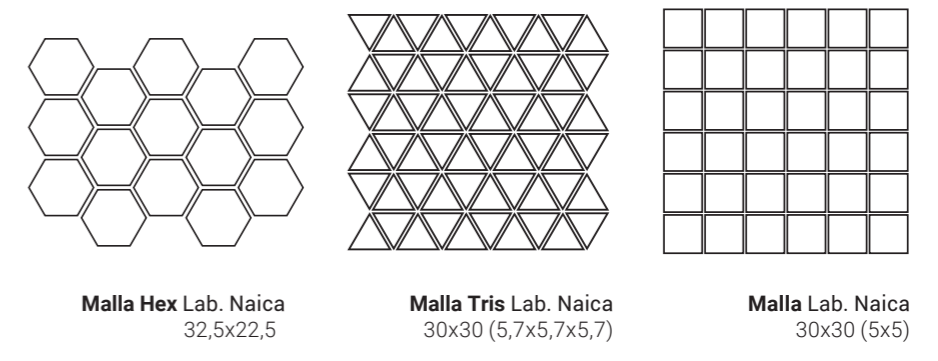

Malla Hex Lab. Naica
32,5x22,5

Malla Tris Lab. Naica
30x30 (5,7x5,7x5,7)

Malla Lab. Naica
30x30 (5x5)

Piezas complementarias
Complementary Tiles / Pièces Complémentaires

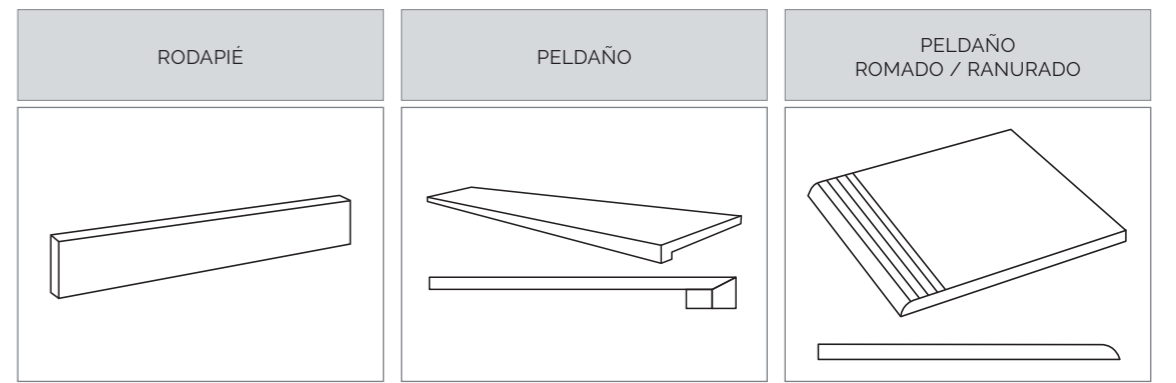

Formatos / Formats

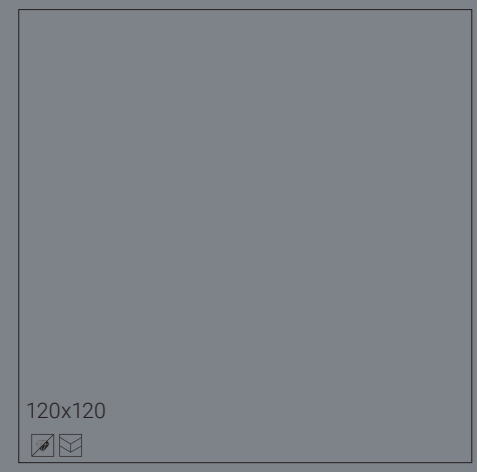

32,5x22,5



30x30
(5,7x5,7x5,7)

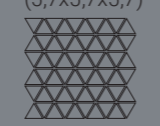

30x30 (5x5)

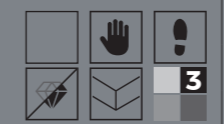
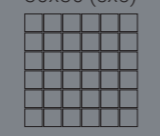

	Formato	Pz/cj	Pz/pl	M ² /cj	M ² /pl	Cj/pl	Kg/cj	Kg/Total
	60x120	2	64	1,44	46,08	32	34,50	1129
	120x120	1	36	1,44	51,84	36	38,40	1422,4
	MALLA HEX	9	432	0,65	31,2	48	13,50	668
	MALLA TRIS	7	336	0,63	30,24	48	15,40	759,2
	MALLA (5)	11	462	1,00	42	42	23,00	986
	Porcebloc	60x120 / 120x120 23.62"x47.24" / 47.24"x47.24"						



Lab. Jeans _____ Porceblot



Lab. Jeans Blue 120x120

Lab. Jeans

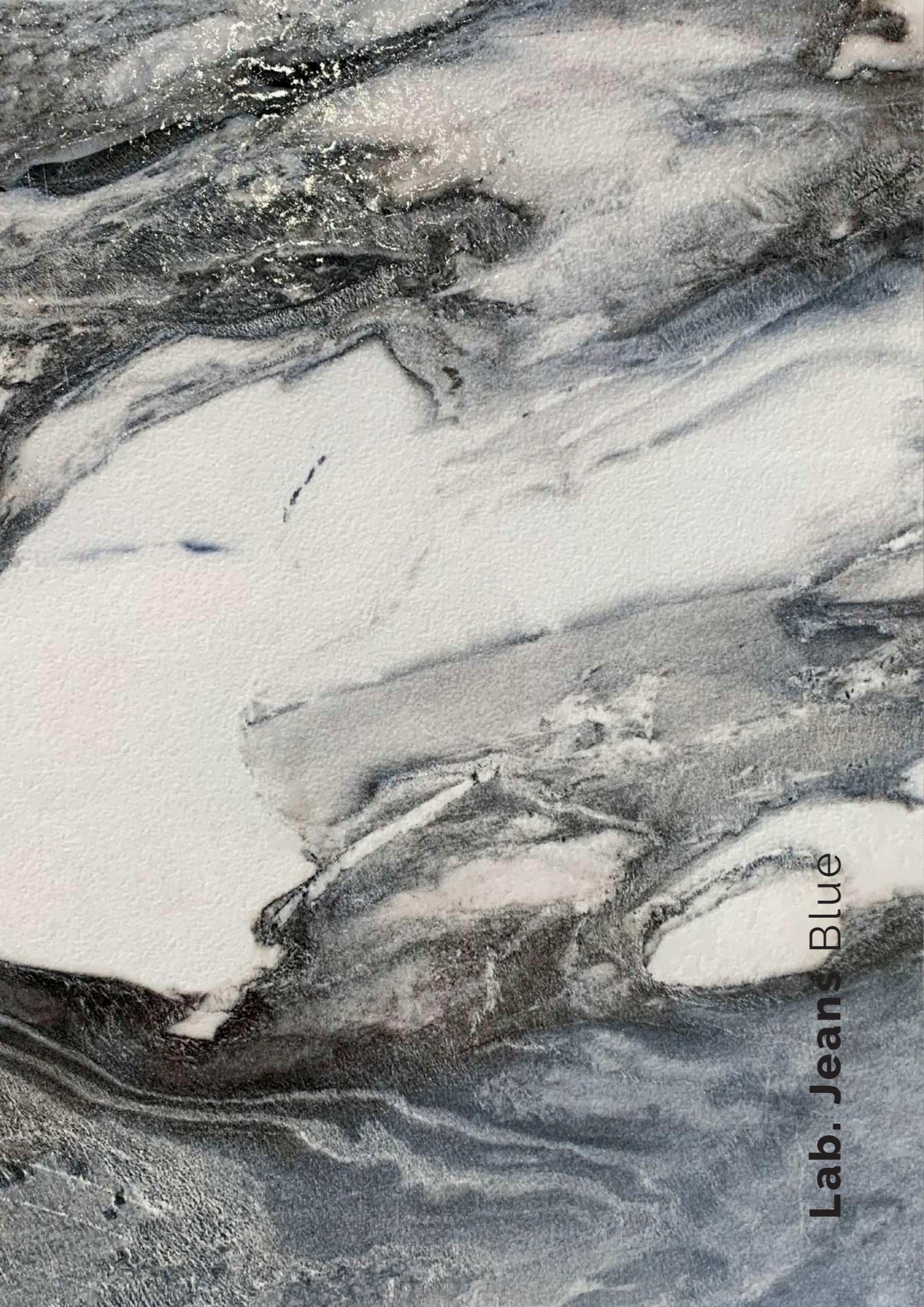

Lab. Jeans Blue



Lab. Jeans Cream



Lab. Jeans Grigio

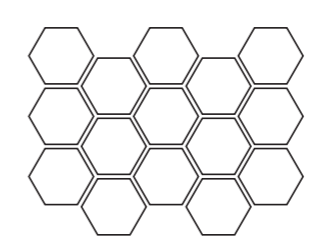

Malla Hex Lab. Jeans
32,5x22,5

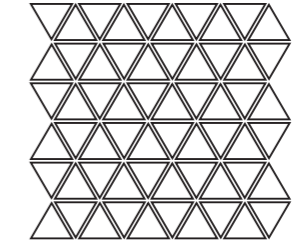

Malla Tris Lab. Jeans
30x30 (5,7x5,7x5,7)

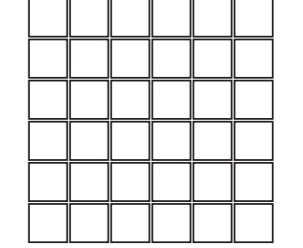

Malla Lab. Jeans
30x30 (5x5)

Piezas complementarias
Complementary Tiles / Pièces Complémentaires

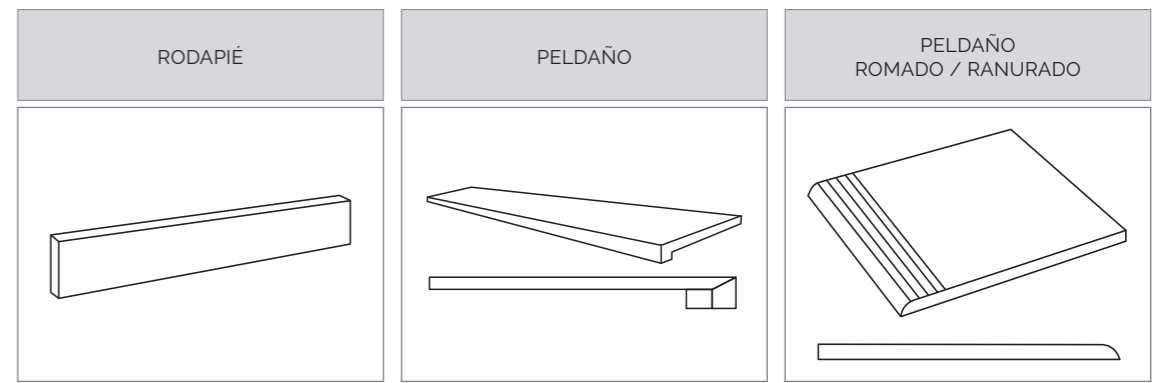

Formatos / Formats

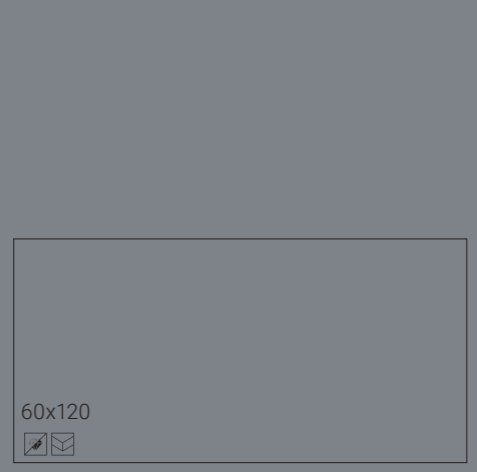

32,5x22,5





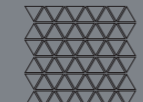









30x30
(5,7x5,7x5,7)



30x30 (5x5)



Formato	Pz/cj	Pz/pl	M²/cj	M²/pl	Cj/pl	Kg/cj	Kg/Total
60x120   	2	64	1,44	46,08	32	34,50	1129
120x120   	1	36	1,44	51,84	36	38,40	1422,4
MALLA HEX   	9	432	0,65	31,2	48	13,50	668
MALLA TRIS   	7	336	0,63	30,24	48	15,40	759,2
MALLA (5)   	11	462	1,00	42	42	23,00	986

Porcebloc 60x120 / 120x120
23.62"x47.24" / 47.24"x47.24"



Lab. Vein — Porceblot



Lab. Vein

Lab. Vein Taupe 60x120 - 120x120



Lab. Vein Perla



Lab. Vein Gris



Lab. Vein Marfil



Lab. Vein Taupe

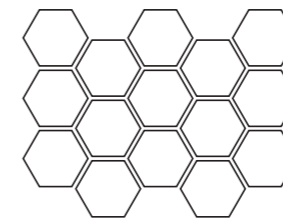

Malla Hex
32,5x22,5

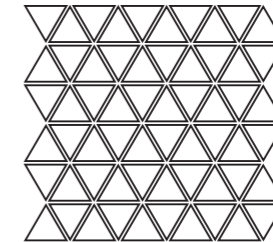

Malla Tris
30x30 (5,7x5,7x5,7)

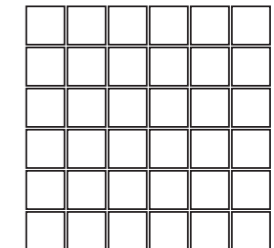

Malla
30x30 (5x5)

Piezas complementarias
Complementary Tiles / Pièces Complémentaires

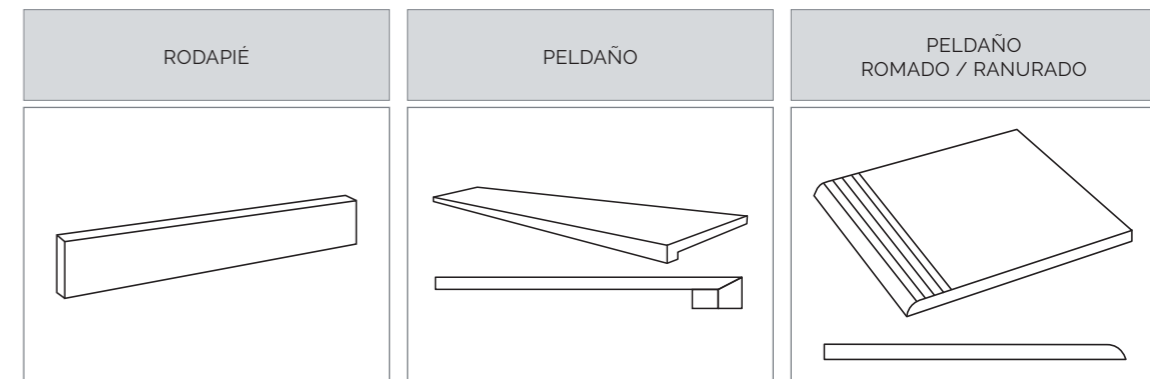

Formatos / Formats

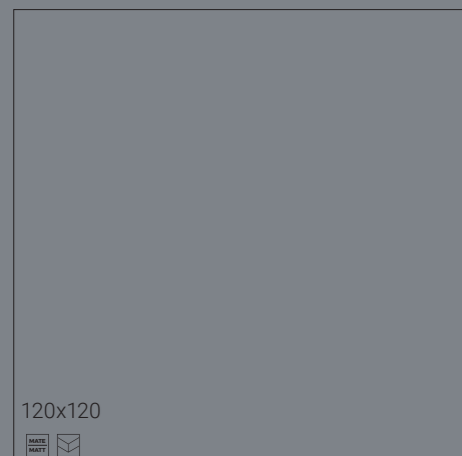

120x120

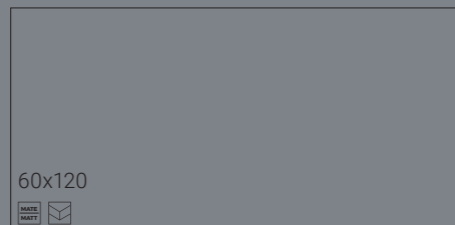

60x120

32,5x22,5



30x30
(5,7x5,7x5,7)

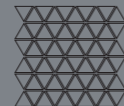

30x30 (5x5)

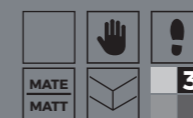

	Formato	Pz/cj	Pz/pl	M ² /cj	M ² /pl	Cj/pl	Kg/cj	Kg/Total
	60x120	2	64	1,44	46,08	32	34,50	1129
	120x120	1	36	1,44	51,84	36	38,40	1422,4
	MALLA HEX	9	432	0,65	31,2	48	13,50	668
	MALLA TRIS	7	336	0,63	30,24	48	15,40	759,2
	MALLA (5)	11	462	1,00	42	42	23,00	986

Porcebloc 60x120 / 120x120
23.62"x47.24" / 47.24"x47.24"

PORCELUX

Bari
Fior di Bosco
Stellar
Sun

Porcelánico Pulido y Mate / Polished and Matt Porcelain

EXCELENCIA EN PULIDO Y MATE SATINADO
EXCELLENCE IN POLISH AND SOFT MATT

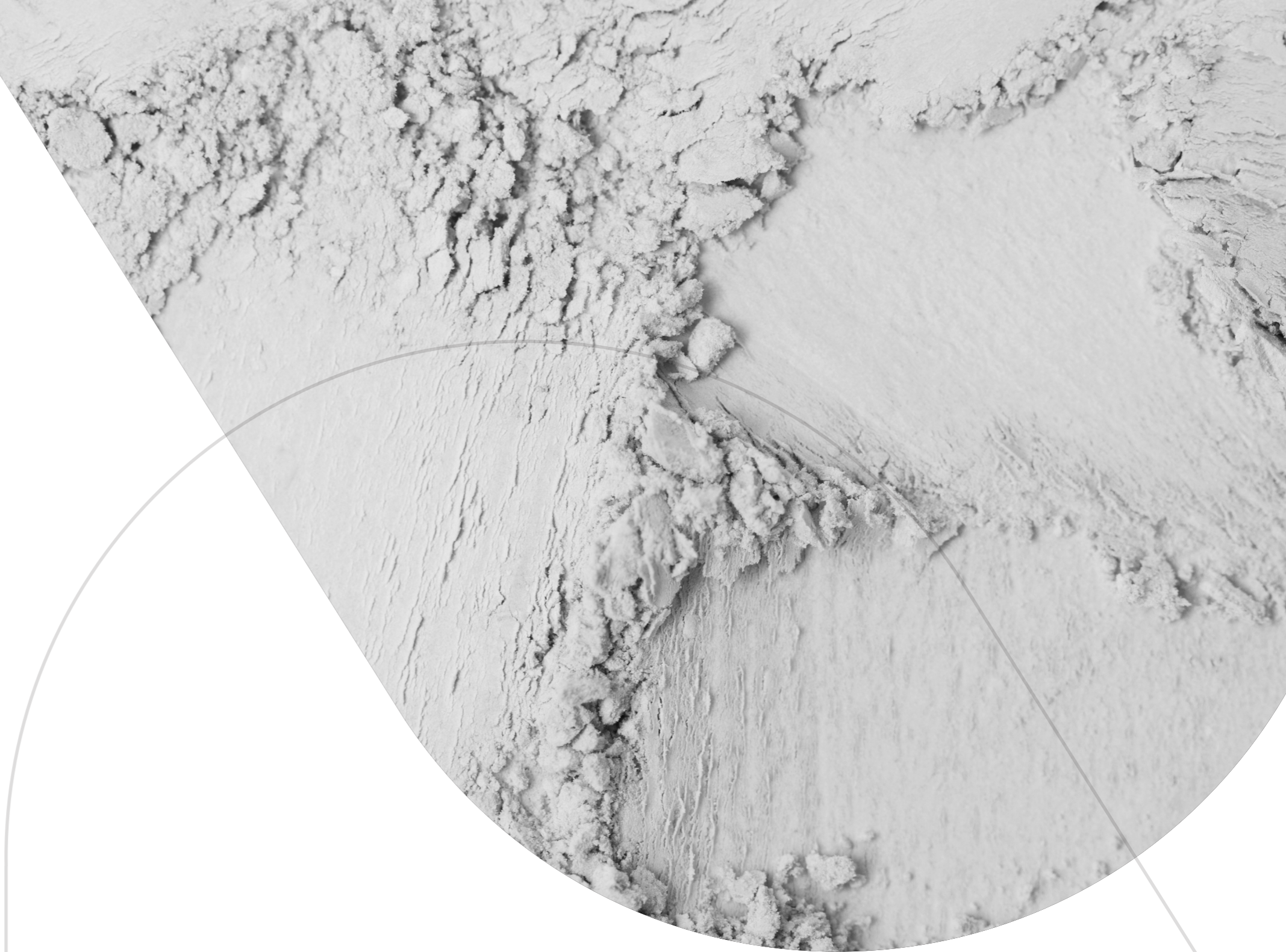



Bari — Porcelux



Bari Marfil 60x120

Bari



Bari Marfil

Formatos / Formats

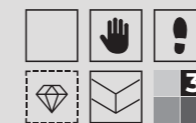
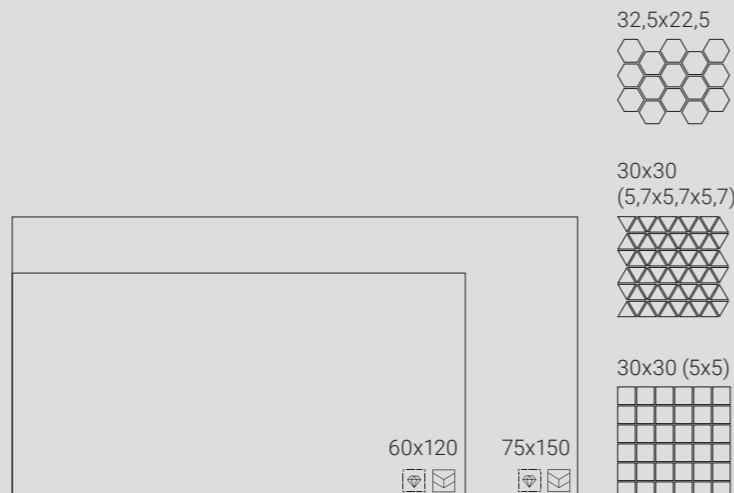
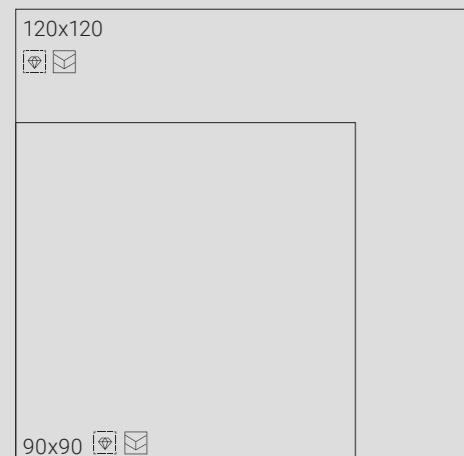

Formato	Pz/cj	Pz/pl	M ² /cj	M ² /pl	Cj/pl	Kg/cj	Kg/Total
60x120	2	64	1,44	46,08	32	34,50	1129
75x150	1	40	1,13	45,2	40	28,00	1184
90x90	2	54	1,62	43,74	27	40,00	1110
120x120	1	36	1,44	51,84	36	38,40	1422,4
MALLA HEX	9	432	0,65	31,2	48	13,50	668
MALLA TRIS	7	336	0,63	30,24	48	15,40	759,2
MALLA (5)	11	462	1,00	42	42	23,00	986

Porcelux 60x120 / 75x150 / 90x90 / 120x120
23.62"x47.24" / 29.53"x59.05" / 35.43"x35.43" / 47.24"x47.24"

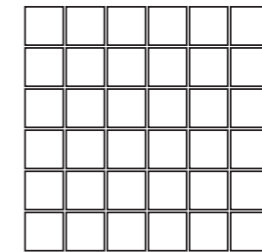

Malla Bari Marfil
30x30 (5x5)

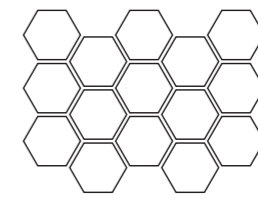

Malla Hex Bari Marfil
32,5x22,5

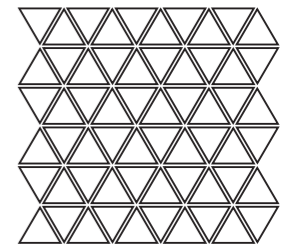

Malla Tris Bari Marfil
30x30 (5,7x5,7x5,7)

Piezas complementarias Complementary Tiles / Pièces Complémentaires





Fior di Bosco — Porcelux



Fior di Bosco

Fior di Bosco Sand 60x120 - 120x120



Fior di Bosco Noce



Fior di Bosco Perla

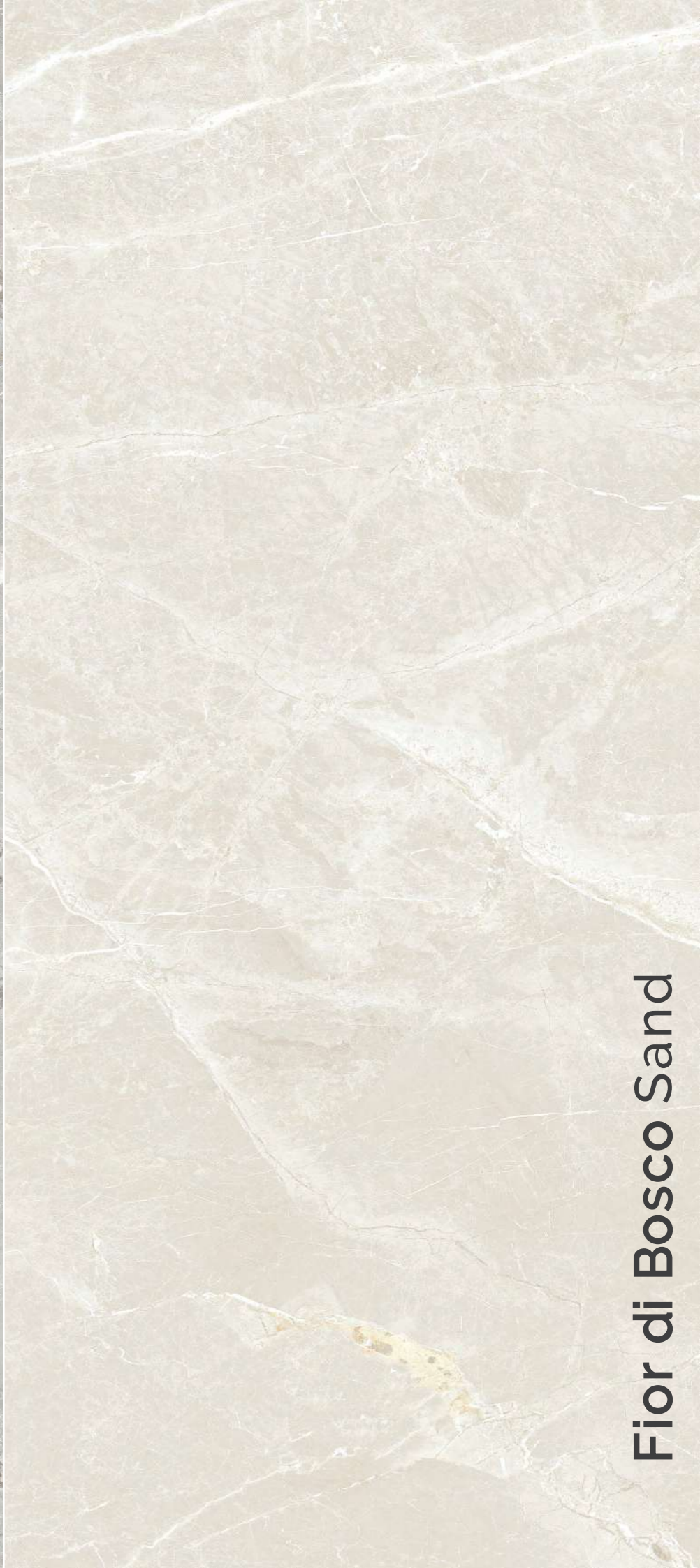

Fior di Bosco Sand

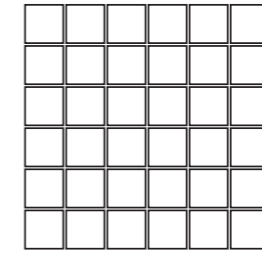

Malla Fior di Bosco
30x30 (5x5)

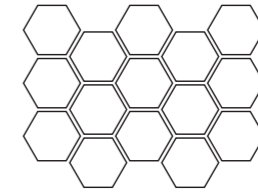

Malla Hex Fior di Bosco
32,5x22,5

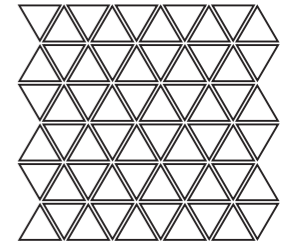

Malla Tris Fior di Bosco
30x30 (5,7x5,7x5,7)

Piezas complementarias
Complementary Tiles / Pièces Complémentaires



Formatos / Formats

120x120	32,5x22,5
90x90	30x30 (5,7x5,7x5,7)
60x60	30x30 (5x5)
30x60	
60x120	
75x150	



Formato	Pz/cj	Pz/pl	M²/cj	M²/pl	Cj/pl	Kg/cj	Kg/Total
30x60 (C)	6	288	1,08	51,84	48	22,00	1076
60x60	4	120	1,44	43,2	30	30,00	920
60x120	2	64	1,44	46,08	32	34,50	1129
75x150	1	40	1,13	45,2	40	28,00	1184
90x90	2	54	1,62	43,74	27	40,00	1110
120x120	1	36	1,44	51,84	36	38,40	1422,4
MALLA HEX	9	432	0,65	31,2	48	13,50	668
MALLA TRIS	7	336	0,63	30,24	48	15,40	759,2
MALLA (5)	11	462	1,00	42	42	23,00	986

Porcelux
30x60 / 60x60 / 60x120 / 75x150 / 90x90 / 120x120
11.81"x23.62" / 23.62"x23.62" / 23.62"x47.24" /
29.53"x59.06" / 35.43"x35.43" / 47.24"x47.24"

Fior di Bosco



Stellar

Porcelux



Stellar White 120x120

Stellar

Stellar White

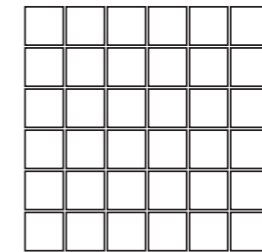

Malla Stellar White
30x30 (5x5)

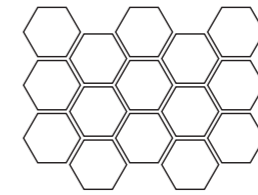

Malla Hex Stellar White
32,5x22,5

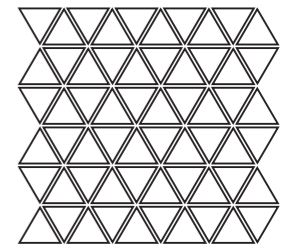

Malla Tris Stellar White
30x30 (5,7x5,7x5,7)

Piezas complementarias
Complementary Tiles / Pièces Complémentaires



Formatos / Formats

120x120	30x30	32,5x22,5
90x90	60x120	30x30 (5,7x5,7x5,7)
60x60	30x60	30x30 (5x5)
	75x150	



Formato	Pz/cj	Pz/pl	M²/cj	M²/pl	Cj/pl	Kg/cj	Kg/Total
30x60 (C)	6	288	1,08	51,84	48	22,00	1076
60x60	4	120	1,44	43,2	30	30,00	920
60x120	2	64	1,44	46,08	32	34,50	1129
75x150	1	40	1,13	45,2	40	28,00	1184
90x90	2	54	1,62	43,74	27	40,00	1110
120x120	1	36	1,44	51,84	36	38,40	1422,4
MALLA HEX	9	432	0,65	31,2	48	13,50	668
MALLA TRIS	7	336	0,63	30,24	48	15,40	759,2
MALLA (5)	11	462	1,00	42	42	23,00	986

Porcelux
30x60 / 60x60 / 60x120 / 75x150 / 90x90 / 120x120
11.81"x23.62" / 23.62"x23.62" / 23.62"x47.24" /
29.53"x59.05" / 35.43"x35.43" / 47.24"x47.24"



Sun — Porcelux



Sun Sand 60x120 - 120x120

Sun

A close-up view of a textured surface with a warm, sandy beige color. The texture is irregular and fibrous, resembling crumpled paper or a natural material like sandstone.

Sun Sand

A close-up view of a textured surface with a light, pearlescent blue-grey color. The texture is similar to the Sun Sand sample, with a crumpled, fibrous appearance.

Sun Pearl

A close-up view of a textured surface with a bright, clean white color. The texture is consistent with the other samples, showing a crumpled, fibrous structure.

Sun White



Sun Pearl 60x120 - 120x120

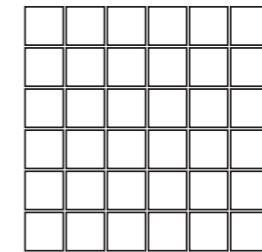

Malla Sun
30x30 (5x5)

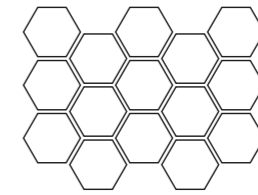

Malla Hex Sun
32,5x22,5

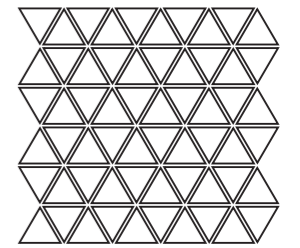

Malla Tris Sun
30x30 (5,7x5,7x5,7)

Piezas complementarias
Complementary Tiles / Pièces Complémentaires

RODAPIÉ	PELDAÑO	PELDAÑO ROMADO / RANURADO

Formatos / Formats

120x120	32,5x22,5
90x90	30x30 (5,7x5,7x5,7)
60x60	30x30 (5x5)
30x60	
60x120	
75x150	



Formato	Pz/cj	Pz/pl	M²/cj	M²/pl	Cj/pl	Kg/cj	Kg/Total
30x60 (C)	6	288	1,08	51,84	48	22,00	1076
60x60	4	120	1,44	43,2	30	30,00	920
60x120	2	64	1,44	46,08	32	34,50	1129
75x150	1	40	1,13	45,2	40	28,00	1184
90x90	2	54	1,62	43,74	27	40,00	1110
120x120	1	36	1,44	51,84	36	38,40	1422,4
MALLA HEX	9	432	0,65	31,2	48	13,50	668
MALLA TRIS	7	336	0,63	30,24	48	15,40	759,2
MALLA (5)	11	462	1,00	42	42	23,00	986

Porcelux 30x60 / 60x60 / 60x120 / 75x150 / 90x90 / 120x120
11.81"x23.62" / 23.62"x23.62" / 23.62"x47.24" /
29.53"x59.06" / 35.43"x35.43" / 47.24"x47.24"

SSMALL COLLECTION

Bercy

DONDE NACE LA MAGIA
WHERE MAGIC IS BORN
LÀ OÙ NAÎT LA MAGIE

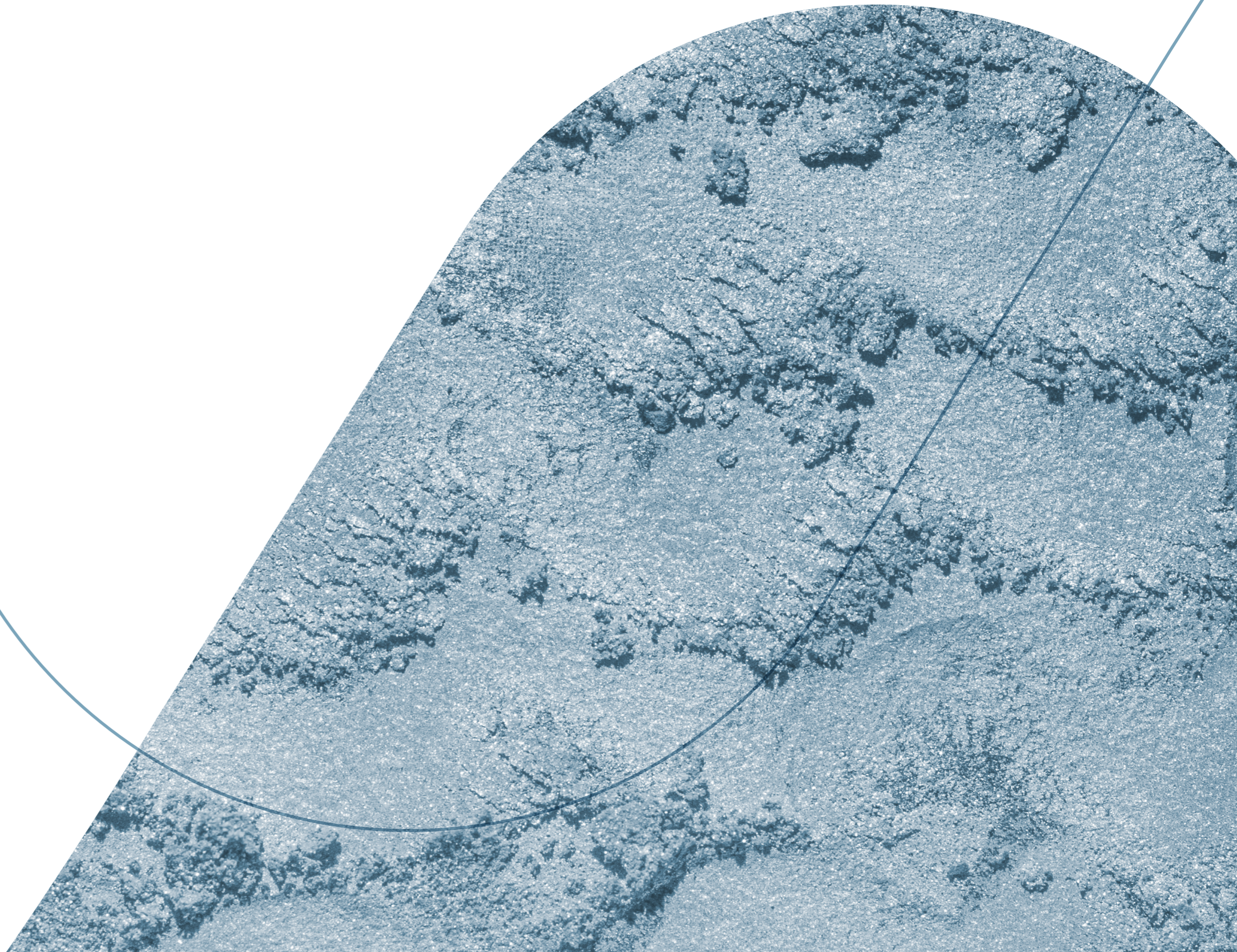

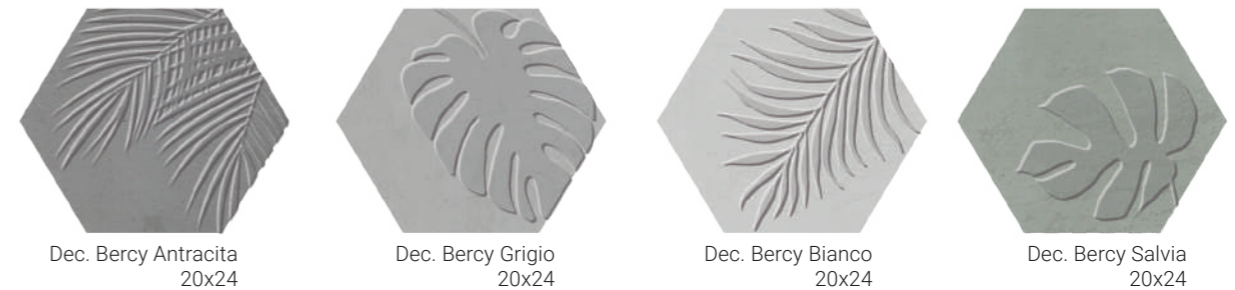

Formato	Pz/cj	Pz/pl	M²/cj	M²/pl	Cj/pl	Kg/cj	Kg/Total
■ 22,3x22,3	20	900	1,00	45	45	24,00	1100
■ 22,3x22,3 Dec.	20	900	1,00	45	45	24,00	1100
■ 20x24	25	1500	0,92	55,2	60	17,33	1060
■ 20x24 Dec.	25	1500	0,92	55,2	60	17,33	1060



Porcelain 22,3x22,3 / 19,8x22,8
8.78"x8.78" / 7.8"x8.97"



Formato	Pz/cj	Pz/pl	M²/cj	M²/pl	Cj/pl	Kg/cj	Kg/Total
■ 7,5x30	25	3025	0,56	67,76	121	12,20	1496,20
■ 7,5x30 Dec.	25	3025	0,56	67,76	121	12,20	1496,20

Pasta Blanca / White Body Tiles 7,5x30
2.95"x11.81"



Porcelánico / Polished

ESENCIAL Y ÚNICO
ESSENTIAL & UNIQUE
ESSENTIEL ET UNIQUE

- Rlv. Gaudí Ess.
- Rlv. Brick Ess.
- Rlv. Mureto Ess.
- Rlv. Caen Ess.
- Rlv. Mery Ess.
- Rlv. Gales Ess.
- Rlv. Gobi Ess.
- Rlv. Hanna Ess.
- Rlv. Nantes Ess.
- Rlv. Chevron Ess.
- Rlv. Poppins Ess.
- Rlv. Romagna I&O
- Bercy Ess.**
- Oxitrace Ess.**
- Rapolano I&O.**
- Wonder Ess.**

PORCEGLASS PORCELAIN



Ess. Rlv. Gaudí Blanco 60x120

in&out
BY prismacer

Ess. Rlv. Gaudí

Porceglass / Porcelain



Ess. Rlv. Gaudí Blanco



Ess. Rlv. Gaudí Marfil

Formatos / Formats

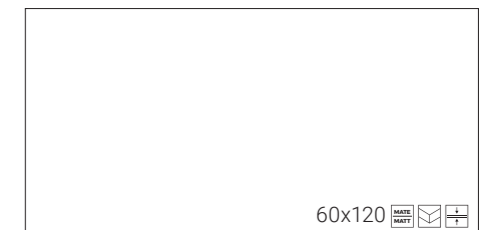

in&out

-
-
-
-
-
-
-
-

Formato	Pz/cj	Pz/pl	M ² /cj	M ² /pl	Cj/pl	Kg/cj	Kg/Total
60x120 (F)	2	72	1,44	51,84	36	29,50	1091
Porcelain	60x120 23.62"x 47.24"						



Ess. Rlv. Brick Gris 60x120

in&out
BY prismacer

Ess. Rlv. Brick

Porcelglass / Porcelain



Ess. Rlv. Brick Gris



Ess. Rlv. Brick Ocre



Ess. Rlv. Brick Cotto

Formatos / Formats

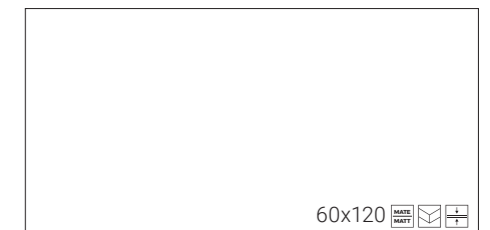

in&out

-
-
-
-
-
-
-
-
-
-
-

Formato	Pz/cj	Pz/pl	M ² /cj	M ² /pl	Cj/pl	Kg/cj	Kg/Total
60x120 (F)	2	72	1,44	51,84	36	29,50	1091
Porcelain	60x120 23.62"x 47.24"						



Ess. Rlv. Mureto Gris 60x120

in&out
BY prismacer

Ess. Rlv. Mureto

Porcelglass / Porcelain



Ess. Rlv. Mureto Gris



Ess. Rlv. Mureto Beige

Formatos / Formats

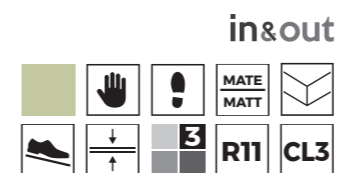
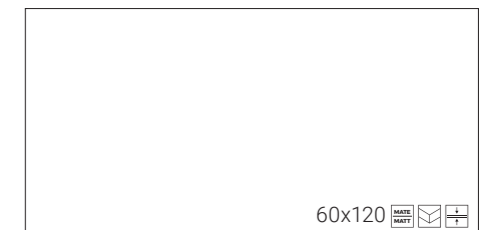

Formato	Pz/cj	Pz/pl	M ² /cj	M ² /pl	Cj/pl	Kg/cj	Kg/Total
60x120 (F)	2	72	1,44	51,84	36	29,50	1091
Porcelain	60x120 23.62"x 47.24"						



Ess. Rlv. Caen 60x120
Statuarietto 60x120

Ess. Rlv. Caen *NEW*





Ess. Rlv. Caen

Porcelglass / Porcelain

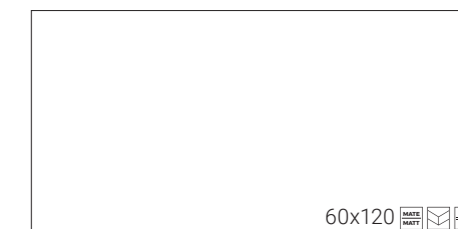
Formatos / Formats



Formato	Pz/cj	Pz/pl	M ² /cj	M ² /pl	Cj/pl	Kg/cj	Kg/Total
60x120 (F)   	2	72	1,44	51,84	36	29,50	1091
Porcelain	60x120 23.62"x 47.24"						



Ess. Rlv. Hanna







Ess. Rlv. Hanna

Porceglass / Porcelain

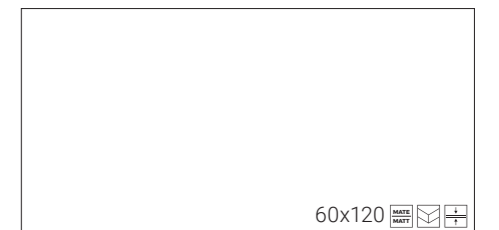
Ess. Rlv. Hanna 60x120
Miró Terra 20x120

Formatos / Formats



Formato	Pz/cj	Pz/pl	M ² /cj	M ² /pl	Cj/pl	Kg/cj	Kg/Total
60x120 (F)   	2	72	1,44	51,84	36	29,50	1091
Porcelain	60x120 23.62"x 47.24"						



Ess. Mery Gold 60x120
Ess. Rlv. Mery Gold 60x120

Ess. Mery *NEW*

Porceglass / Porcelain



Ess. Mery Gold

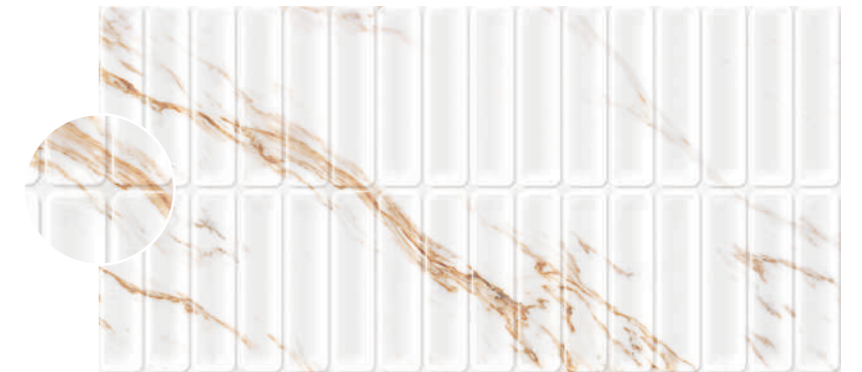

Ess. Rlv. Mery Gold

Formatos / Formats

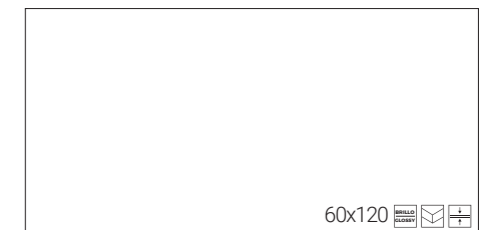

Formato	Pz/cj	Pz/pl	M ² /cj	M ² /pl	Cj/pl	Kg/cj	Kg/Total
60x120 (F)	2	72	1,44	51,84	36	29,50	1091
Porceglass	60x120 23.62"x 47.24"						



Ess. Rlv. Nantes Fuoco 60x120
Soul Cement 60x120

Ess. Rlv. Nantes

Porcelain / Porcelain

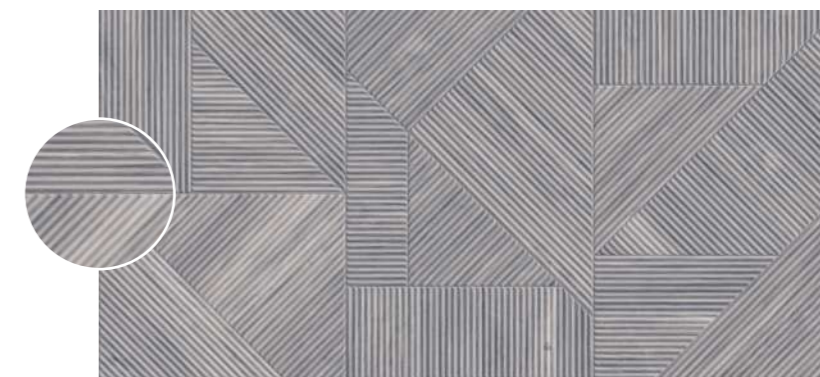

Ess. Rlv. Nantes Gris





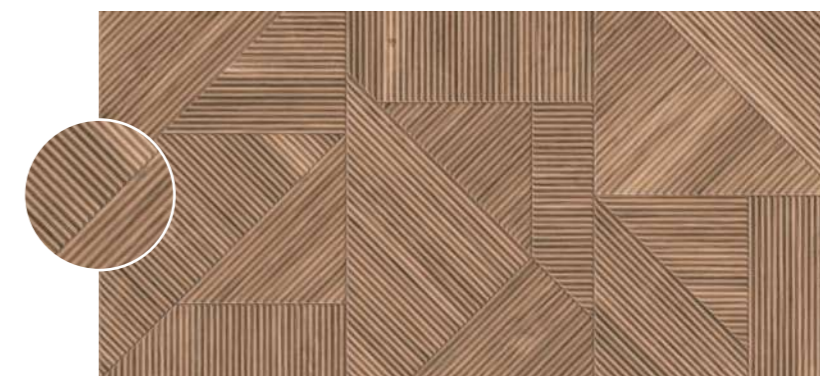

Ess. Rlv. Nantes Fuoco

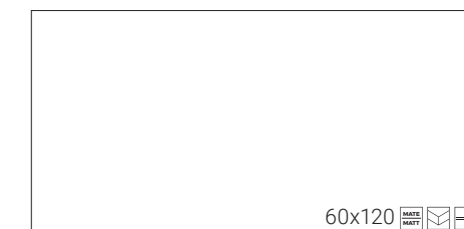

Ess. Rlv. Nantes Natura

Formatos / Formats



Formato	Pz/cj	Pz/pl	M ² /cj	M ² /pl	Cj/pl	Kg/cj	Kg/Total
60x120 (F)   	2	72	1,44	51,84	36	29,50	1091
Porcelain	60x120 23.62"x 47.24"						



Ess. Rlv. Chevron Terra 60x120

Ess. Rlv. Chevron

Porcelglass / Porcelain



Ess. Rlv. Chevron Nubole



Ess. Rlv. Chevron Terra



Ess. Rlv. Chevron Natura

Formatos / Formats

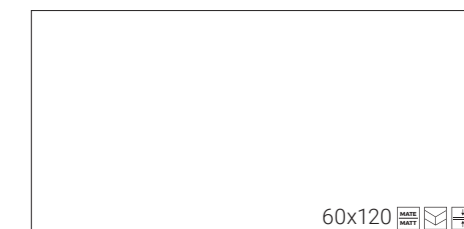

Formato	Pz/cj	Pz/pl	M ² /cj	M ² /pl	Cj/pl	Kg/cj	Kg/Total
60x120 (F)	2	72	1,44	51,84	36	29,50	1091
Porcelain	60x120 23.62"x 47.24"						



Ess. Rlv. Poppins Fuoco 60x120
Etna Marfil 120x120

Ess. Rlv. Poppins

Porcelglass / Porcelain



Ess. Rlv. Poppins Fuoco







Ess. Rlv. Poppins Terra

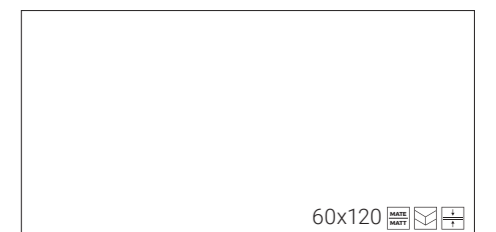

Ess. Rlv. Poppins Natura

Formatos / Formats



Formato	Pz/cj	Pz/pl	M ² /cj	M ² /pl	Cj/pl	Kg/cj	Kg/Total
60x120 (F)   	2	72	1,44	51,84	36	29,50	1091
Porcelain	60x120 23.62"x 47.24"						



I&O. Rlv. Romagna Gris 60x120

in&out
BY prismacer

I&O. Rlv. Romagna

Porcelglass / Porcelain



I&O. Rlv. Romagna Argent



I&O. Rlv. Romagna Gris



I&O. Rlv. Romagna Light



I&O. Rlv. Romagna Taupe

Formatos / Formats

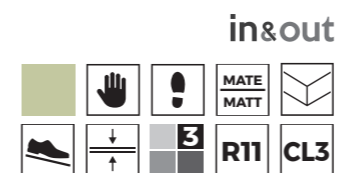
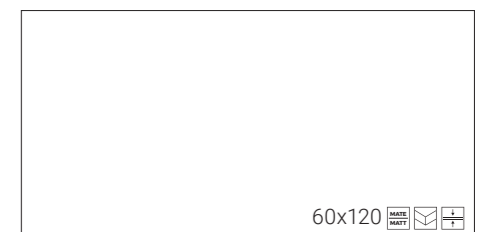

in&out

Formato	Pz/cj	Pz/pl	M ² /cj	M ² /pl	Cj/pl	Kg/cj	Kg/Total
60x120 (F)	2	72	1,44	51,84	36	29,50	1091
Porcelain	60x120 23.62"x 47.24"						

Ess. Bercy



Ess. Rlv Bercy Grigio 60x120
Ess. Bercy Grigio 60x120



Ess. Rlv. Bercy Nude



Ess. Bercy Nude



Ess. Rlv. Bercy Bianco



Ess. Bercy Bianco









Ess. Rlv. Bercy Grigio



Ess. Bercy Grigio

Formatos / Formats

60,8x60,8 	60x60 	60x120 
---	---	--

Formato	Pz/cj	Pz/pl	M ² /cj	M ² /pl	Cj/pl	Kg/cj	Kg/Total
60,8x60,8 	4	120	1,48	44,4	30	31,35	960,5
60x60 	4	120	1,44	43,2	30	30,00	920
60x120 (F) 	2	72	1,44	51,84	36	29,50	1091

Porcelain 60,8x60,8 / 60x60 / 60x120
23.94"x23.94" / 23.62"x23.62" / 23.62"x47.24"



Ess. Bercy Antracita



Ess. Bercy Blu



Ess. Bercy Salvia



Ess. Bercy Terra



Ess. Bercy Dec. Bianco 60x120

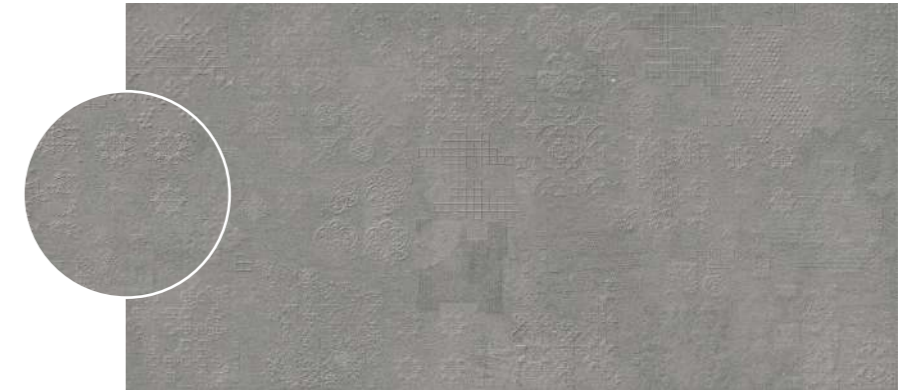

Ess. Dec. Bercy Antracita



Ess. Dec. Bercy Blu

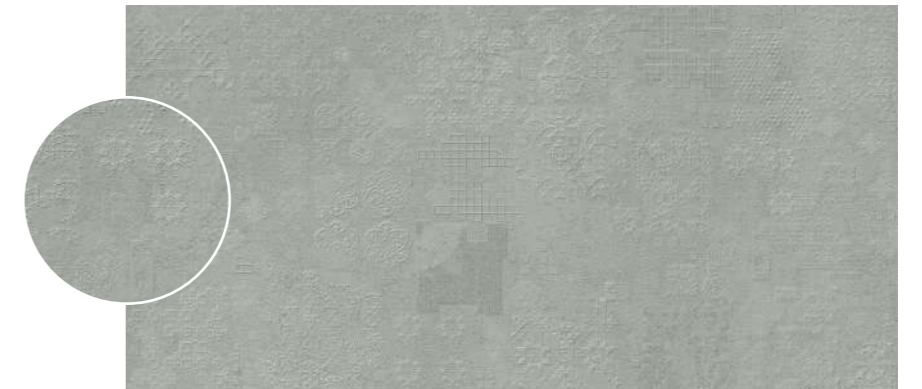

Ess. Dec. Bercy Salvia



Ess. Dec. Bercy Terra

Ess. Bercy

Porcelglass / Porcelain



Ess. Bercy Nude



Ess. Bercy Bianco



Ess. Bercy Grigio

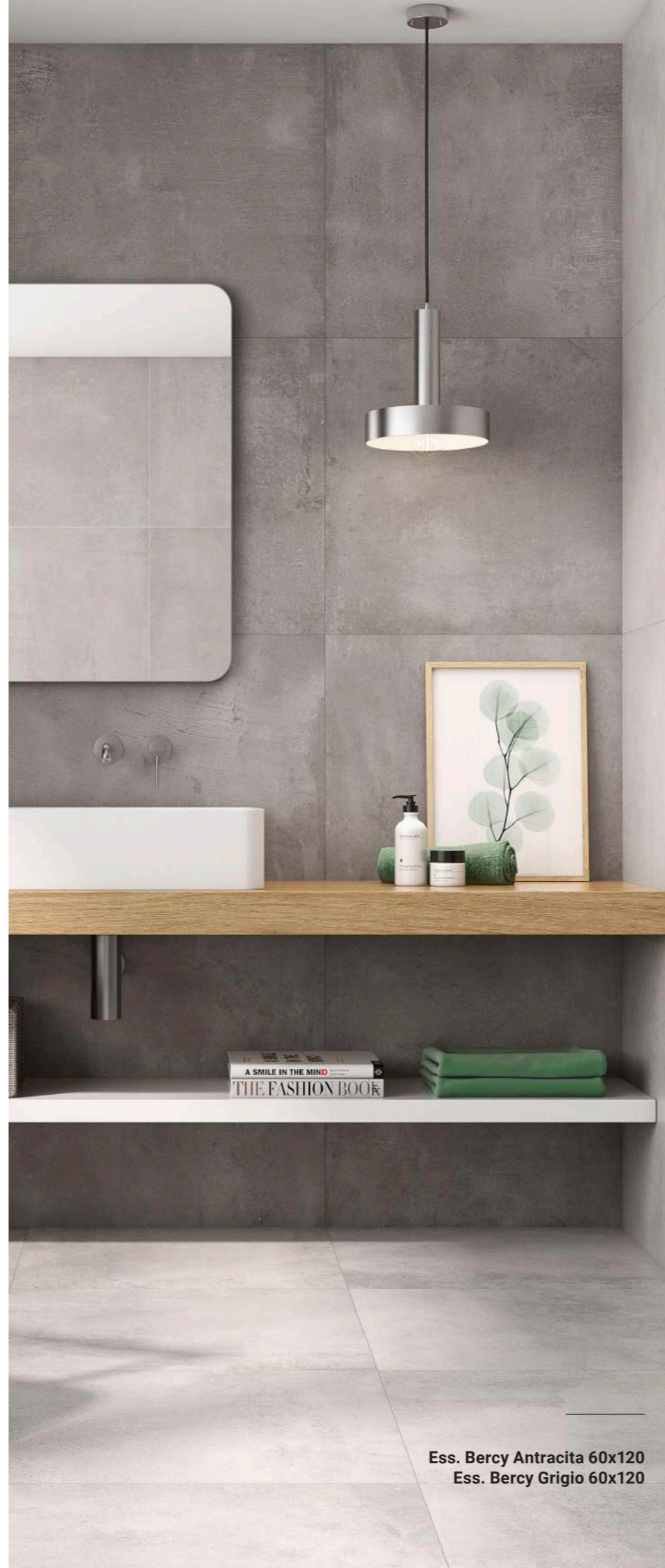

Ess. Bercy Antracita 60x120
Ess. Bercy Grigio 60x120

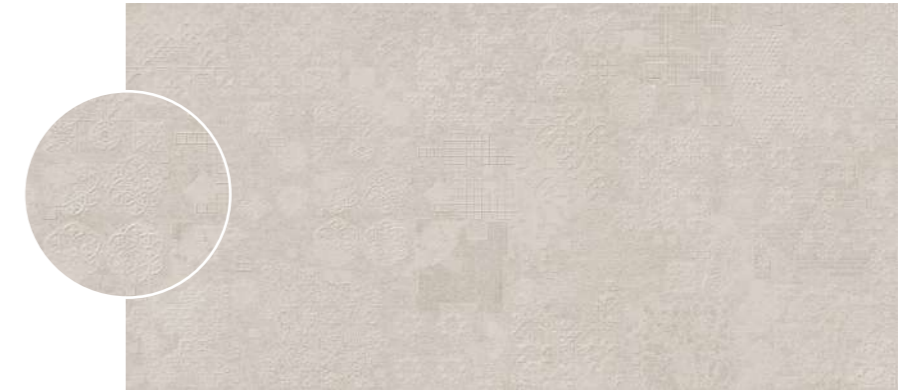

Ess. Dec. Bercy Nude

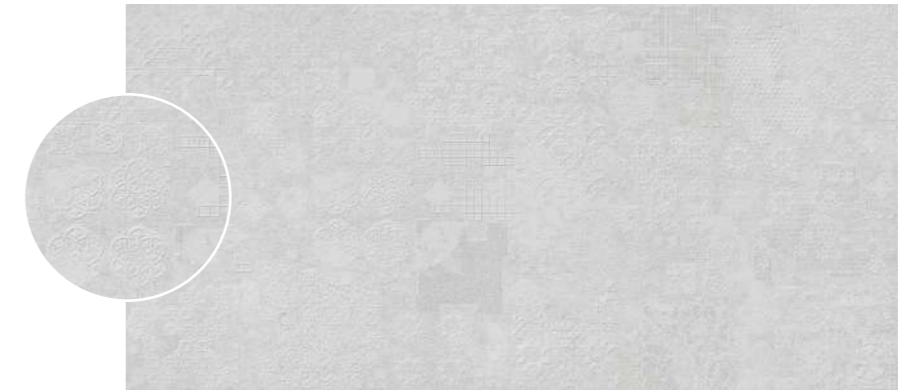

Ess. Dec. Bercy Bianco



Ess. Dec. Bercy Grigio

Ess. Gales *NEW*

Porcelglass / Porcelain



Ess. Riv. Gales Grey 60x120
Ess. Gales Grey 60x120



Ess. Gales Brown

Ess. Gales Ivory

Ess. Gales Grey

Ess. Gales Dark

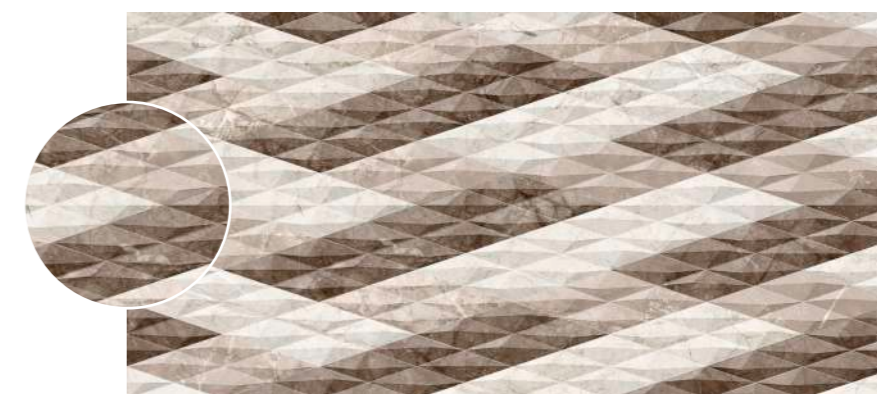

Ess. Riv. Gales Ivory

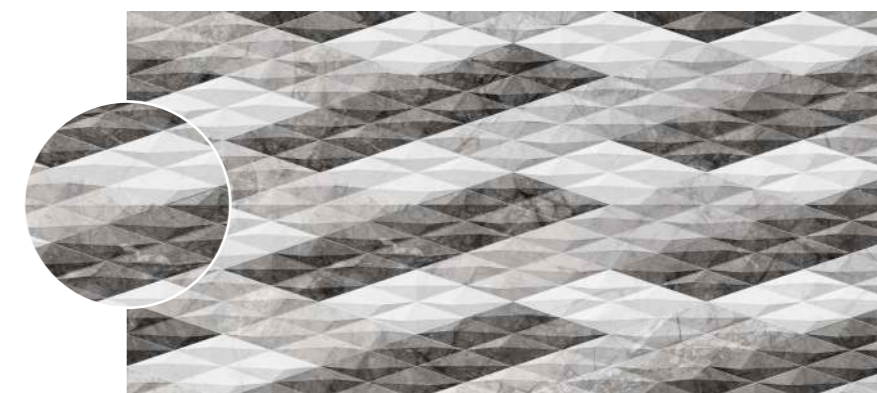

Ess. Riv. Gales Grey

Formatos / Formats



Formato	Pz/cj	Pz/pl	M ² /cj	M ² /pl	Cj/pl	Kg/cj	Kg/Total
60,8x60,8	4	120	1,48	44,4	30	31,35	960,5
60x60	4	120	1,44	43,2	30	30,00	920
75x75	3	90	1,69	50,7	30	41,20	1256
90x90	2	54	1,62	43,74	27	40,00	1110
60x120 (F)	2	72	1,44	51,84	36	29,50	1091

Porcelglass 60x60 / 60,8x60,8 / 75x75 / 90x90 / 60x120
23.62"x23.62" / 23.94"x23.94" / 29.52"x29.52"
35.43"x35.43" / 23.62"x47.24"



Ess. Gobi Bianco 60x120
Ess. Gobi Bianco 60x60

Ess. Gobi *NEW*

Porcelain / Porcelain

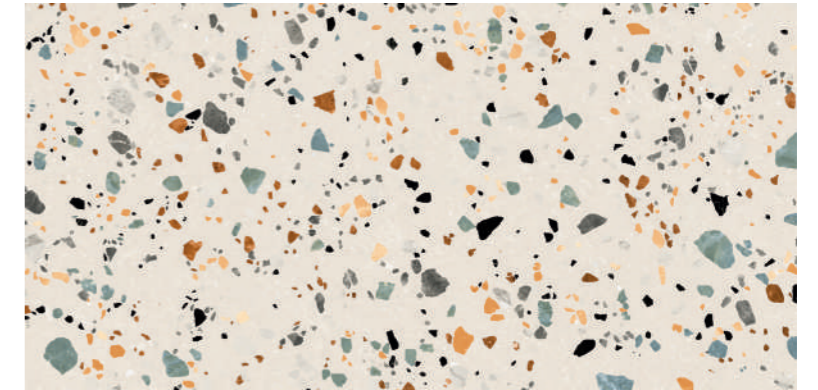

Ess. Gobi Nude

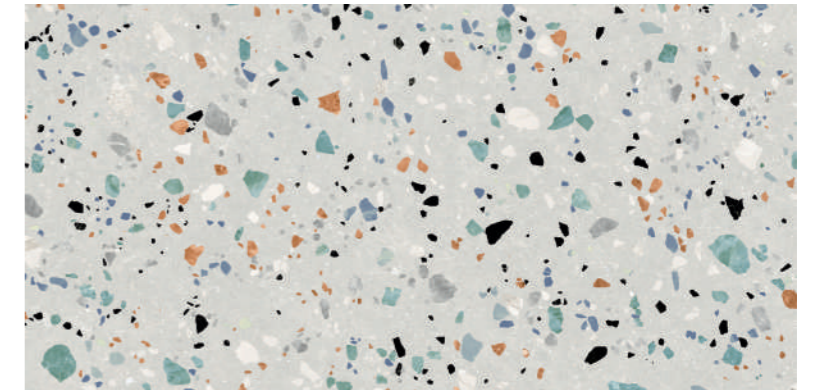

Ess. Gobi Bianco

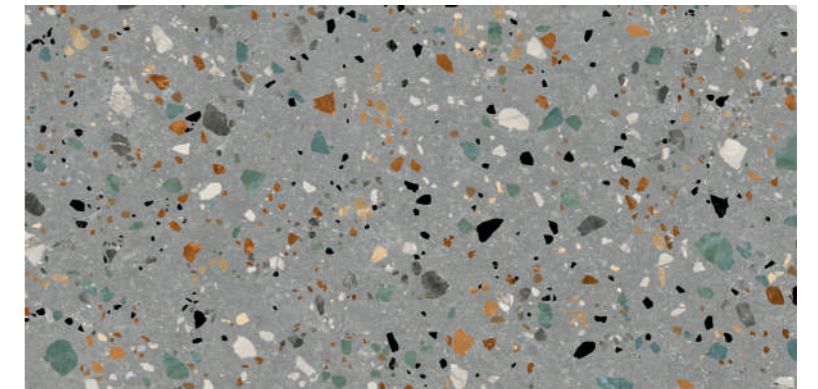

Ess. Gobi Grigio

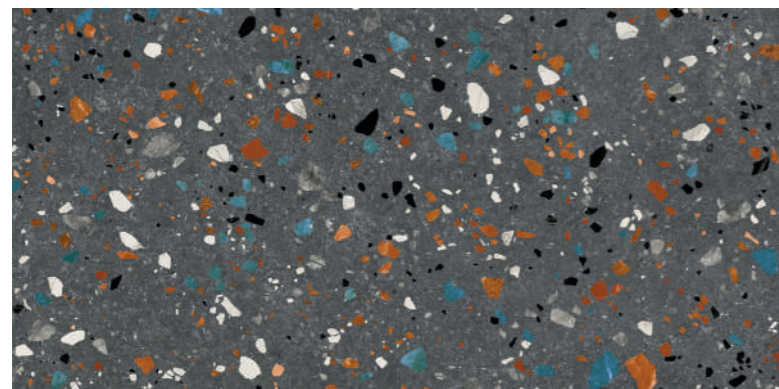

Ess. Gobi Nero

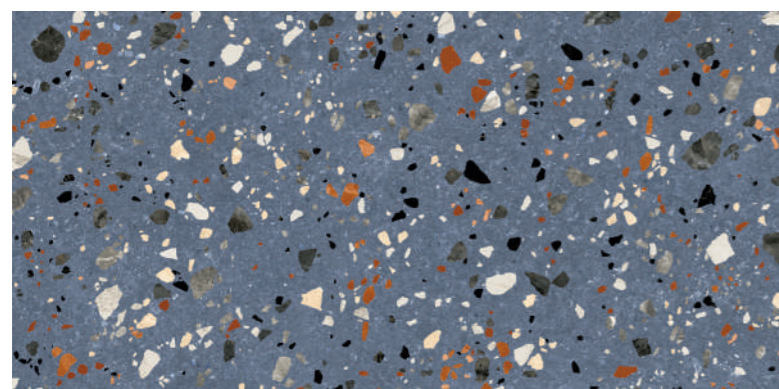

Ess. Gobi Blu

Formatos / Formats

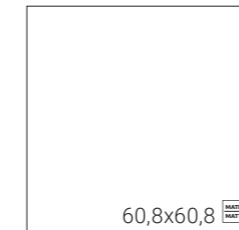

60,8x60,8

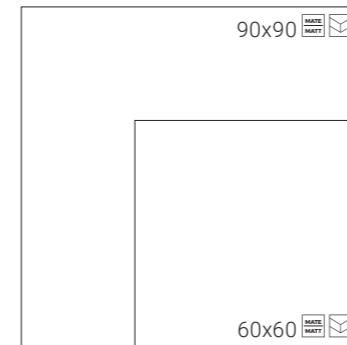

90x90



60x60

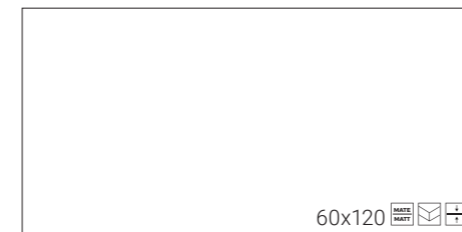

60x120



Formato	Pz/cj	Pz/pl	M ² /cj	M ² /pl	Cj/pl	Kg/cj	Kg/Total
60x60	4	120	1,44	43,2	30	30,00	920
60,8x60,8	4	120	1,48	44,4	30	31,35	960,5
90x90	2	54	1,62	43,74	27	40,00	1110
60x120 (F)	2	72	1,44	51,84	36	29,50	1091

Porcelain 60x60 / 60,8x60,8 / 90x90 / 60x120
23.62"x23.62" / 23.94"x23.94" / 35.43"x35.43" / 23.62"x47.24"



Ess. Gobi Grigio 60x120
Ess. Rlv. Gobi Grigio 60x120

Ess. Rlv. Gobi *NEW*



Ess. Rlv. Gobi Nude



Ess. Rlv. Gobi Bianco

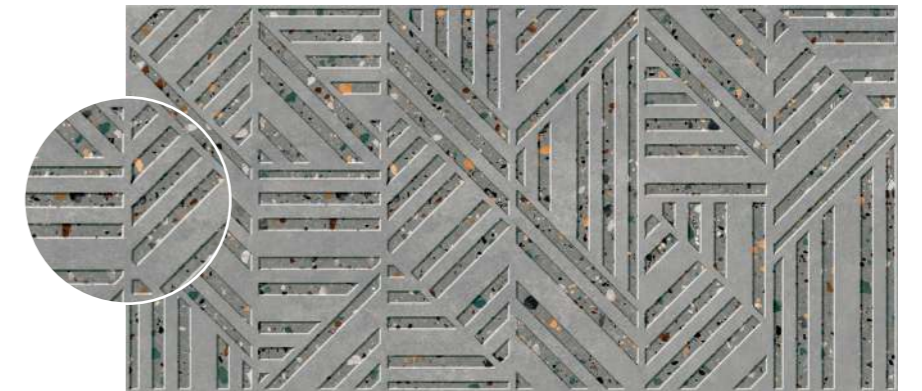

Ess. Rlv. Gobi Grigio

Ess. Oxitrace

Porcelain / Porcelain



Ess. Rlv. Oxitrace Oxid 60x120
Oxitrace Nacar 60x120
Oxitrace Oxid 60x120



Ess. Oxitrace Nacar

Ess. Oxitrace Oxid

Ess. Oxitrace Dark

Ess. Oxitrace Grey



Ess. Rlv. Oxitrace Oxid



Ess. Rlv. Oxitrace Dark

Formatos / Formats



60x60

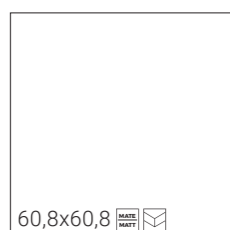

60,8x60,8



60x120



Formato	Pz/cj	Pz/pl	M ² /cj	M ² /pl	Cj/pl	Kg/cj	Kg/Total
60x60	4	120	1,44	43,2	30	30,00	920
60,8x60,8	4	120	1,48	44,4	30	31,35	960,5
60x120 (F)	2	72	1,44	51,84	36	29,50	1091
Porcelain	60x60 / 60,8x60,8 / 60x120 23.62"x 23.62" / 23.93"x 23.93" / 23.62"x 47.24"						



Rlv. Rapolano Beige



* Rapolano Beige



Rlv. Rapolano Gris



* Rapolano Gris

Formatos / Formats

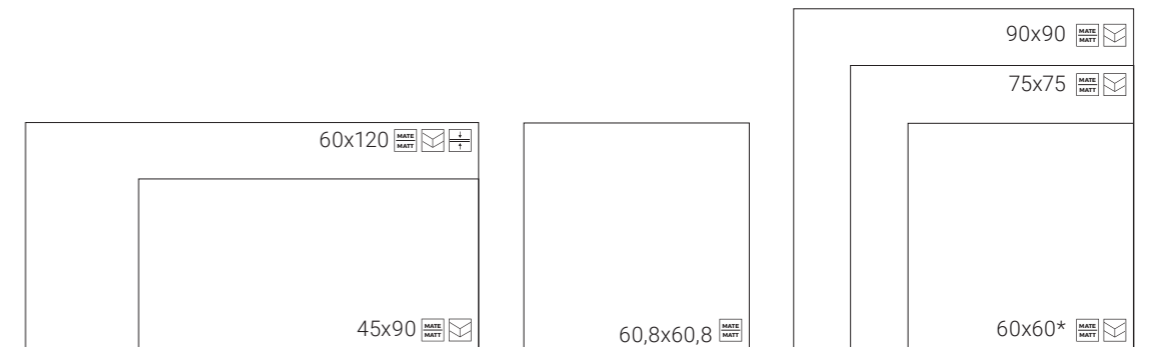

Formato	Pz/cj	Pz/pl	M ² /cj	M ² /pl	Cj/pl	Kg/cj	Kg/Total
45x90	3	132	1,21	53,24	44	28,70	1282,8
60x60*	4	120	1,44	43,2	30	30,00	920
60x120 (F)	2	72	1,44	51,84	36	29,50	1091
60,8x60,8	4	120	1,48	44,4	30	31,35	960,5
75x75	3	90	1,69	50,7	30	41,20	1256
90x90	2	54	1,62	43,74	27	40,00	1110

Porcelain 45x90 / 60x60 / 60x120 / 60,8x60,8 / 75x75 / 90x90
17.72"x35.43" / 23.62"x 23.62" / 23.62"x 47.24" /
23.93"x23.94" / 29.53"x29.53" / 35.43"x35.43"

I&O. Rlv Rapolano Gris 60x120
I&O. Rapolano Gris 60x60



Ess. Wonder Mud 60x120
Ess. Rlv. Wonder Mud 60x120

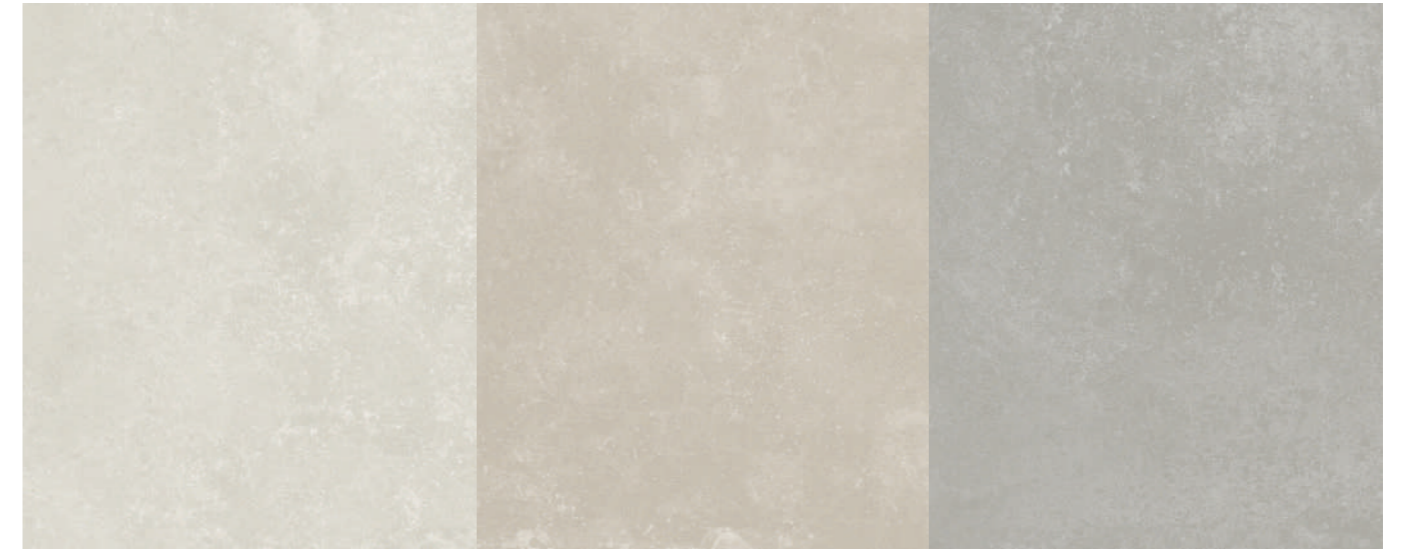

Ess. Wonder Base

Ess. Wonder Mud

Ess. Wonder Gris



Ess. Rlv. Wonder Base



Ess. Rlv. Wonder Mud



Ess. Rlv. Wonder Gris

Formatos / Formats



Formato	Pz/cj	Pz/pl	M ² /cj	M ² /pl	Cj/pl	Kg/cj	Kg/Total
45x45	6	312	1,22	63,44	52	25,80	1361,6
60x60*	4	120	1,44	43,2	30	30,00	920
60,8x60,8*	4	120	1,48	44,4	30	31,35	960,5
60x120 (F)	2	72	1,44	51,84	36	29,50	1091
90x90	2	54	1,62	43,74	27	40,00	1110
75x75	3	90	1,69	50,7	30	41,20	1256

Porcelain 60x60 / 60,8x60,8 / 60x120 / 90x90 / 75x75
23.62"x23.62" / 23.94"x23.94" / 23.62"x47.24" / 35.43"x35.43" / 29.53"x29.53"

Características técnicas

Technical characteristics Caractéristiques techniques

Porcelain

Revestimiento Monoporosa / Wall Tiles

GRUPO BIII (GL) Absorción de agua > 10% GROUP BIII (GL) Water absorption > 10% GROUPE BIII (GL) Absorption d'eau > 10%	NORMAS DE ENSAYO STANDARD / NORMES D'ESSAI	VALORES PRESCRITOS NORMA EN 14411 VALUE REQUIRED BY EN 14411 STANDARD / VALEURS PRESCRITES NORME EN 14411	VALOR MEDIO AVERAGE VALUE / VALEUR MOYENNE
Características dimensionales Dimensional features / Caractéristiques dimensionnelles	ISO 10545-2	> 10 %	Cumple la norma Conforms to standard / Satisfait à la norme
Absorción de agua Water absorption / Absorption d'eau	ISO 10545-3	> 15 N / mm ²	16%
Resistencia a la flexión Modulus of rupture / Résistance à la flexion	ISO 10545-4	> 600 N	20 - 30 N / mm ² 700 - 1000 N
Resistencia a la abrasión superficial Resistance to surface abrasion / Résistance à l'abrasion de surface	ISO 10545-7	Clase indicada por el fabricante Abrasion class indicated by the manufacturer / Classe indiquée par le fabricant	No aplica Not apply / Non applicable
Dilatación térmica lineal Linear thermal expansion / Dilatation thermique linéaire	ISO 10545-8	Método de ensayo disponible Test method available / Méthode d'essai disponible	<7,0 x 10 ⁻⁶ °C ⁻¹
Resistencia al choque térmico Thermal shock resistance / Résistance au choc thermique	ISO 10545-9	Método de ensayo disponible Test method available / Méthode d'essai disponible	Resiste Resists / Résiste
Resistencia al cuarteo Crazing resistance / Résistance au tressailage	ISO 10545-11	Exigida Required / Exigée	Resiste Resists / Résiste
Resistencia química Chemical resistance / Résistance chimique	ISO 10545-13	Método de ensayo disponible Test method available / Méthode d'essai disponible Mínimo GB Minimum GB / Minimum GB	Cumple la norma Conforms to standard / Satisfait à la norme Clase GA Class GA / Classe GA
Resistencia a las manchas Resistance to stains / Résistance aux taches	ISO 10545-14	Mínimo clase 3 Minimum class 3 / Minimum classe 3	Cumple la norma Conforms to standard / Satisfait à la norme

GRUPO BIa (GL) Absorción de agua < 0,5% GROUP BIa (GL) Water absorption < 0,5% GROUPE BIa (GL) Absorption d'eau < 0,5%	NORMAS DE ENSAYO STANDARD / NORMES D'ESSAI	VALORES PRESCRITOS NORMA EN 14411 VALUE REQUIRED BY EN 14411 STANDARD / VALEURS PRESCRITES NORME EN 14411	VALOR MEDIO AVERAGE VALUE / VALEUR MOYENNE
Características dimensionales Dimensional features / Caractéristiques dimensionnelles	ISO 10545-2		Cumple la norma Conforms to standard / Satisfait à la norme
Absorción de agua Water absorption / Absorption d'eau	ISO 10545-3	> 35 N / mm ² / 5%	0,1%
Resistencia a la flexión Modulus of rupture / Résistance à la flexion	ISO 10545-4	> 1300 N	35 - 45 N / mm ² 1800 - 2500 N
Resistencia a la abrasión superficial Resistance to surface abrasion / Résistance à l'abrasion de surface	ISO 10545-7	Clase indicada por el fabricante Abrasion class indicated by the manufacturer / Classe indiquée par le fabricant	No aplica Not apply / Non applicable
Dilatación térmica lineal Linear thermal expansion / Dilatation thermique linéaire	ISO 10545-8	Método de ensayo disponible Test method available / Méthode d'essai disponible	<7,0 x 10 ⁻⁶ °C ⁻¹
Resistencia al choque térmico Thermal shock resistance / Résistance au choc thermique	ISO 10545-9	Método de ensayo disponible Test method available / Méthode d'essai disponible	Resiste Resists / Résiste
Resistencia al cuarteo Crazing resistance / Résistance au tressailage	ISO 10545-11	Exigida Required / Exigée	Resiste Resists / Résiste
Resistencia a la helada / Frost resistance / Résistance au gel	ISO 10545-12	Método de ensayo disponible Test method available / Méthode d'essai disponible	Resiste Resists / Résiste
Resistencia química Chemical resistance / Résistance chimique	ISO 10545-13	Método de ensayo disponible Test method available / Méthode d'essai disponible Mínimo GB Minimum GB / Minimum GB	Cumple la norma Conforms to standard / Satisfait à la norme Clase GA Class GA / Classe GA
Resistencia a las manchas Resistance to stains / Résistance aux taches	ISO 10545-14	Mínimo clase 3 Minimum class 3 / Minimum classe 3	Cumple la norma Conforms to standard / Satisfait à la norme

Porcelux

GRUPO BIa (GL) Absorción de agua 0,5% < E< 3% GROUPE BIa (GL) Water absorption 0,5% < E< 3% GROUPE BIa (GL) Absorption d'eau 0,5% < E< 3%	NORMAS DE ENSAYO STANDARD / NORMES D'ESSAI	VALORES PRESCRITOS NORMA EN 14411 VALUE REQUIRED BY EN 14411 STANDARD / VALEURS PRESCRITES NORME EN 14411	VALOR MEDIO AVERAGE VALUE / VALEUR MOYENNE
Características dimensionales Dimensional features / Caractéristiques dimensionnelles	ISO 10545-2		Cumple la norma Conforms to standard / Satisfait à la norme
Absorción de agua Water absorption / Absorption d'eau	ISO 10545-3	BIa < 0,5%	0,1%
Resistencia a la flexión Modulus of rupture / Résistance à la flexion	ISO 10545-4	> 30 N / mm ² > 1100 N	35 - 45 N / mm ² 1800 - 2500 N
Resistencia a la abrasión superficial Resistance to surface abrasion / Résistance à l'abrasion de surface	ISO 10545-7	Clase indicada por el fabricante Abrasion class indicated by the manufacturer / Classe indiquée par le fabricant	Según Modelos According to models / Selon modèles
Dilatación térmica lineal Linear thermal expansion / Dilatation thermique linéaire	ISO 10545-8	Método de ensayo disponible Test method available / Méthode d'essai disponible	<7,0 x 10 ⁻⁶ °C ⁻¹
Resistencia al choque térmico Thermal shock resistance / Résistance au choc thermique	ISO 10545-9	Método de ensayo disponible Test method available / Méthode d'essai disponible	Resiste Resists / Résiste
Resistencia al cuarteo Crazing resistance / Résistance au tressailage	ISO 10545-11	Exigida Required / Exigée	Resiste Resists / Résiste
Resistencia química Chemical resistance / Résistance chimique	ISO 10545-13	Método de ensayo disponible Test method available / Méthode d'essai disponible Mínimo GB Minimum GB / Minimum GB	Cumple la norma Conforms to standard / Satisfait à la norme Clase GA Class GA / Classe GA
Resistencia a las manchas Resistance to stains / Résistance aux taches	ISO 10545-14	Mínimo clase 3 Minimum class 3 / Minimum classe 3	Cumple la norma Conforms to standard / Satisfait à la norme

Porcebloc

GRUPO BIa (UGL) Absorción de agua < 0,5% GROUPE BIa (UGL) Water absorption < 0,5% GROUPE BIa (UGL) Absorption d'eau < 0,5%	NORMAS DE ENSAYO STANDARD / NORMES D'ESSAI	VALORES PRESCRITOS NORMA EN 14411 VALUE REQUIRED BY EN 14411 STANDARD / VALEURS PRESCRITES NORME EN 14411	VALOR MEDIO AVERAGE VALUE / VALEUR MOYENNE
Características dimensionales Dimensional features / Caractéristiques dimensionnelles	ISO 10545-2		Cumple la norma Conforms to standard / Satisfait à la norme
Absorción de agua Water absorption / Absorption d'eau	ISO 10545-3	< 0,5%	0,1%
Resistencia a la flexión Modulus of rupture / Résistance à la flexion	ISO 10545-4	> 35 N / mm ² > 1300 N	35 - 45 N / mm ² 1800 - 2500 N
Resistencia a la abrasión profunda (mm³) Resistance to deep abrasion (mm ³) / Résistance à l'abrasion profonde (mm ³)	ISO 10545-6	Máx. 175 mm³	110 - 130 mm³
Dilatación térmica lineal Linear thermal expansion / Dilatation thermique linéaire	ISO 10545-8	Método de ensayo disponible Test method available / Méthode d'essai disponible	<7,0 x 10 ⁻⁶ °C ⁻¹
Resistencia al choque térmico Thermal shock resistance / Résistance au choc thermique	ISO 10545-9	Método de ensayo disponible Test method available / Méthode d'essai disponible	Resiste Resists / Résiste
Resistencia a la helada Frost resistance / Résistance au gel	ISO 10545-12	Método de ensayo disponible Test method available / Méthode d'essai disponible	Resiste Resists / Résiste
Resistencia química Chemical resistance / Résistance chimique	ISO 10545-13	Método de ensayo disponible Test method available / Méthode d'essai disponible Mínimo UB Minimum UB / Minimum UB	Cumple la norma Conforms to standard / Satisfait à la norme Clase UA Class UA / Classe UA
Resistencia a las manchas Resistance to stains / Résistance aux taches	ISO 10545-14	Mínimo clase 3 Minimum class 3 / Minimum classe 3	Cumple la norma Conforms to standard / Satisfait à la norme
Resistencia al deslizamiento Slip Resistance / Résistance au glissement	DIN 51130 UNE-ENV 12633 ASTM C 1028		Según Modelos According to models / Selon modèles

PRISSMACER CERÁMICA S.L.U.

Camino Ratils, 23 Polígono Industrial Colomer, 12200 Onda, Castellón
(España) Tel: (+34) 964 500 226 - info@prissmacer.es - @prissmacer_tiles
www.prissmacer.es

RECOMENDACIONES PARA LA LIMPIEZA DE DECORADOS Y PIEZAS ESPECIALES

Debido a las características de los metales utilizados en la confección de estos productos. Es suficiente utilizar una bayeta húmeda y jabón líquido neutro. Si la pieza llevara protección no quitarla hasta que el producto esté colocado y limpio. No se atenderán reclamaciones una vez colocado el producto.

RECOMMENDATIONS FOR THE CLEANING OF DECORATIVE AND SPECIAL PIECES

Due to the characteristics of the metals used in the production of these pieces, only a damp cloth and neutral liquid soap are required to clean them. Any protective material should be left on the piece until it is fitted and clean. Complaints will not be considered once the product has been fitted.

RECOMMANDATIONS CONCERNANT LE NETTOYAGE DES DECORS ET PIECES SPECIALES

Dues aux caractéristiques des métaux utilisés lors de la confection de ses produits, il est suffisant d'utiliser une éponge humide et du savon neutre. Dans le cas où la pièce porterait une protection, ne pas l'enlever jusqu'à ce que le produit soit posé et nettoyé. Aucune réclamation ne sera acceptée une fois le produit Pamesa posé.

PRISSMACER CERÁMICA S.L.U. aplica una política de continuo desarrollo de sus productos y se reserva el derecho a realizar cambios en los productos, colores, especificaciones técnicas, packings y códigos sin previo aviso. PRISSMACER CERÁMICA S.L.U. ha realizado un esfuerzo considerable para que toda la información sea adecuada en el momento de la publicación del catálogo. A causa de las limitaciones del proceso de impresión los colores reproducidos pueden sufrir ligeras variaciones con respecto al producto original. PRISSMACER CERÁMICA S.L.U. informa que este catálogo tiene validez a nivel informativo y por tanto no se hace responsable de los posibles errores de impresión; reservándose el derecho de realizar modificaciones sin necesidad de preaviso.

PRISSMACER CERÁMICA S.L.U. operates a policy of continuous development and reserves the right to make changes to its products, colours, engineering specifications, packaging and codes without prior notice. PRISSMACER CERÁMICA S.L.U. has taken every effort to ensure that the information contained in the catalogue is correct at the time of publication. Due to the limitations of the printing process, the colours reproduced may vary slightly from the original product. PRISSMACER CERÁMICA S.L.U. advises that this catalogue is only valid for information purposes and therefore does not accept responsibility for any possible printing errors.

PRISSMACER CERÁMICA S.L.U. applique une politique de développement continu de ses produits et se réserve le droit de réaliser des changements, que ce soit de produits, couleurs, spécifications techniques, paquetages et codifications et cela sans en aviser préalablement l'acheteur. PRISSMACER CERÁMICA S.L.U. a réalisé un effort considérable pour que toute l'information donnée soit adéquate au moment de la publication du catalogue. Dues aux limitations du processus d'impression, les couleurs reproduites peuvent souffrir de légères variations avec le produit original. PRISSMACER CERÁMICA S.L.U. vous informe que les informations de ce catalogue sont données à titre informatif et qu'elle n'est pas responsable des possibles erreurs d'impression. De plus, elle se réserve le droit de modifier les informations sans préavis.